



# Artix™

---

## Security Guide

Version 4.0, March 2006

IONA Technologies PLC and/or its subsidiaries may have patents, patent applications, trademarks, copyrights, or other intellectual property rights covering subject matter in this publication. Except as expressly provided in any written license agreement from IONA Technologies PLC, the furnishing of this publication does not give you any license to these patents, trademarks, copyrights, or other intellectual property. Any rights not expressly granted herein are reserved.

IONA, IONA Technologies, the IONA logo, Orbix, Orbix Mainframe, Orbix Connect, Artix, Artix Mainframe, Artix Mainframe Developer, Mobile Orchestrator, Orbix/E, Orbacus, Enterprise Integrator, Adaptive Runtime Technology, and Making Software Work Together are trademarks or registered trademarks of IONA Technologies PLC and/or its subsidiaries.

Java and J2EE are trademarks or registered trademarks of Sun Microsystems, Inc. in the United States and other countries. CORBA is a trademark or registered trademark of the Object Management Group, Inc. in the United States and other countries. All other trademarks that appear herein are the property of their respective owners.

This product includes software developed by the OpenSSL Project for use in the OpenSSL Toolkit (<http://www.openssl.org>).

This product includes cryptographic software written by Eric Young ([eay@cryptsoft.com](mailto:eay@cryptsoft.com))

This product includes software written by Tim Hudson ([tjh@cryptsoft.com](mailto:tjh@cryptsoft.com)).

While the information in this publication is believed to be accurate, IONA Technologies PLC makes no warranty of any kind to this material including, but not limited to, the implied warranties of merchantability and fitness for a particular purpose. IONA shall not be liable for errors contained herein, or for incidental or consequential damages in connection with the furnishing, performance or use of this material.

---

#### COPYRIGHT NOTICE

No part of this publication may be reproduced, stored in a retrieval system or transmitted, in any form or by any means, photocopying, recording or otherwise, without prior written consent of IONA Technologies PLC. No third-party intellectual property right liability is assumed with respect to the use of the information contained herein. IONA Technologies PLC assumes no responsibility for errors or omissions contained in this publication. This publication and features described herein are subject to change without notice.

Copyright © 2003–2006 IONA Technologies PLC. All rights reserved.

All products or services mentioned in this publication are covered by the trademarks, service marks, or product names as designated by the companies that market those products.

Updated: 04-Jul-2006

# Contents

<b>List of Tables</b>	<b>xi</b>
<b>List of Figures</b>	<b>xiii</b>
<b>Preface</b>	<b>xv</b>
<b>What is Covered in this Book</b>	<b>xv</b>
<b>Who Should Read this Book</b>	<b>xv</b>
<b>The Artix Library</b>	<b>xv</b>
<b>Getting the Latest Version</b>	<b>xviii</b>
<b>Searching the Artix Library</b>	<b>xviii</b>
<b>Artix Online Help</b>	<b>xviii</b>
<b>Artix Glossary</b>	<b>xix</b>
<b>Additional Resources</b>	<b>xix</b>
<b>Document Conventions</b>	<b>xx</b>
<b>Chapter 1 Getting Started with Artix Security</b>	<b>1</b>
<b>Secure SOAP Example</b>	<b>2</b>
Secure Hello World Example	3
HTTPS Connection	6
IIOP/TLS Connection	11
Security Layer	18
<b>Secure Container Example</b>	<b>24</b>
<b>Debugging with the openssl Utility</b>	<b>31</b>
<b>Chapter 2 Introduction to the Artix Security Framework</b>	<b>37</b>
<b>Artix Security Architecture</b>	<b>38</b>
Types of Security Credential	39
Protocol Layers	41
Security Layer	43
Using Multiple Bindings	44
<b>Caching of Credentials</b>	<b>45</b>

<b>Chapter 3</b>	<b>Security for HTTP-Compatible Bindings</b>	<b>47</b>
	Overview of HTTP Security	48
	Securing HTTP Communications with SSL/TLS	51
	HTTP Basic Authentication	62
	X.509 Certificate-Based Authentication	66
<b>Chapter 4</b>	<b>Security for SOAP Bindings</b>	<b>71</b>
	Overview of SOAP Security	72
	WSSE X.509 Certificates and Authentication	76
<b>Chapter 5</b>	<b>Security for CORBA Bindings</b>	<b>81</b>
	Overview of CORBA Security	82
	Securing IIOP Communications with SSL/TLS	84
	Securing Two-Tier CORBA Systems with CSI	90
	Securing Three-Tier CORBA Systems with CSI	96
	X.509 Certificate-Based Authentication for CORBA Bindings	102
<b>Chapter 6</b>	<b>Single Sign-On</b>	<b>109</b>
	SSO and the Login Service	110
	Username/Password-Based SSO for SOAP Bindings	113
	SSO Sample Configuration for SOAP Bindings	119
<b>Chapter 7</b>	<b>Publishing WSDL Securely</b>	<b>123</b>
	Introduction to the WSDL Publish Plug-In	124
	Deploying WSDL Publish in a Container	127
	Preprocessing Published WSDL Contracts	131
	Enabling SSL/TLS for WSDL Publish Plug-In	132
<b>Chapter 8</b>	<b>Configuring the Artix Security Plug-In</b>	<b>137</b>
	The Artix Security Plug-In	138
	Configuring an Artix Configuration File	139
	Configuring a WSDL Contract	141
<b>Chapter 9</b>	<b>Configuring the Artix Security Service</b>	<b>145</b>
	Configuring the Security Service	146
	Security Service Accessible through IIOP/TLS	147
	Security Service Accessible through HTTPS	156

<b>Configuring the File Adapter</b>	<b>167</b>
<b>Configuring the LDAP Adapter</b>	<b>169</b>
<b>Configuring the Kerberos Adapter</b>	<b>175</b>
<b>Clustering and Federation</b>	<b>179</b>
Federating the Artix Security Service	180
Failover	185
Client Load Balancing	193
<b>Additional Security Configuration</b>	<b>196</b>
Configuring Single Sign-On Properties	197
Configuring the Log4J Logging	199
<b>Chapter 10 Managing Users, Roles and Domains</b>	<b>201</b>
<b>Introduction to Domains and Realms</b>	<b>202</b>
Artix security domains	203
Artix Authorization Realms	205
<b>Managing a File Security Domain</b>	<b>210</b>
<b>Managing an LDAP Security Domain</b>	<b>214</b>
<b>Chapter 11 Managing Access Control Lists</b>	<b>215</b>
<b>Overview of Artix ACL Files</b>	<b>216</b>
<b>ACL File Format</b>	<b>217</b>
<b>Generating ACL Files</b>	<b>220</b>
<b>Deploying ACL Files</b>	<b>223</b>
<b>Chapter 12 Managing Certificates</b>	<b>225</b>
<b>What are X.509 Certificates?</b>	<b>226</b>
<b>Certification Authorities</b>	<b>228</b>
Commercial Certification Authorities	229
Private Certification Authorities	230
<b>Certificate Chaining</b>	<b>231</b>
<b>PKCS#12 Files</b>	<b>233</b>
<b>Creating Your Own Certificates</b>	<b>235</b>
Set Up Your Own CA	236
Use the CA to Create Signed Certificates	239
<b>Generating a Certificate Revocation List</b>	<b>242</b>
<b>Deploying Certificates</b>	<b>245</b>
Overview of Certificate Deployment	246
Deploying Trusted Certificate Authority Certificates	248

Deploying Application Certificates	254
<b>Chapter 13 Configuring HTTPS and IOP/TLS Authentication</b>	<b>259</b>
<b>Requiring Authentication</b>	<b>260</b>
Target-Only Authentication	261
Mutual Authentication	264
<b>Specifying Trusted CA Certificates</b>	<b>267</b>
<b>Specifying an Application's Own Certificate</b>	<b>268</b>
<b>Providing a Certificate Pass Phrase</b>	<b>269</b>
Certificate Pass Phrase for HTTPS and IOP/TLS	270
<b>Specifying a Certificate Revocation List</b>	<b>272</b>
<b>Advanced Configuration Options</b>	<b>274</b>
Setting a Maximum Certificate Chain Length	275
Applying Constraints to Certificates	276
<b>Chapter 14 Configuring HTTPS and IOP/TLS Secure Associations</b>	<b>279</b>
<b>Overview of Secure Associations</b>	<b>280</b>
<b>Setting Association Options</b>	<b>282</b>
Secure Invocation Policies	283
Association Options	285
Choosing Client Behavior	287
Choosing Target Behavior	289
Hints for Setting Association Options	291
<b>Specifying Cipher Suites</b>	<b>295</b>
Supported Cipher Suites	296
Setting the Mechanism Policy	299
Constraints Imposed on Cipher Suites	302
<b>Caching Sessions</b>	<b>305</b>
<b>Chapter 15 Principal Propagation</b>	<b>307</b>
<b>Introduction to Principal Propagation</b>	<b>308</b>
<b>Configuring</b>	<b>309</b>
<b>Programming</b>	<b>312</b>
<b>Interoperating with .NET</b>	<b>315</b>
Explicitly Declaring the Principal Header	316
Modifying the SOAP Header	318

<b>Chapter 16 Bridging between SOAP and CORBA</b>	<b>321</b>
<b>SOAP-to-CORBA Scenario</b>	<b>322</b>
Overview of the Secure SOAP-to-CORBA Scenario	323
SOAP Client	325
SOAP-to-CORBA Router	329
CORBA Server	335
<b>Single Sign-On SOAP-to-CORBA Scenario</b>	<b>338</b>
Overview of the Secure SSO SOAP-to-CORBA Scenario	339
SSO SOAP Client	341
SSO SOAP-to-CORBA Router	343
<b>CORBA-to-SOAP Scenario</b>	<b>345</b>
Overview of the Secure CORBA-to-SOAP Scenario	346
CORBA Client	348
CORBA-to-SOAP Router	350
SOAP Server	356
<b>Chapter 17 Programming Authentication</b>	<b>359</b>
Propagating a Username/Password Token	360
Propagating a Kerberos Token	365
Propagating an X.509 Certificate	370
<b>Chapter 18 Developing an iSF Adapter</b>	<b>375</b>
iSF Security Architecture	376
iSF Server Module Deployment Options	380
iSF Adapter Overview	382
Implementing the IS2Adapter Interface	383
Deploying the Adapter	393
Configuring iSF to Load the Adapter	394
Setting the Adapter Properties	395
Loading the Adapter Class and Associated Resource Files	396
<b>Appendix A Artix Security</b>	<b>399</b>
Applying Constraints to Certificates	401
bus:initial_contract	403
bus:security	404
initial_references	406
password_retrieval_mechanism	408
plugins:asp	409

plugins:at_http	412
plugins:atli2_tls	417
plugins:csi	418
plugins:gsp	419
plugins:http	423
plugins:https	427
plugins:iiop_tls	428
plugins:java_server	432
plugins:kdm	435
plugins:kdm_adm	437
plugins:login_client	438
plugins:login_service	439
plugins:schannel	440
plugins:security	441
plugins:wSDL_publish	444
policies	445
policies:asp	452
policies:bindings	455
policies:csi	457
policies:external_token_issuer	460
policies:https	461
policies:iiop_tls	464
policies:security_server	474
principal_sponsor	476
principal_sponsor:csi	480
principal_sponsor:https	483
<b>Appendix B iSF Configuration</b>	<b>485</b>
Properties File Syntax	486
iSF Properties File	487
Cluster Properties File	510
log4j Properties File	513
<b>Appendix C ASN.1 and Distinguished Names</b>	<b>517</b>
ASN.1	518
Distinguished Names	519



<b>Appendix D Action-Role Mapping DTD</b>	<b>523</b>
<b>Appendix E OpenSSL Utilities</b>	<b>527</b>
<b>Using OpenSSL Utilities</b>	<b>528</b>
The x509 Utility	529
The req Utility	531
The rsa Utility	533
The ca Utility	535
<b>The OpenSSL Configuration File</b>	<b>537</b>
[req] Variables	538
[ca] Variables	539
[policy] Variables	540
Example openssl.cnf File	541
<b>Appendix F bus-security C++ Context Data</b>	<b>543</b>
<b>Appendix G bus-security Java Context Data</b>	<b>549</b>
<b>Appendix H License Issues</b>	<b>555</b>
OpenSSL License	556
<b>Index</b>	<b>559</b>

## CONTENTS

# List of Tables

Table 1: The Artix Security Plug-In Configuration Variables	139
Table 2: <bus-security:security> Attributes	141
Table 3: LDAP Properties in the com.iona.isp.adapter.LDAP.param Scope	173
Table 4: Description of Different Types of Association Option	291
Table 5: Setting EstablishTrustInTarget and EstablishTrustInClient Association Options	292
Table 6: Setting Quality of Protection Association Options	293
Table 7: Setting the NoProtection Association Option	294
Table 8: Cipher Suite Definitions	297
Table 9: Association Options Supported by Cipher Suites	303
Table 10: Mechanism Policy Cipher Suites	448
Table 11: Mechanism Policy Cipher Suites	462
Table 12: Mechanism Policy Cipher Suites	468
Table 13: Commonly Used Attribute Types	520

LIST OF TABLES

# List of Figures

Figure 1: Overview of the Secure HelloWorld Example	3
Figure 2: A HTTPS Connection in the HelloWorld Example	6
Figure 3: An IIOP/TLS Connection in the HelloWorld Example	11
Figure 4: The Security Layer in the HelloWorld Example	18
Figure 5: Connecting to a Secure Container Service	24
Figure 6: Protocol Layers in a HTTP-Compatible Binding	41
Figure 7: Protocol Layers in a SOAP Binding	42
Figure 8: Protocol Layers in a CORBA Binding	42
Figure 9: Example of an Application with Multiple Bindings	44
Figure 10: HTTP-Compatible Binding Security Layers	48
Figure 11: Overview of Certificate-Based Authentication with HTTPS	66
Figure 12: Overview of Security for SOAP Bindings	72
Figure 13: Overview of Certificate-Based Authentication with WSSE	76
Figure 14: A Secure CORBA Application within the Artix Security Framework	82
Figure 15: Two-Tier CORBA System Using CSI Credentials	90
Figure 16: Three-Tier CORBA System Using CSv2	96
Figure 17: Overview of Certificate-Based Authentication	103
Figure 18: Client Requesting an SSO Token from the Login Service	111
Figure 19: Overview of Username/Password Authentication without SSO	113
Figure 20: Overview of Username/Password Authentication with SSO	114
Figure 21: Endpoints Used by the WSDL Publishing Service	124
Figure 22: WSDL Publish Plug-In Deployed in a Secure Container	127
Figure 23: HTML Page Served Up by the WSDL Publishing Service	135
Figure 24: An iSF Federation Scenario	181
Figure 25: Failover Scenario for a Cluster of Three Security Services	186
Figure 26: Architecture of an Artix security domain	203

## LIST OF FIGURES

Figure 27: Server View of Artix authorization realms	206
Figure 28: Role View of Artix authorization realms	207
Figure 29: Assignment of Realms and Roles to Users Janet and John	208
Figure 30: Locally Deployed Action-Role Mapping ACL File	216
Figure 31: A Certificate Chain of Depth 2	231
Figure 32: A Certificate Chain of Depth 3	232
Figure 33: Elements in a PKCS#12 File	233
Figure 34: Target Authentication Only	261
Figure 35: Mutual Authentication	264
Figure 36: Configuration of a Secure Association	281
Figure 37: Constraining the List of Cipher Suites	302
Figure 38: Propagating Credentials Across a SOAP-to-CORBA Router	323
Figure 39: Propagating an SSO Token Across a SOAP-to-CORBA Router	339
Figure 40: Propagating Credentials Across a CORBA-to-SOAP Router	346
Figure 41: Overview of the Artix Security Service	377
Figure 42: iSF Server Module Deployed as a CORBA Service	380
Figure 43: iSF Server Module Deployed as a Java Library	381

# Preface

## What is Covered in this Book

This book describes how to develop and configure secure Artix solutions.

## Who Should Read this Book

This book is aimed at the following kinds of reader: security administrators, C++ programmers who need to write security code and Java programmers who need to write security code.

If you would like to know more about WSDL concepts, see the Introduction to WSDL in [Getting Started with Artix](#).

## The Artix Library

The Artix documentation library is organized in the following sections:

- [Getting Started](#)
- [Designing and Developing Artix Solutions](#)
- [Configuring and Deploying Artix Solutions](#)
- [Using Artix Services](#)
- [Integrating Artix Solutions](#)
- [Integrating with Enterprise Management Systems](#)
- [Reference Documentation](#)

## Getting Started

The books in this section provide you with a background for working with Artix. They describe many of the concepts and technologies used by Artix. They include:

- [Release Notes](#) contains release-specific information about Artix.

- [Installation Guide](#) describes the prerequisites for installing Artix and the procedures for installing Artix on supported systems.
- [Getting Started with Artix](#) describes basic Artix and WSDL concepts.
- [Using Artix Designer](#) describes how to use Artix Designer to build Artix solutions.
- [Artix Technical Use Cases](#) provides a number of step-by-step examples of building common Artix solutions.

### **Designing and Developing Artix Solutions**

The books in this section go into greater depth about using Artix to solve real-world problems. They describe how Artix uses WSDL to define services, and how to use the Artix APIs to build new services. They include:

- [Building Service-Oriented Architectures with Artix](#) provides an overview of service-oriented architectures and describes how they can be implemented using Artix.
- [Understanding Artix Contracts](#) describes the components of an Artix contract. Special attention is paid to the WSDL extensions used to define Artix-specific payload formats and transports.
- [Developing Artix Applications in C++](#) discusses the technical aspects of programming applications using the C++ API.
- [Developing Advanced Artix Plug-ins in C++](#) discusses the technical aspects of implementing advanced plug-ins (for example, interceptors) using the C++ API.
- [Developing Artix Applications in Java](#) discusses the technical aspects of programming applications using the Java API.

### **Configuring and Deploying Artix Solutions**

This section includes:

- [Configuring and Deploying Artix Solutions](#) discusses how to configure and deploy Artix-enabled systems, and provides examples of typical use cases.

### **Using Artix Services**

The books in this section describe how to use the services provided with Artix:

- [Artix Locator Guide](#) discusses how to use the Artix locator.



- [Artix Session Manager Guide](#) discusses how to use the Artix session manager.
- [Artix Transactions Guide, C++](#) explains how to enable Artix C++ applications to participate in transacted operations.
- [Artix Transactions Guide, Java](#) explains how to enable Artix Java applications to participate in transacted operations.
- [Artix Security Guide](#) explains how to use the security features of Artix.

### **Integrating Artix Solutions**

The books in this section describe how to integrate Artix solutions with other middleware technologies:

- [Artix for CORBA](#) provides information on using Artix in a CORBA environment.
- [Artix for J2EE](#) provides information on using Artix to integrate with J2EE applications.

For details on integrating with Microsoft's .NET technology, see the documentation for Artix Connect.

### **Integrating with Enterprise Management Systems**

The books in this section describe how to integrate Artix solutions with a range of enterprise management systems. They include:

- [IBM Tivoli Integration Guide](#) explains how to integrate Artix with IBM Tivoli.
- [BMC Patrol Integration Guide](#) explains how to integrate Artix with BMC Patrol.
- [CA WSDM Integration Guide](#) explains how to integrate Artix with CA WSDM.

### **Reference Documentation**

These books provide detailed reference information about specific Artix APIs, WSDL extensions, configuration variables, command-line tools, and terminology. The reference documentation includes:

- [Artix Command Line Reference](#)
- [Artix Configuration Reference](#)
- [Artix WSDL Extension Reference](#)
- [Artix Java API Reference](#)
- [Artix C++ API Reference](#)

- [Artix .NET API Reference](#)
- [Artix Glossary](#)

## Getting the Latest Version

The latest updates to the Artix documentation can be found at <http://www.iona.com/support/docs>.

Compare the version dates on the web page for your product version with the date printed on the copyright page of the PDF edition of the book you are reading.

## Searching the Artix Library

You can search the online documentation by using the **Search** box at the top right of the documentation home page:

<http://www.iona.com/support/docs>

To search a particular library version, browse to the required index page, and use the **Search** box at the top right, for example:

<http://www.iona.com/support/docs/artix/4.0/index.xml>

You can also search within a particular book. To search within a HTML version of a book, use the **Search** box at the top left of the page. To search within a PDF version of a book, in Adobe Acrobat, select **Edit | Find**, and enter your search text.

## Artix Online Help

Artix Designer and the Artix Management Console include comprehensive online help, providing:

- Step-by-step instructions on how to perform important tasks
- A full search feature
- Context-sensitive help for each screen

There are two ways that you can access the online help:

- Select **Help | Help Contents** from the menu bar. Sections on Artix Designer and the Artix Management Console appear in the contents panel of the Eclipse help browser.
- Press **F1** for context-sensitive help.

In addition, there are a number of cheat sheets that guide you through the most important functionality in Artix Designer. To access these, select **Help | Cheat Sheets**.

## Artix Glossary

The [Artix Glossary](#) provides a comprehensive reference of Artix terminology. It provides quick definitions of the main Artix components and concepts. All terms are defined in the context of the development and deployment of Web services using Artix.

## Additional Resources

The [IONA Knowledge Base](http://www.iona.com/support/knowledge_base/index.xml) ([http://www.iona.com/support/knowledge\\_base/index.xml](http://www.iona.com/support/knowledge_base/index.xml)) contains helpful articles written by IONA experts about Artix and other products.

The [IONA Update Center](http://www.iona.com/support/updates/index.xml) (<http://www.iona.com/support/updates/index.xml>) contains the latest releases and patches for IONA products.

If you need help with this or any other IONA product, go to [IONA Online Support](http://www.iona.com/support/index.xml) (<http://www.iona.com/support/index.xml>).

Comments, corrections, and suggestions on IONA documentation can be sent to [docs-support@iona.com](mailto:docs-support@iona.com).

## Document Conventions

### Typographical conventions

This book uses the following typographical conventions:

<i>Fixed width</i>	Fixed width (courier font) in normal text represents portions of code and literal names of items such as classes, functions, variables, and data structures. For example, text might refer to the <code>IT_Bus: :AnyType</code> class.
	Constant width paragraphs represent code examples or information a system displays on the screen. For example:
	<pre>#include &lt;stdio.h&gt;</pre>
<i>Fixed width italic</i>	Fixed width italic words or characters in code and commands represent variable values you must supply, such as arguments to commands or path names for your particular system. For example:
	<pre>% cd /users/YourUserName</pre>
<i>Italic</i>	Italic words in normal text represent <i>emphasis</i> and introduce <i>new terms</i> .
<b>Bold</b>	Bold words in normal text represent graphical user interface components such as menu commands and dialog boxes. For example: the <b>User Preferences</b> dialog.

## Keying Conventions

This book uses the following keying conventions:

No prompt	When a command's format is the same for multiple platforms, the command prompt is not shown.
%	A percent sign represents the UNIX command shell prompt for a command that does not require root privileges.
#	A number sign represents the UNIX command shell prompt for a command that requires root privileges.
>	The notation > represents the MS-DOS or Windows command prompt.
...	Horizontal or vertical ellipses in format and syntax descriptions indicate that material has been eliminated to simplify a discussion.
[ ]	Brackets enclose optional items in format and syntax descriptions.
{ }	Braces enclose a list from which you must choose an item in format and syntax descriptions.
	In format and syntax descriptions, a vertical bar separates items in a list of choices enclosed in { } (braces).  In graphical user interface descriptions, a vertical bar separates menu commands (for example, select <b>File   Open</b> ).

## PREFACE

# Getting Started with Artix Security

*This chapter introduces features of Artix security by explaining the architecture and configuration of the secure HelloWorld demonstration in some detail.*

---

**In this chapter**

This chapter discusses the following topics:

<a href="#">Secure SOAP Example</a>	<a href="#">page 2</a>
<a href="#">Secure Container Example</a>	<a href="#">page 24</a>
<a href="#">Debugging with the openssl Utility</a>	<a href="#">page 31</a>

---

# Secure SOAP Example

## Overview

This section provides a brief overview of how the Artix Security Framework provides security for SOAP bindings between Artix applications. The Artix security framework is a comprehensive security framework that supports authentication and authorization using data stored in a central security service (the Artix security service). This discussion is illustrated by reference to the secure HelloWorld demonstration.

## In this section

This section contains the following subsections:

<a href="#">Secure Hello World Example</a>	<a href="#">page 3</a>
<a href="#">HTTPS Connection</a>	<a href="#">page 6</a>
<a href="#">IIOP/TLS Connection</a>	<a href="#">page 11</a>
<a href="#">Security Layer</a>	<a href="#">page 18</a>



# Secure Hello World Example

## Overview

This section provides an overview of the secure HelloWorld demonstration, which introduces several features of the Artix Security Framework. In particular, this demonstration shows you how to configure a typical Artix client and server that communicate with each other using a SOAP binding over a HTTPS transport. Figure 1 shows all the parts of the secure HelloWorld system, including the various configuration files.

**Figure 1:** Overview of the Secure HelloWorld Example

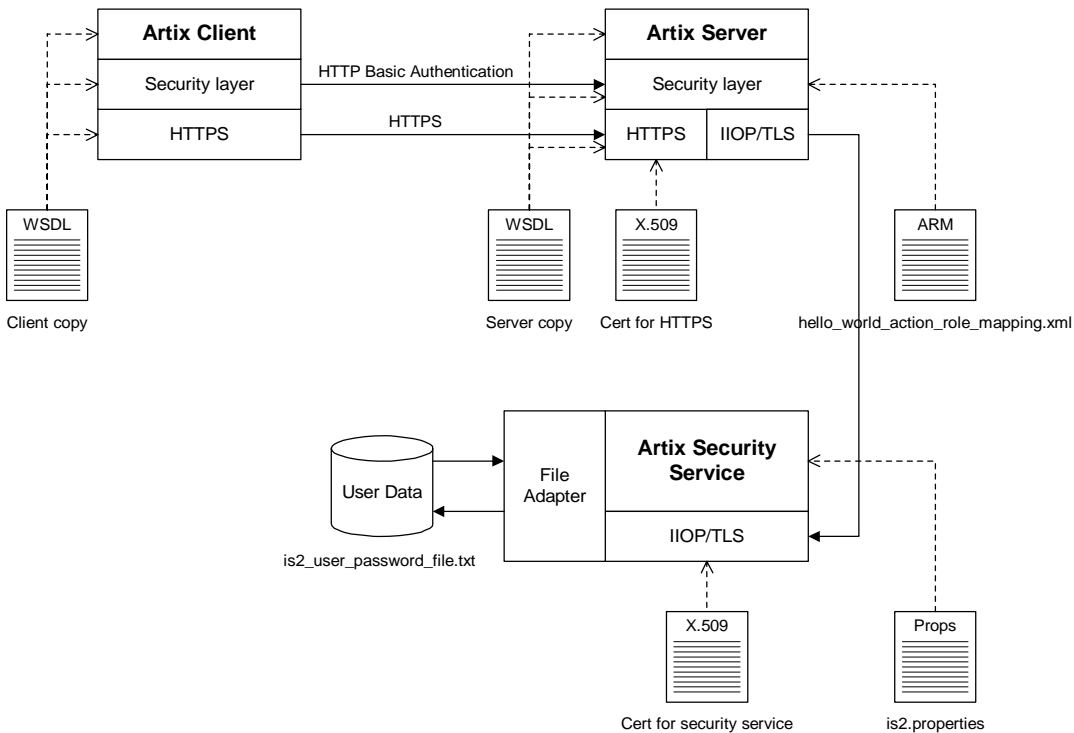

---

**Location**

The secure HelloWorld demonstration is located in the following directory:  
`ArtixInstallDir/artix/Version/demos/security/full_security`

---

**Main elements of the example**

The main elements of the secure HelloWorld example shown in [Figure 1](#) are, as follows:

- [HelloWorld client](#).
  - [HelloWorld server](#).
  - [Artix security service](#).
  - [File adapter](#).
- 

**HelloWorld client**

The HelloWorld client communicates with the HelloWorld server using SOAP over HTTPS, thus providing confidentiality for transmitted data. In addition, the HelloWorld client is configured to use HTTP BASIC authentication to transmit a username and a password to the server.

---

**HelloWorld server**

The HelloWorld server employs two different kinds of secure transport, depending on which part of the system it is talking to:

- HTTPS—to receive SOAP invocations securely from the HelloWorld client.
  - IIOP/TLS—to communicate securely with the Artix security service, which contains the central store of user data.
- 

**Artix security service**

The Artix security service manages a central repository of security-related user data. The Artix security service can be accessed remotely by Artix servers and offers the service of authenticating users and retrieving authorization data.

---

**File adapter**

The Artix security service supports a number of adapters that can be used to integrate with third-party security products (for example, an LDAP adapter is available). This example uses the *iSF file adapter*, which is a simple adapter provided for demonstration purposes.

**Note:** The file adapter is a simple adapter that does *not* scale well for large enterprise applications. IONA supports the use of the file adapter in a production environment, but the number of users is limited to 200.

---

**Security layers**

To facilitate the discussion of the HelloWorld security infrastructure, it is helpful to analyze the security features into the following layers:

- [HTTPS layer](#).
  - [IIOP/TLS layer](#).
  - [Security layer](#).
- 

**HTTPS layer**

The HTTPS layer provides a secure transport layer for SOAP bindings. In Artix, the HTTPS transport is configured by editing the Artix configuration file (for example, `artix.cfg` or `artix-secure.cfg`). Some of the HTTPS settings can optionally be set in the WSDL contract instead (both the client copy and the server copy).

For more details, see [“HTTPS Connection” on page 6](#).

---

**IIOP/TLS layer**

The IIOP/TLS layer consists of the OMG’s Internet Inter-ORB Protocol (IIOP) combined with the SSL/TLS protocol. The IIOP/TLS transport can be used either with CORBA bindings or with the Artix Tunnel plug-in. In Artix, the IIOP/TLS is configured by editing the Artix configuration file.

For more details, see [“IIOP/TLS Connection” on page 11](#).

---

**Security layer**

The security layer provides support for a simple username/password authentication mechanism, a principal authentication mechanism and support for authorization. A security administrator can edit an *action-role mapping file* to restrict user access to particular WSDL port types and operations.

For more details, see [“Security Layer” on page 18](#).

## HTTPS Connection

### Overview

Figure 2 shows an overview of the HelloWorld example, focusing on the elements relevant to the HTTPS connection. HTTPS is used on the SOAP binding between the Artix client and the Artix server.

**Figure 2:** A HTTPS Connection in the HelloWorld Example

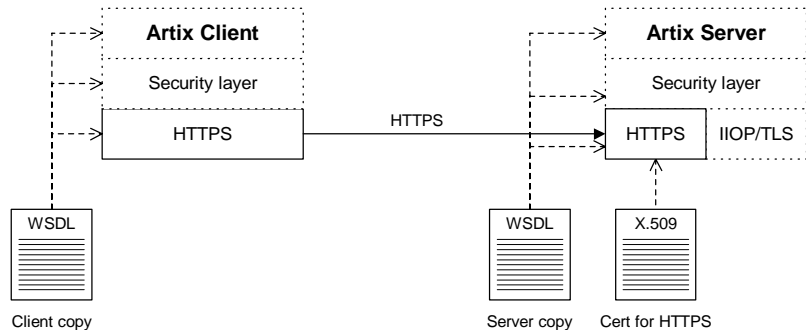

### Baltimore toolkit

HTTPS transport security is provided by the Baltimore toolkit, which is a commercial implementation of the SSL/TLS protocol.

The Baltimore toolkit supports a wide range of cipher suites—see [“Supported Cipher Suites” on page 296](#).

### Target-only authentication

The HelloWorld example is configured to use *target-only authentication* on the HTTPS connection. That is, during the TLS handshake, the server authenticates itself to the client (using an X.509 certificate), but the client does not authenticate itself to the server. Hence, there is no X.509 certificate associated with the client.

## Enabling HTTPS

To enable HTTPS, you must ensure that the URL identifying the service endpoint in the WSDL contract has the `https:` prefix. For example, the HelloWorld service specifies a SOAP over HTTPS endpoint in the `hello_world.wsdl` file as follows:

```
<wsdl:definitions name="HelloWorld"
  targetNamespace="http://www.iona.com/hello_world_soap_http"
  xmlns:soap="http://schemas.xmlsoap.org/wsdl/soap/"
  xmlns:wSDL="http://schemas.xmlsoap.org/wsdl/" ... >
  ...
  <wsdl:service name="SOAPService">
    <wsdl:port binding="tns:Greeter_SOAPBinding"
      name="SoapPort">
      <soap:address location="https://localhost:9000"/>
    </wsdl:port>
  </wsdl:service>
</wsdl:definitions>
```

## Client HTTPS configuration

[Example 1](#) shows how to configure the client side of an HTTPS connection, in the case of target-only authentication.

### Example 1: Extract from the Secure Client HTTPS Configuration

```
# Artix Configuration File
...
security {
  ...
  full_security {
    ...
    client {
1      orb_plugins = ["xmlfile_log_stream", "at_http", "https"];
2      policies:https:trusted_ca_list_policy =
        "C:\artix_30\artix\3.0\demos\security\certificates\openssl\x5
        09/ca/cacert.pem";
3
        policies:client_secure_invocation_policy:requires =
["Confidentiality", "Integrity", "DetectReplay",
"DetectMisordering", "EstablishTrustInTarget"];
        policies:client_secure_invocation_policy:supports =
["Confidentiality", "Integrity", "DetectReplay",
"DetectMisordering", "EstablishTrustInClient",
"EstablishTrustInTarget"];
    };
  };
};
```

**Example 1:** *Extract from the Secure Client HTTPS Configuration*

```
};
```

The preceding extract from `artix-security.cfg` can be explained as follows:

1. The `at_http` and `https` plug-ins together provide support for the HTTP and HTTPS protocols. You can optionally include these plug-ins in the `orb_plugins` list. If they are not explicitly listed, Artix will automatically load them when necessary.

**Note:** Loading the `https` plug-in is *not* sufficient to make a service secure. You must also configure the endpoints to have HTTPS URLs in the WSDL contract—see [“Enabling HTTPS” on page 7](#).

2. A HTTPS application needs a list of trusted CA certificates, which it uses to determine whether or not to trust certificates received from other HTTPS applications. You must, therefore, edit the `policies:https:trusted_ca_list_policy` variable to point at a list of trusted certificate authority (CA) certificates. See [“Specifying Trusted CA Certificates” on page 267](#).
3. The following two lines set the *required* options and the *supported* options for the HTTPS client secure invocation policy. In this example, the client is configured to require a secure connection and to request an X.509 certificate from the server.

**Server HTTPS configuration**

[Example 2](#) shows how to configure the server side of an HTTPS connection, in the case of target-only authentication.

**Example 2:** *Extract from the Secure Server HTTPS Configuration*

```
# Artix Configuration File
...
security {
  ...
  full_security {
    ...
    server {
      ...
    }
  }
}
```

**Example 2:** *Extract from the Secure Server HTTPS Configuration*

```

binding:client_binding_list = ["OTS+POA_Coloc",
"POA_Coloc", "OTS+GIOP+IIOP", "GIOP+IIOP", "GIOP+IIOP_TLS"];
1 orb_plugins = ["xmlfile_log_stream", "iiop_profile",
"giop", "iiop_tls", "soap", "at_http", "artix_security",
"at_http", "https"];
...
2 # Secure HTTPS settings:
policies:target_secure_invocation_policy:requires =
["Confidentiality", "Integrity", "DetectReplay",
"DetectMisordering"];
policies:target_secure_invocation_policy:supports =
["Confidentiality", "Integrity", "DetectReplay",
"DetectMisordering", "EstablishTrustInClient",
"EstablishTrustInTarget"];
3
principal_sponsor:use_principal_sponsor = "true";
principal_sponsor:auth_method_id = "pkcs12_file";
principal_sponsor:auth_method_data =
["filename=C:\artix_30\artix\3.0\demos\security\certificates\
openssl\x509\certs\testaspen.pl2", "password=testaspen"];
};
};
};

```

The preceding extract from `artix-security.cfg` can be explained as follows:

1. The `at_http` and `https` plug-ins together provide support for the HTTP and HTTPS protocols. You can optionally include these plug-ins in the `orb_plugins` list. If they are not explicitly listed, Artix will automatically load them when necessary.

**Note:** Loading the `https` plug-in is *not* sufficient to make a service secure. You must also configure the endpoints to have HTTPS URLs in the WSDL contract—see [“Enabling HTTPS” on page 7](#).

2. The following two lines set the *required* options and the *supported* options for the HTTPS target secure invocation policy. In this example, the server target is configured to require a secure connection, but it does not request a certificate from the client.

3. The `principal_sponsor` settings are used to attach a certificate to the Artix server, which identifies the server to its peers during an IIOP/TLS handshake.

**Note:** In this example, the certificate password is specified directly in the configuration file, which implies that the `artix-security.cfg` file should be readable only by the administrator. For alternative ways of specifying the certificate password, see [“Providing a Certificate Pass Phrase” on page 269](#).



## IIOPTLS Connection

### Overview

Figure 3 shows an overview of the HelloWorld example, focusing on the elements relevant to the IIOPTLS connection between the Artix server and the Artix security service. In general, the Artix security service is usually accessed through the IIOPTLS transport.

**Figure 3:** An IIOPTLS Connection in the HelloWorld Example

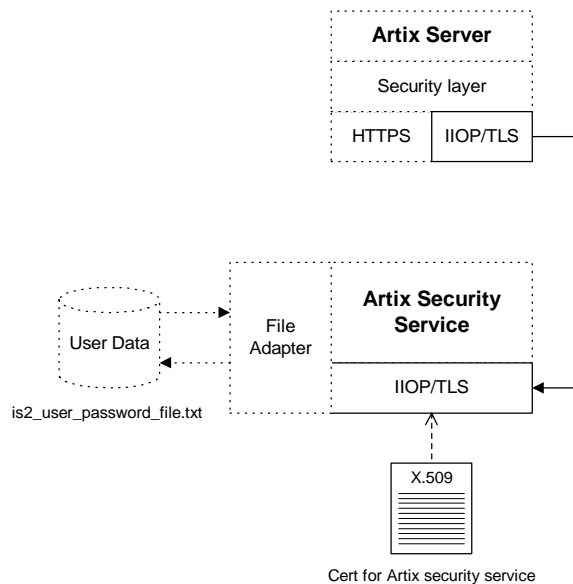

### Baltimore toolkit

IIOPTLS transport security is provided by the Baltimore toolkit, which is a commercial implementation of the SSL/TLS protocol.

The Baltimore toolkit supports a wide range of cipher suites—see [“Supported Cipher Suites” on page 296](#).

**Target-only authentication**

The HelloWorld example is configured to use *target-only authentication* on the IIOP/TLS connection between the Artix server and the Artix security service. That is, during the TLS handshake, the Artix security service authenticates itself to the Artix server (using an X.509 certificate), but the Artix server does not authenticate itself to the Artix security service. Hence, in this example there is no X.509 certificate associated with the IIOP/TLS transport in the Artix server.

**WARNING:** For a real deployment, you *must* modify the configuration of the Artix security service so that it requires *mutual* authentication. Otherwise, your system will be insecure.

**Artix server IIOP/TLS configuration**

The Artix server's IIOP/TLS transport is configured by the settings in the `ArtixInstallDir/artix/Version/etc/domains/artix-secure.cfg` file. [Example 3](#) shows an extract from the `artix-secure.cfg` file, highlighting some of the settings that are important for the HelloWorld Artix server.

**Example 3:** *Extract from the Artix Server IIOP/TLS Configuration*

```
# artix-secure.cfg File
secure_artix
{
  ...
  1 policies:trusted_ca_list_policy =
    "C:\artix\artix\1.2\demos\secure_hello_world\http_soap\certif
    icates\tls\x509\trusted_ca_lists\ca_list1.pem";
  ...
  2 initial_references:IT_SecurityService:reference =
    "corbaloc:it_iiops:1.2@localhost:55020/IT_SecurityService";
  ...
  full_security
  {
    server
    {
      3 # IIOP/TLS Settings
      orb_plugins = ["xmlfile_log_stream", "iiop_profile",
        "giop", "iiop_tls", "soap", "at_http", "artix_security",
        "https"];
      binding:client_binding_list = ["OTS+POA_Coloc",
        "POA_Coloc", "OTS+GIOP+IIOP", "GIOP+IIOP", "GIOP+IIOP_TLS"];
    }
  }
}
```

**Example 3:** *Extract from the Artix Server IIOP/TLS Configuration*

```

4     principal_sponsor:use_principal_sponsor = "true";
      principal_sponsor:auth_method_id = "pkcs12_file";
      principal_sponsor:auth_method_data =
        ["filename=C:\artix_30\artix\3.0\demos\security\certificates\
openssl\x509\certs\testaspen.p12", "password=testaspen"];

5     policies:iiop_tls:client_secure_invocation_policy:requires =
        ["Integrity", "Confidentiality", "DetectReplay",
        "DetectMisordering", "EstablishTrustInTarget"];

      policies:iiop_tls:client_secure_invocation_policy:supports =
        ["Integrity", "Confidentiality", "DetectReplay",
        "DetectMisordering", "EstablishTrustInTarget"];

6     # Security Layer Settings
      ...
    };
  };
};

```

The preceding extract from the Artix configuration file can be explained as follows:

1. The `policies:trusted_ca_list_policy` variable specifies a file containing a concatenated list of CA certificates. These CA certificates are used to check the acceptability of any certificates received by the Artix server over the IIOP/TLS transport. If a received certificate has not been digitally signed by one of the CA certificates in the list, it will be rejected by the Artix server.  
For more details, see [“Specifying Trusted CA Certificates” on page 267](#).
2. This `IT_SecurityService` initial reference gives the location of the Artix security service. When login security is enabled, the Artix server uses this information to open an IIOP/TLS connection to the Artix security service. In this example, the Artix security service is presumed to be running on `localhost` and listening on the `55020` IP port.

3. The `ORB_plugins` list specifies which of the Artix plug-ins should be loaded into the Artix server. Of particular relevance is the fact that the `iiop_tls` plug-in is included in the list (thus enabling IIOPTLS connections), whereas the `iiop` plug-in is excluded (thus disabling plain IIOPT connections).
4. The `principal_sponsor` settings are used to attach a certificate to the Artix server, which identifies the server to its peers during an IIOPT/TLS handshake.

**Note:** In this example, the certificate password is specified directly in the configuration file, which implies that the `artix-security.cfg` file should be readable only by the administrator. For alternative ways of specifying the certificate password, see [“Providing a Certificate Pass Phrase” on page 269](#).

5. The client secure invocation policies specify what sort of secure IIOPT/TLS connections the Artix server can open when it acts in a client role. In particular, these client invocation policies impose conditions on the IIOPT/TLS connection to the Artix security service.  
For more details about the client secure invocation policy, see [“Setting Association Options” on page 282](#).

**Note:** In a realistic deployment, you should add the `EstablishTrustInClient` association option to the list of supported client invocation policies. This is needed for mutual authentication.

6. Independently of the IIOPT/TLS settings, you also configure the security layer using settings in the `artix-secure.cfg` file. These settings are described in [“Security Layer” on page 18](#).

## Artix security service IIOPT/TLS configuration

[Example 4](#) shows an extract from the `artix-secure.cfg` file, highlighting the IIOPT/TLS settings that are important for the Artix security service.

**Example 4:** *Extract from the Artix security service IIOPT/TLS Configuration*

```
# artix-secure.cfg File
secure_artix
{
  ...
```

**Example 4:** *Extract from the Artix security service IIOP/TLS Configuration*

```

1  policies:trusted_ca_list_policy =
    "C:\artix\artix\1.2\demos\secure_hello_world\http_soap\certif
    icates\tls\x509\trusted_ca_lists\ca_list1.pem";
    ...
    initial_references:IT_SecurityService:reference =
    "corbaloc:it_iiops:1.2@localhost:55020/IT_SecurityService";
    ...
    full_security
    {
        ...
        security_service
        {
            # IIOP/TLS Settings
            ...
2     principal_sponsor:use_principal_sponsor = "true";
            principal_sponsor:auth_method_id = "pkcs12_file";
            principal_sponsor:auth_method_data =
            ["filename=C:\artix_30\artix\3.0\demos\security\certificates/
            tls\x509\certs/services/administrator.p12",
            "password_file=C:\artix_30\artix\3.0\demos\security\certifica
            tes\tls\x509\certs/services/administrator.pwf"];
            ...
3     policies:target_secure_invocation_policy:requires =
            ["Confidentiality", "Integrity", "DetectReplay",
            "DetectMisordering"];
            policies:target_secure_invocation_policy:supports =
            ["Confidentiality", "EstablishTrustInTarget",
            "EstablishTrustInClient", "DetectMisordering",
            "DetectReplay", "Integrity"];

4     policies:client_secure_invocation_policy:requires =
            ["Confidentiality", "Integrity", "DetectReplay",
            "DetectMisordering"];
            policies:client_secure_invocation_policy:supports =
            ["Confidentiality", "EstablishTrustInTarget",
            "EstablishTrustInClient", "DetectMisordering",
            "DetectReplay", "Integrity"];

5     orb_plugins = ["local_log_stream", "iiop_profile",
            "giop", "iiop_tls"];
            ...
6     plugins:security:iiop_tls:port = "55020";
            plugins:security:iiop_tls:host = "localhost";
            ...

```

**Example 4:** *Extract from the Artix security service IIOP/TLS Configuration*

```

7 policies:security_server:client_certificate_constraints=["%{CERT
   _CONSTRAINT_1}"];
8 policies:external_token_issuer:client_certificate_constraints=[]
   ;
   };
   ...
   };
   ...
};

```

The preceding extract from the Artix configuration file can be explained as follows:

1. The `policies:trusted_ca_list_policy` variable specifies a file containing a concatenated list of CA certificates. These CA certificates are used to check the acceptability of any certificates received by the Artix security service over the IIOP/TLS transport. If a received certificate has not been digitally signed by one of the CA certificates in the list, it will be rejected by the Artix security service.
2. The `principal_sponsor` settings are used to attach an X.509 certificate to the Artix security service. The certificate is used to identify the Artix security service to its peers during an IIOP/TLS handshake. In this example, the Artix security service's certificate is stored in a PKCS#12 file, `administrator.p12`, and the certificate's private key password is stored in another file, `administrator.pwf`.  
For more details about configuring the IIOP/TLS principal sponsor, see [“principal\\_sponsor” on page 476](#) and [“Providing a Certificate Pass Phrase” on page 269](#).
3. The target secure invocation policies specify what sort of secure IIOP/TLS connections the Artix security service can accept when it acts in a server role. For more details about the target secure invocation policy, see [“Setting Association Options” on page 282](#).

**WARNING:** The target secure invocation policies shown here are too weak for a realistic deployment of the Artix security service. In particular, you should also require `EstablishTrustInClient`. For example, see [“Mutual Authentication” on page 264](#).

4. The client secure invocation policies specify what sort of secure IIOp/TLS connections the Artix security service can open when it acts in a client role.
5. The ORB `plugins` list specifies which plug-ins should be loaded into the Artix security service. Of particular relevance is the fact that the `iiop_tls` plug-in is included in the list (thus enabling IIOp/TLS connections), whereas the `iiop` plug-in is excluded (thus disabling plain IIOp connections).
6. If you want to relocate the Artix security service, you must modify the `plugins:security:iiop_tls:host` and `plugins:security:iiop_tls:port` settings to specify, respectively, the host where the server is running and the IP port on which the server listens for secure IIOp/TLS connections.
7. An application can open a connection to the Artix security service only if it presents an X.509 certificate that satisfies the certificate constraints specified by this setting.  
For details of how to specify certificate constraints, see [“Applying Constraints to Certificates” on page 401](#).
8. Disable the external token issuer feature by setting the token issuer certificate constraints to be an empty list (as shown here). This feature would only be enabled in the context of an integration with Artix mainframe.

# Security Layer

## Overview

Figure 4 shows an overview of the HelloWorld example, focusing on the elements relevant to the security layer. The security layer, in general, takes care of those aspects of security that arise *after* the initial SSL/TLS handshake has occurred and the secure connection has been set up.

**Figure 4:** *The Security Layer in the HelloWorld Example*

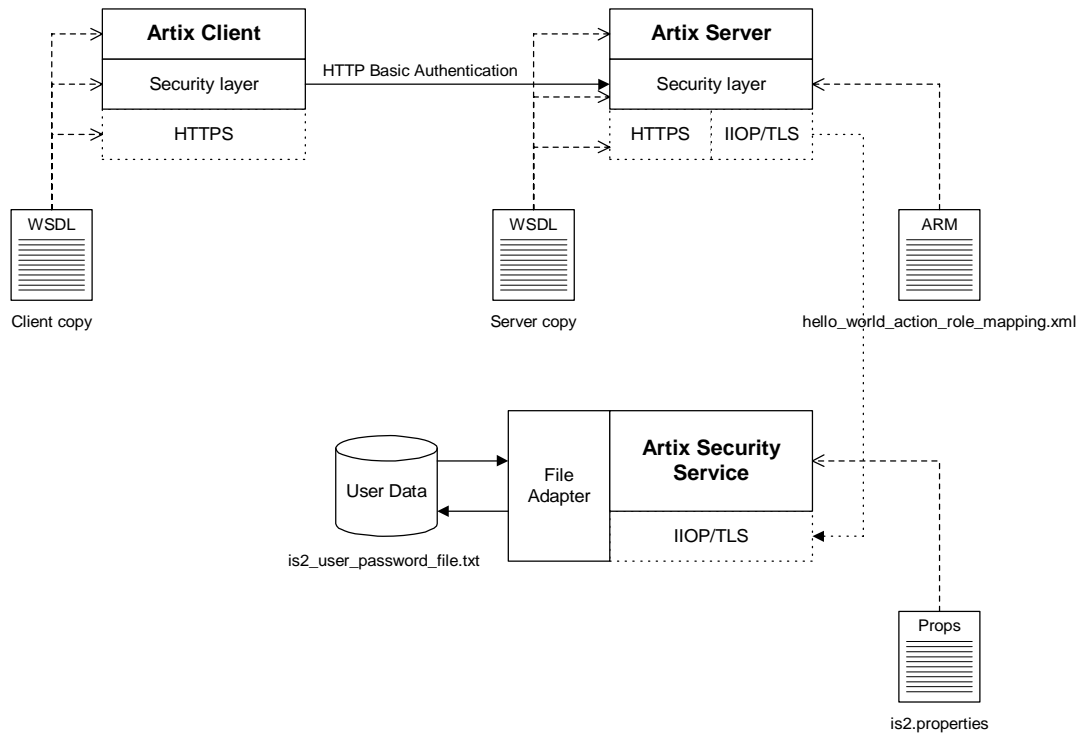



The security layer normally uses a simple username/password combination for authentication, because clients usually do not have a certificate with which to identify themselves. The username and password are sent along with every operation, enabling the Artix server to check every invocation and make fine-grained access decisions.

## HTTP BASIC login

The mechanism that the Artix client uses to transmit a username and password over a SOAP binding is *HTTP BASIC login*. This is a standard login mechanism commonly used by Web browsers and Web services. On its own, HTTP BASIC login would be relatively insecure, because the username and password would be transmitted in plaintext. When combined with the HTTPS protocol, however, the username and password are transmitted securely over an encrypted connection, thus preventing eavesdropping.

The following extract from the client copy of the WSDL contract shows how the `UserName` and `Password` attributes in the `<http-conf:client>` tag set the HTTP BASIC login parameters for the Artix SOAP client.

```
<definitions name="HelloWorld"
  targetNamespace="http://www.iona.com/full_security"
  xmlns="http://schemas.xmlsoap.org/wsdl/"
  xmlns:http-conf="http://schemas.iona.com/transport/http/configuration"
  xmlns:soap="http://schemas.xmlsoap.org/wsdl/soap/"
  xmlns:bus-security="http://schemas.iona.com/bus/security"
  ... >
  <service name="SOAPService">
    <port binding="tns:Greeter_SOAPBinding" name="SoapPort">
      <soap:address location="https://localhost:9000"/>
      <http-conf:client
        ...
        Username="user_test"
        Password="user_password"
      />
      <bus-security:security enableSecurity="true"/>
    </port>
  </service>
</definitions>
```

Setting `enableSecurity` to `true` in the `bus-security:security` element ensures that the Artix security plug-in is loaded and enabled. Alternatively, you could enable the security plug-in in the Artix configuration file. See [“Configuring the Artix Security Plug-In” on page 137](#) for details.

## Authentication through the iSF file adapter

On the server side, the Artix server delegates authentication to the Artix security service, which acts as a central repository for user data. The Artix security service is configured by the `is2.properties` file, whose location is specified in the `artix-secure.cfg` file as follows:

```
# artix-secure.cfg File
secure_artix {
  ...
  full_security {
    ...
    security_service {
      plugins:java_server:system_properties =
["org.omg.CORBA.ORBClass=com.iona.corba.art.artimpl.ORBImpl",
"org.omg.CORBA.ORBSingletonClass=com.iona.corba.art.artimpl.ORBSingleton",
"is2.properties=C:\artix_30\artix\3.0\demos\security\full_security\cxx\security_service\is2.properties.FILE",
"java.endorsed.dirs=C:\artix_30\artix\3.0\lib\endorsed"];
      ...
    };
    ...
  };
  ...
};
```

In this example, the `is2.properties` file specifies that the Artix security service should use a file adapter. The file adapter is configured as follows:

```
# is2.properties File
...
#####
##
## File Adapter Properties
##
#####
com.iona.isp.adapter.file.class=com.iona.security.is2adapter.file.FileAuthAdapter
com.iona.isp.adapter.file.params=filename
com.iona.isp.adapter.file.param.filename=../../etc/is2_user_password_file.txt
```

The `com.iona.isp.adapter.file.param.filename` property is used to specify the location of a file, `is2_user_password_file.txt`, which contains the user data for the iSF file adapter. [Example 5](#) shows the contents of the user data file for the secure HelloWorld demonstration.

**Example 5:** *User Data from the `is2_user_password_file.txt` File*

```
<?xml version="1.0" encoding="utf-8" ?>

<ns:securityInfo xmlns:ns="urn:www-xmlbus-com:simple-security">
  <users>
    <users>
      <user name="user_test" password="user_password">
        <realm name="IONAGlobalRealm">
          <role name="IONAUserRole"/>
          <role name="PaulOnlyRole"/>
        </realm>
      </user>
    </users>
  </ns:securityInfo>
```

In order for the login step to succeed, an Artix client must supply one of the usernames and passwords that appear in this file. The realm and role data, which also appear, are used for authorization and access control.

For more details about the iSF file adapter, see [“Managing a File Security Domain” on page 210](#).

**Note:** The file adapter is a simple adapter that does *not* scale well for large enterprise applications. IONA supports the use of the file adapter in a production environment, but the number of users is limited to 200.

## Server domain configuration and access control

On the server side, authentication and authorization must be enabled by the appropriate settings in the `artix-secure.cfg` file. [Example 6](#) explains the security layer settings that appear in the `artix-secure.cfg` file.

**Example 6:** *Security Layer Settings from the `artix-secure.cfg` File*

```
# artix-secure.cfg File
secure_artix
{
  ...
  full_security
  {
```

**Example 6:** Security Layer Settings from the `artix-secure.cfg` File

```

server
{
    # IIOP/TLS Settings
    ...

    # Security Layer Settings
    plugins:artix_security:shlib_name="it_security_plugin";
1   binding:artix:server_request_interceptor_list=
   "security";
2   orb_plugins = ["xmlfile_log_stream", "iiop_profile",
   "giop", "iiop_tls", "soap", "at_http", "artix_security",
   "https"];

3   policies:asp:enable_authorization = "true";
4   plugins:is2_authorization:action_role_mapping =
   "file://C:\artix\artix\1.2\demos\secure_hello_world\http_soap
   /config/helloworld_action_role_mapping.xml";
5   plugins:asp:authorization_realm = "IONAGlobalRealm";
6   plugins:asp:security_level = "MESSAGE_LEVEL";
   plugins:asp:authentication_cache_size = "5";
   plugins:asp:authentication_cache_timeout = "10";
};
};
};

```

The security layer settings from the `artix-secure.cfg` file can be explained as follows:

1. The Artix server request interceptor list must include the `security` interceptor, which provides part of the functionality for the Artix security layer.
2. The server's `orb_plugins` list must include the `artix_security` plug-in.
3. The `policies:asp:enable_authorization` variable is set to `true` to enable authorization.
4. This setting specifies the location of an *action-role mapping file* that provides fine-grained access control to operations and port types.
5. The Artix authorization realm determines which of the user's roles will be considered during an access control decision. Artix authorization realms provide a way of grouping user roles together. The `IONAGlobalRealm` (the default) includes all user roles.

6. The `plugins:asp:security_level` variable specifies which client credentials are used for the purposes of authentication and authorization on the server side (in this case, the `MESSAGE_LEVEL` value indicates that the username/password credentials sent in the HTTP header).

[Example 7](#) shows the contents of the action-role mapping file for the HelloWorld demonstration.

**Example 7:** *Action-Role Mapping file for the HelloWorld Demonstration*

```
<?xml version="1.0" encoding="UTF-8"?>
<!DOCTYPE secure-system SYSTEM "actionrolemapping.dtd">
<secure-system>
  <action-role-mapping>

    <server-name>secure_artix.full_security.server</server-name>

    <interface>
      <name>http://www.iona.com/full_security:Greeter</name>
      <action-role>
        <action-name>sayHi</action-name>
        <role-name>IONAUserRole</role-name>
      </action-role>
      <action-role>
        <action-name>greetMe</action-name>
        <role-name>IONAUserRole</role-name>
      </action-role>
    </interface>

  </action-role-mapping>
</secure-system>
```

For a detailed discussion of how to define access control using action-role mapping files, see [“Managing Users, Roles and Domains” on page 201](#).

# Secure Container Example

## Location of demonstration

The secure container demonstration is located in the following directory:

```
ArtixInstallDir/artix/Version/demos/advanced/container/secure_container
```

## Scenario description

The secure container demonstration illustrates a scenario where some components are configured to be secure while others are insecure. The various components are configured as follows:

- *WSDL publishing service*—provides the main point of contact with the container (runs on the port specified by the container's `-port` option). This endpoint is insecure.
- *Container service*—provides administrative operations, which can be accessed using the `it_container_admin` utility. This endpoint is secured through HTTPS and the Artix security layer.
- *Other Artix services*—can be either secure or insecure, depending on the settings in the WSDL contract.

## Connecting to the container service

Figure 5 shows an overview of how the `it_container_admin` client establishes a secure connection to the `ContainerService` service.

**Figure 5:** Connecting to a Secure Container Service

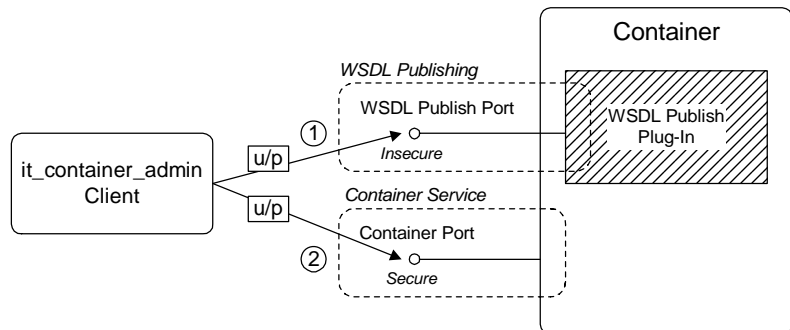

The connection from the `it_container_admin` client to the `ContainerService` service is established in two steps, as follows:

1. The `it_container_admin` client sends a message to the port supplied to the `-port` option, requesting the WSDL publishing service to send the WSDL contract for the `ContainerService` service.

**Note:** This initial connection is *insecure*, because the WSDL publishing service is configured to be insecure in this demonstration. The username and password sent by the `it_container_admin` client are therefore potentially vulnerable to eavesdropping in this scenario.

2. Using the endpoint details from the retrieved WSDL contract, the `it_container_admin` client establishes a secure connection to the `ContainerService` endpoint. With every operation invocation on the `ContainerService` service, the `it_container_admin` client sends WSSE username and password credentials, `u/p`, to authenticate itself to the container.

---

## Configuring the secure container

In this scenario, the container service is configured to have the following security characteristics:

- The container service accepts only HTTPS connections.
- Clients of the container service can present X.509 certificates, but are not required to do so.
- Clients must present WSSE username and password credentials.
- The received WSSE username and password credentials are sent to the Artix security service to be authenticated.
- Depending on which configuration is used to run the container service, the Artix security plug-in might also limit what clients can do by applying role-based access control.

For most of the preceding security features, the container service is configured in a similar way to any other Artix server (for example, see the details of secure Artix server configuration in [“Secure SOAP Example” on page 2](#)).

The following configuration setting, however, is specific to the secure container service:

```
plugins:at_http:server:use_secure_sockets:container = "true";
```

This boolean variable enables the HTTPS protocol for the container service alone. Because the effect of this variable is restricted to the container service, it is possible also to deploy other insecure services into the container.

When `plugins:at_http:server:use_secure_sockets:container` is `true`, HTTPS is enabled for the container service only (subject to the effective target secure invocation policy); when `false`, HTTPS is not specifically enabled (although other configuration settings might enable it). The default is `false`.

**Note:** This behavior contrasts with the behavior of the `plugins:at_http:server:use_secure_sockets` variable, which enables HTTPS for *all* services in the container (including the `ContainerService` service itself).

## Configuring the secure it\_container\_admin utility

In order to administer a secure container with the `it_container_admin` utility, it is necessary to define a custom configuration scope. The configuration scope enables the `it_container_admin` utility to invoke remote administration commands securely.

### Example 8: Configuration for Connecting to Secure Container

```
# Artix Configuration File
secure_artix
{
  secure_container
  {
    client_authentication
    {
1      orb_plugins = ["xmlfile_log_stream", "https"];
2      policies:https:trusted_ca_list_policy =
"%{ROOT_TRUSTED_CA_LIST_POLICY_1}";
3
4      bus:security:enable_security = "true";
      principal_sponsor:use_principal_sponsor = "true";
      principal_sponsor:auth_method_id = "pkcs12_file";
      principal_sponsor:auth_method_data =
["filename=%{PRIVATE_CERT_1}",
"password_file=%{PRIVATE_CERT_PASSWORD_FILE_1}"];
    };
  };
};
```



**Example 8:** *Configuration for Connecting to Secure Container*

```
};
```

The preceding configuration can be explained as follows:

1. This line loads the `https` plug-in at start-up time. This is not strictly necessary, however, because Artix can load the `https` plug-in dynamically whenever it is needed.

**Note:** In particular, loading the `https` plug-in does not automatically enable HTTPS security. The `it_container_admin` client dynamically enables security for any service whose address URL starts with the `https:` prefix.

2. The client side of a HTTPS connection must always provide a list of trusted CA certificates. During the SSL/TLS handshake, the client checks that the server certificate has been signed by a trusted CA.
3. The `bus:security:enable_security` variable is set to `true`, to enable authentication using WSSE username and password on the client side. In this case, because the username and password are not explicitly provided in configuration, the `it_container_admin` utility will prompt the user to enter the username and password from the command line in a secure mode (where keystrokes cannot be intercepted).
4. The `principal_sponsor` settings associate an X.509 certificate with the `it_container_admin` client. You only need to include these settings, if the container is configured to require client authentication.

To run the `it_container_admin` utility with the preceding configuration, enter a command of the following form:

```
it_container_admin -ORBname
    secure_artix.secure_container.client_authentication_config
    -port Port CommandOption
```

Where the `Port` option specifies the IP port where the container is listening for connections and the `CommandOption` specifies one of the container administration commands (see *Configuring and Deploying Artix Solutions* for details of `it_container_admin` commands).

When you run the `it_container_admin` command, you will be prompted as follows for the WSSE username and password:

```
Please enter login : WSSE_Username
Please enter password :
```

Instead of providing the WSSE username and password at the command line, you can provide them directly in the configuration file using the following settings:

```
bus:security:user_name = "WSSE_Username";
bus:security:user_password = "WSSE_Password";
```

## Configuring deployed Artix services

Because the services in the container (including the `ContainerService` itself) all share the same Artix configuration, you must edit the endpoint settings in the WSDL contract, in order to tailor the security settings for individual services.

For example, for a SOAP over HTTP service, there are two main aspects of security that can be enabled:

- *HTTPS security*—requires incoming connections to use SSL/TLS.
- *Artix security layer*—enables authentication of credentials through the Artix security service. Optionally, this might also involve authorization using role-based access control.

You can selectively enable or disable these two security features by editing the service's WSDL contract as follows:

### Enable HTTPS security and Artix security layer

To enable both HTTPS security and the Artix security layer for the `WellWisherService` service in the secure container demonstration, use the following endpoint configuration:

```
<definitions ... >
...
<service name="WellWisherService">
  <port binding="tns:WellWisher_SOAPBinding"
        name="WellWisherPort">
    <soap:address
      location="https://localhost:9999/wellwisher"/>
    </port>
  </service>
</definitions>
```

Where the HTTPS protocol is enabled by putting the `https:` prefix in the SOAP URL and the Artix security layer is implicitly enabled (because the container configuration already enables Artix security).

### Enable HTTPS security only

To enable HTTPS only for the `WellWisherService` service, use the following endpoint configuration:

```
<definitions ... >
...
<service name="WellWisherService">
  <port binding="tns:WellWisher_SOAPBinding"
        name="WellWisherPort">
    <soap:address
      location="https://localhost:9999/wellwisher"/>
    <bus-security:security enableSecurity="false"/>
    </port>
  </service>
</definitions>
```

Where the Artix security layer is explicitly disabled (for this endpoint only) by setting the `enableSecurity` attribute to `false` in the `bus-security:security` element.

**Insecure service**

To disable security completely for the `wellWisherService` service, use the following endpoint configuration:

```
<definitions ... >
...
<service name="WellWisherService">
  <port binding="tns:WellWisher_SOAPBinding"
        name="WellWisherPort">
    <soap:address
      location="http://localhost:9999/wellwisher"/>
    <bus-security:security enableSecurity="false"/>
  </port>
</service>
</definitions>
```

Where the insecure HTTP protocol is selected by putting the `http:` prefix in the SOAP URL and the Artix security layer is explicitly disabled for this endpoint. You must also ensure that `plugins:at_http:use_secure_sockets` is not set to `true` in the Artix configuration (this setting would force the port to use the HTTPS protocol).

**Securing the WSDL publishing service**

It is possible to make the container completely secure by securing the WSDL publishing service (in addition to securing the container service).

Details of how to deploy the WSDL publishing service securely in a container are given in [“Deploying WSDL Publish in a Container” on page 127](#).

**Note:** Artix 4.0 has a limitation, which forces you to make *all* of the services in a container secure, if you make the WSDL publishing service secure.

---

# Debugging with the openssl Utility

---

## Overview

The OpenSSL toolkit is an open source implementation of SSL and TLS. OpenSSL provides a utility, `openssl`, which includes two powerful tools for debugging SSL/TLS client and server applications, as follows:

- `openssl s_client`—an SSL/TLS test client, which can be used to test secure Artix servers. The test client can connect to a secure port, while providing a detailed log of the steps performed during the SSL/TLS handshake.
- `openssl s_server`—an SSL/TLS test server, which can be used to test secure Artix clients. The test server can simulate a bare bones SSL/TLS server (handshake only). Additionally, by supplying the `-www` switch, the test server can also simulate a simple secure Web server.

---

## Downloading OpenSSL

The Artix product does *not* include the `openssl` utility, but you can download and install it yourself from the following Web site:

- <http://www.openss.org>

---

## References

For complete details of the `openssl s_client` and the `openssl s_server` commands, see the following OpenSSL documentation pages:

- [http://www.openssl.org/docs/apps/s\\_client.html](http://www.openssl.org/docs/apps/s_client.html)
- [http://www.openssl.org/docs/apps/s\\_server.html](http://www.openssl.org/docs/apps/s_server.html)

---

## Debugging example

Consider the HelloWorld demonstration discussed in the previous section, [Secure SOAP Example page 2](#). This demonstration consists of a client and a target server.

To demonstrate SSL debugging, you can use the `openssl` test client to connect directly to the target server.

**Debugging steps**

The following table shows the steps required to debug a secure server by connecting to that server using the `openssl` test client:

Step	Action
1	<a href="#">Convert the client certificate to PEM format.</a>
2	<a href="#">Run the target server.</a>
3	<a href="#">Obtain the target server's IP port.</a>
4	<a href="#">Run the test client.</a>

**Convert the client certificate to PEM format**

Certificates for Artix applications are deployed in PKCS#12 format, whereas the `openssl` test client requires the certificate to be in PEM format (a format that is proprietary to OpenSSL). It is, therefore, necessary to convert the client certificate to the PEM format.

For example, given the certificate `testaspen.p12` (located in the `ArtixInstallDir/artix/Version/demos/security/certificates/openssl/x509/certs` directory), you can convert the certificate to PEM format as follows.

1. Run the `openssl pkcs12` command, as follows:

```
openssl pkcs12 -in testaspen.p12 -out testaspen.pem
```

When you run this command you are prompted to enter, first of all, the pass phrase for the `testaspen.p12` file and then to enter a pass phrase for the newly created `testaspen.pem` file.

2. The `testaspen.pem` file generated in the previous step contains a CA certificate, an application certificate, and the application certificate's private key. Before you can use the `testaspen.pem` file with the `openssl` test client, however, you must remove the CA certificate from the file. That is, the file should contain only the application certificate and its private key.

For example, after deleting the CA certificate from the `testaspen.pem` file, the contents of the file should look something like the following:

```
Bag Attributes
```

```

localKeyID: 6A F2 11 9B A4 69 16 3C 3B 08 32 87 A6 7D 7C 91
C1 E1 FF 4A
friendlyName: Administrator
subject=/C=US/ST=Massachusetts/O=ABigBank -- no warranty -- demo
purposes/OU=Administration/CN=Administrator/emailAddress=admin
istrator@abigbank.com
issuer=/C=US/ST=Massachusetts/L=Boston/O=ABigBank -- no warranty
-- demo purposes/OU=Demonstration Section -- no warranty
--/CN=ABigBank Certificate
Authority/emailAddress=info@abigbank.com
-----BEGIN CERTIFICATE-----
MIIEiITCCA/KgAwIBAgIBATANBgkqhkiG9w0BAQQFADCB5jELMAkGA1UEBhMCMVmx
FjAUBgNVBAGITDU1hc3NhY2h1c2V0dHMxDzANBgNVBACTBkKjc3RvbWJEMC8GA1UE
ChMoQUUpZ0JhbmsgLS0gYm8gd2FycmFudHkgLS0gZGVtbyBwdXJwb3N1czEwMC4G
A1UECXMnRGVtb25zdHJhdGlvbiBTZWNoaW9uIC0tIG5vIHdhenJhbnR5IC0tMScw
JQYDVQQDEEx5BQmlnQmFuayBDZXJ0aWZpY2F0ZSBBdXRob3JpdHkxIDAeBgkqhkiG
9w0BCQEWEW1uZm9AYWJpZ2JhbmsuY29tMB4XDTA0MTEExODEwNzE0MDgW
NzEwNTE1NVowgbQxCzAJBgNVBAYTA1VTMRYwFAYDVQQIEw1NYXNzYWNodXNldHRz
MTEwLWYyDVQQKEyhbQmlnQmFuayAtLSBubyB3YXJyYW50eSAtLSBkZW1vIHBlcnBv
c2VzMRCwFQYDVQQLEx5BZG1pbmlzZDhJhdGlvbWJEMWBgGA1UEAxMNQWRtaW5pc3Ry
YXRvcjEpmCcGCSqGSIb3DQEJARYaYWRtaW5pc3RyYXRvcjEpmYmlnYmFuay5jb20w
gZ8wDQYJKoZIhvcNAQEBBQADgY0AMIGJAoGBANK7503YBkkjCvgy0pOPxAU+M6Rt
0QzaQ8/YlciWlQ/oCT/17+3P/ZhHAJaT+QxmahQHdY5ePixGyaE7raut2MdjHOuo
wCKtZqlhuNa8juJSvsN5iTUupzp/mRQ/j4rOxr8gWI5dh5d/kF4+H5s8yrxNjrDg
tY7fdxP9Kt0x9sYPAGMBAAGjggF1MIIBCcTAJBgNVHRMEAjaAMCwCGWCSAGG+EIB
DQQFh1PcGVuU1NMIEdlbmVYXRlZCBkZXJ0aWZpY2F0ZTAuBGNVHQ4EFgQUJbdk
9LPZPsaE9+a/FWbCz2LQxWkwwgEVBgNVHSMGggEMMIIBCIAUJz9oNb6Yq8d1nbH
BPjtS7uI0WyhgeykgekweYxCzAJBgNVBAYTA1VTMRYwFAYDVQQIEw1NYXNzYWN0
dXNldHRzMQ8wDQYDVQQHEWZCb3N0b24xMTAvBgNVBAoTKEFCaWdCYW5rIC0tIG5v
IHdhenJhbnR5IC0tIGRlbW8gcHVycG9zZXNlZDhJhdGlvbWJEMWBgNVBAAsTj0RlbW9uc3RyYXRp
b24gU2VjdGlvbiAtLSBubyB3YXJyYW50eSAtLlTenMCUGA1UEAxMeQUUpZ0Jhbmsg
Q2VydG1maWNhdGUgQXV0aG9yaXR5MSAwHgYJKoZIhvcNAQkBFhFpbmZvQGFiawdi
YW5rLmNvbYIBADANBgkqhkiG9w0BAQQFAA0BgQC7S5RiDsK3ZChIVpHPQrpQj5BA
J5DYTAmgzac7pkxy8rQzYvG5FjHL7beuzT3jdm2fvQJ8M7t8EMkHKPqeguArnY+x
3VNGwv1kr5jQTDeOd7d9Ilo2fknQA14j/wPFEDUwdz4n9TThjE7l1pj6zG27EivF
cm/h2L/DpWgZK0T9Q==
-----END CERTIFICATE-----
Bag Attributes
localKeyID: 6A F2 11 9B A4 69 16 3C 3B 08 32 87 A6 7D 7C 91
C1 E1 FF 4A
friendlyName: Administrator
Key Attributes: <No Attributes>
-----BEGIN RSA PRIVATE KEY-----
Proc-Type: 4, ENCRYPTED
DEK-Info: DES-EDE3-CBC,AD8F864A0E97FB4E

e3cexhY+kAujb6cOs9skerP2qZsaur33yyp4cdZiAkAi1cmfA/mLv2pfgao8gfu9

```

```

yroNvYyDADEZzagEyzF/4FGUlnScZjAiy9Imi9mA/1SHD5g1HH/wl2bgXc1BqtC3
GrfiHzGmbWyzDUj0PHjw/EkbyxQBjsCe4fPuCGVH7frcCpeE1q2EqRKBHCa3vkHr
6hrwuWS18TXn8DtCCFFtugouHXwKeGjJxE5PYfKak18BOWKgiZqtj1DHY6G2oERL
ZgNtAB+XF9vrA5XZHNSU6RBeXmVsrU1OGzdVrCnojD6d8Be7Q7KBSHDV9XzZ1PKp
7DYVn5DyFSEQ7kYs9dsaZ5Id5iNkMJiscPp7AL2SJAwpYlUfEN5gFnIYiwXP1ckF
STTiQ+BG8UPPm6G3KGgRZMZ0Ih7DySZufbe24N1rN74kXV9Vf/RpxzNiMz/PbLdG
6wiyp47We/4OqxLv8YIjGGEdYyaB/Y7XEyE9ZL74Dc3CcuSvtA2fC8hU3cXjKbu7
YsVz/Dq8G0w223owpZ0Qz2KUL9CLq/hmYLOJt1yLVoaGZuJ1CWXdgX0dComDOR8K
aIaUagy/Gz2zys20N5WRK+s+HzqoB0vneOy4Z1Ss71HfGAUemiRTAI8DXizgyHYK
5m6iSSB961xOM7YI58JYOGNLMXzLmCUAyCQhklWGFEN4cZBrkh5o6r+U4FcwhF
dvDoBu39Xie5gHFrJU86qhzxi202h0s02vexvujSGyNy009PJGkEAhJGF0G+a2Qq
VBwuUZqo0zIJ6gUrMV1LOAWwL7zFxyKaF51ijF1C9KxtEKm0393zag==
-----END RSA PRIVATE KEY-----

```

### Run the target server

Run the target server, as described in the `README.txt` file in the `demoss/security/full_security` directory.

### Obtain the target server's IP port

In this demonstration, the server's IP port is specified explicitly in the WSDL contract, `demoss/security/full_security/etc/hello_world.wsdl`. For example, in this contract the `SOAPService` service is configured as follows:

```

<wsdl:definitions name="HelloWorld"
  targetNamespace="http://www.iona.com/full_security"
  ...
>
  ...
  <wsdl:service name="SOAPService">
    <wsdl:port binding="tns:Greeter_SOAPBinding"
      name="SoapPort">
      <soap:address location="https://localhost:9000"/>
    </wsdl:port>
  </wsdl:service>
</wsdl:definitions>

```

In this example, the target server's IP port is 9000.

### Run the test client

To run the `openssl` test client, open a command prompt, change directory to the directory containing the `testaspen.pem` file, and enter the following command:

```

openssl s_client -connect localhost:9000 -ssl3 -cert
testaspen.pem

```



When you enter the command, you are prompted to enter the pass phrase for the `testaspen.pem` file.

The `openssl s_client` command switches can be explained as follows:

`-connect host:port`

Open a secure connection to the specified *host* and *port*.

`-ssl3`

This option configures the client to initiate the handshake using SSL v3 (the default is SSL v2). To see which SSL version (or versions) the target server is configured to use, check the value of the `policies:mechanism_policy:protocol_version` variable in the Artix configuration file. Artix servers can also be configured to use TLS v1, for which the corresponding `openssl` command switch is `-tls1`.

`-cert testaspen.pem`

Specifies `testaspen.pem` as the test client's own certificate. The PEM file should contain only the application certificate and the application certificate's private key. The PEM file should *not* contain a complete certificate chain.

If your server is not configured to require a client certificate, you can omit the `-cert` switch.

#### Other command switches

The `openssl s_client` command supports numerous other command switches, details of which can be found on the OpenSSL document pages. Two of the more interesting switches are `-state` and `-debug`, which log extra details to the command console during the handshake.



# Introduction to the Artix Security Framework

*This chapter describes the overall architecture of the Artix Security Framework.*

## **In this chapter**

---

This chapter discusses the following topics:

<a href="#">Artix Security Architecture</a>	<a href="#">page 38</a>
<a href="#">Caching of Credentials</a>	<a href="#">page 45</a>

---

# Artix Security Architecture

---

## Overview

The Artix security architecture embraces a variety of protocols and security technologies. This section provides a brief overview of the security features supported by the different kinds of Artix bindings.

---

## In this section

This section contains the following subsections:

<a href="#">Types of Security Credential</a>	<a href="#">page 39</a>
<a href="#">Protocol Layers</a>	<a href="#">page 41</a>
<a href="#">Security Layer</a>	<a href="#">page 43</a>
<a href="#">Using Multiple Bindings</a>	<a href="#">page 44</a>

---

## Types of Security Credential

---

### Overview

The following types of security credentials are supported by the Artix security framework:

- [WSSE username token](#).
  - [WSSE Kerberos token](#).
  - [CORBA Principal](#).
  - [HTTP Basic Authentication](#).
  - [X.509 certificate](#).
  - [CSI authorization over transport](#).
  - [CSI identity assertion](#).
  - [SSO token](#).
- 

### WSSE username token

The Web service security extension (WSSE) UsernameToken is a username/password combination that can be sent in a SOAP header. The specification of WSSE UsernameToken is contained in the [WSS UsernameToken Profile 1.0](#) document from [OASIS](#) ([www.oasis-open.org](http://www.oasis-open.org)). This type of credential is available for the SOAP binding in combination with any kind of Artix transport.

---

### WSSE Kerberos token

The WSSE Kerberos specification is used to send a Kerberos security token in a SOAP header. The implementation is based on the Kerberos Token Profile v1.0 specification ([wss-kerberos-token-profile-1.0](#)). If you use Kerberos, you must also configure the Artix security service to use the Kerberos adapter. This type of credential is available for the SOAP binding in combination with any kind of Artix transport.

---

### CORBA Principal

The CORBA Principal is a legacy feature originally defined in the early versions of the CORBA GIOP specification. The CORBA Principal is effectively just a username (no password can be propagated). This type of credential is available only for the CORBA binding and for SOAP over HTTP.

---

**HTTP Basic Authentication**

HTTP Basic Authentication is used to propagate username/password credentials in a HTTP header.

This type of credential is available to any HTTP-compatible binding.

---

**X.509 certificate**

Two different kinds of X.509 certificate-based authentication are provided, depending on the type of Artix binding, as follows:

- *HTTP-compatible binding*—in this case, the common name (CN) is extracted from the X.509 certificate's subject DN. A combination of the common name and a default password is then sent to the Artix security service to be authenticated.
- *CORBA binding*—in this case, authentication is based on the entire X.509 certificate, which is sent to the Artix security service to be authenticated.

This type of credential is available to any transport that uses SSL/TLS.

---

**CSI authorization over transport**

The OMG's Common Secure Interoperability (CSI) specification defines an *authorization over transport* mechanism, which passes username/password data inside a GIOP service context. This kind of authentication is available only for the CORBA binding.

This type of credential is available only for the CORBA binding.

---

**CSI identity assertion**

The OMG's Common Secure Interoperability (CSI) specification also defines an *identity assertion* mechanism, which passes username data (no password) inside a GIOP service context. The basic idea behind CSI identity assertion is that the request message comes from a secure peer that can be trusted to assert the identity of a user. This kind of authentication is available only for the CORBA binding.

This type of credential is available only for the CORBA binding.

---

**SSO token**

An SSO token is propagated in the context of a system that uses *single sign-on*. For details of the Artix single sign-on feature, see [“Single Sign-On” on page 109](#).

---

# Protocol Layers

---

## Overview

Within the Artix security architecture, each binding type consists of a stack of protocol layers, where a protocol layer is typically implemented as a distinct Artix plug-in. This subsection describes the protocol layers for the following binding types:

- [HTTP-compatible binding](#).
- [SOAP binding](#).
- [CORBA binding](#).

---

## HTTP-compatible binding

*HTTP-compatible* means any Artix binding that can be layered on top of the HTTP protocol. [Figure 6](#) shows the protocol layers and the kinds of authentication available to a HTTP-compatible binding.

**Figure 6:** *Protocol Layers in a HTTP-Compatible Binding*

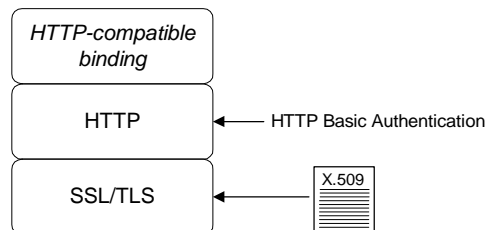

**SOAP binding**

The SOAP binding is a specific example of a HTTP-compatible binding. The SOAP binding is special, because it defines several additional credentials that can be propagated only in a SOAP header. [Figure 7](#) shows the protocol layers and the kinds of authentication available to the SOAP binding over HTTP.

**Figure 7:** *Protocol Layers in a SOAP Binding*

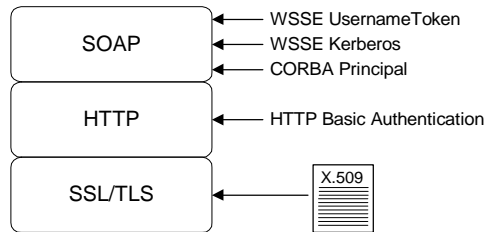

**CORBA binding**

For the CORBA binding, there are only two protocol layers (CORBA binding and IIOP/TLS). This is because CORBA is compatible with only one kind of message format (that is, GIOP). [Figure 8](#) shows the protocol layers and the kinds of authentication available to the CORBA binding.

**Figure 8:** *Protocol Layers in a CORBA Binding*

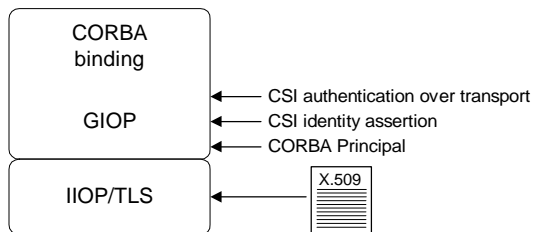



---

# Security Layer

---

## Overview

The *security layer* is responsible for implementing a variety of different security features with the exception, however, of propagating security credentials, which is the responsibility of the protocol layers. The security layer is at least partially responsible for implementing the following security features:

- [Authentication](#).
- [Authorization](#).
- [Single sign-on](#).

---

## Authentication

On the server side, the security layer selects one of the client credentials (a server can receive more than one kind of credentials from a client) and calls the central Artix security service to authenticate the credentials. If the authentication call succeeds, the security layer proceeds to make an authorization check; otherwise, an exception is thrown back to the client.

---

## Authorization

The security layer makes an authorization check by matching a user's roles and realms against the ACL entries in an *action-role mapping file*. If the user does not have permission to invoke the current action (that is, WSDL operation), an exception is thrown back to the client.

---

## Single sign-on

Single sign-on is an optional feature that increases security by reducing the number of times that a user's credentials are sent across the network. The security layer works in tandem with the login service to provide the single sign-on feature.

---

## Artix security plug-in

The Artix security plug-in provides the security layer for all Artix bindings except CORBA. The ASP security layer is loaded, if `artix_security` is listed in the `orb_plugins` list in the Artix domain configuration, `artix.cfg`.

---

## GSP security plug-in

The GSP security plug-in provides the security layer for the CORBA binding only. The GSP security layer is loaded, if `gsp` is listed in the `orb_plugins` list in the Artix domain configuration, `artix.cfg`.

## Using Multiple Bindings

### Overview

Figure 9 shows an example of an advanced application that uses multiple secure bindings.

**Figure 9:** *Example of an Application with Multiple Bindings*

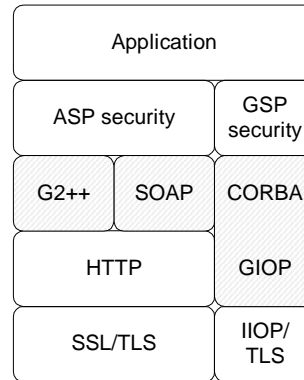

This type of application might be used as a bridge, for example, to link a CORBA domain to a SOAP domain. Alternatively, the application might be a server designed as part of a migration strategy, where the server can support requests in multiple formats, such as G2++, SOAP, or CORBA.

### Example bindings

The following bindings are used in the application shown in Figure 9:

- G2++—consisting of the following layers: ASP security, G2++ binding, HTTP, SSL/TLS.
- SOAP—consisting of the following layers: ASP security, SOAP binding, HTTP, SSL/TLS.
- CORBA—consisting of the following layers: GSP security, CORBA binding, GIOP, IIOP/TLS.

---

# Caching of Credentials

---

## Overview

To improve the performance of servers within the Artix Security Framework, both the GSP plug-in (CORBA binding only) and the artix security plug-in (all other bindings) implement caching of credentials (that is, the authentication and authorization data received from the Artix security service).

The credentials cache reduces a server's response time by reducing the number of remote calls to the Artix security service. On the first call from a given user, the server calls the Artix security service and caches the received credentials. On subsequent calls from the same user, the cached credentials are used, thereby avoiding a remote call to Artix security service.

---

## Cache time-out

The cache can be configured to time-out credentials, forcing the server to call the Artix security service again after using cached credentials for a certain period.

---

## Cache size

The cache can also be configured to limit the number of stored credentials.

---

## GSP configuration variables

The following variables configure the credentials cache for CORBA bindings:

`plugins:gsp:authentication_cache_size`

The maximum number of credentials stored in the authentication cache. If this size is exceeded the oldest credential in the cache is removed.

A value of -1 (the default) means unlimited size. A value of 0 means disable the cache.

`plugins:gsp:authentication_cache_timeout`

The time (in seconds) after which a credential is considered *stale*. Stale credentials are removed from the cache and the server must re-authenticate with the Artix security service on the next call from that user.

A value of -1 (the default) means an infinite time-out. A value of 0 means disable the cache.

## ASP configuration variables

---

The following variables configure the credentials cache for all non-CORBA bindings:

`plugins:asp:authentication_cache_size`

The maximum number of credentials stored in the authentication cache. If this size is exceeded the oldest credential in the cache is removed.

A value of -1 (the default) means unlimited size. A value of 0 means disable the cache.

`plugins:asp:authentication_cache_timeout`

The time (in seconds) after which a credential is considered *stale*. Stale credentials are removed from the cache and the server must re-authenticate with the Artix security service on the next call from that user.

A value of -1 (the default) means an infinite time-out. A value of 0 means disable the cache.

# Security for HTTP-Compatible Bindings

*This chapter describes the security features supported by the Artix HTTP plug-in. These security features are available to any Artix binding that can be layered on top of the HTTP transport.*

---

## In this chapter

This chapter discusses the following topics:

<a href="#">Overview of HTTP Security</a>	page 48
<a href="#">Securing HTTP Communications with SSL/TLS</a>	page 51
<a href="#">HTTP Basic Authentication</a>	page 62
<a href="#">X.509 Certificate-Based Authentication</a>	page 66

# Overview of HTTP Security

## Overview

Figure 10 gives an overview of HTTP security within the Artix security framework, showing the various security layers (ASP, binding layer, HTTP, and SSL/TLS) and the different authentication types associated with the security layers. Because many different binding types (for example, SOAP or G2++) can be layered on top of HTTP, Figure 10 does not specify a particular binding layer. Any HTTP-compatible binding could be substituted into this architecture.

**Figure 10:** HTTP-Compatible Binding Security Layers

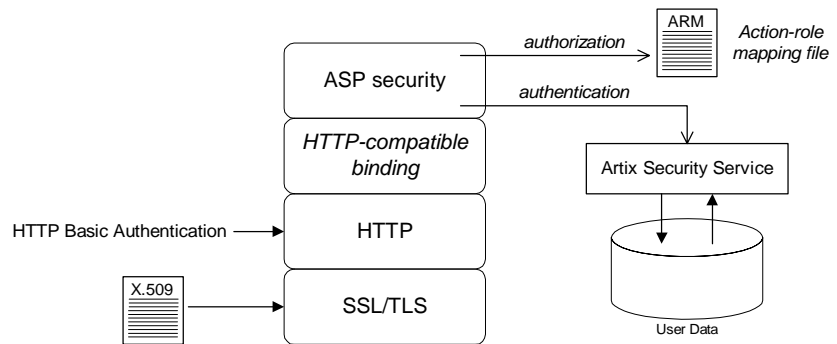

## Security layers

As shown in Figure 10, a HTTP-compatible binding has the following security layers:

- [SSL/TLS layer](#).
- [HTTP layer](#).
- [HTTP-compatible binding layer](#).
- [ASP security layer](#).

## SSL/TLS layer

The SSL/TLS layer provides guarantees of confidentiality, message integrity, and authentication (using X.509 certificates). The TLS functionality is integrated into the `https` plug-in.

The `https` plug-in is configured by editing the Artix configuration file, `artix.cfg`.

## HTTP layer

The HTTP layer supports the sending of username/password data in the HTTP message header—that is, *HTTP Basic Authentication*. HTTP Basic Authentication is configured by editing an application's WSDL contract.

In Artix, the HTTP/S protocol is implemented by the following plug-ins:

- `at_http` plug-in—this plug-in is a thin layer that integrates the other two plug-ins, `http` and `https`, with the Artix core. The `at_http` plug-in is automatically loaded, if either the `<http-conf:client>` or `<http-conf:server>` tags appear amongst the WSDL port settings.
- `http` plug-in—implements *insecure* HTTP only. The `http` plug-in is automatically loaded by the `at_http` plug-in.
- `https` plug-in—implements *secure* HTTPS only. The `https` plug-in must be added explicitly to the `orb_plugins` list in order to load.

**Note:** In versions of Artix prior to 3.0, one plug-in, `http`, provided all of the HTTP/S functionality. In Artix 3.0, it was refactored into three separate plug-ins. Hence, the pre-Artix 3.0 `http` plug-in is a completely different plug-in from the post-Artix 3.0 `http` plug-in.

## HTTP-compatible binding layer

The HTTP-compatible binding layer could provide additional security features (for example, propagation of security credentials), depending on the type of binding. The following binding types are HTTP-compatible:

- SOAP binding.
- XML format binding.
- G2++ binding.
- Fixed record length binding.
- Tagged data binding.
- MIME binding.

## ASP security layer

The ASP security layer is implemented by the Artix security plug-in, which provides authentication and authorization checks for all binding types, except the CORBA binding, as follows:

- *Authentication*—by selecting one of the available client credentials and calling out to the Artix security service to check the credentials.
  - *Authorization*—by reading an action-role mapping (ARM) file and checking whether a user’s roles allow it to perform a particular action.
- 

**Authentication options**

The following authentication options are common to all HTTP-compatible bindings:

- [HTTP Basic Authentication](#).
  - [X.509 certificate-based authentication](#).
- 

**HTTP Basic Authentication**

HTTP Basic Authentication works by sending a username and password embedded in the HTTP message header. This style of authentication is commonly used by clients running in a Web browser.

For details of HTTP Basic Authentication, see [“HTTP Basic Authentication” on page 62](#).

---

**X.509 certificate-based authentication**

X.509 certificate-based authentication is an authentication step that is performed *in addition to* the checks performed at the socket layer during the SSL/TLS security handshake.

For details of X.509 certificate-based authentication, see [“X.509 Certificate-Based Authentication” on page 66](#).



---

# Securing HTTP Communications with SSL/TLS

## Overview

This subsection describes how to configure the HTTP transport to use SSL/TLS security, a combination usually referred to as HTTPS. In Artix, HTTPS security is implemented by a combination of the `at_http` and `https` plug-ins and configured by settings in the `artix.cfg` file.

The following topics are discussed in this subsection:

- [Generating X.509 certificates.](#)
- [Enabling HTTPS.](#)
- [HTTPS client with no certificate.](#)
- [HTTPS client with certificate.](#)
- [HTTPS server configuration.](#)

---

## Generating X.509 certificates

A basic prerequisite for using SSL/TLS security is to have a collection of X.509 certificates available to identify your server applications and, optionally, your client applications. You can generate X.509 certificates in one of the following ways:

- Use a commercial third-party tool to generate and manage your X.509 certificates.
- Use the free `openssl` utility (which can be downloaded from <http://www.openssl.org>)—see “[Creating Your Own Certificates](#)” on [page 235](#) for details of how to use it.

## Enabling HTTPS

There are two approaches to enabling HTTPS, depending on whether or not the configuration in the WSDL contract explicitly specifies a HTTPS URL.

### HTTPS specified in the WSDL contract

The usual way to enable HTTPS is by specifying the endpoint address in the WSDL contract as an URL with the `https:` prefix. For example, to enable SOAP over HTTPS, you would specify the endpoint address as follows:

```
<wsdl:definitions name="HelloWorld"
  targetNamespace="http://www.iona.com/hello_world_soap_http"
  xmlns:soap="http://schemas.xmlsoap.org/wsdl/soap/"
  xmlns:wsdl="http://schemas.xmlsoap.org/wsdl/" ... >
  ...
  <wsdl:service name="SOAPService">
    <wsdl:port binding="tns:Greeter_SOAPBinding"
      name="SoapPort">
      <soap:address location="https://localhost:9000"/>
    </wsdl:port>
  </wsdl:service>
</wsdl:definitions>
```

Where the `location` attribute of the `soap:address` element is configured to use a HTTPS URL. For bindings other than SOAP, you would edit the URL appearing in the `location` attribute of the `http:address` element.

### HTTPS not specified in the WSDL contract

If the endpoint address in the WSDL contract is specified as an URL with the `http:` prefix (insecure HTTP), it is possible to force the endpoint to use SSL/TLS security by editing the Artix configuration file, setting `plugins:at_http:client:use_secure_sockets` to `true` on the client side and `plugins:at_http:server:use_secure_sockets` to `true` on the server side. In general, however, it is better to specify the HTTPS protocol by modifying the URL in the WSDL contract (the first approach).

**HTTPS client with no certificate**

For example, consider the configuration for a secure HTTPS client with no certificate. [Example 9](#) shows how to configure such a sample client.

**Example 9: Sample HTTPS Client with No Certificate**

```

# Artix Configuration File
...
# General configuration at root scope.
...
my_secure_apps {
  # Common SSL/TLS configuration settings.
1 orb_plugins = ["xml_log_stream", ..., "at_http", "https"];

  binding:client_binding_list = ["GIOP+EGMIOP",
  "OTS+TLS_Coloc+POA_Coloc", "TLS_Coloc+POA_Coloc",
  "OTS+POA_Coloc", "POA_Coloc", "GIOP+SHMIOP",
  "CSI+OTS+GIOP+IIOP_TLS", "OTS+GIOP+IIOP_TLS",
  "CSI+GIOP+IIOP_TLS", "GIOP+IIOP_TLS", "CSI+OTS+GIOP+IIOP",
  "OTS+GIOP+IIOP", "CSI+GIOP+IIOP", "GIOP+IIOP"];

2 policies:https:trusted_ca_list_policy =
  "ArtixInstallDir\artix\Version\demos\secure_hello_world\http
  soap\certificates\tls\x509\trusted_ca_lists\ca_list1.pem";

3 policies:https:mechanism_policy:protocol_version = "SSL_V3";
  policies:https:mechanism_policy:ciphersuites =
  ["RSA_WITH_RC4_128_SHA", "RSA_WITH_RC4_128_MD5"];

4 event_log:filters = ["IT_ATLI_TLS=*", "IT_IIOP=*",
  "IT_IIOP_TLS=*", "IT_TLS=*"];
  ...
  my_client {
5     # Specific HTTPS client configuration settings
    principal_sponsor:use_principal_sponsor = "false";

6     policies:client_secure_invocation_policy:requires =
    ["Confidentiality", "Integrity", "DetectReplay",
    "DetectMisordering", "EstablishTrustInTarget"];
    policies:client_secure_invocation_policy:supports =
    ["Confidentiality", "Integrity", "DetectReplay",
    "DetectMisordering", "EstablishTrustInTarget"];
  };
};
...

```

The preceding client configuration can be described as follows:

1. The `at_http` and `https` plug-ins together provide support for the HTTP and HTTPS protocols. You can optionally include these plug-ins in the `orb_plugins` list. If they are not explicitly listed, Artix will automatically load them when necessary.

**Note:** Loading the `https` plug-in is *not* sufficient to make a service secure. You must also configure the endpoints to have HTTPS URLs in the WSDL contract—see [“Enabling HTTPS” on page 52](#).

If you plan to use the full Artix Security Framework, you should include the ASP plug-in, `artix_security`, in the ORB plug-ins list as well.

2. A HTTPS application needs a list of trusted CA certificates, which it uses to determine whether or not to trust certificates received from other HTTPS applications. You must, therefore, edit the `policies:https:trusted_ca_list_policy` variable to point at a list of trusted certificate authority (CA) certificates. See [“Specifying Trusted CA Certificates” on page 267](#).
3. The mechanism policy specifies the default security protocol version and the available cipher suites—see [“Specifying Cipher Suites” on page 295](#).
4. This line enables console logging for security-related events, which is useful for debugging and testing. Because there is a performance penalty associated with this option, you might want to comment out or delete this line in a production system.
5. The SSL/TLS principal sponsor is a mechanism that can be used to specify an application’s own X.509 certificate. Because this client configuration does not use a certificate, the principal sponsor is disabled by setting `principal_sponsor:use_principal_sponsor` to `false`.
6. The following two lines set the *required* options and the *supported* options for the HTTPS client secure invocation policy. In this example, the policy is set as follows:
  - ◆ Required options—the options shown here ensure that the client can open only secure HTTPS connections.

- ◆ Supported options—the options shown include all of the association options, except for the `EstablishTrustInClient` option. The client cannot support `EstablishTrustInClient`, because it has no X.509 certificate.

## HTTPS client with certificate

For example, consider a secure HTTPS client that is configured to have its own certificate. [Example 10](#) shows how to configure such a sample client.

### Example 10: Sample HTTPS Client with Certificate

```
# Artix Configuration File
...
# General configuration at root scope.
...
my_secure_apps {
    # Common SSL/TLS configuration settings.
    orb_plugins = ["xml_log_stream", ..., "at_http", "https"];

    binding:client_binding_list = ["GIOP+EGMIOP",
    "OTS+TLS_Coloc+POA_Coloc", "TLS_Coloc+POA_Coloc",
    "OTS+POA_Coloc", "POA_Coloc", "GIOP+SHMIOP",
    "CSI+OTS+GIOP+IIOP_TLS", "OTS+GIOP+IIOP_TLS",
    "CSI+GIOP+IIOP_TLS", "GIOP+IIOP_TLS", "CSI+OTS+GIOP+IIOP",
    "OTS+GIOP+IIOP", "CSI+GIOP+IIOP", "GIOP+IIOP"];

    policies:https:trusted_ca_list_policy =
    "ArtixInstallDir\artix\Version\demos\secure_hello_world\http_
    soap\certificates\tls\x509\trusted_ca_lists\ca_list1.pem";

    policies:https:mechanism_policy:protocol_version = "SSL_V3";
    policies:https:mechanism_policy:ciphersuites =
    ["RSA_WITH_RC4_128_SHA", "RSA_WITH_RC4_128_MD5"];

    event_log:filters = ["IT_ATLI_TLS=*", "IT_IIOP=*",
    "IT_IIOP_TLS=*", "IT_TLS=*"];
    ...
    my_client {
        # Specific HTTPS client configuration settings
        1 principal_sponsor:use_principal_sponsor = "true";
        2 principal_sponsor:auth_method_id = "pkcs12_file";
        3 principal_sponsor:auth_method_data =
        ["filename=C:\artix_30\artix\3.0\demos\security\certificates\
        openssl\x509\certs\testaspen.p12"];
    }
}
```

**Example 10: Sample HTTPS Client with Certificate**

```

4  policies:client_secure_invocation_policy:requires =
    ["Confidentiality", "Integrity", "DetectReplay",
     "DetectMisordering", "EstablishTrustInTarget"];
    policies:client_secure_invocation_policy:supports =
    ["Confidentiality", "Integrity", "DetectReplay",
     "DetectMisordering", "EstablishTrustInTarget",
     "EstablishTrustInClient"];
    };
    ...

```

The preceding client configuration can be described as follows:

1. The SSL/TLS principal sponsor is a mechanism that can be used to specify an application's own X.509 certificate. The principal sponsor is enabled by setting `principal_sponsor:use_principal_sponsor` to `true`.
2. This line specifies that the X.509 certificate is contained in a PKCS#12 file. For alternative methods, see [“Specifying an Application's Own Certificate” on page 268](#).
3. Specify the X.509 certificate location by editing the `filename` value to point at a custom X.509 certificate file, which should be in PKCS#12 format—see [“Specifying an Application's Own Certificate” on page 268](#) for more details.

For details of how to specify the certificate's pass phrase, see [“Certificate Pass Phrase for HTTPS and IIOP/TLS” on page 270](#).

4. The following two lines set the *required* options and the *supported* options for the client secure invocation policy. In this example, the policy is set as follows:
  - ◆ Required options—the options shown here ensure that the client can open only secure HTTPS connections.
  - ◆ Supported options—the association options shown here include the `EstablishTrustInClient` option. This association option must be supported when the client has an X.509 certificate.

Alternatively, you could configure security for a HTTPS client by editing the port settings in the WSDL contract (but only for *mutual authentication*).

[Example 11](#) shows how to configure the client side of a HTTPS connection in Artix, in the case of mutual authentication.

### Example 11: WSDL Contract for HTTPS Client with Certificate

```

<definitions name="HelloWorldService"
  targetNamespace="http://xmlbus.com/HelloWorld"
  xmlns:soap="http://schemas.xmlsoap.org/wsdl/soap/"
  xmlns:http-conf="http://schemas.iona.com/transport/http/configuration" ... >
  ...
  <service name="HelloWorldService">
    <port binding="tns:HelloWorldPortBinding"
      name="HelloWorldPort">
      <soap:address location="https://localhost:55012"/>
      <http-conf:client
        UseSecureSockets="true"
        TrustedRootCertificates="../certificates/openssl/x509/ca/cacert.
1 ClientCertificate="../certificates/openssl/x509/certs/client_cer
2 t.p12"
        ClientPrivateKeyPassword="ClientPrivKeyPass"
      />
    </port>
  </service>
</definitions>

```

The preceding WSDL contract can be described as follows:

1. The `ClientCertificate` attribute specifies the client's own certificate in PKCS#12 format.
2. The `ClientPrivateKeyPassword` attribute specifies the password to decrypt the contents of the `ClientCertificate` file.

**Note:** The presence of the private key password in the WSDL contract file implies that this file must be read and write-protected to prevent unauthorized users from obtaining the password.

**WARNING:** If you include security settings in the WSDL contract and you have loaded the WSDL publish plug-in, it is recommended that you configure the WSDL publishing service to be secure. See [“Publishing WSDL Securely” on page 123](#).

**HTTPS server configuration**

Generally speaking, it is rarely necessary to configure such a thing as a *pure server* (that is, a server that never makes any requests of its own). Most real servers are applications that act in both a server role and a client role. The sample server described here combines the following qualities: in the server role, the application requests clients to send a certificate; in the client role, the application requires security and includes a certificate.

[Example 12](#) shows how to configure such a sample server.

**Example 12: Sample HTTPS Server Configuration**

```

# Artix Configuration File
...
# General configuration at root scope.
...
my_secure_apps {
1   # Common SSL/TLS configuration settings.
    ...
    my_server {
2       # Specific HTTPS server configuration settings
        policies:target_secure_invocation_policy:requires =
["Confidentiality", "Integrity", "DetectReplay",
"DetectMisordering"];
        policies:target_secure_invocation_policy:supports =
["EstablishTrustInClient", "Confidentiality", "Integrity",
"DetectReplay", "DetectMisordering",
"EstablishTrustInTarget"];
3
4       principal_sponsor:use_principal_sponsor = "true";
5       principal_sponsor:auth_method_id = "pkcs12_file";
        principal_sponsor:auth_method_data =
["filename=CertsDir\server_cert.p12"];

        # Specific HTTPS client configuration settings
6       policies:client_secure_invocation_policy:requires =
["Confidentiality", "Integrity", "DetectReplay",
"DetectMisordering", "EstablishTrustInTarget"];
        policies:client_secure_invocation_policy:supports =
["Confidentiality", "Integrity", "DetectReplay",
"DetectMisordering", "EstablishTrustInClient",
"EstablishTrustInTarget"];
    };
};
...

```



The preceding server configuration can be described as follows:

1. You can use the same common SSL/TLS settings here as described in the preceding [“HTTPS client with no certificate” on page 53](#).
2. The following two lines set the *required* options and the *supported* options for the target secure invocation policy. In this example, the policy is set as follows:
  - ◆ Required options—the options shown here ensure that the server accepts only secure HTTPS connection attempts.
  - ◆ Supported options—all of the target association options are supported.
3. A secure server must always be associated with an X.509 certificate. Hence, this line enables the SSL/TLS principal sponsor, which specifies a certificate for the application.
4. This line specifies that the X.509 certificate is contained in a PKCS#12 file. For alternative methods, see [“Specifying an Application’s Own Certificate” on page 268](#).
5. Specify the location of the X.509 certificate file, by editing the `filename` value to point at a custom X.509 certificate, which should be in PKCS#12 format—see [“Specifying an Application’s Own Certificate” on page 268](#) for more details.

For details of how to specify the certificate’s pass phrase, see [“Certificate Pass Phrase for HTTPS and IIOP/TLS” on page 270](#).
6. The following two lines set the *required* options and the *supported* options for the client secure invocation policy. In this example, the policy is set as follows:
  - ◆ Required options—the options shown here ensure that the application can open only secure SSL/TLS connections to other servers.
  - ◆ Supported options—all of the client association options are supported. In particular, the `EstablishTrustInClient` option is supported when the application is in a client role, because the application has an X.509 certificate.

Alternatively, you could configure security for a HTTPS server by editing the port settings in the WSDL contract (but only for *mutual authentication*).

[Example 13](#) shows how to configure the server side of a HTTPS connection for mutual authentication in Artix.

### Example 13: WSDL Contract with Server HTTPS Configuration

```

<definitions name="HelloWorldService"
  targetNamespace="http://xmlbus.com/HelloWorld"
  xmlns:soap="http://schemas.xmlsoap.org/wsdl/soap/"
  xmlns:http-conf="http://schemas.ionas.com/transports/http/configuration" ... >
  ...
  <service name="HelloWorldService">
    <port binding="tns:HelloWorldPortBinding"
      name="HelloWorldPort">
1      <soap:address location="https://localhost:55012"/>
2      <http-conf:server
3          UseSecureSockets="true"
4      ServerCertificate="../certificates/openssl/x509/certs/server_certificate.p12"
5          ServerPrivateKeyPassword="ServerPrivKeyPass"
6      TrustedRootCertificates="../certificates/openssl/x509/ca/cacert.p12"
          />
    </port>
  </service>
</definitions>

```

The preceding WSDL contract can be described as follows:

1. The fact that this is a secure connection is signalled by using `https:` instead of `http:` in the location URL attribute.
2. The `<http-conf:server>` tag contains all the attributes for configuring the server side of the HTTPS connection.
3. If the `UseSecureSockets` attribute is `true`, the server will open a port to listen for secure connections.

**Note:** If `UseSecureSockets` is `false` and the `<soap:address>` location URL begins with `https:`, however, the server will listen for secure connections.

4. The `ServerCertificate` attribute specifies the server's own certificate in PKCS#12 format. For more background details about X.509 certificates, see [“Managing Certificates” on page 225](#).
5. The `ServerPrivateKeyPassword` attribute specifies the password to decrypt the server certificate's private key.

**Note:** The presence of the private key password in the WSDL contract file implies that this file must be read and write-protected to prevent unauthorized users from obtaining the password.

For the same reason, it is also advisable to remove the `<http-conf:server>` tag from the copy of the WSDL contract that is distributed to clients.

6. The file specified by the `TrustedRootCertificates` contains a concatenated list of CA certificates in PKCS#12 format. This attribute value is needed for mutual authentication (for checking the certificates sent by clients).

**WARNING:** If you include security settings in the WSDL contract and you have loaded the WSDL publish plug-in, it is recommended that you configure the WSDL publishing service to be secure. See [“Publishing WSDL Securely” on page 123](#).

# HTTP Basic Authentication

## Overview

This section describes how to configure an Artix client and server to use HTTP Basic Authentication. With HTTP Basic Authentication, username/password credentials are sent in a HTTP header.

For more details, see the [W3 specification](http://www.w3.org/Protocols/HTTP/1.0/spec.html) (<http://www.w3.org/Protocols/HTTP/1.0/spec.html>) for HTTP/1.0.

## HTTP Basic Authentication client configuration

**Example 14** shows how to configure a client WSDL contract to use HTTP Basic Authentication.

### Example 14: WSDL Contract with Client HTTP Basic Authentication

```

<definitions name="HelloWorldService"
  targetNamespace="http://xmlbus.com/HelloWorld"
  xmlns:soap="http://schemas.xmlsoap.org/wsdl/soap/"
  xmlns:http-conf="http://schemas.iona.com/transports/http/configu
1   ration"
  xmlns:bus-security="http://schemas.iona.com/bus/security"
  ... >
  ...
  <service name="HelloWorldService">
    <port binding="tns:HelloWorldPortBinding"
2     name="HelloWorldPort">
      <soap:address location="https://localhost:55012"/>
      <http-conf:client
3         ...
4         UserName="user_test"
         Password="user_password"
5       />
      <bus-security:security enableSecurity="true" />
    </port>
  </service>
</definitions>

```

The preceding WSDL contract can be described as follows:

1. The `bus-security` namespace prefix is needed for the ASP plug-in settings.
2. In this example, HTTP Basic Authentication is combined with SSL/TLS security (see [“Securing HTTP Communications with SSL/TLS” on page 51](#)). This ensures that the username and password are transmitted across an encrypted connection, protecting them from snooping.
3. The `UserName` attribute sets the user name for the HTTP Basic Authentication credentials.
4. The `Password` attribute sets the password for the HTTP Basic Authentication credentials.
5. The presence of the `<bus-security:security>` tag ensures that the ASP plug-in, `artix_security`, is loaded into your application. This plug-in is responsible for the authentication and authorization features.

**WARNING:** If you include security settings in the WSDL contract and you have loaded the WSDL publish plug-in, it is recommended that you configure the WSDL publishing service to be secure. See [“Publishing WSDL Securely” on page 123](#).

## HTTP Basic Authentication server configuration

There is no need to make any modifications to the WSDL contract for servers that support HTTP Basic Authentication.

However, it is necessary to make modifications to the domain configuration file, `artix.cfg` (in the `ArtixInstallDir/artix/Version/etc/domains` directory), as shown in [Example 15](#).

### Example 15: Artix Configuration for Server HTTP Basic Authentication

```
# Artix Configuration File
security_artix {
    ...
    demos
    {
        hello_world
        {
            plugins:artix_security:shlib_name="it_security_plugin";
        }
    }
}
```

**Example 15:** *Artix Configuration for Server HTTP Basic Authentication*

```

1      binding:artix:server_request_interceptor_list=
      "security";
      binding:client_binding_list = ["OTS+POA_Coloc",
2      "POA_Coloc", "OTS+GIOP+IIOP", "GIOP+IIOP", "GIOP+IIOP_TLS"];
      orb_plugins = ["xmlfile_log_stream", ..., "at_http",
3      "artix_security", "https"];
      plugins:is2_authorization:action_role_mapping =
4      "file://ArtixInstallDir/artix/Version/demos/secure_hello_world/http_soap/config/helloworld_action_role_mapping.xml";
5      policies:asp:enable_authorization = "true";
6      plugins:asp:security_level = "MESSAGE_LEVEL";
      plugins:asp:authentication_cache_size = "5";
      plugins:asp:authentication_cache_timeout = "10";
      };
      ...
};
};

```

The preceding extract from the domain configuration can be explained as follows:

1. The Artix server request interceptor list must include the `security` interceptor, which provides part of the functionality for the Artix security layer.
2. The `orb_plugins` list should include the `artix_security` plug-in, which is responsible for enabling authentication and authorization.
3. The action-role mapping file is used to apply access control rules to the authenticated user. The file determines which actions (that is, WSDL operations) can be invoked by an authenticated user, on the basis of the roles assigned to that user.  
See [“Managing Access Control Lists” on page 215](#) for more details.
4. The `policies:asp:enable_authorization` variable must be set to `true` to enable authorization.
5. The `plugins:asp:security_level` configuration variable specifies the type of credentials authenticated on the server side. The `MESSAGE_LEVEL` security type, selects the username/password credentials from the HTTP Basic Authentication header.

6. The next pair of configuration variables configure the `asp` caching mechanism. For more details, see [“ASP configuration variables” on page 46](#).

# X.509 Certificate-Based Authentication

## Overview

This section describes how to enable X.509 certificate authentication for HTTP-compatible bindings, based on a simple two-tier client/server scenario. In this scenario, the Artix security service authenticates the client's certificate and retrieves roles and realms based on the identity of the certificate subject. When certificate-based authentication is enabled, the X.509 certificate is effectively authenticated twice, as follows:

- *SSL/TLS-level authentication*—this authentication step occurs during the SSL/TLS handshake and is governed by the HTTPS configuration settings in the Artix configuration file, `artix.cfg`.
- *Artix security-level authentication and authorization*—this authentication step occurs after the SSL/TLS handshake and is performed by the Artix security service working in tandem with the `artix_security` plug-in.

## Certificate-based authentication scenario

Figure 11 shows an example of a two-tier system, where authentication of the client's X.509 certificate is integrated with the Artix security service.

**Figure 11:** Overview of Certificate-Based Authentication with HTTPS

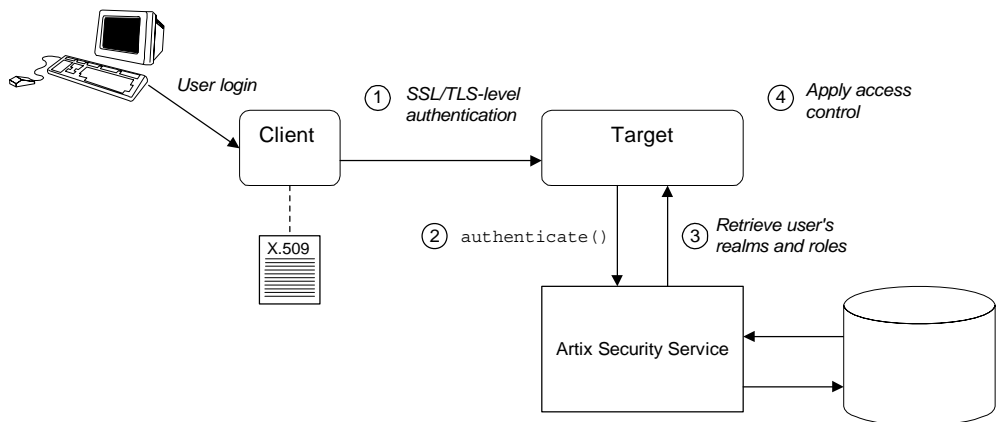



## Scenario description

The scenario shown in [Figure 11](#) can be described as follows:

Stage	Description
1	<p>When the client opens a connection to the server, the client sends its X.509 certificate as part of the SSL/TLS handshake (HTTPS). The server then performs SSL/TLS-level authentication, checking the certificate as follows:</p> <ul style="list-style-type: none"> <li>• The certificate is checked against the server's <i>trusted CA list</i> to ensure that it is signed by a trusted certification authority.</li> <li>• The server sends a challenge to the client, which requires the client to prove that it possesses the certificate's private key.</li> </ul>
2	<p>The server performs security layer authentication by calling <code>authenticate()</code> on the Artix security service, passing a copy of the client's certificate to the Artix security service.</p> <p>The details of this authentication step depend on the particular security adapter that is plugged into the Artix security service. For example, the file adapter would authenticate the client certificate as follows:</p> <ul style="list-style-type: none"> <li>• The user's identity is extracted from the certificate's subject DN.</li> <li>• To verify the user's identity, the file adapter compares the client certificate with a cached copy. The authentication succeeds, only if the certificates are equal.</li> </ul>
3	<p>If authentication is successful, the Artix security service returns the user's realms and roles.</p>
4	<p>The ASP security layer controls access to the target's WSDL operations by consulting an <i>action-role mapping file</i> to determine what the user is allowed to do.</p>

---

**Credentials priority**

When performing authentication at the Artix security level, the X.509 certificate credentials have a *lower* priority than HTTP Basic Authentication credentials. Hence, if both HTTP Basic Authentication credentials and X.509 certificate credentials are presented, the credentials from HTTP Basic Authentication are used to perform authentication and authorization at the Artix security layer.

---

**HTTPS prerequisites**

In general, a basic prerequisite for using X.509 certificate-based authentication is that both client and server are configured to use HTTPS. See [“Securing HTTP Communications with SSL/TLS” on page 51](#).

---

**Certificate-based authentication security service configuration**

A basic prerequisite for using certificate-based authentication is to configure the security adapter that plugs into the Artix security service. The details of this configuration step are specific to each security adapter. Typically, it involves caching copies of the X.509 certificates for all users with security privileges.

Specific details of how to configure each adapter for certificate-based authentication are available, as follows:

- *File adapter*—see [“Certificate-based authentication for the file adapter” on page 212](#).
  - *LDAP adapter*—see [“Certificate-based authentication for the LDAP adapter” on page 214](#).
  - *Custom adapter*—see [“Developing an iSF Adapter” on page 375](#).
- 

**Certificate-based authentication client configuration**

To enable certificate-based authentication on the client side, it is sufficient for the client to be configured to use HTTPS with its own certificate. For example, see [“HTTPS client with certificate” on page 55](#).

## Certificate-based authentication server configuration

A prerequisite for using certificate-based authentication on the server side is that the server's WSDL contract is configured to use HTTPS. For example, see [“HTTPS server configuration” on page 58](#).

Additionally, on the server side it is also necessary to configure the ASP security layer by editing the `artix-secure.cfg` domain configuration file (in the `ArtixInstallDir/artix/Version/etc/domains` directory), as shown in [Example 16](#).

### Example 16: Artix Configuration for X.509 Certificate-Based Authentication

```
# Artix Configuration File
security_artix {
    ...
    demos
    {
        hello_world
        {
            plugins:artix_security:shlib_name =
1         "it_security_plugin";
            binding:artix:server_request_interceptor_list=
2         "security";
            binding:client_binding_list = ["OTS+POA_Coloc",
3         "POA_Coloc", "OTS+GIOP+IIOP", "GIOP+IIOP", "GIOP+IIOP_TLS"];
            orb_plugins = ["xmlfile_log_stream", ..., "at_http",
4         "artix_security", "https"];
            plugins:is2_authorization:action_role_mapping =
5         "file://ArtixInstallDir/artix/2.0/demos/secure_hello_world/ht
6         tp_soap/config/helloworld_action_role_mapping.xml";
            policies:asp:enable_authorization = "true";
            plugins:asp:security_level = "MESSAGE_LEVEL";
            plugins:asp:authentication_cache_size = "5";
            plugins:asp:authentication_cache_timeout = "10";
7         plugins:asp:enable_security_service_cert_authentication = "true";
8
            # SSL/TLS Settings for HTTPS Transport
            ...
            };
            ...
        };
    };
};
```

The preceding extract from the domain configuration can be explained as follows:

1. The Artix server request interceptor list must include the `security` interceptor, which provides part of the functionality for the Artix security layer.
2. The `orb_plugins` list should include the `artix_security` plug-in, which is responsible for enabling authentication and authorization. You can optionally include the `https` plug-in, which implements the HTTPS transport protocol (if you don't include it here, it will be loaded dynamically in any case).
3. The action-role mapping file is used to apply access control rules to the authenticated user. The file determines which actions (that is, WSDL operations) can be invoked by an authenticated user, on the basis of the roles assigned to that user.  
See [“Managing Access Control Lists” on page 215](#) for more details.
4. `policies:asp:enable_authorization` variable must be set to `true` to enable authorization.
5. The `plugins:asp:security_level` configuration variable specifies whether the credentials are taken from a request-level header or from a transport-level header. By setting the security level to `MESSAGE_LEVEL`, you indicate that the credentials are taken either from HTTP Basic Authentication credentials or from an X.509 certificate at the SSL/TLS layer.
6. The next pair of configuration variables configure the ASP caching mechanism. For more details, see [“ASP configuration variables” on page 46](#).
7. The `plugins:asp:enable_security_service_cert_authentication` variable must be set to `true` in order to enable X.509 certificate authentication at the Artix security level.
8. You also need to include the settings for configuring the SSL/TLS layer. See [“HTTPS server configuration” on page 58](#) for details.

# Security for SOAP Bindings

*This chapter describes the security features that are specific to the SOAP binding—for example, such as security credentials that can be propagated in a SOAP header.*

---

**In this chapter**

This chapter discusses the following topic:

<a href="#">Overview of SOAP Security</a>	<a href="#">page 72</a>
<a href="#">WSSE X.509 Certificates and Authentication</a>	<a href="#">page 76</a>

# Overview of SOAP Security

## Overview

Figure 12 gives an overview of security for a SOAP binding within the Artix security framework. SOAP security consists of four different layers (SSL/TLS, HTTP, SOAP, and ASP) and support is provided for several different types of credentials. Figure 12 shows you how the different credential types are associated with the different security layers.

**Figure 12:** Overview of Security for SOAP Bindings

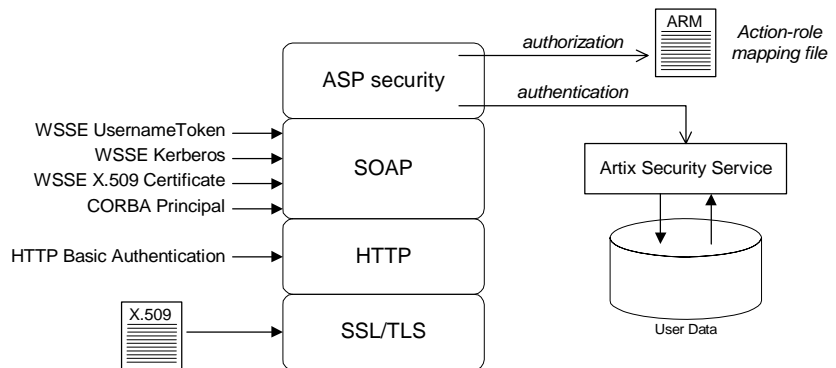

## Security layers

As shown in Figure 12, the SOAP binding includes the following security layers:

- [SSL/TLS layer](#).
- [HTTP layer](#).
- [SOAP layer](#).
- [ASP security layer](#).

---

**SSL/TLS layer**

The SSL/TLS layer provides the SOAP binding with message encryption, message integrity and authentication using X.509 certificates. The implementation of SSL/TLS that underlies HTTPS is based on the Baltimore security toolkit.

To enable SSL/TLS for HTTP, you must edit the `artix.cfg` file—see [“Securing HTTP Communications with SSL/TLS” on page 51](#).

---

**HTTP layer**

The HTTP layer provides a means of sending username/password credentials in a HTTP header (HTTP Basic Authentication). The HTTP layer relies on SSL/TLS to prevent password snooping.

---

**SOAP layer**

The SOAP layer can send various credentials (WSSE UsernameToken, WSSE Kerberos, WSSE X.509 certificate, and CORBA Principal) embedded in a SOAP message header. The SOAP layer relies on SSL/TLS to prevent password snooping.

---

**ASP security layer**

The ASP security layer implements a variety of security features for non-CORBA bindings. The main features of the ASP security layer are, as follows:

- *Authentication*—the ASP security layer calls the Artix security service (which maintains a database of user data) to authenticate a user’s credentials. If authentication is successful, the Artix security service returns a list of the user’s roles and realms.
- *Authorization*—the ASP security layer matches the user’s roles and realms against an action-role mapping file to determine whether the user has permission to invoke the relevant WSDL operation.

---

**Authentication options**

As shown in [Figure 12 on page 72](#), the SOAP binding supports the following authentication options:

- [WSSE UsernameToken](#).
  - [WSSE Kerberos](#).
  - [WSSE X.509 certificate](#).
  - [CORBA Principal](#).
  - [HTTP Basic Authentication](#).
  - [SSL/TLS X.509 certificate](#).
- 

**WSSE UsernameToken**

The Web service security extension (WSSE) UsernameToken is a username/password combination that can be sent in a SOAP header. The specification of WSSE UsernameToken is contained in the [WSS UsernameToken Profile 1.0](#) document from [OASIS](#) ([www.oasis-open.org](http://www.oasis-open.org)). Currently, the WSSE UsernameToken can be set *only* by programming. See [“Propagating a Username/Password Token” on page 360](#).

---

**WSSE Kerberos**

The WSSE Kerberos specification is used to send a Kerberos security token in a SOAP header. If you use Kerberos, you must also configure the Artix security service to use the Kerberos adapter—see [“Configuring the Kerberos Adapter” on page 175](#). Currently, the WSSE Kerberos token can be set *only* by programming. See [“Propagating a Kerberos Token” on page 365](#).

---

**WSSE X.509 certificate**

The WSSE specification allows you to send an X.509 certificate in a SOAP header. For the purpose of authentication, Artix takes the username to be the common name from the certificate’s subject DN. For details, see [“WSSE X.509 Certificates and Authentication” on page 76](#).

---

**CORBA Principal**

The CORBA Principal is a legacy feature originally defined in the early versions of the CORBA GIOP specification. To facilitate interoperability with early CORBA implementations, the Artix SOAP binding is also able to propagate CORBA Principals. This feature is available only for SOAP over HTTP and a SOAP header is used to propagate the CORBA Principal. For details, see [“Principal Propagation” on page 307](#).



---

**HTTP Basic Authentication**

HTTP Basic Authentication is used to propagate username/password credentials in a HTTP header. This kind of authentication is available to any HTTP-compatible binding.

For details, see [“HTTP Basic Authentication” on page 62](#).

---

**SSL/TLS X.509 certificate**

You can use an X.509 certificate from the SSL/TLS layer for the purpose of performing authentication and authorization at the Artix security layer. This kind of authentication is available to any HTTP-compatible binding.

For details, see [“X.509 Certificate-Based Authentication” on page 66](#).

# WSSE X.509 Certificates and Authentication

## Overview

This section describes how to enable X.509 certificate authentication for certificates extracted from a WSSE SOAP header, based on a simple two-tier client/server scenario. In this scenario, the Artix security service authenticates the client's certificate and retrieves roles and realms based on the identity of the certificate subject.

## Certificate-based authentication scenario

Figure 13 shows an example of a two-tier system, where authentication of the client's WSSE X.509 certificate is integrated with the Artix security service.

**Figure 13:** Overview of Certificate-Based Authentication with WSSE

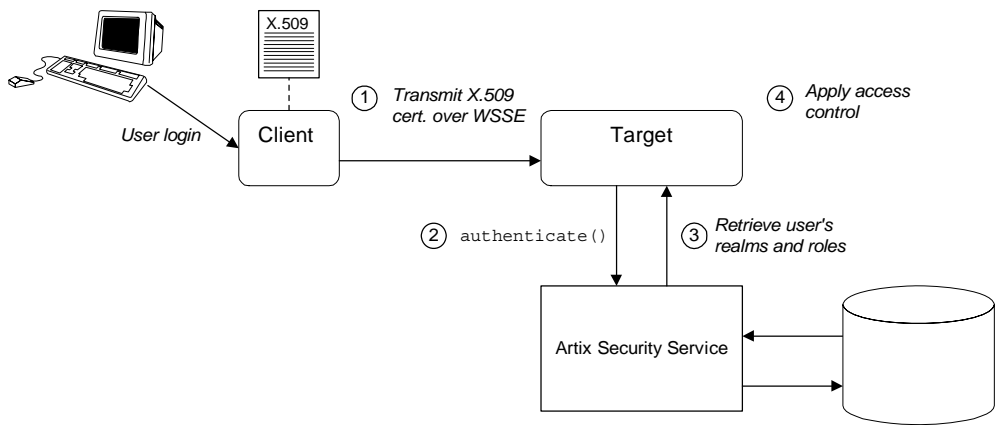

**Scenario description**

The scenario shown in [Figure 13](#) can be described as follows:

Stage	Description
1	When the client opens a connection to the server, the client sends an X.509 certificate in a WSSE SOAP header. The server checks the certificate as follows: <ul style="list-style-type: none"> <li>•</li> </ul>
2	The server performs security layer authentication by calling <code>authenticate()</code> on the Artix security service, passing username and password arguments as follows: <ul style="list-style-type: none"> <li>• <i>Username</i>—obtained by extracting the common name (CN) from the client certificate's subject DN.</li> <li>• <i>Password</i>—obtained from the value of the <code>plugins:asp:default_password</code> configuration variable in the server's <code>artix.cfg</code> domain configuration.</li> </ul> <p><b>WARNING:</b> This step is <i>not</i> a true authentication step, because the password is cached on the server side. Effectively, this authentication is performed with a dummy password.</p>
3	If authentication is successful, the Artix security service returns the user's realms and roles.
4	The ASP security layer controls access to the target's WSDL operations by consulting an <i>action-role mapping file</i> to determine what the user is allowed to do.

**Credentials priority**

When performing authentication, the X.509 certificate credentials have a *lower* priority than that of the other SOAP credential types. For example, if both WSSE UsernameToken credentials and X.509 certificate credentials are available, the WSSE UsernameToken credentials take priority over the X.509 certificate and are used to perform authentication and authorization at the Artix security layer.

**Programming the client for WSSE certificate-based authentication**

On the client side, you need to insert an X.509 certificate into the WSSE SOAP header by programming the `bus-security` context (there is currently no configuration option for doing this). For details, see [“Propagating an X.509 Certificate” on page 370](#).

**Configuring the server for WSSE certificate-based authentication**

On the server side it is necessary to configure the ASP security layer by editing the `artix-secure.cfg` domain configuration file (in the `ArtixInstallDir/artix/Version/etc/domains` directory), as shown in [Example 17](#).

**Example 17: Configuration for WSSE Certificate-Based Authentication**

```
# Artix Configuration File
security_artix {
    ...
    demos
    {
        hello_world
        {
            plugins:artix_security:shlib_name =
1          "it_security_plugin";
            binding:artix:server_request_interceptor_list=
2          "security";
            binding:client_binding_list = ["OTS+POA_Coloc",
3          "POA_Coloc", "OTS+GIOP+IIOP", "GIOP+IIOP", "GIOP+IIOP_TLS"];
            orb_plugins = ["xmlfile_log_stream", ..., "at_http",
4          "artix_security", "https"];
            plugins:is2_authorization:action_role_mapping =
5          "file://ArtixInstallDir/artix/2.0/demos/secure_hello_world/ht
6          tp_soap/config/helloworld_action_role_mapping.xml";
            policies:asp:enable_authorization = "true";
7          plugins:asp:security_level = "REQUEST_LEVEL";
            plugins:asp:default_password = "CertPassword";
            plugins:asp:authentication_cache_size = "5";
            plugins:asp:authentication_cache_timeout = "10";
            ...
        };
    };
};
```

The preceding extract from the domain configuration can be explained as follows:

1. The Artix server request interceptor list must include the `security` interceptor, which provides part of the functionality for the Artix security layer.
2. The `orb_plugins` list should include the `artix_security` plug-in, which is responsible for enabling authentication and authorization.
3. The action-role mapping file is used to apply access control rules to the authenticated user. The file determines which actions (that is, WSDL operations) can be invoked by an authenticated user, on the basis of the roles assigned to that user.

See [“Managing Access Control Lists” on page 215](#) for more details.

4. `policies:asp:enable_authorization` variable must be set to `true` to enable authorization.
5. The `plugins:asp:security_level` configuration variable specifies whether the credentials are taken from a request-level header or from a transport-level header. By setting the security level to `REQUEST_LEVEL`, you indicate that the credentials are taken from a SOAP header (for example, WSSE X.509 certificate or WSSE UsernameToken credentials).

In the case of WSSE X.509 certificate-based authentication, the username is taken to be the common name (CN) from the client certificate's subject DN (for an explanation of X.509 certificate terminology, see [“ASN.1 and Distinguished Names” on page 517](#)).

6. When WSSE X.509 certificate-based authentication is used, a default password, `CertPassword`, must be supplied on the server side. This password is then used for authenticating with the Artix security service.
7. The next pair of configuration variables configure the ASP caching mechanism. For more details, see [“ASP configuration variables” on page 46](#).



# Security for CORBA Bindings

*Using IONA's modular ART technology, you make a CORBA binding secure by configuring it to load the relevant security plug-ins. This section describes how to load and configure security plug-ins to reach the appropriate level of security for applications with a CORBA binding.*

---

**In this chapter**

This chapter discusses the following topics:

<a href="#">Overview of CORBA Security</a>	<a href="#">page 82</a>
<a href="#">Securing IIOP Communications with SSL/TLS</a>	<a href="#">page 84</a>
<a href="#">Securing Two-Tier CORBA Systems with CSI</a>	<a href="#">page 90</a>
<a href="#">Securing Three-Tier CORBA Systems with CSI</a>	<a href="#">page 96</a>
<a href="#">X.509 Certificate-Based Authentication for CORBA Bindings</a>	<a href="#">page 102</a>

# Overview of CORBA Security

## Overview

There are three layers of security available for CORBA bindings: IIOP over SSL/TLS (IIOP/TLS), which provides secure communication between client and server; CSI, which provides a mechanism for propagating username/password credentials; and the GSP plug-in, which is concerned with higher-level security features such as authentication and authorization.

The following combinations are recommended:

- IIOP/TLS only—for a pure SSL/TLS security solution.
- IIOP/TLS, CSI, and GSP layers—for a highly scalable security solution, based on username/password client authentication.

## CORBA applications and the Artix security framework

Figure 14 shows the main features of a secure CORBA application in the context of the Artix security framework.

**Figure 14:** A Secure CORBA Application within the Artix Security Framework

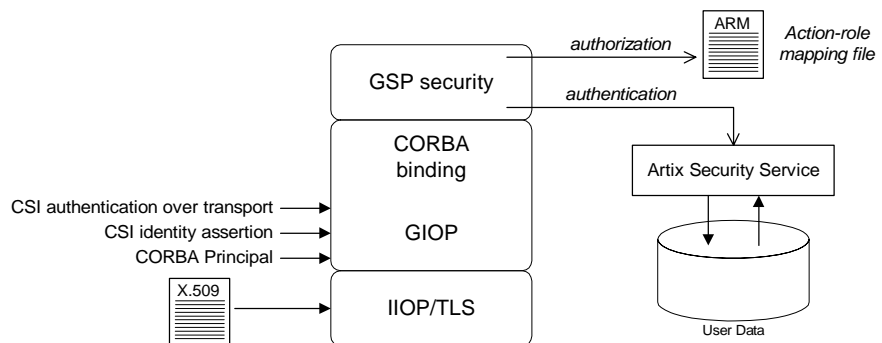



---

**Security plug-ins**

Within the Artix security framework, a CORBA application becomes fully secure by loading the following plug-ins:

- [IIOP/TLS plug-in](#)
- [CSlv2 plug-in](#)
- [GSP plug-in](#)

---

**IIOP/TLS plug-in**

The IIOP/TLS plug-in, `iiop_tls`, enables a CORBA application to transmit and receive IIOP requests over a secure SSL/TLS connection. This plug-in can be enabled independently of the other two plug-ins.

See [“Securing IIOP Communications with SSL/TLS” on page 84](#) for details on how to enable IIOP/TLS in a CORBA application.

---

**CSlv2 plug-in**

The CSlv2 plug-in, `csi`, provides a client authentication mechanism for CORBA applications. The authentication mechanism is based on a username and a password. When the CSlv2 plug-in is configured for use with the Artix security framework, the username and password are forwarded to a central Artix security service to be authenticated. This plug-in is needed to support the Artix security framework.

**Note:** The IIOP/TLS plug-in also provides a client authentication mechanism (based on SSL/TLS and X.509 certificates). The SSL/TLS and CSlv2 authentication mechanisms are independent of each other and can be used simultaneously.

---

**GSP plug-in**

The GSP plug-in, `gsp`, provides authorization by checking a user’s roles against the permissions stored in an action-role mapping file. This plug-in is needed to support the Artix security framework.

# Securing IIOP Communications with SSL/TLS

## Overview

This section describes how to configure a CORBA binding to use SSL/TLS security. In this section, it is assumed that your initial configuration comes from a secure location domain (that is, the `artix.cfg` domain configuration file has been modified to include `artix-secure.cfg`).

**WARNING:** The default certificates used in the CORBA configuration samples are for demonstration purposes only and are completely insecure. You must generate your own custom certificates for use in your own CORBA applications.

## Sample client configuration

For example, consider the configuration for a secure SSL/TLS client with no certificate. [Example 18](#) shows how to configure such a sample client.

### Example 18: Sample SSL/TLS Client Configuration

```
# Artix Configuration File
...
# General configuration at root scope.
...
my_secure_apps {
  # Common SSL/TLS configuration settings.
1  orb_plugins = ["local_log_stream", "iiop_profile", "giop",
  "iiop_tls"];
2
  binding:client_binding_list = ["GIOP+EGMIOP",
  "OTS+TLS_Coloc+POA_Coloc", "TLS_Coloc+POA_Coloc",
  "OTS+POA_Coloc", "POA_Coloc", "GIOP+SHMIOP",
  "CSI+OTS+GIOP+IIOP_TLS", "OTS+GIOP+IIOP_TLS",
  "CSI+GIOP+IIOP_TLS", "GIOP+IIOP_TLS", "CSI+OTS+GIOP+IIOP",
  "OTS+GIOP+IIOP", "CSI+GIOP+IIOP", "GIOP+IIOP"];
3
  policies:trusted_ca_list_policy =
  "ArtixInstallDir\artix\Version\demos\secure_hello_world\http
  soap\certificates\tls\x509\trusted_ca_lists\ca_list1.pem";
4
  policies:mechanism_policy:protocol_version = "SSL_V3";
  policies:mechanism_policy:ciphersuites =
  ["RSA_WITH_RC4_128_SHA", "RSA_WITH_RC4_128_MD5"];
}
```

**Example 18:** *Sample SSL/TLS Client Configuration*

```

5   event_log:filters = ["IT_ATLI_TLS=*", "IT_IIOP=*",
   "IT_IIOP_TLS=*", "IT_TLS=*"];
   ...
   my_client {
6       # Specific SSL/TLS client configuration settings
       principal_sponsor:use_principal_sponsor = "false";
7       policies:client_secure_invocation_policy:requires =
["Confidentiality", "Integrity", "DetectReplay",
"DetectMisordering", "EstablishTrustInTarget"];
       policies:client_secure_invocation_policy:supports =
["Confidentiality", "Integrity", "DetectReplay",
"DetectMisordering", "EstablishTrustInTarget"];
   };
};
...

```

The preceding client configuration can be described as follows:

1. Make sure that the `orb_plugins` variable in this configuration scope includes the `iiop_tls` plug-in.

**Note:** For fully secure applications, you should *exclude* the `iiop` plug-in (insecure IIOP) from the ORB plug-ins list. This renders the application incapable of making insecure IIOP connections.

For semi-secure applications, however, you should *include* the `iiop` plug-in before the `iiop_tls` plug-in in the ORB plug-ins list.

If you plan to use the full Artix Security Framework, you should include the `gsp` plug-in in the ORB plug-ins list as well—see [“Securing Two-Tier CORBA Systems with CSI” on page 90](#).

2. Make sure that the `binding:client_binding_list` variable includes bindings with the `IIOP_TLS` interceptor. You can use the value of the `binding:client_binding_list` shown here.
3. An SSL/TLS application needs a list of trusted CA certificates, which it uses to determine whether or not to trust certificates received from other SSL/TLS applications. You must, therefore, edit the

`policies:trusted_ca_list_policy` variable to point at a list of trusted certificate authority (CA) certificates. See [“Specifying Trusted CA Certificates” on page 267](#).

**Note:** If using Schannel as the underlying SSL/TLS toolkit (Windows only), the `policies:trusted_ca_list_policy` variable is ignored. Within Schannel, the trusted root CA certificates are obtained from the Windows certificate store.

4. The SSL/TLS mechanism policy specifies the default security protocol version and the available cipher suites—see [“Specifying Cipher Suites” on page 295](#).
5. This line enables console logging for security-related events, which is useful for debugging and testing. Because there is a performance penalty associated with this option, you might want to comment out or delete this line in a production system.
6. The SSL/TLS principal sponsor is a mechanism that can be used to specify an application’s own X.509 certificate. Because this client configuration does not use a certificate, the principal sponsor is disabled by setting `principal_sponsor:use_principal_sponsor` to `false`.
7. The following two lines set the *required* options and the *supported* options for the client secure invocation policy. In this example, the policy is set as follows:
  - ◆ Required options—the options shown here ensure that the client can open only secure SSL/TLS connections.
  - ◆ Supported options—the options shown include all of the association options, except for the `EstablishTrustInClient` option. The client cannot support `EstablishTrustInClient`, because it has no X.509 certificate.

### Sample server configuration

Generally speaking, it is rarely necessary to configure such a thing as a *pure server* (that is, a server that never makes any requests of its own). Most real servers are applications that act in both a server role and a client role.

Example 19 shows how to configure a sample server that acts both as a secure server and as a secure client.

### Example 19: Sample SSL/TLS Server Configuration

```

# Artix Configuration File
...
# General configuration at root scope.
...
my_secure_apps {
1   # Common SSL/TLS configuration settings.
    ...
    my_server {
2       # Specific SSL/TLS server configuration settings
        policies:target_secure_invocation_policy:requires =
["Confidentiality", "Integrity", "DetectReplay",
"DetectMisordering"];
        policies:target_secure_invocation_policy:supports =
["EstablishTrustInClient", "Confidentiality", "Integrity",
"DetectReplay", "DetectMisordering",
"EstablishTrustInTarget"];

3       principal_sponsor:use_principal_sponsor = "true";
4       principal_sponsor:auth_method_id = "pkcs12_file";
5       principal_sponsor:auth_method_data =
["filename=CertsDir\server_cert.p12"];

6       # Specific SSL/TLS client configuration settings
        policies:client_secure_invocation_policy:requires =
["Confidentiality", "Integrity", "DetectReplay",
"DetectMisordering", "EstablishTrustInTarget"];
        policies:client_secure_invocation_policy:supports =
["Confidentiality", "Integrity", "DetectReplay",
"DetectMisordering", "EstablishTrustInClient",
"EstablishTrustInTarget"];
    };
};
...

```

The preceding server configuration can be described as follows:

1. You can use the same common SSL/TLS settings here as described in the preceding [“Sample client configuration” on page 84](#)
2. The following two lines set the *required* options and the *supported* options for the target secure invocation policy. In this example, the policy is set as follows:

- ◆ Required options—the options shown here ensure that the server accepts only secure SSL/TLS connection attempts.
  - ◆ Supported options—all of the target association options are supported.
3. A server must always be associated with an X.509 certificate. Hence, this line enables the SSL/TLS principal sponsor, which specifies a certificate for the application.
  4. This line specifies that the X.509 certificate is contained in a PKCS#12 file. For alternative methods, see [“Specifying an Application’s Own Certificate” on page 268](#).
  5. Replace the X.509 certificate, by editing the `filename` option in the `principal_sponsor:auth_method_data` configuration variable to point at a custom X.509 certificate. The `filename` value should be initialized with the location of a certificate file in PKCS#12 format—see [“Specifying an Application’s Own Certificate” on page 268](#) for more details.  
For details of how to specify the certificate’s pass phrase, see [“Certificate Pass Phrase for HTTPS and IIOP/TLS” on page 270](#).
  6. The following two lines set the *required* options and the *supported* options for the client secure invocation policy. In this example, the policy is set as follows:
    - ◆ Required options—the options shown here ensure that the application can open only secure SSL/TLS connections to other servers.
    - ◆ Supported options—all of the client association options are supported. In particular, the `EstablishTrustInClient` option is supported when the application is in a client role, because the application has an X.509 certificate.

---

### Mixed security configurations

Most realistic secure server configurations are mixed in the sense that they include both server settings (for the server role), and client settings (for the client role). When combining server and client security settings for an application, you must ensure that the settings are consistent with each other.

For example, consider the case where the server settings are secure and the client settings are insecure. To configure this case, set up the server role as described in [“Sample server configuration” on page 86](#). Then configure the client role by adding (or modifying) the following lines to the `my_secure_apps.my_server` configuration scope:

```
orb_plugins = ["local_log_stream", "iiop_profile", "giop",
              "iiop", "iiop_tls"];
policies:client_secure_invocation_policy:requires =
  ["NoProtection"];
policies:client_secure_invocation_policy:supports =
  ["NoProtection"];
```

The first line sets the ORB plug-ins list to make sure that the `iiop` plug-in (enabling insecure IIOP) is included. The `NoProtection` association option, which appears in the required and supported client secure invocation policy, effectively disables security for the client role.

### Customizing SSL/TLS security policies

You can, optionally, customize the SSL/TLS security policies in various ways. For details, see the following references:

- [“Configuring HTTPS and IIOP/TLS Secure Associations” on page 279](#).
- [“Configuring HTTPS and IIOP/TLS Authentication” on page 259](#).

# Securing Two-Tier CORBA Systems with CSI

## Overview

This section describes how to secure a two-tier CORBA system using the OMG's Common Secure Interoperability specification version 2.0 (CSIv2). The client supplies username/password authentication data which is transmitted as CSI credentials and then authenticated on the server side. The following configurations are described in detail:

- [Client configuration.](#)
- [Target configuration.](#)

## Two-tier CORBA system

Figure 15 shows a basic two-tier CORBA system using CSI credentials, featuring a client and a target server.

**Figure 15:** Two-Tier CORBA System Using CSI Credentials

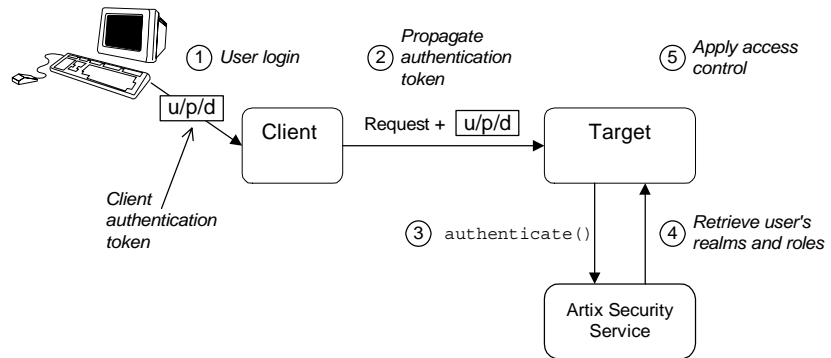



**Scenario description**

The scenario shown in [Figure 15](#) can be described as follows:

Stage	Description
1	The user enters a username, password, and domain name on the client side (user login). <b>Note:</b> The domain name must match the value of the <code>policies:csi:auth_over_transport:server_domain_name</code> configuration variable set on the server side.
2	When the client makes a remote invocation on the server, the CSI username/password/domain authentication data is transmitted to the target along with the invocation request.
3	The server authenticates the received username and password by calling out to the external Artix security service.
4	If authentication is successful, the Artix security service returns the user's realms and roles.
5	The GSP security layer controls access to the target's IDL interfaces by consulting an <i>action-role mapping file</i> to determine what the user is allowed to do.

**Client configuration**

The CORBA client from [Example 15 on page 90](#) can be configured as shown in [Example 20](#).

**Example 20: Configuration of a CORBA client Using CSI Credentials**

```

# Artix Configuration File
...
# General configuration at root scope.
...
1 my_secure_apps {
    # Common SSL/TLS configuration settings.
    ...
    # Common Artix security framework configuration settings.
2 orb_plugins = ["local_log_stream", "iiop_profile", "giop",
    "iiop_tls", "ots", "gsp"];

```

**Example 20:** Configuration of a CORBA client Using CSI Credentials

```

3 binding:client_binding_list = ["GIOP+EGMIOP",
    "OTS+TLS_Coloc+POA_Coloc", "TLS_Coloc+POA_Coloc",
    "OTS+POA_Coloc", "POA_Coloc", "GIOP+SHMIOP",
    "CSI+OTS+GIOP+IIOP_TLS", "OTS+GIOP+IIOP_TLS",
    "CSI+GIOP+IIOP_TLS", "GIOP+IIOP_TLS", "CSI+OTS+GIOP+IIOP",
    "OTS+GIOP+IIOP", "CSI+GIOP+IIOP", "GIOP+IIOP"];
4 binding:server_binding_list = ["CSI+GSP+OTS", "CSI+GSP",
    "CSI+OTS", "CSI"];
    ...
my_client {
5     # Specific SSL/TLS configuration settings.
    ...
6     # Specific Artix security framework settings.
    policies:csi:auth_over_transport:client_supports =
["EstablishTrustInClient"];
7
    principal_sponsor:csi:use_principal_sponsor = "true";
    principal_sponsor:csi:auth_method_id = "GSSUPMech";
    principal_sponsor:csi:auth_method_data = [];
    };
};
...

```

The preceding client configuration can be explained as follows:

1. The SSL/TLS configuration variables common to all of your applications can be placed here—see [“Securing IIOp Communications with SSL/TLS” on page 84](#) for details of the SSL/TLS configuration.
2. Make sure that the `orb_plugins` variable in this configuration scope includes both the `iiop_tls` and the `gsp` plug-ins in the order shown.
3. Make sure that the `binding:client_binding_list` variable includes bindings with the `CSI` interceptor. You can use the value of the `binding:client_binding_list` shown here.
4. Make sure that the `binding:server_binding_list` variable includes bindings with both the `CSI` and `GSP` interceptors. You can use the value of the `binding:server_binding_list` shown here.
5. The SSL/TLS configuration variables specific to the CORBA client can be placed here—see [“Securing IIOp Communications with SSL/TLS” on page 84](#).

6. This configuration setting specifies that the client supports sending username/password authentication data to a server.
7. The next three lines specify that the client uses the CSI principal sponsor to obtain the user's authentication data. With the configuration as shown, the user would be prompted to enter the username and password when the client application starts up.

## Target configuration

The CORBA target server from [Figure 15 on page 90](#) can be configured as shown in [Example 21](#).

### Example 21: Configuration of a Second-Tier Target Server in the Artix Security Framework

```
# Artix Configuration File
...
# General configuration at root scope.
...
my_secure_apps {
    # Common SSL/TLS configuration settings.
    ...
    # Common Artix security framework configuration settings.
    orb_plugins = [ ..., "iiop_tls", "gsp", ... ];
    binding:client_binding_list = [ ... ];
    binding:server_binding_list = [ ... ];
    ...
    my_two_tier_target {
1      # Specific SSL/TLS configuration settings.
        ...
        # Specific Artix security framework settings.
2      policies:csi:auth_over_transport:target_supports =
["EstablishTrustInClient"];
3      policies:csi:auth_over_transport:target_requires =
["EstablishTrustInClient"];
4      policies:csi:auth_over_transport:server_domain_name =
"CSIDomainName";

5      plugins:gsp:authorization_realm = "AuthzRealm";
6      plugins:is2_authorization:action_role_mapping =
"ActionRoleURL";
    }
}
```

**Example 21:** Configuration of a Second-Tier Target Server in the Artix Security Framework

```

7 # Artix security framework client configuration settings.
  policies:csi:auth_over_transport:client_supports =
    ["EstablishTrustInClient"];

    principal_sponsor:csi:use_principal_sponsor = "true";
    principal_sponsor:csi:auth_method_id = "GSSUPMech";
    principal_sponsor:csi:auth_method_data = [];
  };
};

```

The preceding target server configuration can be explained as follows:

1. The SSL/TLS configuration variables specific to the CORBA target server can be placed here—see [“Securing IIOB Communications with SSL/TLS” on page 84](#).
2. This configuration setting specifies that the target server *supports* receiving username/password authentication data from the client.
3. This configuration setting specifies that the target server *requires* the client to send username/password authentication data.
4. The `server_domain_name` configuration variable sets the server’s CSIV2 authentication domain name, `CSIDomainName`. The domain name embedded in a received CSIV2 credential must match the value of the `server_domain_name` variable on the server side.
5. This configuration setting specifies the Artix authorization realm, `AuthzRealm`, to which this server belongs. For more details about Artix authorization realms, see [“Artix Authorization Realms” on page 205](#).
6. The `action_role_mapping` configuration variable specifies the location of an action-role mapping that controls access to the IDL interfaces implemented by the server. The file location is specified in an URL format, for example:
 

```
file:///security_admin/action_role_mapping.xml (UNIX) or
file:///c:/security_admin/action_role_mapping.xml (Windows).
```

 For more details about the action-role mapping file, see [“ACL File Format” on page 217](#).

7. You should also set secure client configuration variables in the server configuration scope, because a secure server application usually behaves as a secure client of the core CORBA services. For example, almost all CORBA servers need to contact both the locator service and the CORBA naming service.
- 

#### **Related administration tasks**

After securing your CORBA applications with the Artix security framework, you might need to perform related administration tasks, for example:

- See [“Managing Users, Roles and Domains” on page 201](#).
- See [“ACL File Format” on page 217](#).

# Securing Three-Tier CORBA Systems with CSI

## Overview

This section describes how to secure a three-tier CORBA system using CSIv2. In this scenario there is a client, an intermediate server, and a target server. The intermediate server is configured to propagate the client identity when it invokes on the target server in the third tier. The following configurations are described in detail:

- [Intermediate configuration.](#)
- [Target configuration.](#)

## Three-tier CORBA system

Figure 16 shows a basic three-tier CORBA system using CSIv2, featuring a client, an intermediate server and a target server.

**Figure 16:** Three-Tier CORBA System Using CSIv2

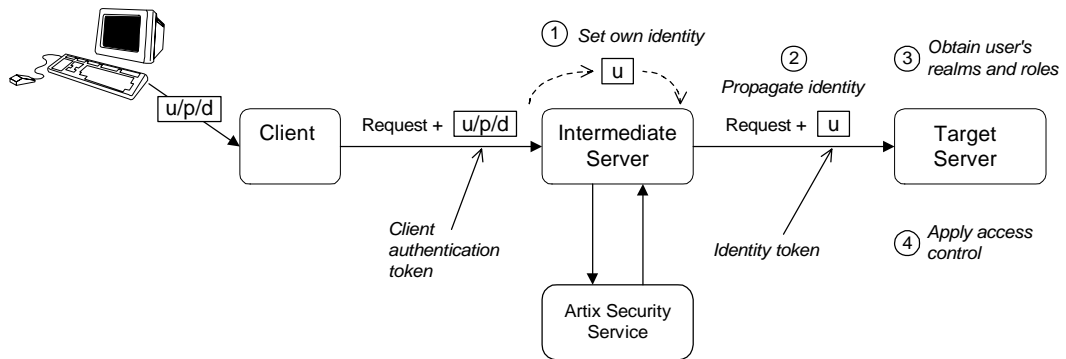

**Scenario description**

The second stage of the scenario shown in [Figure 16](#) (intermediate server invokes an operation on the target server) can be described as follows:

Stage	Description
1	The intermediate server sets its own identity by extracting the user identity from the received username/password CSI credentials. Hence, the intermediate server assumes the same identity as the client.
2	When the intermediate server makes a remote invocation on the target server, CSI identity assertion is used to transmit the user identity data to the target.
3	The target server then obtains the user's realms and roles.
4	The GSP security layer controls access to the target's IDL interfaces by consulting an <i>action-role mapping file</i> to determine what the user is allowed to do.

**Client configuration**

The client configuration for the three-tier scenario is identical to that of the two-tier scenario, as shown in ["Client configuration" on page 91](#).

**Intermediate configuration**

The CORBA intermediate server from [Figure 16 on page 96](#) can be configured as shown in [Example 22](#).

**Example 22:** *Configuration of a Second-Tier Intermediate Server in the Artix Security Framework*

```
# Artix Configuration File
...
# General configuration at root scope.
...
my_secure_apps {
    # Common SSL/TLS configuration settings.
    ...
    # Common Artix security framework configuration settings.
    orb_plugins = [ ..., "iiop_tls", "gsp", ... ];
    binding:client_binding_list = [ ... ];
    binding:server_binding_list = [ ... ];
    ...
}
```

**Example 22:** Configuration of a Second-Tier Intermediate Server in the Artix Security Framework

```

1   my_three_tier_intermediate {
      # Specific SSL/TLS configuration settings.
      ...
      # Specific Artix security framework settings.
2   policies:csi:attribute_service:client_supports =
      ["IdentityAssertion"];

3   policies:csi:auth_over_transport:target_supports =
      ["EstablishTrustInClient"];
4   policies:csi:auth_over_transport:target_requires =
      ["EstablishTrustInClient"];
5   policies:csi:auth_over_transport:server_domain_name =
      "CSIDomainName";

6   plugins:gsp:authorization_realm = "AuthzRealm";
7   plugins:is2_authorization:action_role_mapping =
      "ActionRoleURL";

8   # Artix security framework client configuration settings.
      policies:csi:auth_over_transport:client_supports =
      ["EstablishTrustInClient"];

      principal_sponsor:csi:use_principal_sponsor = "true";
      principal_sponsor:csi:auth_method_id = "GSSUPMech";
      principal_sponsor:csi:auth_method_data = [];
    };
};

```

The preceding intermediate server configuration can be explained as follows:

1. The SSL/TLS configuration variables specific to the CORBA intermediate server can be placed here—see [“Securing IIOP Communications with SSL/TLS” on page 84](#).
2. This configuration setting specifies that the intermediate server is capable of propagating the identity it receives from a client. In other words, the server is able to assume the identity of the client when invoking operations on third-tier servers.
3. This configuration setting specifies that the intermediate server *supports* receiving username/password authentication data from the client.



4. This configuration setting specifies that the intermediate server *requires* the client to send username/password authentication data.
5. The `server_domain_name` configuration variable sets the server's CSIV2 authentication domain name, `CSIDomainName`. The domain name embedded in a received CSIV2 credential must match the value of the `server_domain_name` variable on the server side.
6. This configuration setting specifies the Artix authorization realm, `AuthzRealm`, to which this server belongs. For more details about Artix authorization realms, see [“Artix Authorization Realms” on page 205](#).
7. This configuration setting specifies the location of an action-role mapping that controls access to the IDL interfaces implemented by the server. The file location is specified in an URL format, for example:  
`file:///security_admin/action_role_mapping.xml` (UNIX) or  
`file:///c:/security_admin/action_role_mapping.xml` (Windows).  
 For more details about the action-role mapping file, see [“ACL File Format” on page 217](#).
8. You should also set Artix security framework client configuration variables in the intermediate server configuration scope, because a secure server application usually behaves as a secure client of the core CORBA services. For example, almost all CORBA servers need to contact both the locator service and the CORBA naming service.

## Target configuration

The CORBA target server from [Figure 16 on page 96](#) can be configured as shown in [Example 23](#).

### Example 23: Configuration of a Third-Tier Target Server Using CSI

```
# Artix Configuration File
...
# General configuration at root scope.
...
my_secure_apps {
    # Common SSL/TLS configuration settings.
    ...
    # Common Artix security framework configuration settings.
    orb_plugins = [ ..., "iop_tls", "gsp", ... ];
    binding:client_binding_list = [ ... ];
    binding:server_binding_list = [ ... ];
    ...
}
```

**Example 23:** Configuration of a Third-Tier Target Server Using CSI

```

my_three_tier_target {
    # Specific SSL/TLS configuration settings.
    1     ...
    2     policies:iiop_tls:target_secure_invocation_policy:requires
= ["Confidentiality", "DetectMisordering", "DetectReplay",
"Integrity", "EstablishTrustInClient"];
    3     policies:iiop_tls:certificate_constraints_policy =
["ConstraintString1, ConstraintString2, ...];

    # Specific Artix security framework settings.
    4     policies:csi:attribute_service:target_supports =
["IdentityAssertion"];

    5     plugins:gsp:authorization_realm = "AuthzRealm";
    6     plugins:is2_authorization:action_role_mapping =
"ActionRoleURL";

    7     # Artix security framework client configuration settings.
    policies:csi:auth_over_transport:client_supports =
["EstablishTrustInClient"];

    principal_sponsor:csi:use_principal_sponsor = "true";
    principal_sponsor:csi:auth_method_id = "GSSUPMech";
    principal_sponsor:csi:auth_method_data = [];
};
};

```

The preceding target server configuration can be explained as follows:

1. The SSL/TLS configuration variables specific to the CORBA target server can be placed here—see [“Securing IIOP Communications with SSL/TLS” on page 84](#).
2. It is recommended that the target server require its *clients* to authenticate themselves using an X.509 certificate. For example, the intermediate server (acting as a client of the target) would then be required to send an X.509 certificate to the target during the SSL/TLS handshake.

You can specify this option by including the `EstablishTrustInClient` association option in the target secure invocation policy, as shown here (thereby overriding the policy value set in the outer configuration scope).

3. In addition to the preceding step, it is also advisable to restrict access to the target server by setting a certificate constraints policy, which allows access only to those clients whose X.509 certificates match one of the specified constraints—see [“Applying Constraints to Certificates” on page 276](#).

**Note:** The motivation for limiting access to the target server is that clients of the target server obtain a special type of privilege: propagated identities are granted access to the target server without the target server performing authentication on the propagated identities. Hence, the target server trusts the intermediate server to do the authentication on its behalf.

4. This configuration setting specifies that the target server supports receiving propagated user identities from the client.
5. This configuration setting specifies the Artix authorization realm, *AuthzRealm*, to which this server belongs. For more details about Artix authorization realms, see [“Artix Authorization Realms” on page 205](#).
6. This configuration setting specifies the location of an action-role mapping that controls access to the IDL interfaces implemented by the server. The file location is specified in an URL format, for example:
 

```
file:///security_admin/action_role_mapping.xml.
```

 For more details about the action-role mapping file, see [“ACL File Format” on page 217](#).
7. You should also set secure client configuration variables in the target server configuration scope, because a secure server application usually behaves as a secure client of the core CORBA services. For example, almost all CORBA servers need to contact both the locator service and the CORBA naming service.

---

### Related administration tasks

After securing your CORBA applications with the Artix security framework, you might need to perform related administration tasks, for example:

- See [“Managing Users, Roles and Domains” on page 201](#).
- See [“ACL File Format” on page 217](#).

---

# X.509 Certificate-Based Authentication for CORBA Bindings

---

## Overview

This section describes how to enable X.509 certificate authentication for CORBA bindings, based on a simple two-tier client/server scenario. In this scenario, the Artix security service authenticates the client's certificate and retrieves roles and realms based on the identity of the certificate subject. When certificate-based authentication is enabled, the X.509 certificate is effectively authenticated twice, as follows:

- *SSL/TLS-level authentication*—this authentication step occurs during the SSL/TLS handshake and is governed by Artix configuration settings and programmable SSL/TLS policies.
- *GSP security-level authentication and authorization*—this authentication step occurs after the SSL/TLS handshake and is performed by the Artix security service working in tandem with the `gsp` plug-in.

### Certificate-based authentication scenario

Figure 17 shows an example of a two-tier system, where authentication of the client's X.509 certificate is integrated with the Artix security service.

Figure 17: Overview of Certificate-Based Authentication

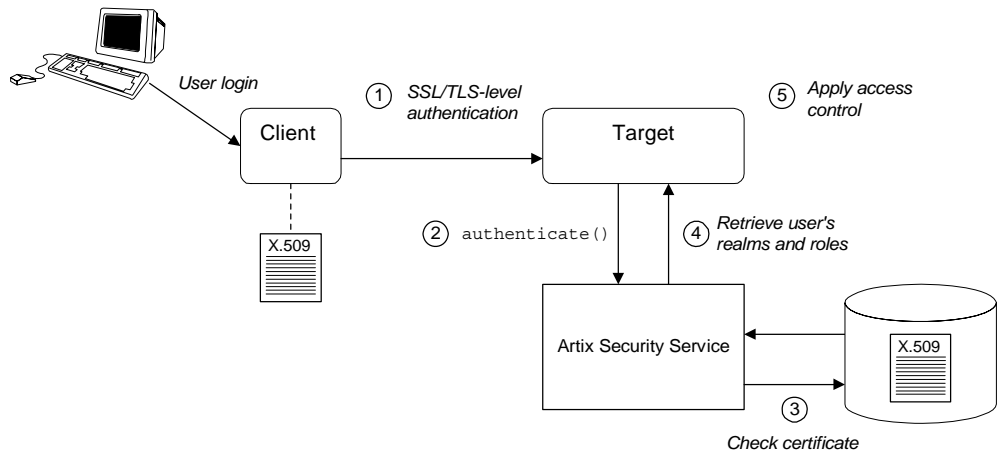

### Scenario description

The scenario shown in Figure 17 can be described as follows:

Stage	Description
1	<p>When the client opens a connection to the server, the client sends its X.509 certificate as part of the SSL/TLS handshake. The server then performs SSL/TLS-level authentication, checking the certificate as follows:</p> <ul style="list-style-type: none"> <li>• The certificate is checked against the server's <i>trusted CA list</i> to ensure that it is signed by a trusted certification authority.</li> <li>• If a certificate constraints policy is set, the certificate is checked to make sure it satisfies the specified constraints.</li> <li>• If a certificate validator policy is set (by programming), the certificate is also checked by this policy.</li> </ul>

Stage	Description
2	The server then performs security layer authentication by calling <code>authenticate()</code> on the Artix security service, passing the client's X.509 certificate as the argument.
3	The Artix security service authenticates the client's X.509 certificate by checking it against a cached copy of the certificate. The type of checking performed depends on the particular <i>third-party enterprise security service</i> that is plugged into the Artix security service.
4	If authentication is successful, the Artix security service returns the user's realms and roles.
5	The security layer controls access to the target's IDL interfaces by consulting an <i>action-role mapping file</i> to determine what the user is allowed to do.

## Client configuration

[Example 24](#) shows a sample client configuration that you can use for the security-level certificate-based authentication scenario ([Figure 17 on page 103](#)).

### Example 24: Client Configuration for Security-Level Certificate-Based Authentication

```
# Artix Configuration File
corba_cert_auth
{
    orb_plugins = ["local_log_stream", "iiop_profile", "giop",
                 "iiop_tls", "gsp"];

    event_log:filters = ["IT_GSP=*", "IT_CSI=*", "IT_TLS=*",
                       "IT_IIOP_TLS=*", "IT_ATLI2_TLS=*"];

    binding:client_binding_list = ["GIOP+EGMIOP",
                                   "OTS+POA_Coloc", "POA_Coloc", "OTS+TLS_Coloc+POA_Coloc",
                                   "TLS_Coloc+POA_Coloc", "GIOP+SHMIOP", "CSI+OTS+GIOP+IIOP",
                                   "CSI+GIOP+IIOP", "CSI+OTS+GIOP+IIOP_TLS",
                                   "CSI+GIOP+IIOP_TLS", "GIOP+IIOP", "GIOP+IIOP_TLS"];

    client_x509
    {
```

**Example 24:** *Client Configuration for Security-Level Certificate-Based Authentication*

```

policies:iiop_tls:client_secure_invocation_policy:supports =
["Integrity", "Confidentiality", "DetectReplay",
 "DetectMisordering", "EstablishTrustInTarget",
 "EstablishTrustInClient"];

policies:iiop_tls:client_secure_invocation_policy:requires =
["Integrity", "Confidentiality", "DetectReplay",
 "DetectMisordering"];

        principal_sponsor:use_principal_sponsor = "true";
        principal_sponsor:auth_method_id = "pkcs12_file";
        principal_sponsor:auth_method_data =
["filename=W:\art\etc\tls\x509\certs\demos\bob.p12",
 "password=bobpass"];
    };
};

```

The preceding client configuration is a typical SSL/TLS configuration. The only noteworthy feature is that the client must have an associated X.509 certificate. Hence, the `principal_sponsor` settings are initialized with the location of an X.509 certificate (provided in the form of a PKCS#12 file). For a discussion of these client SSL/TLS settings, see [“Sample client configuration” on page 84](#) and [“Deploying Application Certificates” on page 254](#).

**Target configuration**

[Example 25](#) shows a sample server configuration that you can use for the security-level certificate-based authentication scenario ([Figure 17 on page 103](#)).

**Example 25:** *Server Configuration for Security-Level Certificate-Based Authentication*

```

# Artix Configuration File
corba_cert_auth
{
    orb_plugins = ["local_log_stream", "iiop_profile", "giop",
 "iiop_tls", "gsp"];

    event_log:filters = ["IT_GSP=*", "IT_CSI=*", "IT_TLS=*",
 "IT_IIOP_TLS=*", "IT_ATLI2_TLS=*"];
}

```

**Example 25: Server Configuration for Security-Level Certificate-Based Authentication**

```

binding:client_binding_list = ["GIOP+EGMIOP",
"OTS+POA_Coloc", "POA_Coloc", "OTS+TLS_Coloc+POA_Coloc",
"TLS_Coloc+POA_Coloc", "GIOP+SHMIOP", "CSI+OTS+GIOP+IIOP",
"CSI+GIOP+IIOP", "CSI+OTS+GIOP+IIOP_TLS",
"CSI+GIOP+IIOP_TLS", "GIOP+IIOP", "GIOP+IIOP_TLS"];

server
{
    policies:csi:auth_over_transport:authentication_service
= "com.iona.corba.security.csi.AuthenticationService";

    principal_sponsor:use_principal_sponsor = "true";
    principal_sponsor:auth_method_id = "pkcs12_file";
1    principal_sponsor:auth_method_data =
["filename=CertDir\target_cert.pl2",
"password=TargetCertPass"];

    binding:server_binding_list = ["CSI+GSP", "CSI",
"GSP"];

    initial_references:IS2Authorization:plugin =
"it_is2_authorization";

    plugins:it_is2_authorization:ClassName =
"com.iona.corba.security.authorization.IS2AuthorizationPlugIn
";

2    plugins:is2_authorization:action_role_mapping =
"file:///PathToARMFile";

    auth_x509
3    {
plugins:gsp:enable_security_service_cert_authentication =
"true";

    policies:iiop_tls:target_secure_invocation_policy:supports =
["Integrity", "Confidentiality", "DetectReplay",
"DetectMisordering", "EstablishTrustInTarget",
"EstablishTrustInClient"];

```



**Example 25: Server Configuration for Security-Level Certificate-Based Authentication**

4

```

policies:iop_tls:target_secure_invocation_policy:requires =
["Integrity", "Confidentiality", "DetectReplay",
 "DetectMisordering", "EstablishTrustInClient"];
    };
};
};

```

The preceding server configuration can be explained as follows:

1. As is normal for an SSL/TLS server, you must provide the server with its own certificate, `target_cert.p12`. The simplest way to do this is to specify the location of a PKCS#12 file using the principal sponsor.
2. This configuration setting specifies the location of an action-role mapping file, which controls access to the server's interfaces and operations. See [“ACL File Format” on page 217](#) for more details.
3. The `plugins:gsp:enable_security_service_cert_authentication` variable is the key to enabling security-level certificate-based authentication. By setting this variable to `true`, you cause the server to perform certificate authentication in the GSP security layer.
4. The IIOPTLS target secure invocation policy must require `EstablishTrustInClient`. Evidently, if the client does not provide a certificate during the SSL/TLS handshake, there will be no certificate available to perform the security layer authentication.

**Related administration tasks**

When using X.509 certificate-based authentication for CORBA bindings, it is necessary to add the appropriate user data to your *enterprise security system* (which is integrated with the Artix security service through an iSF adapter), as follows:

- File adapter—see [“Certificate-based authentication for the file adapter” on page 212](#).
- LDAP adapter—see [“Certificate-based authentication for the LDAP adapter” on page 214](#).



# Single Sign-On

*Single sign-on (SSO) is an Artix security framework feature which is used to minimize the exposure of usernames and passwords to snooping. After initially signing on, a client communicates with other applications by passing an SSO token in place of the original username and password.*

**Note:** The SSO feature is unavailable in some editions of Artix. Please check the conditions of your Artix license to see whether your installation supports SSO.

## In this chapter

This chapter discusses the following topics:

<a href="#">SSO and the Login Service</a>	<a href="#">page 110</a>
<a href="#">Username/Password-Based SSO for SOAP Bindings</a>	<a href="#">page 113</a>
<a href="#">SSO Sample Configuration for SOAP Bindings</a>	<a href="#">page 119</a>

---

# SSO and the Login Service

---

## Overview

There are two different implementations of the login service, depending on the type of bindings you use in your application:

- [SOAP binding](#).
  - [CORBA Binding](#).
- 

## SOAP binding

For SOAP bindings, SSO is implemented by the following elements of the Artix security framework:

- *Artix login service*—a central service that authenticates username/password combinations and returns SSO tokens. Clients connect to this service using the HTTP/S protocol.
  - *login\_client plug-in*—the `login_client` plug-in, which is loaded by SOAP clients, is responsible for contacting the Artix login service to obtain an SSO token.
  - *artix\_security plug-in*—on the server side, the `artix_security` plug-in is responsible for parsing the received SSO credentials and authenticating the SSO token with the Artix security service.
- 

## CORBA Binding

For CORBA bindings, SSO is implemented by the following elements of the Artix security framework:

- *CORBA login service*—a central service that authenticates username/password combinations and generates SSO tokens. Clients connect to this service using the IIOP/TLS protocol.
- *GSP plug-in*—the generic security plug-in is responsible for the following:
  - ◆ On the client side—contacts the CORBA login service to obtain an SSO token.
  - ◆ On the server side—sends a received SSO token to be authenticated by the Artix security service.

## Advantages of SSO

SSO greatly increases the security of an Artix security framework system, offering the following advantages:

- Password visibility is restricted to the login service.
- Clients use SSO tokens to communicate with servers.
- Clients can be configured to use SSO with no code changes.
- SSO tokens are configured to expire after a specified length of time.
- When an SSO token expires, the Artix client automatically requests a new token from the login service. No additional user code is required.

## Login service

Figure 18 shows an overview of a login service. The client Bus automatically requests an SSO token by sending a username and a password to the login service. If the username and password are successfully authenticated, the login service returns an SSO token.

**Figure 18:** Client Requesting an SSO Token from the Login Service

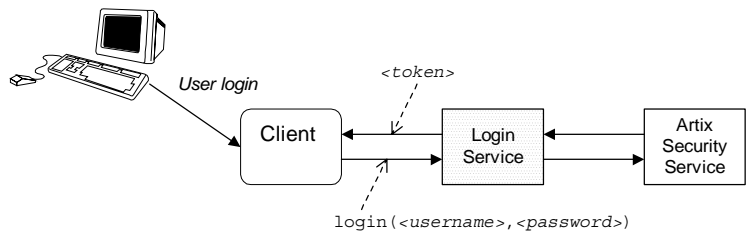

## SSO token

The SSO token is a compact key that the Artix security service uses to access a user's session details, which are stored in a cache.

---

**SSO token expiry**

The Artix security service is configured to impose the following kinds of timeout on an SSO token:

- *SSO session timeout*—this timeout places an absolute limit on the lifetime of an SSO token. When the timeout is exceeded, the token expires.
- *SSO session idle timeout*—this timeout places a limit on the amount of time that elapses between authentication requests involving the SSO token. If the central Artix security service receives no authentication requests in this time, the token expires.

For more details, see [“Configuring Single Sign-On Properties” on page 197](#).

---

**Automatic token refresh**

In theory, the expiry of SSO tokens could prove a nuisance to client applications, because servers will raise a security exception whenever an SSO token expires. In practice, however, when SSO is enabled, the relevant plug-in (`login_service` for SOAP and `gsp` for CORBA) catches the exception on the client side and contacts the login service again to refresh the SSO token automatically. The plug-in then automatically retries the failed operation invocation.

# Username/Password-Based SSO for SOAP Bindings

## Overview

When using SOAP bindings, usernames and passwords can be transmitted using one of the following mechanisms:

- WSSE UsernameToken.
- HTTP Basic Authentication.
- CORBA Principal (username only).

This section describes how to configure a client so that it transmits an SSO token in place of a username and a password.

## Username/password authentication without SSO

Figure 19 gives an overview of ordinary username/password-based authentication without SSO. In this case, the username, `<username>`, and password, `<password>`, are passed directly to the target server, which then contacts the Artix security service to authenticate the username/password combination.

**Figure 19:** Overview of Username/Password Authentication without SSO

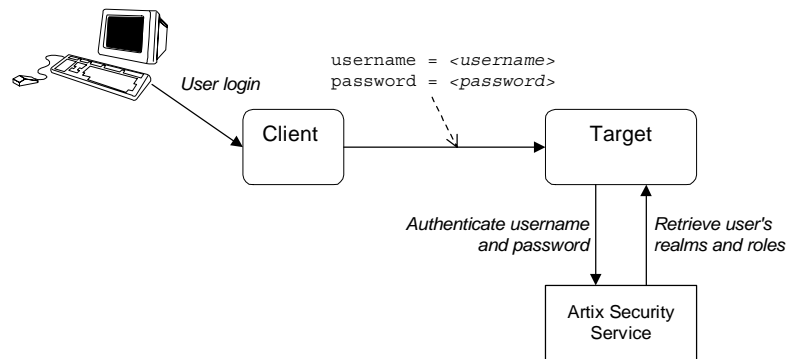

## Username/password authentication with SSO

Figure 20 gives an overview of username/password-based authentication when SSO is enabled.

**Figure 20:** Overview of Username/Password Authentication with SSO

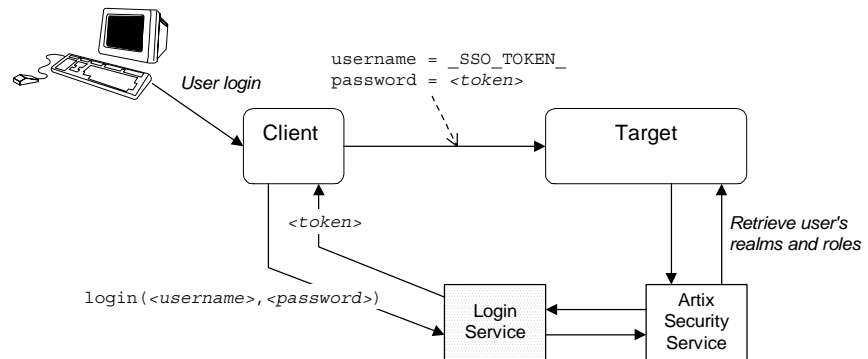

Prior to contacting the target server for the first time, the client Bus sends the username, `<username>`, and password, `<password>`, to the login server, getting an SSO token, `<token>`, in return. The client Bus then includes a IONA-proprietary SOAP header (extension of WSSE BinarySecurityToken) in the next request to the target server, sending the special string, `_SSO_TOKEN_`, instead of a username and the SSO token, `<token>`, instead of a password. The target server's Bus contacts the Artix security service to authenticate the username/password combination.

## Client configuration

Example 26 shows a typical domain configuration for an SSO SOAP client that employs username/password authentication.

**Example 26:** SOAP Client Configuration for Username/Password-Based SSO

```

# Artix Configuration File
...
1 plugins:login_client:wsl_url="../../wsl/login_service.wsl";
  plugins:login_client:shlib_name = "it_login_client";
...
  
```



**Example 26: SOAP Client Configuration for Username/Password-Based SSO**

```

2 sso_soap_client {
  orb_plugins = ["xmlfile_log_stream", "iiop_profile", "giop",
3   "iiop", "soap", "http", "login_client"];
  binding:artix:client_request_interceptor_list=
  "login_client";
  ...
};

```

The preceding Artix configuration can be described as follows:

1. The `plugins:login_client:wSDL_url` variable specifies the location of the Artix login service WSDL contract. You must edit this setting, if you store this contract at a different location.
2. The `orb_plugins` list must include the `login_client` plug-in.
3. The Artix client request interceptor list must include the `login_client` interceptor.

**Target configuration**

[Example 27](#) shows a typical domain configuration for an SSO SOAP target server that accepts connections from clients that authenticate themselves using username/password authentication.

**Example 27: SOAP Target Configuration for Username/Password-Based SSO**

```

# Artix Configuration File
...
sso_soap_target {
1   plugins:artix_security:shlib_name = "it_security_plugin";
  binding:artix:server_request_interceptor_list= "security";
  binding:client_binding_list = ["OTS+POA_Coloc", "POA_Coloc",
2   "OTS+GIOP+IIOP", "GIOP+IIOP", "GIOP+IIOP_TLS"];
  orb_plugins = ["xmlfile_log_stream", "iiop_profile", "giop",
  "iiop_tls", "soap", "http", "artix_security"];
3
  policies:asp:enable_authorization = "true";
  plugins:asp:authentication_cache_size = "5";
  plugins:asp:authentication_cache_timeout = "10";
  plugins:is2_authorization:action_role_mapping =
  "file://C:\artix_20\artix\2.0\demos\security\single_signon\et
4   c\helloworld_action_role_mapping.xml";
  plugins:asp:security_level = "REQUEST_LEVEL";

```

**Example 27: SOAP Target Configuration for Username/Password-Based SSO**

```
principal_sponsor:use_principal_sponsor = "true";
principal_sponsor:auth_method_id = "pkcs12_file";
principal_sponsor:auth_method_data =
["filename=%{PRIVATE_CERT_1}",
"password_file=%{PRIVATE_CERT_PASSWORD_FILE_1}"];
};
```

The preceding Artix configuration can be described as follows:

1. The `security` interceptor must appear in the Artix server interceptor list to enable the `artix_security` plug-in functionality.
2. The `orb_plugins` list must include the `artix_security` plug-in.
3. You can enable SSO with or without authentication. In this example, the authentication feature is enabled.
4. The security level is set to `REQUEST_LEVEL`, implying that the username and password are extracted from the SOAP header.

**Artix login service configuration**

[Example 28](#) shows the domain configuration for a standalone Artix login service. The clients of this login service authenticate themselves to the login service using WSE UsernameToken credentials.

**Example 28: Artix Login Service Domain Configuration**

```
# Artix Configuration File
...
sso_login_service {
  plugins:artix_security:shlib_name = "it_security_plugin";
  binding:artix:server_request_interceptor_list= "security";
  binding:client_binding_list = ["OTS+POA_Coloc", "POA_Coloc",
  "OTS+GIOP+IIOP", "GIOP+IIOP", "GIOP+IIOP_TLS"];
  orb_plugins = ["xmlfile_log_stream", "iiop_profile", "giop",
  "iiop_tls", "soap", "http", "artix_security",
  "login_service"];
  plugins:login_service:wSDL_url="../../wSDL/login_service.wSDL";
  plugins:login_service:shlib_name = "it_login_service";
  plugins:asp:security_level = "REQUEST_LEVEL";
};
```

The preceding Artix configuration can be described as follows:

1. The `security` interceptor must appear in the Artix server interceptor list to enable the `artix_security` plug-in functionality.
2. The `orb_plugins` list must include the `artix_security` plug-in and the `login_service` plug-in.
3. The `plugins:login_service:wSDL_url` variable specifies the location of the Artix login service WSDL contract. You must edit this setting, if you store this contract at a different location.
4. The security type setting selected here (`REQUEST_LEVEL`) implies that the login service reads the WSSE UsernameToken and PasswordToken credentials from the incoming client request messages.

You can change these settings to use different client credentials (for example, `MESSAGE_LEVEL` for HTTP Basic Authentication), but you must be careful to ensure that this matches the kind of credentials sent by the client.

### Login service WSDL configuration

[Example 29](#) shows an extract from the login service WSDL contract (in the directory, `artix/Version/demos/security/single_signon/wSDL`) showing details of the WSDL port settings.

#### Example 29: Extract from the Login Service WSDL Configuration

```
# Login Service WSDL Contract
<definitions ... >
  ...
  <service name="LoginService">
    <port binding="tns:LoginServiceBinding"
          name="LoginServicePort">
      <soap:address
        location="http://localhost:49675"/>
      <bus-security:security
        enableSSO="false"
        enableAuthorization="false"
        authenticationCacheSize="1"
        authenticationCacheTimeout="1" />
    </port>
  </service>
</definitions>
```

Note the following points about the WSDL port settings:

- The login service listens on a fixed host and port, `http://localhost:4975`. You will probably need to edit this setting before deploying the login service in a real system.  
However, you should *not* choose dynamic IP port allocation (for example, using `http://localhost:0`), because the clients would not be able to discover the value of the dynamically allocated port.
- You should not change the values of the attributes in the `<bus-security:security>` tag. The values shown in [Example 29](#) are essential for the correct functioning of the Artix login service.

**WARNING:** [Example 29](#) shows a login service configuration with insecure communications (HTTP). It is strongly recommended that you modify this configuration to use TLS security (HTTPS).

---

### Related administration tasks

For details of how to configure SSO token timeouts, see [“Configuring Single Sign-On Properties” on page 197](#).

---

# SSO Sample Configuration for SOAP Bindings

---

## Overview

This section provides SSO sample configurations for the SOAP binding including configurations for a client, a server, and a standalone Artix login service.

## Client SSO configuration

The `secure_artix.single_signon.client` configuration scope from [Example 30](#) can be used to configure a SOAP SSO client. This client configuration has the following characteristics:

- The SSO client loads the `login_client` plug-in, which is responsible for contacting the HTTP login server to obtain an SSO token.
- The client's SOAP and HTTP security settings are stored separately in the client's copy of the WSDL contract.

**WARNING:** It is strongly recommended that you configure the client's WSDL contract to use TLS security (HTTPS).

## Server SSO configuration

The `secure_artix.single_signon.server` configuration scope from [Example 30](#) can be used to configure a SOAP SSO server. This server configuration has the following characteristics:

- The SSO server loads the `artix_security` plug-in, which provides the implementation of SSO on the server side.
- You can enable authorization while using SSO credentials (set `policies:asp:enable_authorization` to `true`).

**WARNING:** It is strongly recommended that you configure the server's WSDL contract to use TLS security (HTTPS).

## Artix login service configuration

The `secure_artix.single_signon.sso_service` configuration scope from [Example 30](#) gives an example of a standalone Artix login service.

**WARNING:** It is strongly recommended that you configure the login server's WSDL contract to use TLS security (HTTPS).

**SSO configuration example**

[Example 30](#) shows sample configurations for a SOAP SSO client and a SOAP SSO server.

**Example 30: SOAP SSO Client and Server Configuration Examples**

```
secure_artix {
    ...
    single_signon
    {
        initial_references:IT_SecurityService:reference =
        "corbaloc:it_iiops:1.2@localhost:55349/IT_SecurityService";

        security_service
        {
            ...
        };

        client
        {
            plugins:login_client:wSDL_url="../../wSDL/login_service.wSDL";
            plugins:login_client:shlib_name = "it_login_client";
            binding:artix:client_request_interceptor_list=
            "login_client";
            orb_plugins = ["xmlfile_log_stream", "soap", "http",
            "login_client"];
        };

        server
        {
            plugins:artix_security:shlib_name =
            "it_security_plugin";
            binding:artix:server_request_interceptor_list=
            "security";
            binding:client_binding_list = ["OTS+POA_Coloc",
            "POA_Coloc", "OTS+GIOP+IIOP", "GIOP+IIOP", "GIOP+IIOP_TLS"];
            orb_plugins = ["xmlfile_log_stream", "iiop_profile",
            "giop", "iiop_tls", "soap", "http", "artix_security"];

            policies:asp:enable_authorization = "true";
            plugins:asp:authentication_cache_size = "5";
            plugins:asp:authentication_cache_timeout = "10";
            plugins:is2_authorization:action_role_mapping =
            "file://C:\artix_20\artix\2.0\demos\security\single_signon\et
            c\helloworld_action_role_mapping.xml";
            plugins:asp:security_level = "REQUEST_LEVEL";
            principal_sponsor:use_principal_sponsor = "true";
        };
    };
}
```

**Example 30: SOAP SSO Client and Server Configuration Examples**

```

        principal_sponsor:auth_method_id = "pkcs12_file";
        principal_sponsor:auth_method_data =
["filename=%{PRIVATE_CERT_1}",
"password_file=%{PRIVATE_CERT_PASSWORD_FILE_1}"];
    };

    sso_service
    {
        plugins:artix_security:shlib_name =
"it_security_plugin";
        binding:artix:server_request_interceptor_list=
"security";
        binding:client_binding_list = ["OTS+POA_Coloc",
"POA_Coloc", "OTS+GIOP+IIOP", "GIOP+IIOP", "GIOP+IIOP_TLS"];
        orb_plugins = ["xmlfile_log_stream", "iiop_profile",
"giop", "iiop_tls", "soap", "http", "artix_security",
"login_service"];

        plugins:login_service:wSDL_url="../../wSDL/login_service.wSDL";
        plugins:login_service:shlib_name = "it_login_service";
        plugins:asp:security_level = "REQUEST_LEVEL";
    };
};
...
};

```





# Publishing WSDL Securely

*The WSDL publishing service enables clients to download WSDL contracts that are constructed from a server's in-memory WSDL model. In order to ensure the integrity of the WSDL contracts downloaded in this manner, Artix supports a number of special security features.*

---

**In this chapter**

This chapter discusses the following topics:

<a href="#">Introduction to the WSDL Publish Plug-In</a>	<a href="#">page 124</a>
<a href="#">Deploying WSDL Publish in a Container</a>	<a href="#">page 127</a>
<a href="#">Preprocessing Published WSDL Contracts</a>	<a href="#">page 131</a>
<a href="#">Enabling SSL/TLS for WSDL Publish Plug-In</a>	<a href="#">page 132</a>

---

# Introduction to the WSDL Publish Plug-In

---

## Overview

The Artix WSDL publishing service is packaged as a plug-in and can be loaded by any Artix server that needs to make its WSDL contracts available to remote clients. In particular, the WSDL publish plug-in provides a way of publishing endpoint information for services that have dynamically allocated IP ports.

Figure 21 provides an overview of the endpoints that can be used to access the WSDL publishing service. Because published WSDL contracts are constructed from the server's in-memory WSDL model, they also include volatile information, such as dynamically-allocated IP ports.

**Figure 21:** *Endpoints Used by the WSDL Publishing Service*

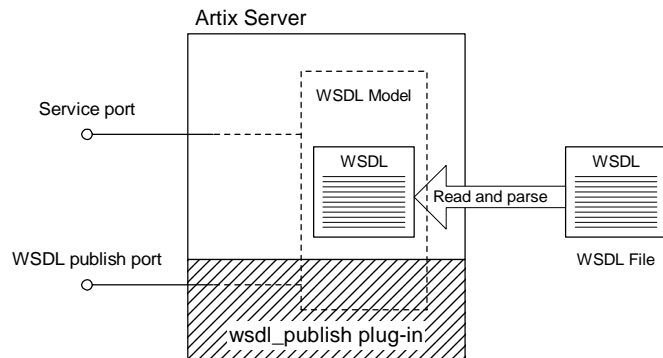

## Reference

For a detailed introduction to the Artix WSDL publishing service, see the relevant chapter in the *Deploying and Managing Artix Solutions* guide.

---

## Publishing WSDL

As shown in [Figure 21](#), the WSDL publishing service publishes WSDL contracts through two different kinds of endpoint, as follows:

- *Service-specific WSDL publish endpoints*—if the WSDL publish plug-in is enabled, the WSDL publishing service is automatically made available through any existing HTTP or HTTPS endpoints. In other words, the WSDL publishing service doubles up on existing service endpoints.
  - *Dedicated WSDL publish endpoint*—in addition to the service-specific endpoints, the WSDL publish plug-in opens its own dedicated IP port for publishing WSDL.
- 

## Security features

The WSDL publishing service has the following security features that provide protection for clients and servers:

- *Protection for clients*—there are two ways in which clients are protected:
  - ◆ *Secure connections to WSDL publish*—you can configure the WSDL publishing endpoints to be secured by SSL/TLS. This ensures that published WSDL contracts cannot be tampered with when they are retrieved by clients.
  - ◆ *Clients ignore downloaded client configuration*—some WSDL extensions allow you to configure client properties (for example, the location of a client's own X.509 certificate). Artix is designed to ignore client properties from downloaded WSDL contracts. Only local contracts can be used to configure the client.
- *Protection for servers*—some WSDL extensions might contain sensitive details about server configuration (for example, a server's private key password). To avoid exposing these details to clients, the WSDL publishing service automatically strips out server configuration details from the published WSDL contract.

---

**Loading the wsd\_publish plug-in**

To load the `wsdl_publish` plug-in, add `wsdl_publish` to your `orb_plugins` list in the application's configuration scope. For example, if your server's configuration scope is `secure_server`, you might use the following `orb_plugins` list:

```
# Artix Configuration file
secure_server
{
    orb_plugins = [ ... , "wsdl_publish"];
    ...
};
```

---

**Enabling the dedicated WSDL publish endpoint**

To specify the IP port for the dedicated WSDL publish endpoint, set the `plugins:wsdl_publish:publish_port` variable in the application's configuration scope.

For example, use the following configuration to specify that a server opens a dedicated WSDL publish endpoint on the IP port, 2222:

```
# Artix Configuration file
secure_server
{
    orb_plugins = [ ... , "wsdl_publish"];
    plugins:wsdl_publish:publish_port = "2222";
    ...
};
```

# Deploying WSDL Publish in a Container

## Overview

Figure 22 shows the outline of a container with a secure WSDL publish plug-in deployed inside it. There are three kinds of endpoints in this example: the container endpoint (which is used to administer the container), Artix service endpoints, and a dedicated endpoint for the WSDL publishing service.

**Figure 22:** *WSDL Publish Plug-In Deployed in a Secure Container*

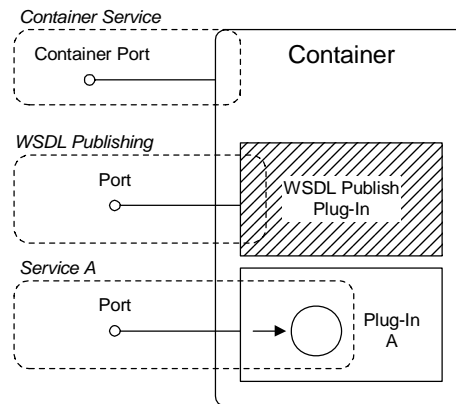

## Limitations of WSDL publish in a container

The WSDL publish plug-in is currently *not* compatible with running a container in mixed mode—that is, where some services are secure and other services insecure. When the WSDL publish plug-in is deployed in a container, every endpoint in the container must be secure. Specifically, the following endpoints must be secure:

- *WSDL publishing endpoint*—the dedicated WSDL publishing endpoint must be made secure by setting `plugins:wsl_publish:enable_secure_wsl_publish` to `true` and by setting `plugins:at_http:server:use_secure_sockets` to `true` (see “Configuring SSL/TLS for the WSDL publish endpoint” on page 133).

- *Container endpoint*—must be made secure by adding the appropriate settings to the Artix configuration file (see [“Configuring the secure container” on page 25](#)).
- *Artix service endpoints*—must be made secure, either by adding security settings to the Artix configuration file or to the service’s WSDL contract.

## How to deploy the WSDL publishing service

To deploy the WSDL publishing service into a secure container, modify the secure container configuration, as shown in the following example:

```
# Artix Configuration File
include "../../../../../etc/domains/artix.cfg";
include "../../../../../etc/domains/artix-secure.cfg";

secure_artix
{
    initial_references:IT_SecurityService:reference =
"corbaloc:it_iops:1.2@localhost:%{ISF_SECURE_PORT}/IT_SecurityService";

    secure_container
    {
        orb_plugins = [ ... , "wsdl_publish"];

        plugins:wsdl_publish:enable_secure_wsdl_publish = "true";
        plugins:at_http:server:use_secure_sockets = "true";
        ...
    };
};
```

Where `wsdl_publish` is added to the `orb_plugins` list to load the WSDL publish plug-in. The `plugins:wsdl_publish:enable_secure_wsdl_publish` variable is set to `true` to make the WSDL publishing port secure. The `plugins:at_http:server:use_secure_sockets` variable enables HTTPS on the WSDL publishing port (this is required, because the WSDL publishing service uses HTTP by default).

There is no need to set the `plugins:wsdl_publish:publish_port` variable here, because the WSDL publish port can be specified using the `-port` option on the `it_container` command instead.

**it\_container\_admin utility**

When connecting to a container with the `it_container_admin` utility, you cannot use the `-host` and `-port` options to specify the WSDL publishing service's address. The `-port` option can only be used to connect to an insecure HTTP container port.

To connect to a secure container using the `it_container_admin` utility, perform the following steps:

1. Add `bus_entity_resolver` to the list of ORB plug-ins in the configuration scope used by the `it_container_admin` utility. For example:

```
ContainerAdmin
{
  orb_plugins = ["xmlfile_log_stream", "https",
"bus_entity_resolver"];
  policies:https:trusted_ca_list_policy =
  "%{ROOT_TRUSTED_CA_LIST_POLICY_1}";

  bus:security:enable_security = "true";
};
```

This ensures that the `it_container_admin` utility is able to parse the HTTPS URL published by `it_container`.

2. Run the container with the command-line options shown in the following example:

```
it_container -ORBname Container -port 1234 -publish
-deploy DeployDescriptor.xml
```

Where `Container` is the name of the configuration scope for `it_container`. The `-port` option ensures that the container listens on a fixed IP port. The `-publish` option causes the container to write an endpoint reference to the file, `ContainerService.url`, in the current directory (you can optionally use the `-file` option to specify the file name explicitly). The `-deploy` option is used to deploy an Artix service plug-in whose deployment descriptor is `DeployDescriptor.xml`.

3. Run the `it_container_admin` utility, using the `-container` option to specify the location of the `ContainerService.url` file from the previous step, as follows:

```
it_container_admin -ORBname ContainerAdmin -container  
ContainerService.url CommandOption
```

Where *ContainerAdmin* is the name of the configuration scope for `it_container_admin`. The `ContainerService.url` file can be copied from the directory where it was generated by the container and *CommandOption* is one of the container administration commands (see *Configuring and Deploying Artix Solutions* details of available commands).



---

# Preprocessing Published WSDL Contracts

---

## Overview

If you configure a server's security through the WSDL contract (for example, by setting security attributes on the `bus-security:security` element), you could potentially expose sensitive information to clients through the WSDL publishing mechanism.

To avoid opening a potential security hole, the `wSDL_publish` plug-in provides a preprocessing option to strip out server settings before publishing the WSDL contract. This option is enabled by default.

---

## Specifying WSDL preprocessing

You can use the `plugins:wSDL_publish:processor` variable to specify the kind of preprocessing done before publishing a WSDL contract.

Because published contracts are intended for client consumption, by default, all server-side WSDL artifacts are removed from the published contract. You can also require IONA-specific extensors to be removed. This variable has the following possible values:

<code>artix</code>	Remove server-side artifacts. This is the default setting.
<code>standard</code>	Remove server-side artifacts and IONA proprietary extensors.
<code>none</code>	Disable preprocessing

---

## Example configuration

[Example 31](#) shows a sample configuration for a secure server that selects the `standard` processing option for publishing WSDL contracts. This option ensures that all server related configuration and Artix specific tags are stripped from the WSDL contracts before publishing.

### Example 31: Configuration for Preprocessing Published WSDL Contracts

```
# Artix Configuration file
secure_server
{
    orb_plugins = [ ... , "wSDL_publish"];

    plugins:wSDL_publish:publish_port = "2222";
    plugins:wSDL_publish:processor = "standard";
    ...
};
```

---

# Enabling SSL/TLS for WSDL Publish Plug-In

---

## Overview

This section describes how to make the WSDL publishing service secure, by requiring clients to connect using the SSL/TLS protocol. The purpose of this feature is to protect clients from downloading WSDL contracts that have been tampered with. Without this security, a malicious user could intercept and modify the WSDL contract as it is being downloaded to the client.

---

## Securing import statements

If you are about to enable SSL/TLS for the WSDL publishing service, you should ensure that `wSDL:import` statements in your WSDL contracts locate imported contracts using a `https` URL instead of a `http` URL.

For example, if your contract includes a statement that imports the WS-Addressing schema, as follows:

```
<import namespace="http://www.w3.org/2005/08/addressing"
  schemaLocation="http://www.w3.org/2005/08/addressing/ws-addr.xsd" />
```

You would modify this import statement, changing the `schemaLocation` attribute to use a `https` URL, as follows:

```
<import namespace="http://www.w3.org/2005/08/addressing"
  schemaLocation="https://www.w3.org/2005/08/addressing/ws-addr.xsd" />
```

In addition, if any of the imported WSDL contracts themselves contain import statements, these recursive import statements must also be modified to use a `https` URL.

---

## Configuring SSL/TLS for a service-specific endpoint

If you configure an Artix service to use HTTPS, the `wSDL_publish` plug-in automatically makes the publishing service available through the same HTTPS endpoint. Because the publishing service is exposed through the same IP port as your Artix service, any security policies and settings that apply to the service endpoint automatically apply to connections made for the purpose of downloading WSDL contracts. Hence, you can make this publishing mechanism secure simply by configuring your service endpoints to be secure.

For details of how to secure service endpoints with HTTPS, see [“Securing HTTP Communications with SSL/TLS” on page 51](#).

**Note:** Publishing WSDL through a service-specific endpoint is only possible, if the service runs over the HTTPS transport. Other transports are not supported.

## Configuring SSL/TLS for the WSDL publish endpoint

The WSDL publish plug-in also provides a dedicated HTTP port for publishing WSDL contracts. To make this port secure, you must explicitly enable security by setting the `plugins:wSDL_publish:enable_secure_wSDL_publish` configuration variable to `true` and the `plugins:at_http:server:use_secure_sockets` variable to `true`. To associate an X.509 certificate with this port, you can use the same configuration options as you would for a regular Artix endpoint (see [“Deploying Application Certificates” on page 254](#)).

[Example 32](#) shows a sample configuration of a secure WSDL publish endpoint that uses the HTTPS principal sponsor to specify an own certificate, `CertName.p12`.

### Example 32: Configuration for Secure WSDL Publish Endpoint

```
# Artix Configuration File
secure_server
{
    orb_plugins = [ ... , "wSDL_publish", "at_http", "https"];

    plugins:wSDL_publish:publish_port = "2222";
    plugins:wSDL_publish:enable_secure_wSDL_publish = "true";
    plugins:at_http:server:use_secure_sockets = "true";

    policies:target_secure_invocation_policy:requires =
["Confidentiality", "Integrity", "DetectReplay",
"DetectMisordering"];
    policies:target_secure_invocation_policy:supports =
["Confidentiality", "EstablishTrustInTarget",
"EstablishTrustInClient", "DetectMisordering",
"DetectReplay", "Integrity"];

    policies:https:trusted_ca_list_policy
="X509Deploy/ca/CACert.pem";

    principal_sponsor:https:use_principal_sponsor = "true";
}
```

**Example 32:** Configuration for Secure WSDL Publish Endpoint

```
principal_sponsor:https:auth_method_id = "pkcs12_file";
principal_sponsor:https:auth_method_data =
["filename=X509Deploy/certs/applications/CertName.p12"];
...
};
```

**Testing secure WSDL publishing**

To test the secure WSDL publishing service, you can try to connect to the service using an ordinary Web browser, as follows:

1. Configure your Artix server to enable secure WSDL publishing, as shown in [Example 32 on page 133](#). In this example, the server will open a dedicated WSDL publishing port at IP port 2222.
2. If your server requires mutual authentication (that is, requiring clients to send an X.509 certificate to the server), you must add a personal X.509 certificate to the Web browser's certificate store. The certificate must be signed by a CA that the server trusts.

For example, to install a personal X.509 certificate into Internet Explorer, do the following:

- i. Select **Tools | Internet Options** to open the **Internet Options** dialog.
- ii. Click the **Content** tab and then click the **Certificates** button. The **Certificates** dialog opens.
- iii. Click the **Personal** tab and then click the **Import** button to bring up the **Certificate Import Wizard**.
- iv. Follow the instructions in the **Certificate Import Wizard** to import a PKCS#12 format certificate (or other supported format) into the Internet Explorer certificate store.

**Note:** At the end of the import process, if the PKCS#12 certificate includes a CA certificate in its certificate chain, the import wizard will ask you whether you want to install that CA certificate as a trusted CA certificate.

3. Optionally, install the CA certificate that signed the server's certificates into the Web browser's certificate store.

If you do not install the CA certificate, you can still run the test. However, in this case, when you attempt to connect to the server, your Web browser will warn you that the server's certificate is not trusted.

4. Start the Artix server.
5. Connect to the server's WSDL publish port using the Web browser. In the Web browser, enter the following secure URL address:

```
https://ServerHost:2222/get_wsdl?
```

Where *ServerHost* is the name of the host where the server is running (or `localhost`, if this is the same host where you are running the Web browser). After connecting to the WSDL publish port, you should see a page like the following:

**Figure 23:** HTML Page Served Up by the WSDL Publishing Service



6. You can also try a negative test—entering the URL address, `http://ServerHost:2222/get_wsdl?` into the browser—to verify that the WSDL publish port rejects insecure HTTP connections.



# Configuring the Artix Security Plug-In

*Artix allows you to configure a number of security features directly from the Artix contract describing your system.*

---

**In this chapter**

This chapter discusses the following topics:

<a href="#">The Artix Security Plug-In</a>	<a href="#">page 138</a>
<a href="#">Configuring an Artix Configuration File</a>	<a href="#">page 139</a>
<a href="#">Configuring a WSDL Contract</a>	<a href="#">page 141</a>

---

# The Artix Security Plug-In

---

## Overview

This section describes how to initialize the Artix security plug-in, which is responsible for performing authentication and authorization for non-CORBA bindings (CORBA bindings use the `gsp` plug-in).

The Artix security plug-in implements only a part of Artix security. Specifically, it is *not* responsible for transmitting credentials, nor does it implement any cryptographic algorithms.

---

## Load the `artix_security` plug-in

To load the Artix security plug-in, you must include `artix_security` in the `orb_plugins` list in your application's configuration scope.

Edit your application's configuration scope in the `artix-secure.cfg` file so that it includes the following configuration settings:

```
# Artix Configuration File
...
orb_plugins = ["xmlfile_log_stream", "iiop_profile", "giop",
              "iiop_tls", "soap", "at_http", "artix_security", "https"];

plugins:artix_security:shlib_name = "it_security_plugin";
binding:artix:server_request_interceptor_list = "security";
```

The `orb_plugins` list for your application might differ from the one shown here, but it should include the `artix_security` entry.

---

## Enable the `artix_security` plug-in

The `artix_security` plug-in is enabled by default, once it is loaded into your application. You might like to check, however, that the plug-in is not accidentally disabled, as follows:

- If the `policies:asp:enable_security` variable is present in your application's configuration (or an enclosing configuration scope), it should be set to `true`.
- If the `enableSecurity` attribute appears in a `<bus-security:security>` tag in your WSDL contract, it should be set to `true`.



# Configuring an Artix Configuration File

## Overview

You can tailor the behavior of the Artix security plug-in by setting configuration variables in the Artix configuration file, `artix.cfg`, as described here. The settings in the configuration file are applied, by default, to all the services and ports in your WSDL contract.

## Prerequisites

Before configuring the Artix security plug-in, you must ensure that the plug-in is loaded into your application. See [“Load the artix\\_security plug-in” on page 138](#).

## Artix security plug-in configuration variables

The complete set of Artix security plug-in variables, which are all optional, are listed and described in [Table 1](#). These settings are applied by default to all services and ports in the WSDL contract.

**Table 1:** *The Artix Security Plug-In Configuration Variables*

Configuration Variable	Description
<code>policies:asp:enable_security</code>	A boolean variable that enables the <code>artix_security</code> plug-in. When <code>true</code> , the plug-in is enabled; when <code>false</code> , the plug-in is disabled. Default is <code>true</code> . <b>Note:</b> You can override this setting in the WSDL contract. See <a href="#">“Configuring a WSDL Contract” on page 141</a> .
<code>plugins:is2_authorization:action_role_mapping</code>	A variable that specifies the action-role mapping file URL.
<code>policies:asp:enable_authorization</code>	A boolean variable that specifies whether Artix should enable authorization using the Artix Security Framework. Default is <code>false</code> .
<code>plugins:asp:authentication_cache_size</code>	The maximum number of credentials stored in the authentication cache. If exceeded, the oldest credential in the cache is removed. A value of -1 (the default) means unlimited size. A value of 0 means disable the cache.

**Table 1:** *The Artix Security Plug-In Configuration Variables*

Configuration Variable	Description
<code>plugins:asp:authentication_cache_timeout</code>	<p>The time (in seconds) after which a credential is considered stale. Stale credentials are removed from the cache and the server must re-authenticate with the Artix security service on the next call from that user.</p> <p>A value of -1 (the default) means an infinite time-out. A value of 0 means disable the cache.</p>
<code>plugins:asp:security_level</code>	<p>This variable specifies the level from which security credentials are picked up. For a detailed description of the allowed values, see <a href="#">plugins:asp:security_level</a>.</p>
<code>plugins:asp:authorization_realm</code>	<p>This variable specifies the Artix authorization realm to which an Artix server belongs. The value of this variable determines which of a user's roles are considered when making an access control decision.</p>
<code>plugins:asp:default_password</code>	<p>This variable specifies the password to use on the server side when the <code>securityType</code> attribute is set to either <code>PRINCIPAL</code> or <code>CERT_SUBJECT</code>.</p>
<code>plugins:asp:enable_security_service_load_balancing</code>	<p>This boolean variable enables load balancing over a cluster of Artix security services. For details of how to enable security service clustering, see <a href="#">"Clustering and Federation" on page 179</a>.</p>
<code>plugins:asp:enable_security_service_cert_authentication</code>	<p>This boolean variable enables authentication based on the client certificate extracted from the TLS security layer. For details of how to enable this kind of authentication, see <a href="#">"X.509 Certificate-Based Authentication" on page 66</a>.</p>

# Configuring a WSDL Contract

## Overview

Occasionally you will need finer grained control of your system's security than is provided through the standard Artix and security configuration. Artix provides the ability to control security on a per-port basis by describing the service's security settings in the Artix contract that describes it. This is done by using the `<bus-security:security>` extension in the `port` element describing the service's address and transport details.

## Namespace

The XML namespace defining `<bus-security:security>` is `http://schemas.iona.com/bus`. You need to add the following line to the `definitions` element of any contracts that use the `bus-security:security` element:

```
xmlns:bus-security="http://schemas.iona.com/bus/security"
```

## `<bus-security:security>` attributes

The complete set of `<bus-security:security>` attributes, which are all optional, are listed [Table 2](#). Each attribute maps to an equivalent configuration variable, as shown in the table. The attributes specified in the WSDL contract override settings specified in the Artix configuration file, `artix-secure.cfg`.

**Table 2:** `<bus-security:security>` Attributes

<code>&lt;bus-security:security&gt;</code> Attribute	Equivalent Configuration Variable
<code>enableSecurity</code>	<code>policies:asp:enable_security</code>
<code>is2AuthorizationActionRoleMapping</code>	<code>plugins:is2_authorization:action_role_mapping</code>
<code>enableAuthorization</code>	<code>policies:asp:enable_authorization</code>
<code>authenticationCacheSize</code>	<code>plugins:asp:authentication_cache_size</code>
<code>authenticationCacheTimeout</code>	<code>plugins:asp:authentication_cache_timeout</code>
<code>securityType</code>	<code>plugins:asp:security_type</code> ( <i>Obsolete</i> )
<code>securityLevel</code>	<code>plugins:asp:security_level</code>

**Table 2:** *<bus-security:security> Attributes*

<b>&lt;bus-security:security&gt; Attribute</b>	<b>Equivalent Configuration Variable</b>
authorizationRealm	<code>plugins:asp:authorization_realm</code>
defaultPassword	<code>plugins:asp:default_password</code>

**Enabling security for a service**

[Example 33](#) shows how to enable security for the service `personalInfoService`.

**Example 33:** *Enabling Security in an Artix Contract*

```
<definitions ...
  xmlns:bus-security="http://schemas.iona.com/bus/security"
  ...>
...
<service name="personalInfoService">
  <port name="personalInfoServicePort" binding="tns:infoSOAPBinding">
    <soap:address location="http://localhost:8080"/>
    <bus-security:security enableSecurity="true"
      is2AuthorizationActionRoleMapping="file://c:/iona/artix/2.0/bin/action_role.xml"
      enableAuthorization="true"
      securityLevel="REQUEST_LEVEL"
      authenticationCacheSize="5"
      authenticationCacheTimeout="10" />
  </port>
</service>
</definitions>
```

The `bus-security:security` element in [Example 33](#) configures `personalInfoService` to use WS Security compliant username/password authentication.

**Disabling security for a service**

[Example 34](#) shows how to selectively disable security for the service `widgetService`.

**Example 34:** *Disabling Security in an Artix Contract*

```
<definitions ...
  xmlns:bus-security="http://schemas.ionas.com/bus/security"
  ...>
...
<service name="widgetService">
  <port name="widgetServicePort" binding="tns:widgetSOAPBinding">
    <soap:address location="http://localhost:8080"/>
    <bus-security:security enableSecurity="false" />
  </port>
</service>
</definitions>
```



# Configuring the Artix Security Service

*This chapter describes how to configure the properties of the Artix security service and, in particular, how to configure a variety of adapters that can integrate the Artix security service with third-party enterprise security back-ends (for example, LDAP).*

---

**In this chapter**

This chapter discusses the following topics:

<a href="#">Configuring the Security Service</a>	<a href="#">page 146</a>
<a href="#">Configuring the File Adapter</a>	<a href="#">page 167</a>
<a href="#">Configuring the LDAP Adapter</a>	<a href="#">page 169</a>
<a href="#">Configuring the Kerberos Adapter</a>	<a href="#">page 175</a>
<a href="#">Clustering and Federation</a>	<a href="#">page 179</a>
<a href="#">Additional Security Configuration</a>	<a href="#">page 196</a>

---

# Configuring the Security Service

## Overview

---

To configure the basic properties of the Artix security service, you must edit the appropriate settings in the Artix configuration file. In particular, the settings in the Artix configuration file enable you to specify the manner in which the security service communicates with other Artix programs.

Two major variants of security service communications are supported: IIOp/TLS-based and HTTPS-based.

## In this section

---

This section contains the following subsections:

<a href="#">Security Service Accessible through IIOp/TLS</a>	<a href="#">page 147</a>
<a href="#">Security Service Accessible through HTTPS</a>	<a href="#">page 156</a>



---

## Security Service Accessible through IIOP/TLS

---

### Overview

This section describes how to configure a security service that is made accessible through the IIOP/TLS protocol. This approach to configuring the security service has been used by all versions of Artix that include security, up to and including 4.0.

---

### Setting the security service's host and port

To change the security service's host and port, edit the configuration as follows:

- *Configuration of the security service*—in the security service's configuration scope, specify the host and port as follows:

```
# Artix Configuration File
plugins:security:iiop_tls:host = "SecurityHost";
plugins:security:iiop_tls:port = "SecurityPort";
```

Where *SecurityHost* and *SecurityPort* specify the host and IP port where the security service listens for IIOP/TLS connections.

- *Configuration of clients of the security service*—for any programs that need to contact the security service, add the following line to their configuration scopes (or enclosing scopes):

```
# Artix Configuration File
corbaloc:it_iiops:1.2@SecurityHost:SecurityPort/IT_Security
Service
```

Where you must replace the *SecurityHost* and *SecurityPort* settings in the *it\_iiops* address.

---

### Replacing X.509 certificates

The security service is provided with demonstration X.509 certificates by default. Whilst this is convenient for running demonstrations and tests, it is fundamentally insecure, because Artix provides identical demonstration certificates for every installation.

Before deploying the security service in a live system, therefore, you *must* replace the default X.509 certificates with your own custom-generated certificates. Specifically, for the security service you must replace the following certificates:

- *Trusted CA list*—this is a list of trusted Certification Authority (CA) certificates, which is used to vet certificates presented by clients. Only certificates signed by one of the CAs on the trusted list will be allowed to connect to the security service.

To update the trusted CA list, edit the

`policies:trusted_ca_list_policy` variable in the security service's configuration scope (or enclosing scope). For more details, see [“Deploying Trusted Certificate Authority Certificates” on page 248](#).

- *Security service's own certificate*—the security service uses its own X.509 certificate to identify itself to peers during SSL/TLS handshakes.

To replace the security service's own certificate, edit the principal sponsor settings in the security service's configuration scope (or enclosing scope). For more details, see [“Deploying Application Certificates” on page 254](#).

## Setting client certificate constraints

To provide a basic level of access control, the security service enables you to set client certificate constraints, which prevents clients from opening a connection to the security service unless they present a certificate that matches the specified constraints.

To specify the security service's client certificate constraints, assign the constraints to the

`policies:security_server:client_certificate_constraints` configuration variable (for details of how to specify constraints, see [“Applying Constraints to Certificates” on page 401](#)).

**Note:** You should specify the security service's constraints using the `policies:security_server:client_certificate_constraints` constraints variable rather than the generic `policies:certificate_constraints_policy` constraints variable. This approach allows you to differentiate between the constraints on the security service and the constraints on other services that might run in the same process (for example, the login service).

---

**Minimum level of security**

The security service *always* requires clients to present an X.509 certificate to identify themselves, irrespective of the secure invocation policy specified in configuration. Hence, the actual level of security that applies to SSL/TLS communications is obtained by implicitly adding `EstablishTrustInClient` to the list of required association options in the target secure invocation policy (the security service does this automatically).

---

**Relocating files**

The security service depends on several directories and files, which might need to be relocated when it comes to deployment time. Some directories and files that might be relocated are, as follows:

- *Artix install directory*—if you manually move the core files in the Artix installation, this would affect the location of certain library directories that the security service depends on. The following configuration settings would be affected:
  - ♦ `SECURITY_CLASSPATH`—a substitution variable that specifies the location of the JAR file containing the security service code.
  - ♦ `plugins:java_server:system_properties`—amongst this list of properties, the `java.endorsed.dirs` property would be affected.
- *iS2 properties file*—this is an important file that provides additional security service configuration through Java properties. You can alter the location of this file by editing the `is2.properties` property in the list of properties specified by `plugins:java_server:system_properties`.
- *Security log file*—if you have enabled local logging for the security service, you can specify the location of the security log file by editing the `plugins:local_log_stream:filename` configuration variable.

**Sample configuration**

**Example 35** shows a sample configuration for a security service that supports connections over the IOP/TLS transport protocol. In this example, the security service's configuration scope (which would be passed to the `-ORBname` parameter of the command that launches the security service) is `secure_artix.your_application.security_service`.

**Example 35: Configuration of the Artix Security Service with IOP/TLS**

```

# Artix Configuration File
secure_artix
{
1   # Generic security settings
2
   policies:trusted_ca_list_policy =
   "C:\artix_40\artix\4.0\demos\security\certificates\tls\x509\t
   rusted_ca_lists\ca_list1.pem";
3
   SECURITY_CLASSPATH =
   "C:\artix_40\lib\artix\security_service\4.0\security_service-
   rt.jar";
   ...
   your_application
   {
4     initial_references:IT_SecurityService:reference =
     "corbaloc:it_iiopts:1.2@localhost:55020/IT_SecurityService";

     security_service
     {
5       password_retrieval_mechanism:inherit_from_parent =
       "true";
6
       principal_sponsor:use_principal_sponsor = "true";
       principal_sponsor:auth_method_id = "pkcs12_file";
       principal_sponsor:auth_method_data =
       ["filename=C:\artix_40\artix\4.0\demos\security\certificates/
       tls\x509/certs/services/administrator.p12",
       "password_file=C:\artix_40\artix\4.0\demos\security\certifica
       tes\tls\x509/certs/services/administrator.pwf"];

       binding:client_binding_list = ["GIOP+EGMIOP",
       "OTS+TLS_Coloc+POA_Coloc", "TLS_Coloc+POA_Coloc",
       "OTS+POA_Coloc", "POA_Coloc", "GIOP+SHMIOP",
       "CSI+OTS+GIOP+IIOP_TLS", "OTS+GIOP+IIOP_TLS",
       "CSI+GIOP+IIOP_TLS", "GIOP+IIOP_TLS", "CSI+OTS+GIOP+IIOP",
       "OTS+GIOP+IIOP", "CSI+GIOP+IIOP", "GIOP+IIOP"];

```

**Example 35:** Configuration of the Artix Security Service with IIOP/TLS

```

7      policies:target_secure_invocation_policy:requires =
["Confidentiality", "Integrity", "DetectReplay",
"DetectMisordering"];
      policies:target_secure_invocation_policy:supports =
["Confidentiality", "EstablishTrustInTarget",
"EstablishTrustInClient", "DetectMisordering",
"DetectReplay", "Integrity"];
      policies:client_secure_invocation_policy:requires =
["Confidentiality", "Integrity", "DetectReplay",
"DetectMisordering"];
      policies:client_secure_invocation_policy:supports =
["Confidentiality", "EstablishTrustInTarget",
"EstablishTrustInClient", "DetectMisordering",
"DetectReplay", "Integrity"];

8      orb_plugins = ["local_log_stream", "iiop_profile",
"giop", "iiop_tls"];

9      generic_server_plugin = "java_server";
      plugins:java_server:shlib_name = "it_java_server";
10     plugins:java_server:class =
"com.iona.corba.security.services.SecurityServer";
      plugins:java_server:classpath = "%{SECURITY_CLASSPATH}";
      plugins:java_server:jni_verbose = "false";
      plugins:java_server:X_options = ["rs"];

11     #event_log:filters = ["IT_SECURITY=WARN+ERROR+FATAL",
"IT_JAVA_SERVER="];
      plugins:security:direct_persistence = "true";

12     plugins:java_server:system_properties =
["org.omg.CORBA.ORBClass=com.iona.corba.art.artimpl.ORBImpl",
"org.omg.CORBA.ORBSingletonClass=com.iona.corba.art.artimpl.O
RBSingleton",
"is2.properties=C:\artix_40\artix\4.0\demos/security/full_sec
urity/cxx/security_service/is2.properties.FILE",
"java.endorsed.dirs=C:\artix_40\artix\4.0\lib\endorsed"];
13     plugins:local_log_stream:filename =
"C:\artix_40\artix\4.0\demos/security/full_security/cxx/secur
ity_service/isf.log";

14     plugins:security:iiop_tls:port = "55020";
      plugins:security:iiop_tls:host = "localhost";

```

**Example 35:** Configuration of the Artix Security Service with IIOP/TLS

```

15     policies:security_server:client_certificate_constraints
      = ["CN=*"];
16
      policies:external_token_issuer:client_certificate_constraints
      = [];
      };
    };
  };
};

```

The preceding configuration can be explained as follows:

1. Most of the settings appearing in the `secure_artix` scope are entirely generic and never need to be edited.
2. By default, the trusted CA list points at a demonstration CA certificate. Before deploying the Artix security service, you must replace this demonstration CA list by a list of CA certificates that are genuinely trustworthy.

**WARNING:** The default trusted CA list is provided for demonstration purposes only. It is *not* secure, because every installation of Artix uses the same demonstration certificates. You must replace the CA certificate list when you deploy the Artix security service to a live system.

3. The `SECURITY_CLASSPATH` substitution variable specifies the location of the JAR file containing the implementation of the Artix security service. If you move the Artix JAR files to a non-standard location, you would have to update this file location.
4. The `IT_SecurityService` initial reference setting provides the endpoint details for connecting to the security service through the IIOP/TLS protocol. You should ensure that this setting is available in the scope of any Artix application that needs to connect to the security service. The initial reference is specified as a corbaloc URL, in the following format:

```
corbaloc:it_iiopts:1.2@SecurityHost:SecurityPort/IT_Security
Service
```

Where `SecurityHost` and `SecurityPort` are the host and port for the security service.

5. Setting the password retrieval mechanism to obtain the private key password from a parent process is a technicality, which is required because the security service implementation forks a new process.
6. The principal sponsor settings are used to set the security service's own X.509 certificate. The security service uses this certificate during SSL/TLS handshakes to identify itself to other programs.  
Before deploying the security service to a live system, you *must* replace the demonstration certificate with a secure custom certificate. For details of how to configure the principal sponsor, see [“Deploying Application Certificates” on page 254](#).

**WARNING:** The security service's default own certificate is provided for demonstration purposes only. It is *not* secure, because every installation of Artix uses the same demonstration certificates. You must replace the own certificate when you deploy the Artix security service to a live system.

7. The following lines set the minimum requirements for the target secure invocation policy and the client secure invocation policy. The security service implicitly augments these security policies by requiring the `EstablishTrustInClient` association option for the target secure invocation policy. In other words, the security service *always* expects a client to present an X.509 certificate, irrespective of what appears in the configuration.
8. The `orb_plugins` list loads plug-ins to support the local log stream and the IIOP/TLS transport protocol.
9. The following lines configure the Artix generic server.  
The core of the Artix security service is implemented as a pure Java program. To make the security service accessible through the IIOP/TLS protocol, the Java code is hosted inside an Artix generic server.
10. The `plugins:java_server:class` setting specifies the entry point for the Java implementation of the security service. Currently, there are two possible entry points:
  - ◆ `com.ionacorba.security.services.SecurityServer`—this entry point is suitable for a security service that supports the IIOP/TLS transport protocol.

- ◆ `com.ionajbus.security.services.SecurityServer`—this entry point is suitable for a security service that supports other Artix protocols, such as HTTPS. See [“Security Service Accessible through HTTPS” on page 156](#) for more details.
11. To enable an error log for the security service, uncomment this line.
  12. This line sets the system properties for the Java implementation of the security service. In particular, the `is2.properties` property specifies the location of a properties file, which contains further property settings for the Artix security service.
  13. The `plugins:local_log_stream:filename` specifies the location of the security service’s log file.
  14. These two variables, `plugins:security:iiop_tls:port` and `plugins:security:iiop_tls:host`, specify the host and IP port where the security service listens for incoming connections. Therefore, if you want to change the security service’s listening address, you should edit these settings.
  15. The security service requires that any clients attempting to open a connection must present an X.509 certificate to identify themselves. In addition, the security service supports a primitive form of access control: client certificates will be rejected unless they conform to the constraints specified in `policies:security_server:client_certificate_constraints`. For details of how to specify certificate constraints, see [“Applying Constraints to Certificates” on page 401](#).

**Note:** The

`policies:security_server:client_certificate_constraints` setting must be present in the security service’s configuration scope, otherwise the security service will not start.

16. The security service supports a special kind of access, where a client can obtain security tokens without providing a password, based on a username alone. This type of access is needed to support interoperability with the mainframe platform. Normally, however, this feature should be disabled to avoid opening a security hole.



To disable the token issuer, set the token issuer's certificate constraints to be an empty list (as shown here). This causes the token issuer to reject all clients, effectively disabling this feature.

**Note:** The `policies:external_token_issuer:client_certificate_constraints` setting must be present in the security service's configuration scope, otherwise the security service will not start.

---

## Security Service Accessible through HTTPS

---

### Overview

This section describes how to configure a security service that is made accessible through the HTTPS protocol. A key difference between the HTTPS-based security service and the IIOP/TLS-based security service is that the HTTPS-based variant uses an *Artix enabled* security service. The HTTPS-based variant also requires you to configure clients differently.

---

### Location of demonstration

The full security demonstration shows how to configure and run a HTTPS-based security service. The demonstration code is located in the following directory:

```
ArtixInstallDir/artix/Version/demos/security/full_security
```

---

### Artix enabled security service

In versions of Artix prior to 4.0, the Artix security service is available *only* as a pure CORBA service. The architecture for this security service is based on a pure Java core (the core implementation of the security service) which is loaded into an Artix generic server. The generic server provides an OMG IDL wrapper interface, which enables the core service to be accessed through the IIOP/TLS protocol.

From Artix 4.0 onwards, a more flexible type of architecture is provided that makes the security service accessible through *any* Artix transport—that is, the security service is *Artix enabled*. Using this approach, the security service is deployed as a regular Artix service with its own WSDL contract. Just as with any other Artix service, you can select the transport and modify the endpoint attributes by editing the security service's WSDL contract.

---

### Configuring clients of the Artix enabled security service

If you configure the security service to be Artix enabled, you must also configure the clients of the security service appropriately (in this context, *client* means any program that communicates with the security service—for example, the client could be an Artix server).

To configure an Artix program to communicate with the Artix enabled security service, make the following modifications to the program's configuration:

- *Load the Artix security plug-in*—this is a basic prerequisite for communication with the Artix security service. See [“The Artix Security Plug-In” on page 138](#).
- *Enable Artix proxies in the security plug-in*—set the `policies:asp:use_artix_proxies` configuration variable to `true`.
- *Specify the location of the security service WSDL contract*—set the `bus:initial_contract:url:isf_service` configuration variable to the location of the contract.

**Note:** This is not the only way of specifying the location of a WSDL contract. See the Finding Contracts and References chapter of the *Configuring and Deploying Artix Solutions* guide for more details.

For example, the following configuration sample, `your_artix_server`, highlights the settings that need to be modified in order to access an Artix enabled security service:

```
# Artix Configuration File
your_artix_server
{
    orb_plugins = [..., "artix_security", ...];
    ...
    policies:asp:use_artix_proxies = "true";
    bus:initial_contract:url:isf_service =
    "../../etc/isf_service.wsdl";
    ...
};
```

A sample copy of the security service WSDL contract, `isf_service.wsdl`, is provided in the following directory:

`ArtixInstallDir/artix/Version/demos/security/full_security/etc`

### Instantiation of an Artix Bus in the security service

In order to expose the security service as an Artix service, you need to configure the generic server to create an Artix Bus in which the Artix enabled security service can run.

To configure the generic server to instantiate an Artix Bus, perform the following steps:

1. In the `security_service` configuration scope, edit the `plugins:java_server:class` setting and set it equal to `com.iona.jbus.security.services.SecurityServer`.
2. Add a `bus` sub-scope to the `security_service` configuration scope. The `bus` sub-scope is used to configure the Artix enabled security service.

In outline, the modified configuration would look as follows:

```
# Artix Configuration File
security_service
{
  # Security Service Configuration Settings
  ...
  plugins:java_server:class =
  "com.iona.jbus.security.services.SecurityServer";
  ...
  bus
  {
    # HTTPS-Based Security Service Configuration Settings
    ...
  };
};
```

### Customising the security service configuration

To configure the HTTPS-based security service, see the following topics:

- [Setting the HTTPS-based security service's host and port.](#)
- [Location of the security service WSDL contract.](#)
- [Replacing X.509 certificates.](#)
- [Setting client certificate constraints.](#)
- [Minimum level of security.](#)
- [Dependency on secure WSDL publishing service.](#)
- [Relocating files.](#)
- [Sample configuration.](#)

### Setting the HTTPS-based security service's host and port

The HTTPS-based security service's address details are specified in the security service's WSDL contract. If you want to change the security service's address, edit the relevant `location` attribute in the security service endpoint.

[Example 36](#) shows a security service endpoint with a location attribute equal to `https://localhost:59075/services/security/ServiceManager`.

#### Example 36: Address Details in the Security Service WSDL Contract

```
<definitions name="isf_service"
  targetNamespace="http://schemas.iona.com/idl/isf_service.idl"
  xmlns="http://schemas.xmlsoap.org/wsdl/"
  xmlns:addressing="http://schemas.iona.com/references"
  xmlns:http="http://schemas.xmlsoap.org/wsdl/http/"

  xmlns:http-conf="http://schemas.iona.com/transport/http/configuration"
  xmlns:soap="http://schemas.xmlsoap.org/wsdl/soap/"
  xmlns:tns="http://schemas.iona.com/idl/isf_service.idl"
  xmlns:xsd="http://www.w3.org/2001/XMLSchema"

  xmlns:xsd1="http://schemas.iona.com/idl/types/isf_service.idl"
>
...
  <service name="IT_ISF.ServiceManagerSOAPService">
    <port binding="tns:IT_ISF.ServiceManagerSOAPBinding"
      name="IT_ISF.ServiceManagerSOAPPort">
      <http:address location =
        "https://localhost:59075/services/security/ServiceManager"
      />
    </port>
  </service>
</definitions>
```

### Location of the security service WSDL contract

The location of the security service WSDL contract is specified by the value of the `bus:initial_contract:url:isf_service` variable in the `bus` sub-scope of the security service's configuration scope.

A sample copy of the security service WSDL contract, `isf_service.wsdl`, is provided in the following directory:

`ArtixInstallDir/artix/Version/demos/security/full_security/etc`

---

## Replacing X.509 certificates

The security service is provided with demonstration X.509 certificates by default. Whilst this is convenient for running demonstrations and tests, it is fundamentally insecure, because Artix provides identical demonstration certificates for every installation.

Before deploying the security service in a live system, therefore, you *must* replace the default X.509 certificates with your own custom-generated certificates. Specifically, for the security service you must replace the following certificates:

- *Trusted CA list*—this is a list of trusted Certification Authority (CA) certificates, which is used to vet certificates presented by clients. Only certificates signed by one of the CAs on the trusted list will be allowed to connect to the security service.

To update the trusted CA list, edit the

`plugins:at_http:server:trusted_root_certificates` variable in the `bus` sub-scope of the the security service's configuration scope. For more details, see [“Deploying Trusted Certificate Authority Certificates” on page 248](#).

- *Security service's own certificate*—the security service uses its own X.509 certificate to identify itself to peers during SSL/TLS handshakes.

To replace the security service's own certificate, edit the

`plugins:at_http:server:server_certificate` and the `plugins:at_http:server:server_private_key_password` settings in the `bus` sub-scope of the security service's configuration scope. For more details, see [“Deploying Application Certificates” on page 254](#).

---

## Setting client certificate constraints

To provide a basic level of access control, the security service enables you to set client certificate constraints, which prevents clients from opening a connection to the security service unless they present a certificate that matches the specified constraints.

To specify the HTTPS-based security service's client certificate constraints, assign the constraints to the `policies:certificate_constraints_policy` configuration variable in the `bus` configuration sub-scope (for details of how to specify constraints, see [“Applying Constraints to Certificates” on page 401](#)).

**Note:** The HTTPS-based security service sets certificate constraints using a different variable, `policies:certificate_constraints_policy`, from the one used by the IIOP/TLS-based security service, `policies:security_server:client_certificate_constraints`.

---

### Minimum level of security

In the case of the HTTPS-based security service, the minimum security requirements for SSL/TLS communications are specified explicitly by the effective target secure invocation policy (which can be specified using the `policies:target_secure_invocation_policy:requires` variable).

Because it is an important security requirement for clients of the security service to present an X.509 certificate, you should take care that the target secure invocation policy in the bus configuration sub-scope always includes the `EstablishTrustInClient` association option.

---

### Dependency on secure WSDL publishing service

The HTTPS-based security service requires that the secure WSDL publishing service is loaded and enabled. The WSDL publishing service enables clients of the security service to download WSDL contracts containing particular security service interfaces at runtime.

For more details about the secure WSDL publishing service, see [“Publishing WSDL Securely” on page 123](#).

---

### Relocating files

The security service depends on several directories and files, which might need to be relocated when it comes to deployment time. Some directories and files that might be relocated are, as follows:

- *Artix install directory*—if you manually move the core files in the Artix installation, this would affect the location of certain library directories that the security service depends on. The following configuration settings would be affected:
  - ◆ `SECURITY_CLASSPATH`—a substitution variable that specifies the location of the JAR file containing the security service code.

- ◆ `plugins:java_server:system_properties`—amongst this list of properties, the `java.endorsed.dirs` property would be affected.
- *iS2 properties file*—this is an important file that provides additional security service configuration through Java properties. You can alter the location of this file by editing the `is2.properties` property in the list of properties specified by `plugins:java_server:system_properties`.
- *Security log file*—if you have enabled local logging for the security service, you can specify the location of the security log file by editing the `plugins:local_log_stream:filename` configuration variable.
- *iSF service file*—you can change the location of the WSDL contract file for the HTTPS-based security service by editing the `bus:initial_contract:url:isf_service` configuration variable.

## Sample configuration

[Example 37](#) shows a sample configuration for a security service that supports connections over the HTTPS transport protocol. In this example, the security service's configuration scope (which would be passed to the `-ORBname` parameter of the command that launches the security service) is `secure_artix.your_application.security_service`.

### Example 37: Configuration of the Artix Security Service with HTTPS

```

1 include "../../../etc/domains/artix.cfg";
  include "../../../etc/domains/artix-secure.cfg";

  secure_artix
  {
    # Generic security settings
    ...
    your_application
    {
      ...
      security_service
      {
        ...
2         generic_server_plugin = "java_server";
3         plugins:java_server:shlib_name = "it_java_server";
         plugins:java_server:class =
"com.iona.jbus.security.services.SecurityServer";
         plugins:java_server:classpath = "%{SECURITY_CLASSPATH}";
         plugins:java_server:jni_verbose = "false";

```



**Example 37:** Configuration of the Artix Security Service with HTTPS

```

4     plugins:java_server:X_options = ["rs"];
      #event_log:filters = ["IT_SECURITY=WARN+ERROR+FATAL",
"IT_JAVA_SERVER="];
      plugins:security:direct_persistence = "true";

5     plugins:java_server:system_properties =
["org.omg.CORBA.ORBClass=com.ionacorba.art.artimpl.ORBImpl",
"org.omg.CORBA.ORBSingletonClass=com.ionacorba.art.artimpl.ORBSingleton",
"is2.properties=%{INSTALL_DIR}/%{PRODUCT_NAME}/%{PRODUCT_VERSION}/demos/security/full_security/etc/is2.properties.FILE",
"java.endorsed.dirs=%{INSTALL_DIR}/%{PRODUCT_NAME}/%{PRODUCT_VERSION}/lib/endorsed"];

6     plugins:local_log_stream:filename =
"%{INSTALL_DIR}/%{PRODUCT_NAME}/%{PRODUCT_VERSION}/demos/security/full_security/etc/isf.log";
      ...
      bus
      {
7         orb_plugins = ["local_log_stream", "java",
"wsdl_publish"];
8         java_plugins= ["isf"];
plugins:isf:classname="com.ionajbus.security.services.ISFBusPluginFactory";

9         bus:initial_contract:url:isf_service =
"%{INSTALL_DIR}/%{PRODUCT_NAME}/%{PRODUCT_VERSION}/demos/security/full_security/etc/isf_service.wsdl";

10        plugins:wsdl_publish:enable_secure_wsdl_publish="true";

11        plugins:at_http:server:use_secure_sockets="true";
12        plugins:at_http:server:trusted_root_certificates =
"%{ROOT_TRUSTED_CA_LIST_POLICY_1}";
13        plugins:at_http:server:server_certificate =
"%{PRIVATE_CERT_1}";
      plugins:at_http:server:server_private_key_password =
"%{PRIVATE_CERT_PASSWORD_1}";
14        policies:target_secure_invocation_policy:requires =
["Confidentiality", "Integrity", "DetectMisordering",
"DetectReplay", "EstablishTrustInClient"];
15        policies:certificate_constraints_policy =
["%{CERT_CONSTRAINT_1}"];

```



6. The `plugins:local_log_stream:filename` specifies the location of the security service's log file.
7. The `orb_plugins` list in the bus scope must include the following plug-ins:
  - ♦ `java plug-in`—enables the Artix Java plug-in mechanism, which can then be loaded using the `java_plugins` list.
  - ♦ `wSDL_publish plug-in`—loads the WSDL publishing service, which enables clients of the security service to download WSDL contracts. In order to access some of the security service's interfaces, the client must download the relevant WSDL contracts through the publishing service.
8. The `java_plugins` list lets you load Artix Java plug-ins (see *Developing Artix Applications in Java* for more details) and in this case a single plug-in, `isf`, is loaded. The `isf` plug-in is responsible for exposing the security service core as an Artix service.

The `plugins:isf:classname` variable specifies the entry point for the implementation of the `isf` plug-in.
9. This setting specifies the location of the security service's WSDL contract. You will generally need to edit this WSDL contract, to specify the security service's host and port.
10. This setting enables HTTPS-related security features for the WSDL publishing service. For more details about securing the WSDL publishing service, see [“Enabling SSL/TLS for WSDL Publish Plug-In” on page 132](#).
11. This setting ensures that the security service and the WSDL publishing service accept incoming connections only over HTTPS, instead of insecure HTTP, and implicitly causes the `https` plug-in to load.
12. If the client presents a certificate to the security service, Artix checks to make sure that the client certificate is signed by one of the CAs in the trusted CA list specified here.
13. This line specifies the X.509 certificate that the security server presents to incoming HTTPS connections during an SSL/TLS handshake.

14. The specified target secure invocation policy includes the `EstablishTrustInClient` association option, which ensures that the security service accepts connections *only* from clients that present an X.509 certificate.
15. The HTTPS-based security service supports a primitive form of access control, whereby client certificates are rejected unless they conform to the constraints specified in `policies:certificate_constraints_policy`.  
For details of how to specify certificate constraints, see [“Applying Constraints to Certificates” on page 401](#).

**Note:** The `policies:certificate_constraints_policy` setting is fundamentally important for securing the security service. This is the only mechanism that the security service can use to restrict access to itself.

---

# Configuring the File Adapter

## Overview

The iSF file adapter enables you to store information about users, roles, and realms in a flat file, a *security information file*. The file adapter is easy to set up and configure, but is appropriate mainly for demonstration purposes and small deployments. This section describes how to set up and configure the iSF file adapter.

**Note:** The file adapter is a simple adapter that does *not* scale well for large enterprise applications. IONA supports the use of the file adapter in a production environment, but the number of users is limited to 200.

## File locations

The following files configure the iSF file adapter:

- `is2.properties` file—the default location of the iS2 properties file is as follows:

```
ArtixInstallDir/artix/2.0/bin/is2.properties
```

See “iSF Properties File” on page 487 for details of how to customize the default iS2 properties file location.

- Security information file—this file’s location is specified by the `com.iona.isp.adapter.file.param.filename` property in the `is2.properties` file.

## File adapter properties

[Example 38](#) shows the properties to set for a file adapter.

### Example 38: Sample File Adapter Properties

```
1 com.iona.isp.adapters=file
#####
##
## Demo File Adapter Properties
##
#####
2 com.iona.isp.adapter.file.class=com.iona.security.is2adapter.file.FileAuthAdapter
```

**Example 38: Sample File Adapter Properties**

```
3 com.iona.isp.adapter.file.param.filename=ArtixInstallDir/artix/2
  .0/bin/is2_user_password_role_file.txt

#####
## General Artix security service Properties
#####
4 # ... Generic properties not shown here ...
```

The necessary properties for a file adapter are described as follows:

1. Set `com.iona.isp.adapters=file` to instruct the Artix security service to load the file adapter.
2. The `com.iona.isp.adapter.file.class` property specifies the class that implements the iSF file adapter.
3. The `com.iona.isp.adapter.file.param.filename` property specifies the location of the security information file, which contains information about users and roles.
4. (*Optionally*) You might also want to edit the general Artix security service properties.

See [“Additional Security Configuration” on page 196](#) for details.

---

# Configuring the LDAP Adapter

---

## Overview

The IONA security platform integrates with the Lightweight Directory Access Protocol (LDAP) enterprise security infrastructure by using an LDAP adapter. The LDAP adapter is configured in an `is2.properties` file. This section discusses the following topics:

- [Prerequisites](#)
- [File location](#).
- [Minimal LDAP configuration](#).
- [Basic LDAP properties](#).
- [LDAP.param properties](#).
- [LDAP server replicas](#).
- [Logging on to an LDAP server](#).

---

## Prerequisites

Before configuring the LDAP adapter, you must have an LDAP security system installed and running on your system. LDAP is *not* a standard part of Artix, but you can use the Artix security service's LDAP adapter with any LDAP v.3 compatible system.

---

## File location

The following file configures the LDAP adapter:

- `is2.properties` file—the default location of the iS2 properties file is as follows:

```
ArtixInstallDir/artix/2.0/is2.properties
```

See [“iSF Properties File” on page 487](#) for details of how to customize the default iS2 properties file location.

**Minimal LDAP configuration**

**Example 39** shows the minimum set of iS2 properties that can be used to configure an LDAP adapter.

**Example 39: A Sample LDAP Adapter Configuration File**

```

1  com.iona.isp.adapters=LDAP
   #####
   ##
   ## LDAP Adapter Properties
   ##
   #####
2  com.iona.isp.adapter.LDAP.class=com.iona.security.is2adapter.LdapAdapter

3  com.iona.isp.adapter.LDAP.param.host.1=10.81.1.400
   com.iona.isp.adapter.LDAP.param.port.1=389

4  com.iona.isp.adapter.LDAP.param.UserNameAttr=uid
   com.iona.isp.adapter.LDAP.param.UserBaseDN=dc=iona,dc=com
   com.iona.isp.adapter.LDAP.param.UserObjectClass=organizationalPerson
   com.iona.isp.adapter.LDAP.param.UserSearchScope=SUB

5  com.iona.isp.adapter.LDAP.param.UserRoleDNAttr=nsroledn
   com.iona.isp.adapter.LDAP.param.RoleNameAttr=cn

6  com.iona.isp.adapter.LDAP.param.GroupNameAttr=cn
   com.iona.isp.adapter.LDAP.param.GroupObjectClass=groupofuniqueNames
   com.iona.isp.adapter.LDAP.param.GroupSearchScope=SUB
   com.iona.isp.adapter.LDAP.param.GroupBaseDN=dc=iona,dc=com
   com.iona.isp.adapter.LDAP.param.MemberDNAttr=uniqueMember

7  com.iona.isp.adapter.LDAP.param.version=3

```

The necessary properties for an LDAP adapter are described as follows:

1. Set `com.iona.isp.adapters=LDAP` to instruct the IONA Security Platform to load the LDAP adapter.
2. The `com.iona.isp.adapter.file.class` property specifies the class that implements the LDAP adapter.



3. For each LDAP server replica, you must specify the host and port where the LDAP server can be contacted. In this example, the host and port parameters for the primary LDAP server, `host.1` and `port.1`, are specified.
4. These properties specify how the LDAP adapter finds a user name within the LDAP directory schema. The properties are interpreted as follows:

<code>UserNameAttr</code>	The attribute type whose corresponding value uniquely identifies the user.
<code>UserBaseDN</code>	The base DN of the tree in the LDAP directory that stores user object class instances.
<code>UserObjectClass</code>	The attribute type for the object class that stores users.
<code>UserSearchScope</code>	The user search scope specifies the search depth relative to the user base DN in the LDAP directory tree. Possible values are: <code>BASE</code> , <code>ONE</code> , or <code>SUB</code> .

See [“ISF Properties File” on page 487](#) for more details.

5. The following properties specify how the adapter extracts a user’s role from the LDAP directory schema:

<code>UserRoleDNAttr</code>	The attribute type that stores a user’s role DN.
<code>RoleNameAttr</code>	The attribute type that the LDAP server uses to store the role name.

6. These properties specify how the LDAP adapter finds a group name within the LDAP directory schema. The properties are interpreted as follows:

<code>GroupNameAttr</code>	The attribute type whose corresponding attribute value gives the name of the user group.
<code>GroupBaseDN</code>	The base DN of the tree in the LDAP directory that stores user groups.
<code>GroupObjectClass</code>	The object class that applies to user group entries in the LDAP directory structure.

GroupSearchScope	The group search scope specifies the search depth relative to the group base DN in the LDAP directory tree. Possible values are: BASE, ONE, or SUB.
MemberDNAttr	The attribute type that is used to retrieve LDAP group members.

See “[iSF Properties File](#)” on page 487 for more details.

- The LDAP version number can be either 2 or 3, corresponding to LDAP v.2 or LDAP v.3 respectively.

## Basic LDAP properties

The following properties must always be set as part of the LDAP adapter configuration:

```
com.iona.isp.adapters=LDAP
com.iona.isp.adapter.LDAP.class=com.iona.security.is2adapter.ldap.LdapAdapter
```

In addition to these basic properties, you must also set a number of LDAP parameters, which are prefixed by `com.iona.isp.adapter.LDAP.param`.

**LDAP.param properties**

Table 3 shows all of the LDAP adapter properties from the `com.iona.isp.adapter.LDAP.param` scope. Required properties are shown in bold:

**Table 3:** *LDAP Properties in the com.iona.isp.adapter.LDAP.param Scope*

LDAP Server Properties	LDAP User/Role Configuration Properties
<b>host</b> .<Index> <b>port</b> .<Index> SSLEnabled.<Index> SSLCACertDir.<Index> SSLClientCertFile.<Index> SSLClientCertPassword.<Index> PrincipalUserDN.<Index> PrincipalUserPassword.<Index>	<b>UserNameAttr</b> <b>UserBaseDN</b> <b>UserObjectClass</b> <b>UserSearchScope</b> UserSearchFilter <b>UserRoleDNAttr</b> <b>RoleNameAttr</b> UserCertAttrName
LDAP Group/Member Configuration Properties	Other LDAP Properties
<b>GroupNameAttr</b> <b>GroupObjectClass</b> <b>GroupSearchScope</b> <b>GroupBaseDN</b> <b>MemberDNAttr</b> MemberFilter	MaxConnectionPoolSize <b>version</b> UseGroupAsRole RetrieveAuthInfo CacheSize CacheTimeToLive

**LDAP server replicas**

The LDAP adapter is capable of failing over to one or more backup replicas of the LDAP server. Hence, properties such as `host.<Index>` and `port.<Index>` include a replica index as part of the parameter name.

For example, `host.1` and `port.1` refer to the host and port of the primary LDAP server, while `host.2` and `port.2` would refer to the host and port of an LDAP backup server.

---

**Logging on to an LDAP server**

The following properties can be used to configure login parameters for the <Index> LDAP server replica:

PrincipalUserDN. <Index>  
PrincipalUserPassword. <Index>

The properties need only be set if the LDAP server is configured to require username/password authentication.

---

**Secure connection to an LDAP server**

The following properties can be used to configure SSL/TLS security for the connection between the Artix security service and the <Index> LDAP server replica:

SSLEnabled. <Index>  
SSLCACertDir. <Index>  
SSLClientCertFile. <Index>  
SSLClientCertPassword. <Index>

The properties need only be set if the LDAP server requires SSL/TLS mutual authentication.

---

**iS2 properties reference**

For more details about the Artix security service properties, see [“iSF Properties File” on page 487](#).

---

# Configuring the Kerberos Adapter

---

## Overview

The Kerberos adapter enables you to use the Kerberos Authentication Service. By configuring the Kerberos adapter, you ensure that any authentication requests within the Artix Security Framework are delegated to Kerberos. This section describes how to set up and configure the Kerberos adapter.

---

## File location

The following file configures the Kerberos adapter:

- `is2.properties` file—the default location of the iS2 properties file is as follows:

```
ArtixInstallDir/artix/2.0/bin/is2.properties
```

See [“iSF Properties File” on page 487](#) for details of how to customize the default iS2 properties file location.

---

## Kerberos adapter properties

[Example 40](#) shows the properties to set for the Kerberos adapter.

### Example 40: Kerberos Adapter Properties

```

1  com.iona.isp.adapters=kbr5
   #####
   ##
   ##  Kerberos Adapter Properties
   ##
   #####
2  com.iona.isp.adapter.kbr5.class=com.iona.security.is2adapter.kbr
   5.IS2KerberosAdapter
3  com.iona.isp.adapter.krb5.param.java.security.krb5.realm=MYREALM
   .COMPANY.COM
   com.iona.isp.adapter.krb5.param.java.security.krb5.kdc=10.65.3.7
   4
   com.iona.isp.adapter.krb5.param.java.security.auth.login.config=
   jaas.conf
   com.iona.isp.adapter.krb5.param.javax.security.auth.useSubjectCr
   edsOnly=false

```

**Example 40: Kerberos Adapter Properties**

```
#####
## General Artix security service Properties
#####
4 # ... Generic properties not shown here ...
```

The necessary properties for a Kerberos adapter are described as follows:

1. Set `com.iona.isp.adapters=kbr5` to instruct the Artix security service to load the Kerberos adapter.
2. The `com.iona.isp.adapter.kbr5.class` property specifies the class that implements the Kerberos adapter.
3. A Kerberos adapter requires the following parameters:

<code>java.security.kbr5.realm</code>	The Kerberos Realm Name.
<code>java.security.kbr5kdc</code>	The server name or IP address of the Kerberos KDC server.
<code>java.security.auth.login.config</code>	The configuration file for the JAAS Login Module.
<code>javax.security.auth.useSubjectCredsOnly</code>	A required JAAS Login Module property. Always set to <code>false</code> .

4. (Optionally) You might also want to edit the general Artix security service properties.  
See [“Additional Security Configuration” on page 196](#) for details.

**Retrieving the user’s group information**

Once the Kerberos token has been authenticated, the Kerberos adapter can be configured to retrieve the user’s group information and save it for future authorization purposes.

[Example 41](#) shows a sample configuration for the Kerberos adapter that retrieve the user’s group information.

**Example 41: Kerberos Configuration to Retrieve User Group Information**

```
1 com.iona.isp.adapter.krb5.param.RetrieveAuthInfo=true
```

**Example 41:** *Kerberos Configuration to Retrieve User Group Information*

- ```

2 com.iona.isp.adapter.krb5.param.host.1=${ACTIVE_DIRECTORY_SERVER_
  NAMES$
com.iona.isp.adapter.krb5.param.port.1=389
com.iona.isp.adapter.krb5.param.SSLEnabled.1=no
com.iona.isp.adapter.krb5.param.SSLCACertDir.1=d:/certs/test
com.iona.isp.adapter.krb5.param.SSLClientCertFile.1=d:/certs/ver
  isign.pl2
com.iona.isp.adapter.krb5.param.SSLClientCertPassword.1=netfish
com.iona.isp.adapter.krb5.param.PrincipalUserDN.1=cn=administral
  or,cn=users,dc=boston,dc=amer,dc=iona,dc=com
com.iona.isp.adapter.krb5.param.PrincipalUserPassword.1=orbix
com.iona.isp.adapter.krb5.param.ConnectTimeout.1=15

3 com.iona.isp.adapter.krb5.param.UserNameAttr=CN
com.iona.isp.adapter.krb5.param.UserBaseDN=dc=boston,dc=amer,dc=
  iona,dc=com
com.iona.isp.adapter.krb5.param.version=3
com.iona.isp.adapter.krb5.param.UserObjectClass=Person
com.iona.isp.adapter.krb5.param.GroupObjectClass=group
com.iona.isp.adapter.krb5.param.GroupSearchScope=SUB
com.iona.isp.adapter.krb5.param.GroupBaseDN=dc=boston,dc=amer,dc
  =iona,dc=com
com.iona.isp.adapter.krb5.param.GroupNameAttr=CN
com.iona.isp.adapter.krb5.param.MemberDNAttr=memberOf
com.iona.isp.adapter.krb5.param.MaxConnectionPoolSize=1
com.iona.isp.adapter.krb5.param.MinConnectionPoolSize=1

```

The properties to configure the Kerberos adapter to retrieve a user's group information are explained as follows:

1. RetrieveAuthInfo=true activates this feature.
2. Set the connection information needed to open an LDAP connection to the Active Directory Server.

**Note:** If SSL needs to be enabled set

```
com.iona.isp.adapter.krb5.param.SSLEnabled.1=yes.
```

3. Tell the adapter how to construct a filter to search the Active Directory Server.

## Kerberos logging support

---

You can set two additional properties to check whether a valid Kerberos KDC is running when the Artix security service starts up. [Example 42](#) shows how to configure the relevant properties:

### **Example 42:** *Configuration to Enable Kerberos Logging Support*

```
# is2.properties File
check.kdc.running=true
check.kdc.principal=DummyPrincipal
```

The *DummyPrincipal* is a principal that is used for connecting to the KDC server to check whether it is running. If the KDC server is not running, the Artix security service writes a warning to its log.



---

# Clustering and Federation

---

## Overview

Clustering and federation are two distinct, but related, features of the Artix security service. Briefly, these features can be described as follows:

- *Clustering*—involves running several instances of the Artix security service to provide what is effectively a single service. By running multiple security service instances as a *cluster*, Artix enables you to support fault tolerance features. Typically, in this case all of the security services in a cluster are integrated with a single authentication database back-end.
- *Federation*—enables SSO tokens to be recognized across multiple security domains. Each security domain is served by a distinct security service instance and each security service is integrated with a different database back-end.

## In this section

This section contains the following subsections:

|                                                       |                          |
|-------------------------------------------------------|--------------------------|
| <a href="#">Federating the Artix Security Service</a> | <a href="#">page 180</a> |
| <a href="#">Failover</a>                              | <a href="#">page 185</a> |
| <a href="#">Client Load Balancing</a>                 | <a href="#">page 193</a> |

---

## Federating the Artix Security Service

---

### Overview

Federation is meant to be used in deployment scenarios where there is more than one instance of an Artix security service. By configuring the Artix security service instances as a federation, the security services can talk to each other and access each other's session caches. Federation frequently becomes necessary when single sign-on (SSO) is used, because an SSO token can be verified only by the security service instance that originally generated it.

---

### Federation is not clustering

Federation is not the same thing as clustering. In a federated system, user data is not replicated across different security service instances and there are no fault tolerance features provided.

---

### Example federation scenario

Consider a simple federation scenario consisting of two security domains, each with their own Artix security service instances, as follows:

- *LDAP security domain*—consists of an Artix security service (with `is2.current.server.id` property equal to 1) configured to store user data in an LDAP database. The domain includes any Artix applications that use this Artix security service (ID=1) to verify credentials.  
In this domain, a login server is deployed which enables clients to use single sign-on.
- *Kerberos security domain*—consists of an Artix security service (with `is2.current.server.id` property equal to 2) configured to store user data in a Kerberos database. The domain includes any Artix applications that use this Artix security service (ID=2) to verify credentials.

The two Artix security service instances are federated, using the configuration described later in this section. With federation enabled, it is possible for single sign-on clients to make invocations that cross security domain boundaries.

## Federation scenario

Figure 24 shows a typical scenario that illustrates how iSF federation might be used in the context of an Artix system.

Figure 24: An iSF Federation Scenario

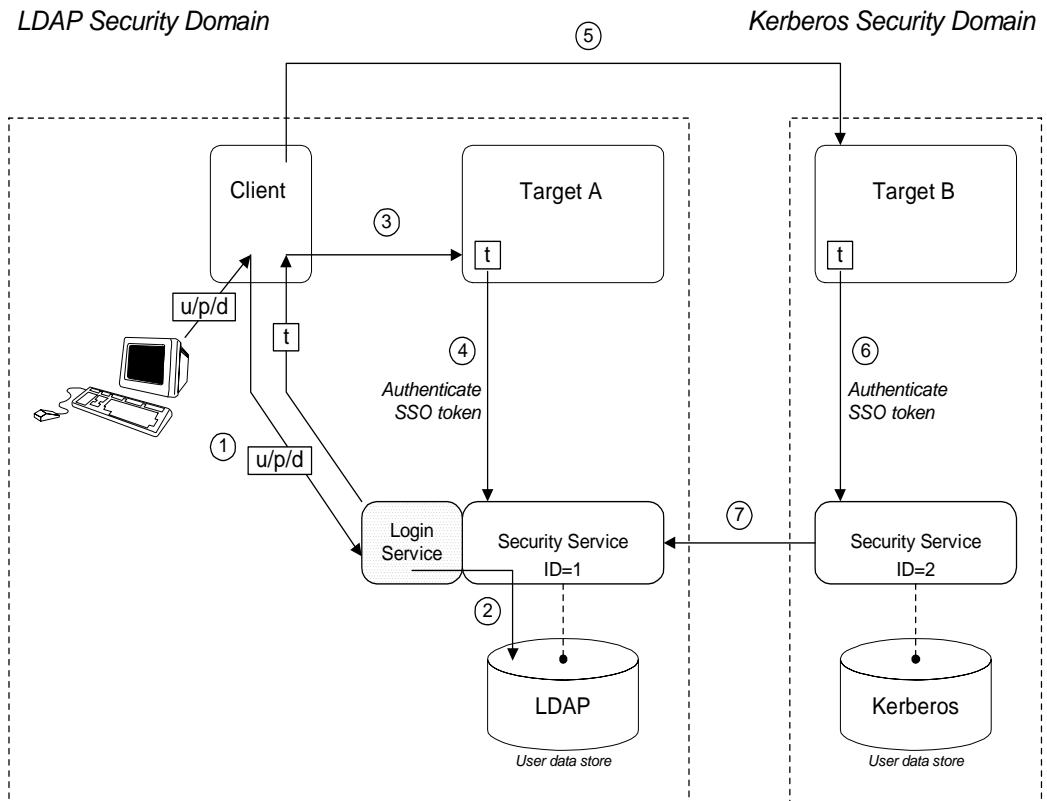

**Federation scenario steps**

The federation scenario in [Figure 24 on page 181](#) can be described as follows:

| Stage | Description                                                                                                                                                                                                                                                                                                                                  |
|-------|----------------------------------------------------------------------------------------------------------------------------------------------------------------------------------------------------------------------------------------------------------------------------------------------------------------------------------------------|
| 1     | With single sign-on (SSO) enabled, the client calls out to the login service, passing in the client's GSSUP credentials, $u/p/d$ , in order to obtain an SSO token, $\tau$ .                                                                                                                                                                 |
| 2     | The login service delegates authentication to the Artix security server (ID=1), which retrieves the user's account data from the LDAP backend.                                                                                                                                                                                               |
| 3     | The client invokes an operation on the <i>Target A</i> , belonging to the LDAP security domain. The SSO token, $\tau$ , is included in the message.                                                                                                                                                                                          |
| 4     | <i>Target A</i> passes the SSO token to the Artix security server (ID=1) to be authenticated. If authentication is successful, the operation is allowed to proceed.                                                                                                                                                                          |
| 5     | Subsequently, the client invokes an operation on the <i>Target B</i> , belonging to the Kerberos security domain. The SSO token, $\tau$ , obtained in step 1 is included in the message.                                                                                                                                                     |
| 6     | <i>Target B</i> passes the SSO token to the second Artix security server (ID=2) to be authenticated.                                                                                                                                                                                                                                         |
| 7     | The second Artix security server examines the SSO token. Because the SSO token is tagged with the first Artix security server's ID (ID=1), verification of the token is delegated to the first Artix security server. The second Artix security server opens an IIOP/TLS connection to the first Artix security service to verify the token. |

**Configuring the is2.properties files**

Each instance of the Artix security service should have its own `is2.properties` file. Within each `is2.properties` file, you should set the following:

- `is2.current.server.id`—a unique ID for this Artix security service instance,
- `is2.cluster.properties.filename`—a shared cluster file.
- `is2.sso.remote.token.cached`—a boolean property enables caching of remote token credentials in a federated system.

With caching enabled, the call from one federated security service to another (step 7 of [Figure 24 on page 181](#)) is only necessary to authenticate a token for the first time. For subsequent authentications, the security service (with ID=2) can obtain the token's security data from its own token cache.

For example, the first Artix security server instance from [Figure 24 on page 181](#) could be configured as follows:

```
# is2 Properties File, for Server ID=1
...
#####
## iSF federation related properties
#####
is2.current.server.id=1
is2.cluster.properties.filename=C:/is2_config/cluster.properties
is2.sso.remote.token.cached=true
...
```

And the second Artix security server instance from [Figure 24 on page 181](#) could be configured as follows:

```
# is2 Properties File, for Server ID=2
...
#####
## iSF federation related properties
#####
is2.current.server.id=2
is2.cluster.properties.filename=C:/is2_config/cluster.properties
is2.sso.remote.token.cached=true
...
```

**Configuring the cluster properties file**

All the Artix security server instances within a federation should share a cluster properties file. For example, the following extract from the `cluster.properties` file shows how to configure the pair of embedded Artix security servers shown in [Figure 24 on page 181](#).

```
# Advertise the locations of the security services in the cluster.
com.ionasecurity.common.securityInstanceURL.1=corbaloc:it_iops:1.2@security_ldap1:5001/IT_SecurityService
com.ionasecurity.common.securityInstanceURL.2=corbaloc:it_iops:1.2@security_ldap2:5002/IT_SecurityService
```

This assumes that the first security service (ID=1) runs on host `security_ldap1` and IP port 5001; the second security service (ID=2) runs on host `security_ldap2` and IP port 5002. To discover the appropriate host and port settings for the security services, check the `plugins:security:iop_tls` settings in the relevant configuration scope in the relevant Artix configuration file for each federated security service.

The `securityInstanceURL.ServerID` variable advertises the location of a security service in the cluster. Normally, the most convenient way to set these values is to use the `corbaloc` URL format.

---

# Failover

## Overview

---

To support *high availability* of the Artix security service, Artix implements the following features:

- *Failover*—the security service is contacted using an IOR that contains the address of *every* security service in a cluster. Hence, if one of the services in the cluster crashes, or otherwise becomes unavailable, an application can automatically try one of the alternative addresses listed in the IOR.

This subsection describes how to configure failover.

**Failover scenario**

**Example 25** shows a scenario for a highly available Artix security service that consists of a cluster of three security services. The security services run on separate hosts, `security01`, `security02`, and `security03` respectively, and all of the services rely on the same third-party LDAP database to store their user data.

**Figure 25:** Failover Scenario for a Cluster of Three Security Services

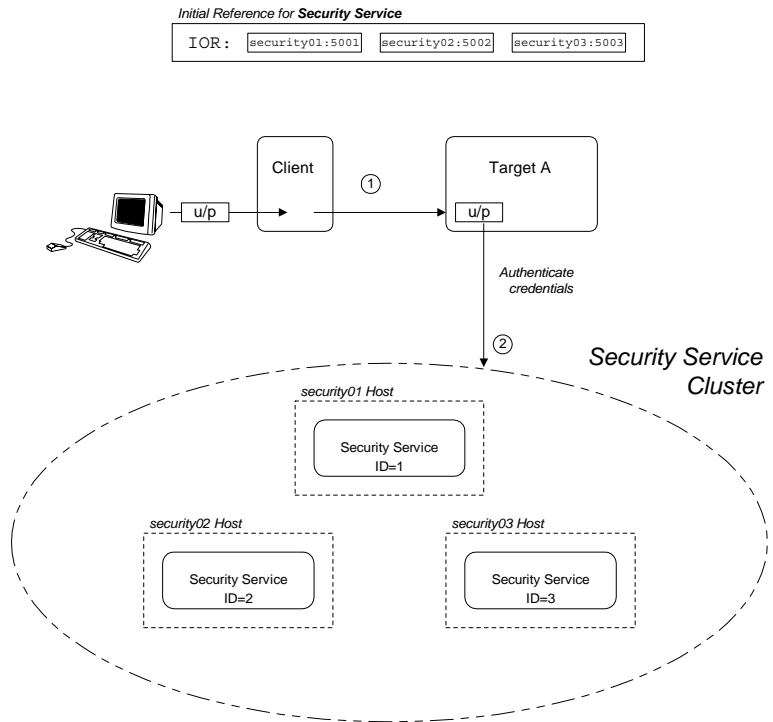

In this scenario, it is assumed that both the client and the target application are configured to perform *random load balancing* over the security services in the cluster (see “[Client Load Balancing](#)” on page 193 for details). Each of the security services in the cluster are configured for failover.



**Failover scenario steps**

The interaction of the client and target with the security service cluster shown in [Example 25 on page 186](#) can be described as follows:

| Stage | Description                                                                                                                                                                                                                                                                                                                                                               |
|-------|---------------------------------------------------------------------------------------------------------------------------------------------------------------------------------------------------------------------------------------------------------------------------------------------------------------------------------------------------------------------------|
| 1     | The client invokes an operation on the target, sending the username and password (u/p) credentials supplied by the user.                                                                                                                                                                                                                                                  |
| 2     | The target server checks the u/p credentials received from the client by sending an invocation to the security service cluster. If the target server already has an existing connection with a service in the cluster, it re-uses that connection. Otherwise, the target randomly picks an address from the list of addresses in the <code>IT_SecurityService</code> IOR. |

**Configuring the failover cluster**

To configure a cluster of security services that support failover, you need to edit a variety of configuration files, as follows:

- [Configuring the `is2.properties` file.](#)
- [Configuring the cluster properties file.](#)
- [Artix configuration for the first security service.](#)
- [Artix configuration for the second and third security services.](#)

**Configuring the `is2.properties` file**

Each instance of the Artix security service should have its own `is2.properties` file. Within each `is2.properties` file, you should set the following:

- `is2.current.server.id`—a unique ID for this Artix security service instance,
- `is2.cluster.properties.filename`—a shared cluster file.

For example, the first Artix security server instance from [Figure 25 on page 186](#) could be configured as follows:

```
# is2 Properties File, for Server ID=1
...
#####
## iSF federation related properties
#####
is2.current.server.id=1
is2.cluster.properties.filename=C:/is2_config/cluster.properties
...
```

The second and third Artix security services from [Figure 25 on page 186](#) should be configured similarly, except that the `is2.current.server.id` property should be set to 2 and 3 respectively.

### Configuring the cluster properties file

For the three-service cluster shown in [Figure 25 on page 186](#), you could configure the `cluster.properties` file as follows:

```
# Advertise the locations of the security services in the cluster.
com.iona.security.common.securityInstanceURL.1=corbaloc:it_iops:1.2@security01:5001/IT_Security
  Service
com.iona.security.common.securityInstanceURL.2=corbaloc:it_iops:1.2@security02:5002/IT_Security
  Service
com.iona.security.common.securityInstanceURL.3=corbaloc:it_iops:1.2@security03:5003/IT_Security
  Service
```

This file defines the following settings:

- `securityInstanceURL.ServerID`—advertises the location of a security service in the cluster. Normally, the most convenient way to set these values is to use the `corbaloc` URL format.

## Artix configuration for the first security service

**Example 43** shows the details of the Artix configuration for the first Artix security service in the cluster. To configure this security service to support failover, you must ensure that the security service's IOR contains a list addresses for all of the services in the cluster.

### **Example 43:** *Artix Security Service Configuration for Failover*

```

# Artix Configuration File
1 initial_references:IT_SecurityService:reference =
    "corbaloc:it_iops:1.2@security01:5001,it_iops:1.2@security0
    2:5002,it_iops:1.2@security03:5003/IT_SecurityService";

artix_services {
    ...
2    principal_sponsor:use_principal_sponsor = "true";
    principal_sponsor:auth_method_id = "pkcs12_file";
    principal_sponsor:auth_method_data = ["filename=PKCS12File",
    "password_file=CertPasswordFile"];

    policies:client_secure_invocation_policy:requires =
    ["Confidentiality", "EstablishTrustInTarget",
    "DetectMisordering", "DetectReplay", "Integrity"];

    policies:client_secure_invocation_policy:supports =
    ["Confidentiality", "EstablishTrustInClient",
    "EstablishTrustInTarget", "DetectMisordering",
    "DetectReplay", "Integrity"];

    security {
        ...
3        plugins:security:iiop_tls:addr_list = ["security01:5001",
    "+security02:5002", "+security03:5003"];
4        plugins:security:iiop_tls:host = "security01";
        plugins:security:iiop_tls:port = "5001";

5        plugins:java_server:system_properties =
    ["org.omg.CORBA.ORBClass=com.iona.corba.art.artimpl.ORBImpl",
    "org.omg.CORBA.ORBSingletonClass=com.iona.corba.art.artimpl.O
    RBSingleton", "is2.properties=SecurityPropertiesDir/security01
    .is2.properties", "java.endorsed.dirs=ArtixInstallDir/artix/Ve
    rsion/lib/endorsed"];
        policies:iiop_tls:target_secure_invocation_policy:requires
    = ["Integrity", "Confidentiality", "DetectReplay",
    "DetectMisordering", "EstablishTrustInClient"];

```

**Example 43:** *Artix Security Service Configuration for Failover*

```

    policies:iiop_tls:target_secure_invocation_policy:supports
= ["Integrity", "Confidentiality", "DetectReplay",
  "DetectMisordering", "EstablishTrustInTarget",
  "EstablishTrustInClient"];
    ...
  };
};

```

The preceding Artix configuration can be explained as follows:

1. The `IT_SecurityService` initial reference is read by Artix applications to locate the cluster of Artix security services. The initial reference is provided in the form of a `corbaloc` URL, which contains the addresses of all of the security services in the cluster. The `corbaloc` URL for the security service cluster has the following general form:

```
corbaloc:ListOfAddresses/IT_SecurityService
```

Where `ListOfAddresses` is a comma-separated list of protocol/address combinations. For each security service in the cluster, you need to make an entry in the comma-separated address list, as follows:

```
it_iiopts:1.2@Hostname:Port
```

Where `Hostname` is the host where the security service is running and `Port` is the IP port where the security service listens for connections.

2. The Artix security service picks up most of its SSL/TLS security settings from the `artix_services` scope. In particular, the default configuration of the security service uses the X.509 certificate specified by the `principal_sponsor` settings in this scope.
3. The `plugins:security:iiop_tls:addr_list` variable lists the addresses of all of the security services in the cluster.

The first entry, *not* prefixed by a `+` sign, specifies the address of the current security service instance. The remaining entries, prefixed by a `+` sign, specify the addresses of the other services in the cluster.

The `+` sign indicates that an entry affects only the contents of the generated IOR; it does not affect the security service's listening port.

4. The `plugins:security:iiop_tls:host` and `plugins:security:iiop_tls:port` settings specify the listening port for this security service instance.
5. Edit the `is2.properties` entry in the `plugins:java_server:system_properties` list to specify the location of the properties file used by this security service instance (see [“Configuring the `is2.properties` files” on page 183](#)). In this example, the properties file is called `security01.is2.properties`.

### Artix configuration for the second and third security services

The Artix configurations for the second and third security services in the cluster are similar to the configuration for the first one, except that the address details and the location of the `is2.properties` file must be modified appropriately.

For example, the second security service’s configuration would be modified as highlighted in the following example:

```
# Artix Configuration File
artix_services
{
  ...
  security_02 {
    ...
    plugins:security:iiop_tls:addr_list = ["security02:5002",
    "+security03:5003", "+security01:5001"];
    plugins:security:iiop_tls:host = "security02";
    plugins:security:iiop_tls:port = "5002";

    plugins:java_server:system_properties =
["org.omg.CORBA.ORBClass=com.iona.corba.art.artimpl.ORBImpl",
"org.omg.CORBA.ORBSingletonClass=com.iona.corba.art.artimpl.ORBSingleton", "is2.properties=SecurityPropertiesDir/security02.is2.properties", "java.endorsed.dirs=ArtixInstallDir/artix/Version/lib/endorsed"];
    ...
  };
};
```

Where the name of the configuration scope for the second security service is `artix_services.security_02`. The `plugins:security:iiop_tls:addr_list`, `plugins:security:iiop_tls:host`, and `plugins:security:iiop_tls:port`

configuration variables are modified so that the listening host and port are configured as `security02` and `5002` respectively. The `is2.properties` property is modified to point at the second security service's property file, `security02.is2.properties`.

---

## Client Load Balancing

---

### Overview

When you use a clustered security service, it is important to configure all of the secure applications in the system (clients and servers) to perform *client load balancing* (in this context, *client* means a client of the Artix security service and thus includes ordinary Artix servers as well). This ensures that the client load is evenly spread over all of the security services in the cluster. Client load balancing is disabled by default.

### Configuration for load balancing

[Example 44](#) shows an outline of the configuration for a client of a security service cluster. Such clients must be configured to use random load balancing to ensure that the load is spread evenly over the servers in the cluster. The settings highlighted in bold should be added to the application's configuration scope.

#### Example 44: Configuration for Client of a Security Service Cluster

```
# Artix Configuration File
...
load_balanced_app {
  ...
  initial_references:IT_SecurityService:reference =
"corbaloc:it_iops:1.2@security01:5001,it_iops:1.2@security0
2:5002,it_iops:1.2@security03:5003/IT_SecurityService";
  ...
  plugins:asp:enable_security_service_load_balancing = "true";
  policies:iop_tls:load_balancing_mechanism = "random";
  policies:asp:load_balancing_policy = "per-server";
};
```

### Security service corbaloc URL

The `IT_SecurityService` initial reference is specified as a corbaloc URL. The corbaloc URL includes the addresses for all of the security services in the cluster—see [“Artix configuration for the first security service” on page 189](#) for details of how to construct this corbaloc URL.

---

**Client load balancing mechanism**

The client load balancing mechanism is selected by setting the `policies:iiop_tls:load_balancing_mechanism` variable. Two mechanisms are supported, as follows:

- `random`—choose one of the addresses embedded in the IOR at random (this is the default).

**Note:** This is the only mechanism suitable for use in a deployed system.

- `sequential`—choose the first address embedded in the IOR, moving on to the next address in the list only if the previous address could not be reached.

In general, this mechanism is *not* recommended for deployed systems, because it usually results in all of the client applications connecting to the first cluster member. This mechanism can sometimes be useful for running tests (because the order in which addresses are chosen is deterministic).

---

**Client load balancing policy**

The client load balancing policy is selected by setting the `policies:asp:load_balancing_policy` variable. Two policies are supported, as follows:

- `per-server`—(*the default*) after selecting a particular security service from the cluster, the client remains connected to that security service instance.
- `per-request`—for each new request, the Artix security plug-in selects and connects to a new security service node (in accordance with the algorithm specified by `policies:iiop_tls:load_balancing_mechanism`).

**Note:** The process of re-establishing a secure connection with every new request imposes a significant performance overhead. Therefore, the `per-request` policy value is *not* recommended for most deployments.



**Note on the use of a corbaloc URL for the initial reference**

Specifying the security service IOR as a corbaloc URL has a subtle impact on the semantics of connection establishment, as detailed here.

Internally, Artix converts the corbaloc URL into a multi-profile IOR, where each profile contains a single IOR component with the address details for one security service. This contrasts with the structure of an IOR created directly by a security service, which consists of a single profile containing multiple IOR components. These IORs are treated slightly differently by Artix.

When an Artix program attempts to establish a connection to the security service using a corbaloc URL, the connection establishment is a two-step process:

1. Initially, Artix attempts to send a message to the *first* address appearing in the corbaloc URL. If that connection attempt fails, Artix moves on to the next address in the corbaloc URL, trying each address in sequence until a connection attempt succeeds.

**Note:** In this initial step, Artix always starts by attempting to contact the *first* address in the corbaloc URL. That is, Artix does not load-balance over multiple profiles in an IOR.

2. In reply to the message sent in step 1, the contacted security service sends back a *multi-component IOR*, containing the addresses of all the security services in the cluster (this exploits a feature of the GIOP protocol that allows CORBA servers to redirect incoming connections). When the Artix program receives the multi-component IOR, it makes a renewed attempt to contact a security service using the IOR it has just received.

Because Artix supports load balancing over the addresses in a multi-component IOR, the Artix security plug-in can now randomly pick one of the IOR components (assuming that the `random` load balancing mechanism is selected) and connect to the address contained therein.

---

# Additional Security Configuration

## Overview

---

This section describes how to configure optional features of the Artix security server, such as single sign-on and the authorization manager. These features can be combined with any iSF adapter type.

---

## In this section

This section contains the following subsections:

|                                                       |                          |
|-------------------------------------------------------|--------------------------|
| <a href="#">Configuring Single Sign-On Properties</a> | <a href="#">page 197</a> |
| <a href="#">Configuring the Log4J Logging</a>         | <a href="#">page 199</a> |

---

## Configuring Single Sign-On Properties

---

### Overview

The IONA security framework provides an optional *single sign-on* (SSO) feature. If you want to use SSO with your applications, you must configure the Artix security service as described in this section. SSO offers the following advantages:

- User credentials can easily be propagated between applications in the form of an SSO token.
  - Performance is optimized, because the authentication step only needs to be performed once within a distributed system.
  - Because the user's session is tracked centrally by the Artix security service, it is possible to impose timeouts on the user sessions and these timeouts are effective throughout the distributed system.
- 

### SSO tokens

The Artix security service generates an SSO token in response to an authentication operation. The SSO token is a compact key that the Artix security service uses to access a user's session details, which are stored in a cache.

---

### SSO properties

[Example 45](#) shows the iS2 properties needed for SSO:

#### Example 45: Single Sign-On Properties

```
# iS2 Properties File
...
#####
## Single Sign On Session Info
#####
1 is2.sso.enabled=yes
2 is2.sso.session.timeout=6000
3 is2.sso.session.idle.timeout=300
4 is2.sso.cache.size=10000
```

The SSO properties are described as follows:

1. Setting this property to `yes` enables single sign-on.
2. The SSO session timeout sets the lifesaving of SSO tokens, in units of seconds. Once the specified time interval elapses, the token expires.

3. The SSO session idle timeout sets the maximum length of time for which an SSO session can remain idle, in units of seconds. If the Artix security service registers no activity against a particular session for this amount of time, the session and its token expire.
4. The size of the SSO cache, in units of number of sessions.

---

## Configuring the Log4J Logging

---

### Overview

log4j is a third-party toolkit from the Jakarta project, <http://jakarta.apache.org/log4j>, that provides a flexible and efficient system for capturing logging messages from an application. Because the Artix security service's logging is based on log4j, it is possible to configure the output of iSF logging using a standard log4j properties file.

---

### log4j documentation

For complete log4j documentation, see the following Web page:  
<http://jakarta.apache.org/log4j/docs/documentation.html>

---

### Enabling log4j logging

To enable log4j logging, specify the location of the log4j properties file in the `is2.properties` file as follows:

```
# iS2 Properties File, for Server ID=1
...
#####
## log4j Logging
#####
log4j.configuration=C:/is2_config/log4j.properties
...
```

---

### Configuring the log4j properties file

The following example shows how to configure the log4j properties to perform basic logging. In this example, the lowest level of logging is switched on (DEBUG) and the output is sent to the console screen.

```
# log4j Properties File
log4j.rootCategory=DEBUG, A1

# A1 is set to be a ConsoleAppender.
log4j.appender.A1=org.apache.log4j.ConsoleAppender

# A1 uses PatternLayout.
log4j.appender.A1.layout=org.apache.log4j.PatternLayout
log4j.appender.A1.layout.ConversionPattern=%-4r [%t] %-5p %c %x
- %m%n
```

## Redirecting log4j to an Artix local log stream

You can optionally redirect the log4j log stream to the Artix local log stream. To enable this feature, set `plugins:security:log4j_to_local_log_stream` to `true` in the Artix configuration file.

For example, you can configure the Artix security service to send log4j logging to the local log stream, as follows:

```
# Artix Configuration File
security_service
{
  orb_plugins = ["local_log_stream", "iiop_profile", "giop",
               "iiop_tls"];
  plugins:security:log4j_to_local_log_stream = "true";

  # Log all log4j messages at level WARN and above
  event_log:filters = ["IT_SECURITY=WARN+ERROR+FATAL"];
  ...
};
```

You must ensure that the `local_log_stream` plug-in is present in the `orb_plugins` list and the log4j logging level can be set using the Artix event log filters mechanism. The `event_log:filters` setting in the preceding example is equivalent to setting `log4j.rootCategory=WARN` in the log4j properties file.

# Managing Users, Roles and Domains

*The Artix security service provides a variety of adapters that enable you to integrate the Artix Security Framework with third-party enterprise security products. This allows you to manage users and roles using a third-party enterprise security product.*

---

**In this chapter**

This chapter discusses the following topics:

|                                                    |                          |
|----------------------------------------------------|--------------------------|
| <a href="#">Introduction to Domains and Realms</a> | <a href="#">page 202</a> |
| <a href="#">Managing a File Security Domain</a>    | <a href="#">page 210</a> |
| <a href="#">Managing an LDAP Security Domain</a>   | <a href="#">page 214</a> |

---

# Introduction to Domains and Realms

## Overview

---

This section introduces the concepts of an Artix security domain and an Artix authorization realm, which are fundamental to the administration of the Artix Security Framework. Within an Artix security domain, you can create user accounts and within an Artix authorization realm you can assign roles to users.

---

## In this section

This section contains the following subsections:

|                                            |                          |
|--------------------------------------------|--------------------------|
| <a href="#">Artix security domains</a>     | <a href="#">page 203</a> |
| <a href="#">Artix Authorization Realms</a> | <a href="#">page 205</a> |



## Artix security domains

### Overview

This subsection introduces the concept of an Artix security domain.

### Domain architecture

Figure 26 shows the architecture of an Artix security domain. The Artix security domain is identified with an enterprise security service that plugs into the Artix security service through an iSF adapter. User data needed for authentication, such as username and password, are stored within the enterprise security service. The Artix security service provides a central access point to enable authentication within the Artix security domain.

**Figure 26:** Architecture of an Artix security domain

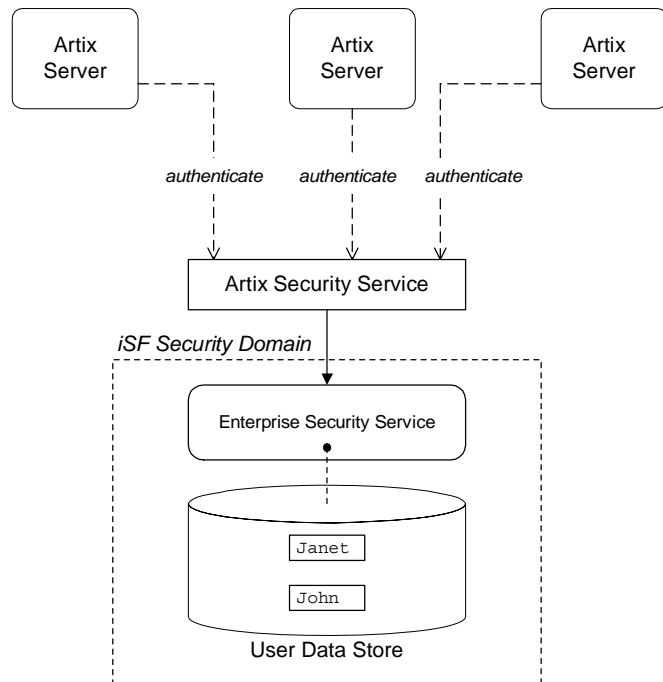

---

**Artix security domain**

An *Artix security domain* is a particular security system, or namespace within a security system, designated to authenticate a user.

Here are some specific examples of Artix security domains:

- LDAP security domain—authentication provided by an LDAP security backend, accessed through the Artix security service.

---

**Creating an Artix security domain**

Effectively, you create an Artix security domain by configuring the Artix security service to link to an enterprise security service through an iSF adapter (such as an LDAP adapter). The enterprise security service is the implementation of the Artix security domain.

---

**Creating a user account**

User account data is stored in a third-party enterprise security service. Hence, you should use the standard tools from the third-party enterprise security product to create a user account.

For a simple example, see [“Managing a File Security Domain” on page 210](#).

---

## Artix Authorization Realms

---

### Overview

This subsection introduces the concept of an Artix authorization realm and role-based access control, explaining how users, roles, realms, and servers are interrelated.

---

### Artix authorization realm

An *Artix authorization realm* is a collection of secured resources that share a common interpretation of role names. An authenticated user can have different roles in different realms. When using a resource in realm  $\mathbb{R}$ , only the user's roles in realm  $\mathbb{R}$  are applied to authorization decisions.

---

### Role-based access control

The Artix Security Framework supports a *role-based access control* (RBAC) authorization scheme. Under RBAC, authorization is a two step process, as follows:

1. User-to-role mapping—every user is associated with a set of roles in each realm (for example, `guest`, `administrator`, and so on, in a realm, `Engineering`). A user can belong to many different realms, having a different set of roles in each realm.

The user-to-role assignments are managed centrally by the Artix security service, which returns the set of realms and roles assigned to a user when required.

2. Role-to-permission mapping (or action-role mapping)—in the RBAC model, permissions are granted to *roles*, rather than directly to users. The role-to-permission mapping is performed locally by a server, using data stored in local access control list (ACL) files. For example, Artix servers in the Artix security framework use an XML action-role mapping file to control access to WSDL port types and operations.

## Servers and realms

From a server's perspective, an Artix authorization realm is a way of grouping servers with similar authorization requirements. [Figure 27](#) shows two Artix authorization realms, `Engineering` and `Finance`, each containing a collection of server applications.

**Figure 27:** Server View of Artix authorization realms

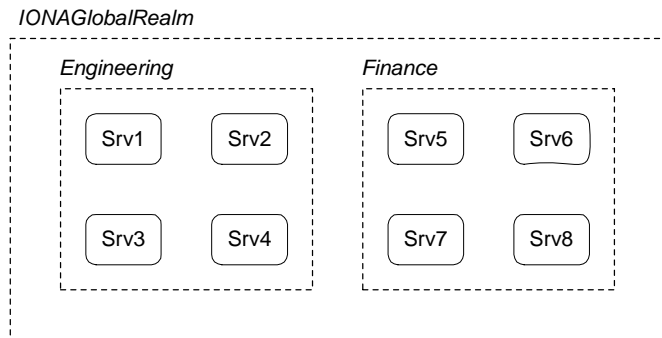

## Adding a server to a realm

To add an Artix server to a realm, add or modify the `plugins:asp:authorization_realm` configuration variable within the server's configuration scope (in the `artix.cfg` file).

For example, if your server's configuration is defined in the `my_server_scope` scope, you can set the Artix authorization realm to `Engineering` as follows:

```
# Artix configuration file
...
my_server_scope {
    plugins:asp:authorization_realm = "Engineering";
    ...
};
```

---

## Roles and realms

From the perspective of role-based authorization, an Artix authorization realm acts as a namespace for roles. For example, [Figure 28](#) shows two Artix authorization realms, `Engineering` and `Finance`, each associated with a set of roles.

**Figure 28:** *Role View of Artix authorization realms*

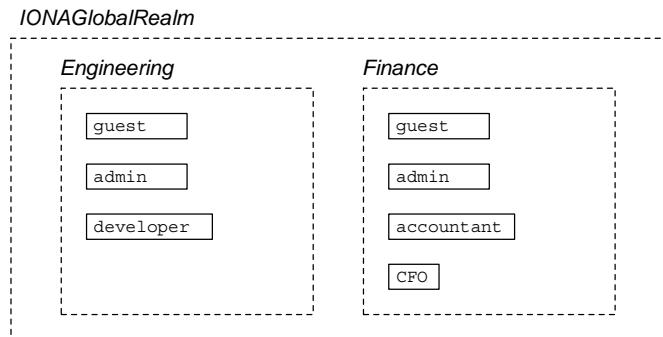

---

## Creating realms and roles

Realms and roles are usually administered from within the enterprise security system that is plugged into the Artix security service through an adapter. Not every enterprise security system supports realms and roles, however.

For example, in the case of a security file connected to a file adapter (a demonstration adapter provided by IONA), a realm or role is implicitly created whenever it is listed amongst a user's realms or roles.

**Assigning realms and roles to users**

The assignment of realms and roles to users is administered from within the enterprise security system that is plugged into the Artix security service. For example, [Figure 29](#) shows how two users, Janet and John, are assigned roles within the `Engineering` and `Finance` realms.

- Janet works in the engineering department as a developer, but occasionally logs on to the `Finance` realm with guest permissions.
- John works as an accountant in finance, but also has guest permissions with the `Engineering` realm.

**Figure 29:** Assignment of Realms and Roles to Users Janet and John

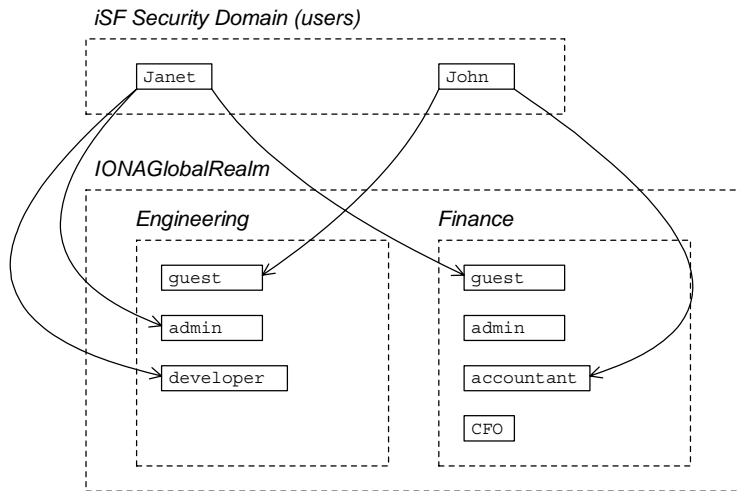

## Special realms and roles

---

The following special realms and roles are supported by the Artix Security Framework:

- `IONAGlobalRealm` realm—a special realm that encompasses every Artix authorization realm. Roles defined within the `IONAGlobalRealm` are valid within every Artix authorization realm.
- `UnauthenticatedUserRole`—a special role that can be used to specify actions accessible to an unauthenticated user (in an action-role mapping file). An unauthenticated user is a remote user without credentials (that is, where the client is not configured to send GSSUP credentials).

Actions mapped to the `UnauthenticatedUserRole` role are also accessible to authenticated users.

The `UnauthenticatedUserRole` can be used *only* in action-role mapping files.

---

# Managing a File Security Domain

---

## Overview

The file security domain is active if the Artix security service has been configured to use the iSF file adapter (see [“Configuring the File Adapter” on page 167](#)). The main purpose of the iSF file adapter is to provide a lightweight security domain for demonstration purposes and small deployments. A large deployed system, however, should use one of the other adapters (LDAP or custom) instead.

**Note:** The file adapter is a simple adapter that does *not* scale well for large enterprise applications. IONA supports the use of the file adapter in a production environment, but the number of users is limited to 200.

---

## Location of file

The location of the security information file is specified by the `com.iona.isp.adapter.file.param.filename` property in the Artix security service's `is2.properties` file.

---

## Example

[Example 46](#) is an extract from a sample security information file that shows you how to define users, realms, and roles in a file security domain.

### Example 46: Sample Security Information File for an iSF File Domain

```
<?xml version="1.0" encoding="utf-8" ?>
1 <ns:securityInfo xmlns:ns="urn:www-xmlbus-com:simple-security">
2   <users>
3     <user name="IONAAdmin" password="admin"
4       description="Default IONA admin user">
       <realm name="IONA" description="All IONA applications"/>
     </user>
     <user name="admin" password="admin" description="Old admin
user; will not have the same default privileges as
IONAAdmin.">
       <realm name="Corporate">
         <role name="Administrator"/>
       </realm>
     </user>
     <user name="alice" password="dost1234">
```



**Example 46:** Sample Security Information File for an iSF File Domain

```

5  <realm name="Financials"
      description="Financial Department">
      <role name="Manager" description="Department Manager" />
      <role name="Clerk"/>
    </realm>
  </user>
</user>
<user name="bob" password="dost1234">
  <realm name="Financials">
    <role name="Clerk"/>
  </realm>
</user>
</users>
</ns:securityInfo>

```

1. The `<ns:securityInfo>` tag can contain a nested `<users>` tag.
2. The `<users>` tag contains a sequence of `<user>` tags.
3. Each `<user>` tag defines a single user. The `<user>` tag's name and password attributes specify the user's username and password. Within the scope of the `<user>` tag, you can list the realms and roles with which the user is associated.
4. When a `<realm>` tag appears within the scope of a `<user>` tag, it implicitly defines a realm and specifies that the user belongs to this realm. A `<realm>` must have a `name` and can optionally have a `description` attribute.
5. A realm can optionally be associated with one or more roles by including `role` elements within the `<realm>` scope.

### Certificate-based authentication for the file adapter

When performing certificate-based authentication for the CORBA binding, the file adapter compares the certificate to be authenticated with a cached copy of the user's certificate.

To configure the file adapter to support X.509 certificate-based authentication for the CORBA binding, perform the following steps:

1. Cache a copy of each user's certificate, *CertFile.pem*, in a location that is accessible to the file adapter. The certificate must be in PEM format.
2. Specify which one of the fields from the certificate's subject DN should contain the user's name (user ID) by setting the `com.ionas.adapter.file.param.userIDInCert` property in the Artix security server's `is2.properties` file.

For example, to use the Common Name (CN) from the certificate's subject DN as the user name, add the following setting to the `is2.properties` file:

```
# Artix Security Server Properties File
com.ionas.adapter.file.param.userIDInCert=CN
```

3. In the security information file, make the following type of entry for each user with a certificate:

#### Example 47: File Adapter Entry for Certificate-Based Authentication

```
...
<user name="FieldFromSubjectDN" certificate="CertFile.pem"
  description="User certificate">
  <realm name="RealmName">
    ...
  </realm>
</user>
```

The user name, *FieldFromSubjectDN*, is derived from the user's certificate by extracting the relevant field from the subject DN of the X.509 certificate (for DN terminology, see [“ASN.1 and Distinguished Names” on page 517](#)). The field to extract from the subject DN is specified as described in the preceding step.

The `certificate` attribute specifies the location of this user's X.509 certificate, `CertFile.pem`.

---

# Managing an LDAP Security Domain

---

## Overview

The Lightweight Directory Access Protocol (LDAP) can serve as the basis of a database that stores users, groups, and roles. There are many implementations of LDAP and the Artix security service's LDAP adapter can integrate with any LDAP v.3 implementation.

*Please consult documentation from your third-party LDAP implementation for detailed instructions on how to administer users and roles within LDAP.*

---

## Configuring the LDAP adapter

A prerequisite for using LDAP within the Artix Security Framework is that the Artix security service be configured to use the LDAP adapter.

See [“Configuring the LDAP Adapter” on page 169](#).

---

## Certificate-based authentication for the LDAP adapter

When performing certificate-based authentication, the LDAP adapter compares the certificate to be authenticated with a cached copy of the user's certificate.

To configure the LDAP adapter to support X.509 certificate-based authentication, perform the following steps:

1. Cache a copy of each user's certificate, *CertFile.pem*, in a location that is accessible to the LDAP adapter. The certificate must be in PEM format.
2. The user's name, *CNfromSubjectDN*, is derived from the certificate by taking the Common Name (CN) from the subject DN of the X.509 certificate (for DN terminology, see [“ASN.1 and Distinguished Names” on page 517](#)).
3. Make (or modify) an entry in your LDAP database with the username, *CNfromSubjectDN*, and specify the location of the cached certificate.

# Managing Access Control Lists

*The Artix Security Framework defines access control lists (ACLs) for mapping roles to resources.*

---

**In this chapter**

This chapter discusses the following topics:

|                                             |                          |
|---------------------------------------------|--------------------------|
| <a href="#">Overview of Artix ACL Files</a> | <a href="#">page 216</a> |
| <a href="#">ACL File Format</a>             | <a href="#">page 217</a> |
| <a href="#">Generating ACL Files</a>        | <a href="#">page 220</a> |
| <a href="#">Deploying ACL Files</a>         | <a href="#">page 223</a> |

# Overview of Artix ACL Files

## Action-role mapping file

The action-role mapping file is an XML file that specifies which user roles have permission to perform specific actions on the server (that is, invoking specific WSDL operations).

## Deployment scenarios

Artix supports the following deployment scenario for ACL files:

- [Local ACL file](#).

## Local ACL file

In the local ACL file scenario, the action-role mapping file is stored on the same host as the server application (see [Figure 30](#)). The application obtains the action-role mapping data by reading the local ACL file.

**Figure 30:** *Locally Deployed Action-Role Mapping ACL File*

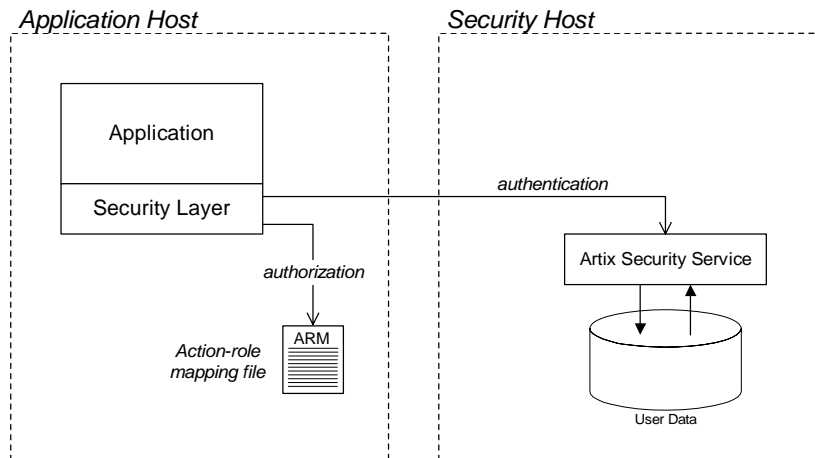

In this case, the location of the ACL file is specified by a setting in the application's `artix.cfg` file.

---

# ACL File Format

## Overview

This subsection explains how to configure the action-role mapping ACL file for Artix applications. Using an action-role mapping file, you can specify that access to WSDL operations is restricted to specific roles.

## Example WSDL

For example, consider how to set the operation permissions for the WSDL port type shown in [Example 48](#).

### Example 48: Sample WSDL for the ACL Example

```
<definitions name="HelloWorldService"
  targetNamespace="http://xmlbus.com/HelloWorld" ... >
  ...
  <portType name="HelloWorldPortType">
    <operation name="greetMe">
      <input message="tns:greetMe" name="greetMe"/>
      <output message="tns:greetMeResponse"
        name="greetMeResponse"/>
    </operation>
    <operation name="sayHi">
      <input message="tns:sayHi" name="sayHi"/>
      <output message="tns:sayHiResponse"
        name="sayHiResponse"/>
    </operation>
  </portType>
  ...
</definitions>
```

## Example action-role mapping

[Example 49](#) shows how you might configure an action-role mapping file for the `HelloWorldPortType` port type given in the preceding [Example 48](#) on [page 217](#).

### Example 49: Artix Action-Role Mapping Example

```
<?xml version="1.0" encoding="UTF-8"?>
<!DOCTYPE secure-system SYSTEM "actionrolemapping.dtd">
<secure-system>
1  <action-role-mapping>
2  <server-name>secure_artix.demos.hello_world</server-name>
```

**Example 49:** *Artix Action-Role Mapping Example*

```

3   <interface>
4   <name>http://xmlbus.com/HelloWorld:HelloWorldPortType</name>
5   <action-role>
      <action-name>sayHi</action-name>
      <role-name>IONAUserRole</role-name>
    </action-role>
      <action-name>greetMe</action-name>
      <role-name>IONAUserRole</role-name>
    </action-role>
  </interface>
</action-role-mapping>
</secure-system>

```

The preceding action-role mapping example can be explained as follows:

1. The `<action-role-mapping>` tag contains all of the permissions that apply to a particular server application.
2. The `<server-name>` tag specifies the ORB name that is used by the server in question. The value of this tag must match the ORB name exactly. The ORB name is usually passed to an Artix server as the value of the `-ORBname` command-line parameter.

**Note:** The ORB name also determines which configuration scopes are read by the server.

3. The `<interface>` tag contains all of the access permissions for one particular WSDL port type.
4. The `<name>` tag identifies a WSDL port type in the format `NamespaceURI:PortTypeName`. That is, the `PortTypeName` comes from a tag, `<portType name="PortTypeName">`, defined in the `NamespaceURI` namespace.

For example, in [Example 48 on page 217](#) the `<definitions>` tag specifies the `NamespaceURI` as `http://xmlbus.com/HelloWorld` and the `PortTypeName` is `HelloWorldPortType`. Hence, the port type name is identified as:

```
<name>http://xmlbus.com/HelloWorld:HelloWorldPortType</name>
```



5. The `sayHi` action name corresponds to the `sayHi` WSDL operation name in the `HelloWorldPortType` port type (from the `<operation name="sayHi">` tag).

---

### Action-role mapping DTD

The syntax of the action-role mapping file is defined by the action-role mapping DTD. See [“Action-Role Mapping DTD” on page 523](#) for details.

---

# Generating ACL Files

## Overview

Artix provides a command-line tool, `wSDLtoacl`, that enables you to generate the prototype of an ACL file directly from a WSDL contract. You can use the `wSDLtoacl` utility to assign a default role to all of the operations in WSDL contract. Alternatively, if you require more fine-grained control over the role assignments, you can define a *role-properties file*, which assigns roles to individual operations.

## WSDL-to-ACL utility

The `wSDLtoacl` command-line utility has the following syntax:

```
wSDLtoacl { -s server-name } WSDL-URL
[-i interface-name] [-r default-role-name]
[-d output-directory] [-o output-file]
[-props role-props-file] [-v] [-?]
```

### Required arguments:

- `-s server-name` The server's configuration scope from the Artix domain configuration file (the same value as specified to the `-ORBname` argument when the Artix server is started from the command line).  
For example, the `basic/hello_world_soap_http` demonstration uses the `demos.hello_world_soap_http` server name.
- `WSDL-URL` URL location of the WSDL file from which an ACL is generated.

### Optional arguments:

- `-i interface-name` Generates output for a specific WSDL port type, *interface-name*. If this option is omitted, output is generated for all of the port types in the WSDL file.
- `-r default-role-name` Specify the role name that will be assigned to all operations by default. Default is `IONAUserRole`.  
The default role-name is not used for operations listed in a role-properties file (see `-props`).

<code>-d output-directory</code>	Specify an output directory for the generated ACL file.
<code>-o output-file</code>	Specify the name of the generated ACL file. Default is <code>WSDLFileRoot-acl.xml</code> , where <code>WSDLFileRoot</code> is the root name of the WSDL file.
<code>-props role-props-file</code>	Specifies a file containing a list of <i>role-properties</i> , where a role-property associates an operation name with a list of roles. Each line of the role-properties file has the following format:  <i>OperationName = Role1, Role2, ...</i>
<code>-v</code>	Display version information for the utility.
<code>-?</code>	Display usage summary for the <code>wsdltoacl</code> utility.

**Example of generating an ACL file**

As example of how to generate an ACL file from WSDL, consider the `hello_world.wsdl` WSDL file for the `basic/hello_world_soap_http` demonstration, which is located in the following directory:

```
ArtixInstallDir/artix/Version/demos/basic/hello_world_soap_http/e
tc
```

The HelloWorld WSDL contract defines a single port type, `Greeter`, and two operations: `greetMe` and `sayHi`. The server name (that is, configuration scope) used by the HelloWorld server is `demos.hello_world_soap_http`.

**Sample role-properties file**

For the HelloWorld WSDL contract, you can define a role-properties file, `role_properties.txt`, that assigns the `FooUser` role to the `greetMe` operation and the `FooUser` and `BarUser` roles to the `sayHi` operation, as follows:

```
greetMe = FooUser
sayHi = FooUser, BarUser
```

**Sample generation command**

To generate an ACL file from the HelloWorld WSDL contract, using the `role_properties.txt` role-properties file, enter the following at a command-line prompt:

```
wsdltoacl -s demos.hello_world_soap_http hello_world.wsdl -props
role_properties.txt
```

**Sample ACL output**

The preceding `wsdltoacl` command generates an ACL file, `hello_world-acl.xml`, whose contents are shown in [Example 50](#).

**Example 50: ACL File Generated from HelloWorld WSDL Contract**

```
<?xml version="1.0" encoding="UTF-8"?>
<!DOCTYPE secure-system SYSTEM "actionrolemapping.dtd">
<secure-system>
  <action-role-mapping>
    <server-name>demos.hello_world_soap_http</server-name>
    <interface>
      <name>http://www.iona.com/hello_world_soap_http:Greeter</name>
      <action-role>
        <action-name>greetMe</action-name>
        <role-name>FooUser</role-name>
      </action-role>
      <action-role>
        <action-name>sayHi</action-name>
        <role-name>FooUser</role-name>
        <role-name>BarUser</role-name>
      </action-role>
    </interface>
  </action-role-mapping>
</secure-system>
```

---

# Deploying ACL Files

---

## Configuring a local ACL file

To configure an application to load action-role mapping data from a local file, do the following:

1. Save the ACL file together with the Artix action-role mapping DTD file in a convenient location. You can copy the DTD file, `actionrolemapping.dtd`, from the `ArtixInstallDir/artix/4.0/demos/security/full_security/etc` directory.
2. Edit the `artix-secure.cfg` configuration file, initializing the `plugins:is2_authorization:action_role_mapping` configuration variable with the ACL file location.

For example, an application with ORB name, `my_server_scope`, can be initialized to load a local ACL file, `security_admin/action_role_mapping.xml`, using the following configuration:

```
# Artix Configuration File
...
orb_plugins = ["xmlfile_log_stream", "iiop_profile", "giop",
              "iiop_tls", "soap", "http", "artix_security"];

my_server_scope {
    plugins:is2_authorization:action_role_mapping =
        "file:///security_admin/action_role_mapping.xml";
    ...
};
```



# Managing Certificates

*TLS authentication uses X.509 certificates—a common, secure and reliable method of authenticating your application objects. This chapter explains how you can create X.509 certificates that identify your Artix applications.*

---

**In this chapter**

This chapter contains the following sections:

<a href="#">What are X.509 Certificates?</a>	<a href="#">page 226</a>
<a href="#">Certification Authorities</a>	<a href="#">page 228</a>
<a href="#">Certificate Chaining</a>	<a href="#">page 231</a>
<a href="#">PKCS#12 Files</a>	<a href="#">page 233</a>
<a href="#">Creating Your Own Certificates</a>	<a href="#">page 235</a>
<a href="#">Generating a Certificate Revocation List</a>	<a href="#">page 242</a>
<a href="#">Deploying Certificates</a>	<a href="#">page 245</a>

---

# What are X.509 Certificates?

---

## Role of certificates

An X.509 certificate binds a name to a public key value. The role of the certificate is to associate a public key with the identity contained in the X.509 certificate.

---

## Integrity of the public key

Authentication of a secure application depends on the integrity of the public key value in the application's certificate. If an impostor replaced the public key with its own public key, it could impersonate the true application and gain access to secure data.

To prevent this form of attack, all certificates must be signed by a *certification authority (CA)*. A CA is a trusted node that confirms the integrity of the public key value in a certificate.

---

## Digital signatures

A CA signs a certificate by adding its *digital signature* to the certificate. A digital signature is a message encoded with the CA's private key. The CA's public key is made available to applications by distributing a certificate for the CA. Applications verify that certificates are validly signed by decoding the CA's digital signature with the CA's public key.

**WARNING:** Most of the demonstration certificates supplied with Artix are signed by the CA `cacert.pem`. This CA is completely insecure because anyone can access its private key. To secure your system, you must create new certificates signed by a trusted CA. This chapter describes the set of certificates required by an Artix application and shows you how to replace the default certificates.



### The contents of an X.509 certificate

---

An X.509 certificate contains information about the certificate subject and the certificate issuer (the CA that issued the certificate). A certificate is encoded in Abstract Syntax Notation One (ASN.1), a standard syntax for describing messages that can be sent or received on a network.

The role of a certificate is to associate an identity with a public key value. In more detail, a certificate includes:

- X.509 version information.
- A *serial number* that uniquely identifies the certificate.
- A *subject DN* that identifies the certificate owner.
- The *public key* associated with the subject.
- An *issuer DN* that identifies the CA that issued the certificate.
- The digital signature of the issuer.
- Information about the algorithm used to sign the certificate.
- Some optional X.509 v.3 extensions. For example, an extension exists that distinguishes between CA certificates and end-entity certificates.

### Distinguished names

---

A distinguished name (DN) is a general purpose X.500 identifier that is often used in the context of security.

See [“ASN.1 and Distinguished Names” on page 517](#) for more details about DNs.

---

# Certification Authorities

## Choice of CAs

---

A CA must be trusted to keep its private key secure. When setting up an Artix system, it is important to choose a suitable CA, make the CA certificate available to all applications, and then use the CA to sign certificates for your applications.

There are two types of CA you can use:

- A *commercial CA* is a company that signs certificates for many systems.
- A *private CA* is a trusted node that you set up and use to sign certificates for your system only.

## In this section

---

This section contains the following subsections:

<a href="#">Commercial Certification Authorities</a>	<a href="#">page 229</a>
<a href="#">Private Certification Authorities</a>	<a href="#">page 230</a>

---

## Commercial Certification Authorities

---

### Signing certificates

There are several commercial CAs available. The mechanism for signing a certificate using a commercial CA depends on which CA you choose.

---

### Advantages of commercial CAs

An advantage of commercial CAs is that they are often trusted by a large number of people. If your applications are designed to be available to systems external to your organization, use a commercial CA to sign your certificates. If your applications are for use within an internal network, a private CA might be appropriate.

---

### Criteria for choosing a CA

Before choosing a CA, you should consider the following criteria:

- What are the certificate-signing policies of the commercial CAs?
- Are your applications designed to be available on an internal network only?
- What are the potential costs of setting up a private CA?

---

## Private Certification Authorities

---

### Choosing a CA software package

If you wish to take responsibility for signing certificates for your system, set up a private CA. To set up a private CA, you require access to a software package that provides utilities for creating and signing certificates. Several packages of this type are available.

---

### OpenSSL software package

One software package that allows you to set up a private CA is OpenSSL, <http://www.openssl.org>. OpenSSL is derived from SSLeay, an implementation of SSL developed by Eric Young (eay@cryptsoft.com). Complete license information can be found in [“License Issues” on page 555](#). The OpenSSL package includes basic command line utilities for generating and signing certificates and these utilities are available with every installation of Artix. Complete documentation for the OpenSSL command line utilities is available from <http://www.openssl.org/docs>.

---

### Setting up a private CA using OpenSSL

For instructions on how to set up a private CA, see [“Creating Your Own Certificates” on page 235](#).

---

### Choosing a host for a private certification authority

Choosing a host is an important step in setting up a private CA. The level of security associated with the CA host determines the level of trust associated with certificates signed by the CA.

If you are setting up a CA for use in the development and testing of Artix applications, use any host that the application developers can access. However, when you create the CA certificate and private key, do not make the CA private key available on hosts where security-critical applications run.

---

### Security precautions

If you are setting up a CA to sign certificates for applications that you are going to deploy, make the CA host as secure as possible. For example, take the following precautions to secure your CA:

- Do not connect the CA to a network.
- Restrict all access to the CA to a limited set of trusted users.
- Protect the CA from radio-frequency surveillance using an RF-shield.

---

# Certificate Chaining

---

## Certificate chain

A *certificate chain* is a sequence of certificates, where each certificate in the chain is signed by the subsequent certificate.

---

## Self-signed certificate

The last certificate in the chain is normally a *self-signed certificate*—a certificate that signs itself.

---

## Example

[Figure 31](#) shows an example of a simple certificate chain.

**Figure 31:** A Certificate Chain of Depth 2

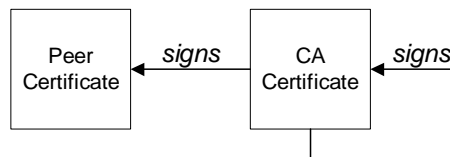

## Chain of trust

The purpose of certificate chain is to establish a chain of trust from a peer certificate to a trusted CA certificate. The CA vouches for the identity in the peer certificate by signing it. If the CA is one that you trust (indicated by the presence of a copy of the CA certificate in your root certificate directory), this implies you can trust the signed peer certificate as well.

---

**Certificates signed by multiple CAs**

A CA certificate can be signed by another CA. For example, an application certificate may be signed by the CA for the finance department of IONA Technologies, which in turn is signed by a self-signed commercial CA. [Figure 32](#) shows what this certificate chain looks like.

**Figure 32:** A Certificate Chain of Depth 3

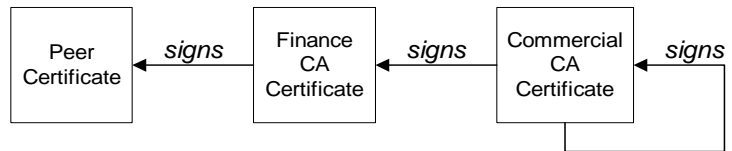

---

**Trusted CAs**

An application can accept a signed certificate if the CA certificate for any CA in the signing chain is available in the certificate file in the local root certificate directory.

See [“Deploying Trusted Certificate Authority Certificates” on page 248](#).

---

**Maximum chain length policy**

You can limit the length of certificate chains accepted by your CORBA applications, with the maximum chain length policy. You can set a value for the maximum length of a certificate chain with the `policies:iiop_tls:max_chain_length_policy` configuration variable for IIOP/TLS and the `policies:max_chain_length_policy` configuration variable for HTTPS respectively.

# PKCS#12 Files

## Overview

Figure 33 shows the typical elements in a PKCS#12 file.

**Figure 33:** Elements in a PKCS#12 File

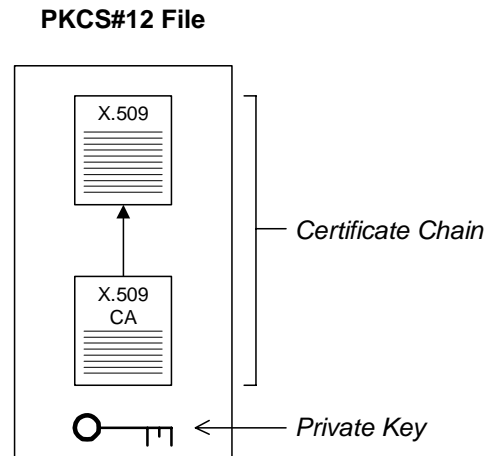

## Contents of a PKCS#12 file

A PKCS#12 file contains the following:

- An X.509 peer certificate (first in a chain).
- All the CA certificates in the certificate chain.
- A private key.

The file is encrypted with a pass phrase.

PKCS#12 is an industry-standard format and is used by browsers such as Netscape and Internet Explorer.

**Note:** The same pass phrase is used both for the encryption of the private key within the PKCS#12 file and for the encryption of the PKCS#12 file overall. This condition (same pass phrase) is not officially part of the PKCS#12 standard, but it is enforced by most Web browsers and by Artix.

---

**Creating a PKCS#12 file**

To create a PKCS#12 file, see [“Use the CA to Create Signed Certificates” on page 239](#).

---

**Viewing a PKCS#12 file**

To view a PKCS#12 file, *CertName.p12*:

```
openssl pkcs12 -in CertName.p12
```

---

**Importing and exporting PKCS#12 files**

The generated PKCS#12 files can be imported into browsers such as IE or Netscape. Exported PKCS#12 files from these browsers can be used in Artix.

**Note:** Use OpenSSL v0.9.2 or later; Internet Explorer 5.0 or later; Netscape 4.7 or later.



---

# Creating Your Own Certificates

---

**Overview**

This section describes the steps involved in setting up a CA and signing certificates.

---

**OpenSSL utilities**

The steps described in this section are based on the OpenSSL command-line utilities from the OpenSSL project, <http://www.openssl.org>—see “[OpenSSL Utilities](#)” on [page 527](#). Further documentation of the OpenSSL command-line utilities can be obtained from <http://www.openssl.org/docs>.

---

**Sample CA directory structure**

For the purposes of illustration, the CA database is assumed to have the following directory structure:

`X509CA/ca`

`X509CA/certs`

`X509CA/newcerts`

`X509CA/crl`

Where `X509CA` is the parent directory of the CA database.

---

**In this section**

This section contains the following subsections:

<a href="#">Set Up Your Own CA</a>	<a href="#">page 236</a>
<a href="#">Use the CA to Create Signed Certificates</a>	<a href="#">page 239</a>

---

## Set Up Your Own CA

---

### Substeps to perform

This section describes how to set up your own private CA. Before setting up a CA for a real deployment, read the additional notes in [“Choosing a host for a private certification authority” on page 230](#).

To set up your own CA, perform the following substeps:

- [Step 1—Add the bin directory to your PATH](#)
  - [Step 2—Create the CA directory hierarchy](#)
  - [Step 3—Copy and edit the openssl.cnf file](#)
  - [Step 4—Initialize the CA database](#)
  - [Step 5—Create a self-signed CA certificate and private key](#)
- 

### Step 1—Add the bin directory to your PATH

On the secure CA host, add the OpenSSL `bin` directory to your path:

#### Windows

```
> set PATH=OpenSSLDir\bin;%PATH%
```

#### UNIX

```
% PATH=OpenSSLDir/bin:$PATH; export PATH
```

This step makes the `openssl` utility available from the command line.

---

### Step 2—Create the CA directory hierarchy

Create a new directory, `x509CA`, to hold the new CA. This directory will be used to hold all of the files associated with the CA. Under the `x509CA` directory, create the following hierarchy of directories:

```
x509CA/ca  
x509CA/certs  
x509CA/newcerts  
x509CA/crl
```

---

### Step 3—Copy and edit the openssl.cnf file

Copy the sample `openssl.cnf` from your OpenSSL installation to the `x509CA` directory.

Edit the `openssl.cnf` to reflect the directory structure of the `x509CA` directory and to identify the files used by the new CA.

Edit the [CA\_default] section of the openssl.cnf file to make it look like the following:

```
#####
[ CA_default ]

dir           = X509CA           # Where CA files are kept
certs        = $dir/certs       # Where issued certs are kept
crl_dir      = $dir/crl         # Where the issued crl are kept
database     = $dir/index.txt   # Database index file
new_certs_dir = $dir/newcerts   # Default place for new certs

certificate  = $dir/ca/new_ca.pem # The CA certificate
serial       = $dir/serial       # The current serial number
crl          = $dir/crl.pem      # The current CRL
private_key  = $dir/ca/new_ca_pk.pem # The private key
RANDFILE     = $dir/ca/.rand    # Private random number file

x509_extensions = usr_cert     # The extensions to add to the cert
...
```

You might like to edit other details of the OpenSSL configuration at this point—for more details, see [“The OpenSSL Configuration File” on page 537](#).

#### Step 4—Initialize the CA database

In the *X509CA* directory, initialize two files, *serial* and *index.txt*.

##### Windows

```
> echo 01 > serial
```

To create an empty file, *index.txt*, in Windows start a Windows Notepad at the command line in the *X509CA* directory, as follows:

```
> notepad index.txt
```

In response to the dialog box with the text, Cannot find the text.txt file. Do you want to create a new file?, click Yes, and close Notepad.

##### UNIX

```
% echo "01" > serial
% touch index.txt
```

These files are used by the CA to maintain its database of certificate files.

**Note:** The *index.txt* file must initially be completely empty, not even containing white space.

**Step 5—Create a self-signed CA certificate and private key**

Create a new self-signed CA certificate and private key:

```
openssl req -x509 -new -config
    X509CA/openssl.cnf -days 365 -out X509CA/ca/new_ca.pem
    -keyout X509CA/ca/new_ca_pk.pem
```

The command prompts you for a pass phrase for the CA private key and details of the CA distinguished name:

```
Using configuration from X509CA/openssl.cnf
Generating a 512 bit RSA private key
...+++++
.+++++
writing new private key to 'new_ca_pk.pem'
Enter PEM pass phrase:
Verifying password - Enter PEM pass phrase:
-----
You are about to be asked to enter information that will be
incorporated into your certificate request.
What you are about to enter is what is called a Distinguished
Name or a DN. There are quite a few fields but you can leave
some blank. For some fields there will be a default value,
If you enter '.', the field will be left blank.
-----
Country Name (2 letter code) []:IE
State or Province Name (full name) []:Co. Dublin
Locality Name (eg, city) []:Dublin
Organization Name (eg, company) []:IONA Technologies PLC
Organizational Unit Name (eg, section) []:Finance
Common Name (eg, YOUR name) []:Gordon Brown
Email Address []:gbrown@iona.com
```

**Note:** The security of the CA depends on the security of the private key file and private key pass phrase used in this step.

You should ensure that the file names and location of the CA certificate and private key, `new_ca.pem` and `new_ca_pk.pem`, are the same as the values specified in `openssl.cnf` (see the preceding step).

You are now ready to sign certificates with your CA.

---

## Use the CA to Create Signed Certificates

---

### Substeps to perform

If you have set up a private CA, as described in “[Set Up Your Own CA](#)” on [page 236](#), you are now ready to create and sign your own certificates.

To create and sign a certificate in PKCS#12 format, *CertName.p12*, perform the following substeps:

- [Step 1—Add the bin directory to your PATH](#)
- [Step 2—Create a certificate signing request](#)
- [Step 3—Sign the CSR](#)
- [Step 4—Concatenate the files](#)
- [Step 5—Create a PKCS#12 file](#)
- [Step 6—Repeat steps as required](#)

---

### Step 1—Add the bin directory to your PATH

If you have not already done so, add the OpenSSL `bin` directory to your path:

#### Windows

```
> set PATH=OpenSSLDir\bin;%PATH%
```

#### UNIX

```
% PATH=OpenSSLDir/bin:$PATH; export PATH
```

This step makes the `openssl` utility available from the command line.

---

### Step 2—Create a certificate signing request

Create a new certificate signing request (CSR) for the *CertName.p12* certificate:

```
openssl req -new -config X509CA/openssl.cnf  
-days 365 -out X509CA/certs/CertName_csr.pem -keyout  
X509CA/certs/CertName_pk.pem
```

This command prompts you for a pass phrase for the certificate's private key and information about the certificate's distinguished name.

Some of the entries in the CSR distinguished name must match the values in the CA certificate (specified in the CA Policy section of the `openssl.cnf` file). The default `openssl.cnf` file requires the following entries to match:

- Country Name
- State or Province Name
- Organization Name

The Common Name must be distinct for every certificate generated by OpenSSL.

```
Using configuration from X509CA/openssl.cnf
Generating a 512 bit RSA private key
.++++
.++++
writing new private key to 'X509CA/certs/CertName_pk.pem'
Enter PEM pass phrase:
Verifying password - Enter PEM pass phrase:
-----
You are about to be asked to enter information that will be
incorporated into your certificate request.
What you are about to enter is what is called a Distinguished
Name or a DN. There are quite a few fields but you can leave
some blank. For some fields there will be a default value,
If you enter '.', the field will be left blank.
-----
Country Name (2 letter code) []:IE
State or Province Name (full name) []:Co. Dublin
Locality Name (eg, city) []:Dublin
Organization Name (eg, company) []:IONA Technologies PLC
Organizational Unit Name (eg, section) []:Systems
Common Name (eg, YOUR name) []:Artix
Email Address []:info@iona.com

Please enter the following 'extra' attributes
to be sent with your certificate request
A challenge password []:password
An optional company name []:IONA
```

### Step 3—Sign the CSR

Sign the CSR using your CA:

```
openssl ca -config X509CA/openssl.cnf -days 365 -in
X509CA/certs/CertName_csr.pem -out X509CA/certs/CertName.pem
```

This command requires the pass phrase for the private key associated with the new\_ca.pem CA certificate:

```
Using configuration from X509CA/openssl.cnf
Enter PEM pass phrase:
Check that the request matches the signature
Signature ok
The Subjects Distinguished Name is as follows
countryName          :PRINTABLE:'IE'
stateOrProvinceName  :PRINTABLE:'Co. Dublin'
localityName         :PRINTABLE:'Dublin'
organizationName     :PRINTABLE:'IONA Technologies PLC'
```

```

organizationalUnitName:PRINTABLE:'Systems'
commonName             :PRINTABLE:'Bank Server Certificate'
emailAddress           :IA5STRING:'info@iona.com'
Certificate is to be certified until May 24 13:06:57 2000 GMT (365
days)
Sign the certificate? [y/n]:y
1 out of 1 certificate requests certified, commit? [y/n]y
Write out database with 1 new entries
Data Base Updated

```

To sign the certificate successfully, you must enter the CA private key pass phrase—see [“Set Up Your Own CA” on page 236](#).

---

#### Step 4—Concatenate the files

Concatenate the CA certificate file, *CertName* certificate file, and *CertName\_pk.pem* private key file as follows:

##### Windows

```

copy X509CA\ca\new_ca.pem +
    X509CA\certs\CertName.pem +
    X509CA\certs\CertName_pk.pem
    X509CA\certs\CertName_list.pem

```

##### UNIX

```

cat X509CA/ca/new_ca.pem
    X509CA/certs/CertName.pem
    X509CA/certs/CertName_pk.pem >
    X509CA/certs/CertName_list.pem

```

---

#### Step 5—Create a PKCS#12 file

Create a PKCS#12 file from the *CertName\_list.pem* file as follows:

```

openssl pkcs12 -export -in X509CA/certs/CertName_list.pem -out
    X509CA/certs/CertName.p12 -name "New cert"

```

---

#### Step 6—Repeat steps as required

Repeat steps 2 to 5, creating a complete set of certificates for your system. A minimum set of Artix certificates must include a set of certificates for the secure Artix services.

---

# Generating a Certificate Revocation List

---

## Overview

This section describes how to use an OpenSSL CA to generate a *certificate revocation list* (CRL). A CRL is a list of X.509 certificates that are no longer considered to be valid. You can deploy a CRL file to a secure application, so that the application automatically rejects certificates that appear in the list. For details about how to deploy a CRL file, see [“Specifying a Certificate Revocation List” on page 272](#).

---

## Relationship between a CA and a CRL

In order to generate a certificate revocation list, it is not sufficient simply to assemble a list of certificates that you would like to revoke. The CA, just as it is responsible for creating and signing certificates, is also responsible for revoking certificates. When you decide to revoke a certificate, you must inform the CA, which records this fact in its database.

After revoking certificates, you can ask the CA to generate a signed certificate revocation list.

---

## Steps to revoke certificates

To generate a certificate revocation list, perform the following steps:

- [Step 1—Add the OpenSSL bin directory to your path.](#)
  - [Step 2—Revoke certificates.](#)
  - [Step 3—Generate the CRL file.](#)
  - [Step 4—Check the CRL file.](#)
- 

## Step 1—Add the OpenSSL bin directory to your path

On the secure CA host, add the OpenSSL `bin` directory to your path:

### Windows

```
> set PATH=OpenSSLDir\bin;%PATH%
```

### UNIX

```
% PATH=OpenSSLDir/bin:$PATH; export PATH
```

This step makes the `openssl` utility available from the command line.



**Step 2—Revoke certificates**

To add a certificate, *CertName.pem*, to the revocation list, enter the following command:

```
openssl ca -config X509CA/openssl.cnf -revoke
          X509CA/certs/CertName.pem
```

The command prompts you for the CA pass phrase and then revokes the certificate:

```
Using configuration from openssl.cnf
Loading 'screen' into random state - done
Enter pass phrase for C:/temp/artix_40/X509CA/ca/new_ca_pk.pem:
DEBUG[load_index]: unique_subject = "yes"
Adding Entry with serial number 02 to DB for
          /C=IE/ST=Dublin/O=IONA/CN=bad_guy
Revoking Certificate 02.
Data Base Updated
```

Repeat this step as many times as necessary to add certificates to the CA's revocation list.

**Note:** If you get the following error while attempting to revoke a certificate:

```
unable to rename C:/temp/artix_40/X509CA/index.txt to
          C:/temp/artix_40/X509CA/index.txt.old
reason: File exists
```

Simply delete *index.txt.old* and then try the command again.

**Step 3—Generate the CRL file**

To generate a PEM file, *crl.pem*, containing the CA's complete certificate revocation list, enter the following command:

```
openssl ca -config X509CA/openssl.cnf -gencrl -out crl/crl.pem
```

The command prompts you for the CA pass phrase and then generates the *crl.pem* file:

```
Using configuration from openssl.cnf
Loading 'screen' into random state - done
Enter pass phrase for C:/temp/artix_40/X509CA/ca/new_ca_pk.pem:
DEBUG[load_index]: unique_subject = "yes"
```

**Step 4—Check the CRL file**

Check the contents of the CRL file by converting it to plain text format, using the following command:

```
openssl crl -in crl/crl.pem -text
```

For a single revoked certificate with serial number 02 (that is, the second certificate in the OpenSSL CA's database), the output of this command would look something like the following:

```
Certificate Revocation List (CRL):
  Version 1 (0x0)
  Signature Algorithm: md5WithRSAEncryption
  Issuer: /C=IE/ST=Dublin/O=IONA/CN=CA_for_CRL
  Last Update: Feb 15 10:47:40 2006 GMT
  Next Update: Mar 15 10:47:40 2006 GMT
Revoked Certificates:
  Serial Number: 02
  Revocation Date: Feb 15 10:45:05 2006 GMT
  Signature Algorithm: md5WithRSAEncryption
  69:3e:55:8a:20:a0:57:d2:36:79:f0:34:bb:73:65:1e:1c:a9:
  40:35:8d:c4:e6:b9:77:fd:2b:1f:a8:26:0c:7a:fb:30:67:7f:
  6a:13:74:58:b9:e2:88:e7:ad:c5:d2:62:48:6b:1e:f6:10:0d:
  45:cc:11:cb:6b:48:28:e2:78:ad:f0:cf:fd:d6:57:78:f2:aa:
  19:8b:bc:62:79:9b:90:f7:18:ba:96:dc:7b:a5:b4:d5:bf:0f:
  e8:5e:71:89:4b:38:8c:f8:75:17:dd:ba:74:f1:01:e0:48:d0:
  e4:f4:dd:ea:47:32:8b:70:5e:1d:9a:4a:88:41:ba:bf:b2:39:
  ce:32
-----BEGIN X509 CRL-----
MIIBHTCBhzANBgkqhkiG9w0BAQQFADBCMqswCQYDVQQGEwJJRTEPMA0GA1UECBMG
RHVibGluMQ0wCwYDVQQKEwRJT05EMRMwEQYDVQQDFApDQV9mb3JfQ1JMFw0wNjAy
MTUxMDQ3NDBaFw0wNjAzMTUxMDQ3NDBaMBQwEgIBAhcNMDYwMjE1MTA0NTA1WjAN
BgkqhkiG9w0BAQQFAAQBgQBpPlWIKBX0jZ58DS7c2UeHKLANY3E5r13/SsfqCYM
evswZ39qE3RYueKI563F0mJIax72EA1FzBHLa0go4nit8M/91ld48qoZi7xieZuQ
9xi6ltx7pbTVvw/oXnGJSziM+HUX3bp08QHgSNDk9N3qRzKLcF4dmkqIQbq/sjnO
Mg==
-----END X509 CRL-----
```

---

# Deploying Certificates

**Overview**

---

This section provides an overview of deploying X.509 certificates in a typical secure Artix system, with detailed instructions on how to deploy certificates for different parts of the Artix system.

---

**In this section**

This section contains the following subsections:

<a href="#">Overview of Certificate Deployment</a>	<a href="#">page 246</a>
<a href="#">Deploying Trusted Certificate Authority Certificates</a>	<a href="#">page 248</a>
<a href="#">Deploying Application Certificates</a>	<a href="#">page 254</a>

---

## Overview of Certificate Deployment

---

### Overview

Because the HTTPS and IIOP/TLS transports use different security mechanisms, it is necessary to deploy certificates for each of these transports independently, as follows:

- [Certificate deployment for HTTPS](#).
- [Certificate deployment for IIOP/TLS](#).

---

### Certificate deployment for HTTPS

Certificates used by the HTTPS transport must be in PKCS#12 format. To specify certificates for the HTTPS transport, you can either edit the Artix configuration file or edit your application's WSDL contract.

**Note:** Versions of Artix prior to 3.0 required certificates for the HTTPS transport to be in Privacy Enhanced Mail (PEM) format. For instructions on how to convert PEM certificates to PKCS#12 format, see [“Converting legacy certificates” on page 254](#).

---

### Certificate deployment for IIOP/TLS

Certificates used by the IIOP/TLS transport must be in PKCS#12 format. To specify certificates for the IIOP/TLS transport, you must edit the Artix configuration file.

---

### Order of precedence

Certificate deployment settings can be specified in a number of different ways. The order of precedence, from the highest to the lowest, is as follows:

- *Programmatic settings*—you can use Artix contexts to specify security settings. See [“Programming Authentication” on page 359](#) for details.
- *WSDL settings (HTTPS only)*—Artix enables you to specify security settings using attributes of the `http-conf:client` and `http-conf:server` elements.
- `plugins:at_http` settings in the Artix configuration file (HTTPS only).
- `principal_sponsor`, `policies`, `policies:iiop_tls`, and `policies:https` settings in the Artix configuration file.
- *Default settings*—if no settings are explicitly provided, Artix falls back on the defaults.

**Sample deployment directory structure**

---

For the purposes of illustration, the examples in this section deploy certificates into the following sample directory structure:

```
X509Deploy/trusted_ca_lists
```

```
X509Deploy/certs
```

Where *X509Deploy* is the parent directory for the deployed certificates.

---

# Deploying Trusted Certificate Authority Certificates

---

## Overview

This section how to deploy trusted root CA certificates for Artix applications.

---

## CA certificate format

CA certificates must be provided in Privacy Enhanced Mail (PEM) format.

The PEM format is a proprietary format. You can use the Openssl command-line tools to convert certificates to and from the PEM format. For example, to convert a CA file, `ca.der`, from DER format to PEM format, use the following `openssl` command:

```
openssl crl -inform DER -outform PEM -in ca.der -out ca.pem
```

Where `ca.pem` is the converted PEM format file.

---

## How to deploy a trusted CA list

In the current version of Artix, the procedure for deploying trusted CA certificates depends on the type of transport, as follows:

- [Deployment for the HTTPS and IIOP/TLS transports.](#)
  - [Alternative HTTPS deployment in the Artix configuration file.](#)
  - [Alternative HTTPS deployment by configuring the WSDL contract.](#)
- 

## Deployment for the HTTPS and IIOP/TLS transports

To deploy one or more trusted root CAs for the HTTPS and IIOP/TLS transport, perform the following steps (the procedure for client and server applications is the same):

1. Assemble the collection of trusted CA certificates that you want to deploy. The trusted CA certificates could be obtained from public CAs or private CAs (for details of how to generate your own CA certificates, see [“Set Up Your Own CA” on page 236](#)). The trusted CA certificates should be in PEM format. All you need are the certificates themselves—the private keys and passwords are not required.
2. Organize the CA certificates into a collection of CA list files. For example, you might create three CA list files as follows:

```
X509Deploy/trusted_ca_lists/ca_list01.pem
```

```
X509Deploy/trusted_ca_lists/ca_list02.pem
```

```
X509Deploy/trusted_ca_lists/ca_list03.pem
```

Each CA list file consists of a concatenated list of CA certificates in PEM format. A CA list file can be created using a simple file

concatenation operation. For example, if you have two CA certificate files, `ca_cert01.pem` and `ca_cert02.pem`, you could combine them into a single CA list file, `ca_list01.pem`, with the following command:

#### Windows

```
copy X509CA\ca\ca_cert01.pem +
    X509CA\ca\ca_cert02.pem
    X509Deploy\trusted_ca_lists\ca_list01.pem
```

#### UNIX

```
cat X509CA/ca/ca_cert01.pem X509CA/ca/ca_cert02.pem >>
    X509Deploy/trusted_ca_lists/ca_list01.pem
```

The CA certificates are organized as lists as a convenient way of grouping related CA certificates together.

3. Edit the `artix.cfg` file to specify the locations of the CA list files to be used by your application. The `artix.cfg` file is located in the following directory:

```
ArtixInstallDir/artix/Version/etc/domains
```

To specify the CA list files, go to your application's configuration scope in the `artix.cfg` file and edit the value of the `policies:iiop_tls:trusted_ca_list_policy` configuration variable for the IIOPTLS transport and the `policies:https:trusted_ca_list_policy` configuration variable for the HTTPS transport.

For example, if your application picks up its configuration from the `SecureAppScope` configuration scope and you want to include the CA certificates from the `ca_list01.pem` and `ca_list02.pem` files, edit the `artix.cfg` file as follows:

```
# Artix configuration file.
...
SecureAppScope {
    ...
    policies:iioptls:trusted_ca_list_policy =
["X509Deploy/trusted_ca_lists/ca_list01.pem",
"X509Deploy/trusted_ca_lists/ca_list02.pem"];

    policies:https:trusted_ca_list_policy =
["X509Deploy/trusted_ca_lists/ca_list01.pem",
"X509Deploy/trusted_ca_lists/ca_list02.pem"];
    ...
};
```

The directory containing the trusted CA certificate lists (for example, `X509Deploy/trusted_ca_lists/`) should be a secure directory.

**Note:** If an application supports authentication of a peer, that is a client supports `EstablishTrustInTarget`, then a file containing trusted CA certificates *must* be provided. If not, a `NO_RESOURCES` exception is raised.



---

**Alternative HTTPS deployment in the Artix configuration file**

Alternatively, the `at_http` plug-in supports configuration variables that let you specify the CA certificate list separately for the client role and the server role.

Edit the Artix configuration file by adding (or modifying) the `plugins:at_http:client:trusted_root_certificates` and `plugins:at_http:server:trusted_root_certificates` configuration variables, as follows:

```
secure_app {
  plugins:at_http:client:use_secure_sockets="true";
  plugins:at_http:client:trusted_root_certificates =
  "X509Deploy/trusted_ca_lists/ca_list01.pem";
  ...
  plugins:at_http:server:trusted_root_certificates =
  "X509Deploy/trusted_ca_lists/ca_list02.pem";
  ...
};
```

**Note:** These settings take precedence over the `policies:https:trusted_ca_list_policy` variable.

---

**Alternative HTTPS deployment by configuring the WSDL contract**

Alternatively, the HTTPS transport lets you specify the location of a CA list file by configuring the WSDL contract. An advantage of this approach is that it allows you to specify trusted CA lists independently for each port.

**Note:** The settings in the WSDL contract take precedence over the settings in the `artix.cfg` file.

Edit the WSDL contract to specify the location of the CA list file. The details of this step depend on whether you are deploying a trusted CA list on the client side or on the server side.

**Client side**

Edit the client's copy of the WSDL contract by adding (or modifying) the `TrustedRootCertificates` attribute in the `<http-conf:client>` tag. For example, to specify `X509CA/ca/ca_list01.pem` as the client's trusted CA certificate list, modify the client's WSDL contract as follows:

```
<definitions
xmlns:http="http://schemas.iona.com/transport/http"
xmlns:http-conf="http://schemas.iona.com/transport/http/configu
ration" ... >
...
<service name="...">
  <port binding="...">
    <http-conf:client ...
      TrustedRootCertificates="X509CA/ca/ca_list01.pem"
      ... />
    ...
  </port>
</service>
```

**WARNING:** If you include security settings in the WSDL contract and you have loaded the WSDL publish plug-in, it is recommended that you configure the WSDL publishing service to be secure. See [“Publishing WSDL Securely” on page 123](#).

**Server side**

Edit the server's copy of the WSDL contract by adding (or modifying) the `TrustedRootCertificates` attribute in the `<http-conf:server>` tag. For example, to specify `X509CA/ca/ca_list01.pem` as the server's trusted CA certificate list, modify the server's WSDL contract as follows:

```
<definitions
xmlns:http="http://schemas.iona.com/transport/http"
xmlns:http-conf="http://schemas.iona.com/transport/http/configu
ration" ... >
...
<service name="...">
  <port binding="...">
    ...
    <http-conf:server ...
      TrustedRootCertificates="X509CA/ca/ca_list01.pem"
      ... />
    </port>
</service>
```

**WARNING:** If you include security settings in the WSDL contract and you have loaded the WSDL publish plug-in, it is recommended that you configure the WSDL publishing service to be secure. See [“Publishing WSDL Securely”](#) on page 123.

---

## Deploying Application Certificates

---

### Overview

This section describes how to deploy an Artix application's own certificate. In the current version of Artix, the procedure for deploying application certificates depends on the type of transport, as follows:

- [Deployment for the HTTPS and IIOP/TLS transports.](#)
  - [Alternative HTTPS deployment in the Artix configuration file.](#)
  - [Alternative HTTPS deployment by configuring the WSDL contract.](#)
- 

### Converting legacy certificates

For both the HTTPS and the IIOP/TLS transports, certificates must be supplied in PKCS#12 format. If you have any legacy certificates in PEM format, you can convert them to PKCS#12 format using the `openssl` command-line utility, as follows:

#### Windows

Given the CA signing certificate, `CACert.pem`, the application certificate, `Cert.pem`, and its private key, `PrivKey.pem`, enter the following at a Windows command prompt:

```
> copy CACert.pem + Cert.pem + PrivKey.pem CertList.pem
> openssl pkcs12 -export -in CertList.pem -out Cert.p12
```

#### UNIX

Given the CA signing certificate, `CACert.pem`, the application certificate, `Cert.pem`, and its private key, `PrivKey.pem`, enter the following at a UNIX command prompt:

```
> cat CACert.pem Cert.pem PrivKey.pem > CertList.pem
> openssl pkcs12 -export -in CertList.pem -out Cert.p12
```

**Note:** The `openssl` utility is not included in the Artix distribution. To obtain the `openssl` utility, go to [www.openssl.org](http://www.openssl.org) and download the latest version of the OpenSSL software.

## Deployment for the HTTPS and IIO/TLS transports

To deploy an Artix application's own certificate, *CertName.p12*, for the HTTPS and IIO/TLS transports, perform the following steps:

1. Copy the application certificate, *CertName.p12*, to the certificates directory—for example, *X509Deploy/certs/applications*—on the deployment host.

The certificates directory should be a secure directory that is accessible only to administrators and other privileged users.

2. Edit the *artix.cfg* configuration file (usually *ArtixInstallDir/artix/Version/etc/domains/artix.cfg*). Given that your application picks up its configuration from the *SecureAppScope* scope, change the principal sponsor configuration to specify the *CertName.p12* certificate, as follows:

```
# Artix configuration file
...
SecureAppScope {
    ...
    principal_sponsor:use_principal_sponsor = "true";
    principal_sponsor:auth_method_id = "pkcs12_file";
    principal_sponsor:auth_method_data =
        ["filename=X509Deploy/certs/applications/CertName.p12"];
};
```

3. By default, the application will prompt the user for the certificate pass phrase as it starts up. To choose another option for providing the pass phrase, see [“Providing a Certificate Pass Phrase” on page 269](#).

### Alternative HTTPS deployment in the Artix configuration file

Alternatively, the `at_http` plug-in supports configuration variables that let you specify the location of an application's PKCS#12 separately for the client role and the server role.

Edit the Artix configuration file by adding (or modifying) the following highlighted configuration variables, as follows:

```
secure_app {
    plugins:at_http:client:use_secure_sockets="true";
    // Client certificate settings.
    plugins:at_http:client:client_certificate =
    "X509Deploy/certs/applications/CertName.p12";
    plugins:at_http:client:client_private_key_password =
    "MyKeyPassword";
    ...
    // Server certificate settings.
    plugins:at_http:server:server_certificate =
    "X509Deploy/certs/applications/CertName.p12";
    plugins:at_http:server:server_private_key_password =
    "MyKeyPassword";
    ...
};
```

**Note:** These settings take precedence over the `principal_sponsor:https` settings.

### Alternative HTTPS deployment by configuring the WSDL contract

Alternatively, the HTTPS transport lets you specify the location of an application's PKCS#12 file by configuring the WSDL contract.

**Note:** The settings in the WSDL contract take precedence over the settings in the `artix.cfg` file.

Edit the WSDL contract to specify the location of the application's PKCS#12 file. The details of this step depend on whether you are deploying a trusted CA list on the client side or on the server side:

#### Client side

Edit the client's copy of the WSDL contract by adding (or modifying) the following highlighted attributes in the `<http-conf:client>` tag:

```
<definitions
xmlns:http="http://schemas.ionas.com/transport/http"
xmlns:http-conf="http://schemas.ionas.com/transport/http/configuration" ... >
...
<service name="...">
  <port binding="...">
    <soap:address ...>
      <http-conf:client UseSecureSockets="true"
ClientCertificate="X509Deploy/certs/applications/CertName.p12"
ClientPrivateKeyPassword="MyKeyPassword"
TrustedRootCertificates="RootCertPath"
... />
    </port>
  </service>
```

**WARNING:** If you include security settings in the WSDL contract and you have loaded the WSDL publish plug-in, it is recommended that you configure the WSDL publishing service to be secure. See [“Publishing WSDL Securely” on page 123](#).

**Server side**

Edit the server's copy of the WSDL contract by adding (or modifying) the following highlighted attributes in the `<http-conf:server>` tag:

```
<definitions
xmlns:http="http://schemas.ionas.com/transport/http"
xmlns:http-conf="http://schemas.ionas.com/transport/http/configuration" ... >
...
<service name="...">
  <port binding="...">
    <soap:address ...>
      <http-conf:server UseSecureSockets="true"
ServerCertificate="X509Deploy/certs/applications/CertName.p12"
ServerPrivateKeyPassword="MyKeyPassword"
TrustedRootCertificates="RootCertPath"
... />
    </port>
  </service>
```

**Note:** Because the private key passwords in the WSDL contracts appear in plaintext form, you must ensure that the WSDL contract files themselves are not readable/writable by every user. Use the operating system to restrict read/write access to trusted users only.

Additionally, to avoid revealing the server's security configuration to clients, you should remove the `<http-conf:server>` tag from the client copy of the WSDL contract.

**WARNING:** If you include security settings in the WSDL contract and you have loaded the WSDL publish plug-in, it is recommended that you configure the WSDL publishing service to be secure. See [“Publishing WSDL Securely” on page 123](#).



# Configuring HTTPS and IIOP/TLS Authentication

*This chapter describes how to configure HTTPS and IIOP/TLS authentication requirements for Artix applications.*

---

## **In this chapter**

This chapter discusses the following topics:

<a href="#">Requiring Authentication</a>	<a href="#">page 260</a>
<a href="#">Specifying Trusted CA Certificates</a>	<a href="#">page 267</a>
<a href="#">Specifying an Application's Own Certificate</a>	<a href="#">page 268</a>
<a href="#">Providing a Certificate Pass Phrase</a>	<a href="#">page 269</a>
<a href="#">Specifying a Certificate Revocation List</a>	<a href="#">page 272</a>
<a href="#">Advanced Configuration Options</a>	<a href="#">page 274</a>

# Requiring Authentication

---

## Overview

This section discusses how to specify the kind of authentication required, whether mutual or target-only.

---

## In this section

There are two possible arrangements for a TLS secure association:

<a href="#">Target-Only Authentication</a>	<a href="#">page 261</a>
<a href="#">Mutual Authentication</a>	<a href="#">page 264</a>

# Target-Only Authentication

## Overview

When an application is configured for target-only authentication, the target authenticates itself to the client but the client is not authentic to the target object—see [Figure 34](#).

**Figure 34:** *Target Authentication Only*

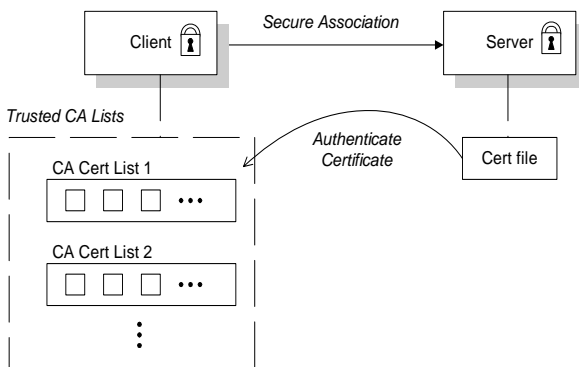

## Security handshake

Prior to running the application, the client and server should be set up as follows:

- A certificate chain is associated with the server—the certificate chain is provided in the form of a PKCS#12 file (for HTTPS and IIOP/TLS). See [“Specifying an Application’s Own Certificate” on page 268](#).
- One or more lists of trusted certification authorities (CA) are made available to the client—see [“Deploying Trusted Certificate Authority Certificates” on page 248](#).

During the security handshake, the server sends its certificate chain to the client—see [Figure 34](#). The client then searches its trusted CA lists to find a CA certificate that matches one of the CA certificates in the server’s certificate chain.

## HTTPS example

The following extract from an `artix.cfg` configuration file shows the target-only configuration of an Artix client application, `bank_client`, and an Artix server application, `bank_server`, where the transport type is HTTPS.

```
# Artix Configuration File
...
policies:mechanism_policy:protocol_version = "SSL_V3";
policies:mechanism_policy:ciphersuites =
    ["RSA_WITH_RC4_128_SHA", "RSA_WITH_RC4_128_MD5"];

bank_server {
    policies:target_secure_invocation_policy:requires =
        ["Confidentiality", "Integrity", "DetectReplay",
        "DetectMisordering"];
    policies:target_secure_invocation_policy:supports =
        ["Confidentiality", "Integrity", "DetectReplay",
        "DetectMisordering", "EstablishTrustInTarget"];
    ...
};

bank_client {
    ...
    policies:client_secure_invocation_policy:requires =
        ["Confidentiality", "EstablishTrustInTarget"];
    policies:client_secure_invocation_policy:supports =
        ["Confidentiality", "Integrity", "DetectReplay",
        "DetectMisordering", "EstablishTrustInTarget"];
};
```

## IIOPTLS example

The following extract from an `artix.cfg` configuration file shows the target-only configuration of an Artix client application, `bank_client`, and an Artix server application, `bank_server`, where the transport type is IIOPTLS.

```
# Artix Configuration File
...
policies:iioptls:mechanism_policy:protocol_version = "SSL_V3";
policies:iioptls:mechanism_policy:ciphersuites =
    ["RSA_WITH_RC4_128_SHA", "RSA_WITH_RC4_128_MD5"];

bank_server {
    policies:iioptls:target_secure_invocation_policy:requires =
        ["Confidentiality", "Integrity", "DetectReplay",
         "DetectMisordering"];
    policies:iioptls:target_secure_invocation_policy:supports =
        ["Confidentiality", "Integrity", "DetectReplay",
         "DetectMisordering", "EstablishTrustInTarget"];
    ...
};

bank_client {
    ...
    policies:iioptls:client_secure_invocation_policy:requires =
        ["Confidentiality", "EstablishTrustInTarget"];
    policies:iioptls:client_secure_invocation_policy:supports =
        ["Confidentiality", "Integrity", "DetectReplay",
         "DetectMisordering", "EstablishTrustInTarget"];
};
```

# Mutual Authentication

## Overview

When an application is configured for mutual authentication, the target authenticates itself to the client and the client authenticates itself to the target. This scenario is illustrated in Figure 35. In this case, the server and the client each require an X.509 certificate for the security handshake.

**Figure 35:** *Mutual Authentication*

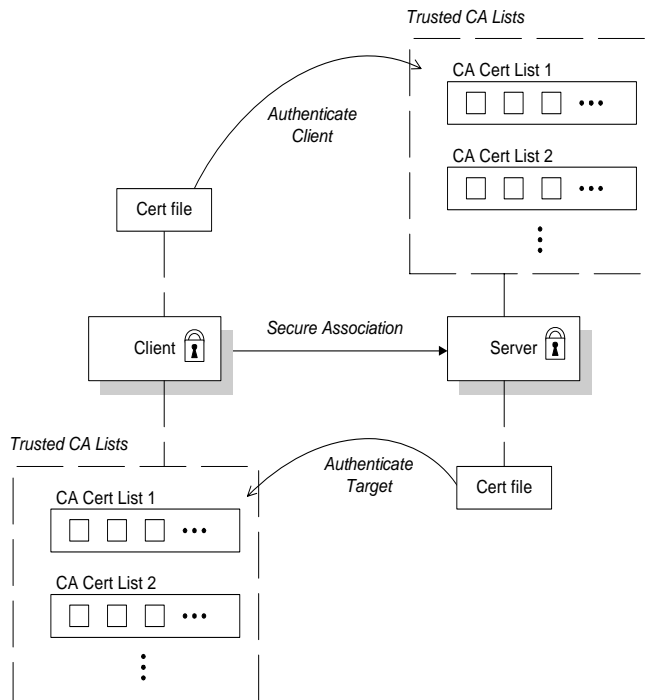

## Security handshake

Prior to running the application, the client and server should be set up as follows:

- Both client and server have an associated certificate chain (PKCS#12 file)—see [“Specifying an Application’s Own Certificate” on page 268](#).
- Both client and server are configured with lists of trusted certification authorities (CA)—see [“Deploying Trusted Certificate Authority Certificates” on page 248](#).

During the security handshake, the server sends its certificate chain to the client, and the client sends its certificate chain to the server—see [Figure 34](#).

## HTTPS example

The following sample extract from an `artix.cfg` configuration file shows the configuration for mutual authentication of a client application, `secure_client_with_cert`, and a server application, `secure_server_enforce_client_auth`, where the transport type is HTTPS.

```
# Artix Configuration File
...
policies:mechanism_policy:protocol_version = "SSL_V3";
policies:mechanism_policy:ciphersuites =
    ["RSA_WITH_RC4_128_SHA", "RSA_WITH_RC4_128_MD5"];

secure_server_enforce_client_auth
{
    policies:target_secure_invocation_policy:requires =
        ["EstablishTrustInClient", "Confidentiality", "Integrity",
        "DetectReplay", "DetectMisordering"];
    policies:target_secure_invocation_policy:supports =
        ["EstablishTrustInClient", "Confidentiality", "Integrity",
        "DetectReplay", "DetectMisordering",
        "EstablishTrustInTarget"];
    ...
};

secure_client_with_cert
{
    policies:client_secure_invocation_policy:requires =
        ["Confidentiality", "EstablishTrustInTarget"];
    policies:client_secure_invocation_policy:supports =
        ["Confidentiality", "Integrity", "DetectReplay",
        "DetectMisordering", "EstablishTrustInClient",
        "EstablishTrustInTarget"];
    ...
}
```

```
};
```

## IIOP/TLS example

The following sample extract from an `artix.cfg` configuration file shows the configuration for mutual authentication of a client application, `secure_client_with_cert`, and a server application, `secure_server_enforce_client_auth`, where the transport type is IIOP/TLS.

```
# Artix Configuration File
...
policies:iiop_tls:mechanism_policy:protocol_version = "SSL_V3";
policies:iiop_tls:mechanism_policy:ciphersuites =
  ["RSA_WITH_RC4_128_SHA", "RSA_WITH_RC4_128_MD5"];

secure_server_enforce_client_auth
{
  policies:iiop_tls:target_secure_invocation_policy:requires =
    ["EstablishTrustInClient", "Confidentiality", "Integrity",
     "DetectReplay", "DetectMisordering"];
  policies:iiop_tls:target_secure_invocation_policy:supports =
    ["EstablishTrustInClient", "Confidentiality", "Integrity",
     "DetectReplay", "DetectMisordering",
     "EstablishTrustInTarget"];
  ...
};

secure_client_with_cert
{
  policies:iiop_tls:client_secure_invocation_policy:requires =
    ["Confidentiality", "EstablishTrustInTarget"];
  policies:iiop_tls:client_secure_invocation_policy:supports =
    ["Confidentiality", "Integrity", "DetectReplay",
     "DetectMisordering", "EstablishTrustInClient",
     "EstablishTrustInTarget"];
  ...
};
```



---

# Specifying Trusted CA Certificates

---

## Overview

When an application receives an X.509 certificate during an SSL/TLS handshake, the application decides whether or not to trust the received certificate by checking whether the issuer CA is one of a pre-defined set of trusted CA certificates. If the received X.509 certificate is validly signed by one of the application's trusted CA certificates, the certificate is deemed trustworthy; otherwise, it is rejected.

---

## Which applications need to specify trusted CA certificates?

Any application that is likely to receive an X.509 certificate as part of an HTTPS or IIOP/TLS handshake must specify a list of trusted CA certificates. For example, this includes the following types of application:

- All IIOP/TLS or HTTPS clients.
  - Any IIOP/TLS or HTTPS servers that support mutual authentication.
- 

## How to deploy trusted CA certificates

For more details about how to deploy trusted CA certificates, see the following references:

- [“Deploying Trusted Certificate Authority Certificates” on page 248.](#)

---

# Specifying an Application's Own Certificate

---

## Overview

To enable an Artix application to identify itself, it must be associated with an X.509 certificate. The X.509 certificate is needed during an SSL/TLS handshake, where it is used to authenticate the application to its peers. The method you use to specify the certificate depends on the type of application:

- *Security unaware*—configuration only,

This section discusses how to specify a certificate by configuration only.

---

## How to deploy an application certificate

For details about how to deploy an application's own certificate, see the following reference:

- [“Deploying Application Certificates” on page 254.](#)

---

# Providing a Certificate Pass Phrase

**Overview**

---

If an application is configured to have an X.509 certificate, it is necessary to provide a pass phrase as the application starts up. There are various ways of providing the certificate pass phrase, depending on the particular type of transport used.

---

**In this section**

This section contains the following subsections:

<a href="#">Certificate Pass Phrase for HTTPS and IIOP/TLS</a>
----------------------------------------------------------------

<a href="#">page 270</a>
--------------------------

---

## Certificate Pass Phrase for HTTPS and IIOP/TLS

---

### Overview

Once you have specified a PKCS#12 certificate, you must also provide its *pass phrase*. The pass phrase is needed to decrypt the certificate's private key (which is used during the TLS security handshake to prove the certificate's authenticity).

For the HTTPS and IIOP/TLS transports, the pass phrase can be provided in one of the following ways:

- [From a dialog prompt.](#)
- [In a password file.](#)
- [Directly in configuration.](#)

---

### From a dialog prompt

If the pass phrase is not specified in any other way, Artix will prompt the user for the pass phrase as the application starts up. This approach is suitable for persistent (that is, manually-launched) servers.

#### C++ Applications

When a C++ application starts up, the user is prompted for the pass phrase at the command line as follows:

```
Initializing the ORB
Enter password :
```

---

### In a password file

The pass phrase is stored in a password file whose location is specified in the `principal_sponsor:auth_method_data` configuration variable using the `password_file` option. In the following example, the `SecureApp` scope configures the principal sponsor as follows:

```
# Artix Configuration File
SecureApp {
  ...
  principal_sponsor:use_principal_sponsor = "true";
  principal_sponsor:auth_method_id = "pkcs12_file";
  principal_sponsor:auth_method_data =
    ["filename=X509Deploy/certs/administrator.p12",
     "password_file=X509Deploy/certs/administrator.pwf"];
  ...
};
```

In this example, the pass phrase for the `bank_server.p12` certificate is stored in the `administrator.pwf` file, which contains the following pass phrase:

```
administratorpass
```

**WARNING:** Because the password file stores the pass phrase in plain text, the password file should not be readable by anyone except the administrator. For greater security, you could supply the pass phrase from a dialog prompt instead.

### Directly in configuration

For a PKCS #12 file, the pass phrase can be specified directly in the `principal_sponsor:auth_method_data` configuration variable using the `password` option. For example, the `bank_server` demonstration configures the principal sponsor as follows:

```
# Artix Configuration File
bank_server {
    ...
    principal_sponsor:use_principal_sponsor = "true";
    principal_sponsor:auth_method_id = "pkcs12_file";
    principal_sponsor:auth_method_data =
        ["filename=ASPInstallDir\asp\6.0\etc\tls\x509\certs\demos\bank_server.p12", "password=bankserverpass"];
};
```

In this example, the pass phrase for the `bank_server.p12` certificate is `bankserverpass`.

**WARNING:** Storing the pass phrase directly in configuration is not recommended for deployed systems. The pass phrase is in plain text and could be read by anyone.

---

# Specifying a Certificate Revocation List

---

## Overview

Occasionally, it can happen that the security of an X.509 certificate is compromised or you might want to invalidate a certificate, because the owner of the certificate no longer enjoys the same security privileges as before. In either of these cases, it is useful to generate and deploy a *certificate revocation list* (CRL). A CRL is a list of X.509 certificates that are no longer valid. When you deploy a CRL file to a secure application, the application automatically rejects the certificates that appear in the list.

## Configuring certificate revocation

**Example 51** shows how to configure an application to use a CRL file. For an application that uses the `secure_artix.my_secure_app` configuration scope, add `cert_validator` to the list of ORB plug-ins and set the `plugins:cert_validator:crl_file_path` variable to the location of the CRL file.

### **Example 51:** *Configuration of a Certificate Revocation List*

```
# Artix Configuration File
secure_artix {
  ...
  my_secure_app {
    orb_plugins = [ ... , "cert_validator"];
    plugins:cert_validator:crl_file_path = "CRLDir/crl.pem";
  };
};
```

**Note:** The specified CRL file can be empty, but it must exist. Otherwise, every certificate would be rejected.

## Format of the CRL file

The CRL file must be in a PEM format.

## Sources of CRL files

You can obtain a CRL file from one of the following sources:

- [Commercial CAs](#).
- [OpenSSL CA](#).

---

**Commercial CAs**

If you use a commercial CA to manage your certificates, simply ask the CA to generate the CRL file for you.

It is unlikely, however, that the CA will provide the CRL file in the requisite PEM format (the PEM format is proprietary to the OpenSSL product). To convert a CRL file, `crl.der`, from DER format to PEM format, use the following `openssl` command:

```
openssl crl -inform DER -outform PEM -in crl.der -out crl.pem
```

Where `crl.pem` is the converted PEM format file.

---

**OpenSSL CA**

If you use the OpenSSL product to manage a custom CA, you can generate a CRL file by following the instructions in [“Generating a Certificate Revocation List” on page 242](#).

---

**Creating an aggregate CRL file**

If you need to revoke certificates from more than one CA, you can create an aggregate CRL file simply by concatenating the CRL files from each CA.

For example, if you have a CRL file generated by a commercial CA, `commercial_crl.pem`, and another CRL file generated by a home-grown OpenSSL CA, `openssl_crl.pem`, you can combine these into a single CRL file as follows:

**Windows**

```
copy commercial_crl.pem + openssl_crl.pem crl.pem
```

**UNIX**

```
cat commercial_crl.pem openssl_crl.pem > crl.pem
```

---

# Advanced Configuration Options

## Overview

---

For added security, the HTTPS and IIOp/TLS transports allows you to apply extra conditions on certificates. Before reading this section you might find it helpful to consult [“Managing Certificates” on page 225](#), which provides some background information on the structure of certificates.

---

## In this section

This section discusses the following advanced IIOp/TLS configuration options:

<a href="#">Setting a Maximum Certificate Chain Length</a>	<a href="#">page 275</a>
<a href="#">Applying Constraints to Certificates</a>	<a href="#">page 276</a>



---

## Setting a Maximum Certificate Chain Length

---

### Max chain length policy

You can use the maximum chain length policy to enforce the maximum length of certificate chains presented by a peer during handshaking.

A certificate chain is made up of a root CA at the top, an application certificate at the bottom and any number of CA intermediaries in between. The length that this policy applies to is the (inclusive) length of the chain from the application certificate presented to the first signer in the chain that appears in the list of trusted CA's (as specified in the `TrustedCAListPolicy`).

---

### Example

For example, a chain length of 2 mandates that the certificate of the immediate signer of the peer application certificate presented must appear in the list of trusted CA certificates.

---

### Configuration variable

You can specify the maximum length of certificate chains used in maximum chain length policy with the `policies:iiop_tls:max_chain_length_policy` and `policies:max_chain_length_policy` configuration variable. For example:

```
policies:iiop_tls:max_chain_length_policy = "4";
```

---

### Default value

The default value is 2 (that is, the application certificate and its signer, where the signer must appear in the list of trusted CA's).

---

## Applying Constraints to Certificates

---

### Certificate constraints policy

You can use the certificate constraints policy to apply constraints to peer X.509 certificates. These conditions are applied to the owner's distinguished name (DN) on the first certificate (peer certificate) of the received certificate chain. Distinguished names are made up of a number of distinct fields, the most common being Organization Unit (OU) and Common Name (CN).

---

### Configuration variable

You can specify a list of constraints to be used by the certificate constraints policy through the `policies:iiop_tls:certificate_constraints_policy` or `policies:certificate_constraints_policy` configuration variable. For example:

```
policies:iiop_tls:certificate_constraints_policy =
    ["CN=Johnny*,OU=[unit1|IT_SSL],O=IONA,C=Ireland,ST=Dublin,L=Earth",
     "CN=Paul*,OU=SSLTEAM,O=IONA,C=Ireland,ST=Dublin,L=Earth",
     "CN=TheOmnipotentOne"];
```

---

### Constraint language

These are the special characters and their meanings in the constraint list:

*	Matches any text. For example: an* matches ant and anger, but not aunt
[ ]	Grouping symbols.
	Choice symbol. For example: OU=[unit1 IT_SSL] signifies that if the OU is unit1 or IT_SSL, the certificate is acceptable.
=, !=	Signify equality and inequality respectively.

**Example**

This is an example list of constraints:

```
policies:iiop_tls:certificate_constraints_policy = [
    "OU=[unit1|IT_SSL],CN=Steve*,L=Dublin",
    "OU=IT_ART*,OU!=IT_ARTtesters,CN=[Jan|Donal],ST=
    Boston" ];
```

This constraint list specifies that a certificate is deemed acceptable if and only if it satisfies one or more of the constraint patterns:

```
If
    The OU is unit1 or IT_SSL
    And
    The CN begins with the text Steve
    And
    The location is Dublin
Then the certificate is acceptable
Else (moving on to the second constraint)
If
    The OU begins with the text IT_ART but isn't IT_ARTtesters
    And
    The common name is either Donal or Jan
    And
    The State is Boston
Then the certificate is acceptable
Otherwise the certificate is unacceptable.
```

The language is like a boolean OR, trying the constraints defined in each line until the certificate satisfies one of the constraints. Only if the certificate fails all constraints is the certificate deemed invalid.

Note that this setting can be sensitive about white space used within it. For example, "CN =" might not be recognized, where "CN=" is recognized.

**Distinguished names**

For more information on distinguished names, see [“ASN.1 and Distinguished Names” on page 517](#).



# Configuring HTTPS and IIOP/TLS Secure Associations

*The Artix HTTPS and IIOP/TLS transport layers offer additional functionality that enables you to customize client-server connections by specifying secure invocation policies and security mechanism policies.*

---

**In this chapter**

This chapter discusses the following topics:

<a href="#">Overview of Secure Associations</a>	<a href="#">page 280</a>
<a href="#">Setting Association Options</a>	<a href="#">page 282</a>
<a href="#">Specifying Cipher Suites</a>	<a href="#">page 295</a>
<a href="#">Caching Sessions</a>	<a href="#">page 305</a>

---

# Overview of Secure Associations

---

## Secure association

A *secure association* is a term that has its origins in the CORBA Security Service and refers to any link between a client and a server that enables invocations to be transmitted securely. In the present context, a secure association is a HTTPS connection or an IIOP/TLS connection augmented by a collection of security policies that govern the behavior of the connection.

---

## TLS session

A *TLS session* is the TLS implementation of a secure client-server association. The TLS session is accompanied by a *session state* that stores the security characteristics of the association.

A TLS session underlies each secure association in Artix.

---

## Colocation

For *colocated invocations*, that is where the calling code and called code share the same address space, Artix supports the establishment of colocated secure associations. A special interceptor, `TLS_CoLoc`, is provided by the security plug-in to optimize the transmission of secure, colocated invocations.

---

## Configuration overview

The security characteristics of an association can be configured through the following CORBA policy types:

- *Client secure invocation policy*—enables you to specify the security requirements on the client side by setting association options. See [“Choosing Client Behavior” on page 287](#) for details.
- *Target secure invocation policy*—enables you to specify the security requirements on the server side by setting association options. See [“Choosing Target Behavior” on page 289](#) for details.
- *Mechanism policy*—enables you to specify the security mechanism used by secure associations. In the case of TLS, you are required to specify a list of cipher suites for your application. See [“Specifying Cipher Suites” on page 295](#) for details.

Figure 36 illustrates all of the elements that configure a secure association. The security characteristics of the client and the server can be configured independently of each other.

**Figure 36:** Configuration of a Secure Association

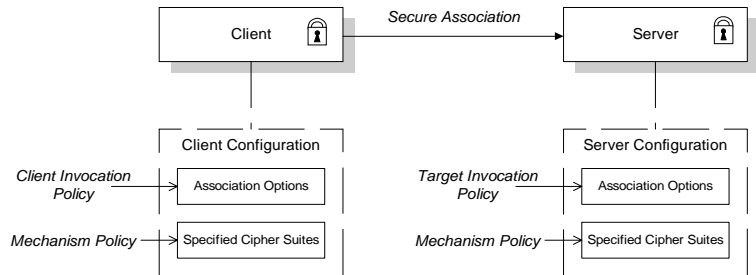

---

# Setting Association Options

---

**Overview**

This section explains the meaning of the various association options and describes how you can use the association options to set client and server secure invocation policies for HTTPS and IIOP/TLS connections.

---

**In this section**

The following subsections discuss the meaning of the settings and flags:

<a href="#">Secure Invocation Policies</a>	<a href="#">page 283</a>
<a href="#">Association Options</a>	<a href="#">page 285</a>
<a href="#">Choosing Client Behavior</a>	<a href="#">page 287</a>
<a href="#">Choosing Target Behavior</a>	<a href="#">page 289</a>
<a href="#">Hints for Setting Association Options</a>	<a href="#">page 291</a>



---

## Secure Invocation Policies

---

### Secure invocation policies

You can set the minimum security requirements for the applications in your system with two types of security policy:

- *Client secure invocation policy*—specifies the client association options.
- *Target secure invocation policy*—specifies the association options on a target object.

These policies can only be set through configuration; they cannot be specified programmatically by security-aware applications.

---

### IIOP/TLS configuration example

For example, to specify that client authentication is required for IIOP/TLS connections, you can set the following target secure invocation policy for your server:

```
# Artix Configuration File
secure_server_enforce_client_auth
{
  # IIOP/TLS Association Options
  policies:iiop_tls:target_secure_invocation_policy:requires =
  ["EstablishTrustInClient", "Confidentiality", "Integrity",
  "DetectReplay", "DetectMisordering"];

  policies:iiop_tls:target_secure_invocation_policy:supports =
  ["EstablishTrustInClient", "Confidentiality", "Integrity",
  "DetectReplay", "DetectMisordering",
  "EstablishTrustInTarget"];

  # Other settings (not shown)...
};
```

**HTTPS configuration example**

For example, to specify that client authentication is required for HTTPS connections, you can set the following target secure invocation policy for your server:

```
# Artix Configuration File
secure_server_enforce_client_auth
{
  # HTTPS Association Options
  policies:target_secure_invocation_policy:requires =
  ["EstablishTrustInClient", "Confidentiality", "Integrity",
  "DetectReplay", "DetectMisordering"];

  policies:target_secure_invocation_policy:supports =
  ["EstablishTrustInClient", "Confidentiality", "Integrity",
  "DetectReplay", "DetectMisordering",
  "EstablishTrustInTarget"];

  # Other settings (not shown)...
};
```

---

## Association Options

---

### Available options

You can use *association options* to configure IIOP/TLS secure associations. They can be set for clients or servers where appropriate. These are the available options:

- `NoProtection`
- `Integrity`
- `Confidentiality`
- `DetectReplay`
- `DetectMisordering`
- `EstablishTrustInTarget`
- `EstablishTrustInClient`

---

### NoProtection

Use the `NoProtection` flag to set minimal protection. This means that insecure bindings are supported, and (if the application supports something other than `NoProtection`) the target can accept secure and insecure invocations.

---

### Integrity

Use the `Integrity` flag to indicate that your application supports integrity-protected invocations. Setting this flag implies that your TLS cipher suites support message digests (such as MD5, SHA1).

---

### Confidentiality

Use the `Confidentiality` flag if your application requires or supports at least confidentiality-protected invocations. The object can support this feature if the cipher suites specified by the `MechanismPolicy` support confidentiality-protected invocations.

---

### DetectReplay

Use the `DetectReplay` flag to indicate that your application supports or requires replay detection on invocation messages. This is determined by characteristics of the supported TLS cipher suites.

---

### DetectMisordering

Use the `DetectMisordering` flag to indicate that your application supports or requires error detection on fragments of invocation messages. This is determined by characteristics of the supported TLS cipher suites.

---

**EstablishTrustInTarget**

The `EstablishTrustInTarget` flag is set for client policies only. Use the flag to indicate that your client supports or requires that the target authenticate its identity to the client. This is determined by characteristics of the supported TLS cipher suites. This is normally set for both client `supports` and `requires` unless anonymous cipher suites are supported.

---

**EstablishTrustInClient**

Use the `EstablishTrustInClient` flag to indicate that your target object requires the client to authenticate its privileges to the target. This option cannot be required as a client policy.

If this option is supported on a client's policy, it means that the client is prepared to authenticate its privileges to the target. On a target policy, the target supports having the client authenticate its privileges to the target.

---

## Choosing Client Behavior

---

### Client secure invocation policy

The client secure invocation policy type determines how a client handles security issues.

---

### IIOPTLS configuration

You can set this policy for IIOPTLS connections through the following configuration variables:

```
policies:iioptls:client_secure_invocation_policy:requires
```

Specifies the minimum security features that the client requires to establish an IIOPTLS connection.

```
policies:iioptls:client_secure_invocation_policy:supports
```

Specifies the security features that the client is able to support on IIOPTLS connections.

---

### HTTPS configuration

You can set this policy for HTTPS connections through the following generic configuration variables:

```
policies:client_secure_invocation_policy:requires
```

Specifies the minimum security features that the client requires to establish a HTTPS connection or an IIOPTLS connection.

```
policies:client_secure_invocation_policy:supports
```

Specifies the security features that the client is able to support on HTTPS connections and IIOPTLS connections.

---

### Association options

In both cases, you provide the details of the security levels in the form of `AssociationOption` flags—see [“Association Options” on page 285](#).

---

### Default value

The default value for the client secure invocation policy is:

```
supports Integrity, Confidentiality, DetectReplay,
DetectMisordering, EstablishTrustInTarget
```

```
requires Integrity, Confidentiality, DetectReplay,
DetectMisordering, EstablishTrustInTarget
```

**Example**

The following example shows some sample settings for the client secure invocation policy:

```
# Artix Configuration File
bank_client {
  ...
  policies:iiop_tls:client_secure_invocation_policy:requires =
    ["Confidentiality", "Integrity", "DetectReplay",
    "DetectMisordering", "EstablishTrustInTarget"];

  policies:iiop_tls:client_secure_invocation_policy:supports =
    ["Confidentiality", "Integrity", "DetectReplay",
    "DetectMisordering", "EstablishTrustInTarget"];
};
...
};
```

---

## Choosing Target Behavior

---

### Target secure invocation policy

The target secure invocation policy type operates in a similar way to the client secure invocation policy type. It determines how a target handles security issues.

---

### IIOPTLS configuration

You can set the target secure invocation policy for IIOPTLS connections through the following configuration variables:

`policies:iioptls:target_secure_invocation_policy:requires`  
 Specifies the minimum security features that your targets require, before they accept an IIOPTLS connection.

`policies:iioptls:target_secure_invocation_policy:supports`  
 Specifies the security features that your targets are able to support on IIOPTLS connections.

---

### HTTPS configuration

You can set the target secure invocation policy for HTTPS connections through the following configuration variables:

`policies:target_secure_invocation_policy:requires`  
 Specifies the minimum security features that your targets require, before they accept a HTTPS connection.

`policies:target_secure_invocation_policy:supports`  
 Specifies the security features that your targets are able to support on HTTPS connections.

---

### Association options

In both cases, you can provide the details of the security levels in the form of `AssociationOption` flags—see [“Association Options” on page 285](#).

---

### Default value for IIOPTLS

The default value for the IIOPTLS target secure invocation policy is:

<code>supports</code>	Integrity, Confidentiality, DetectReplay, DetectMisordering, EstablishTrustInTarget
<code>requires</code>	Integrity, Confidentiality, DetectReplay, DetectMisordering

---

**Default value for HTTPS**

The default value for the HTTPS target secure invocation policy is:

```
supports      Integrity, Confidentiality, DetectReplay,
              DetectMisordering, EstablishTrustInTarget,
              EstablishTrustInClient
requires      Integrity, Confidentiality, DetectReplay,
              DetectMisordering, EstablishTrustInClient
```

In contrast to the IIOP/TLS policy, the HTTPS policy additionally requires `EstablishTrustInClient` by default.

---

**Example**

The following example shows some sample settings for the target secure invocation policy:

```
# Artix Configuration File
...
bank_server {
  ...
  policies:iiop_tls:target_secure_invocation_policy:requires =
    ["Confidentiality", "Integrity", "DetectReplay",
    "DetectMisordering"];

  policies:iiop_tls:target_secure_invocation_policy:supports =
    ["Confidentiality", "Integrity", "DetectReplay",
    "DetectMisordering", "EstablishTrustInTarget"];
  ...
};
...
```



---

## Hints for Setting Association Options

---

### Overview

This section gives an overview of how association options can be used in real applications.

---

### Rules of thumb

The following rules of thumb should be kept in mind:

- If an association option is *required* by a particular invocation policy, it must also be *supported* by that invocation policy. It makes no sense to require an association option without supporting it.
  - It is important to be aware that the secure invocation policies and the security mechanism policy mutually interact with each other. That is, the association options effective for a particular secure association depend on the available cipher suites (see [“Constraints Imposed on Cipher Suites” on page 302](#)).
  - The `NoProtection` option must appear alone in a list of *required* options. It does not make sense to require other security options in addition to `NoProtection`.
- 

### Types of association option

Association options can be categorized into the following different types, as shown in [Table 4](#).

**Table 4:** *Description of Different Types of Association Option*

Description	Relevant Association Options
Request or require TLS peer authentication.	<a href="#">EstablishTrustInTarget</a> and <a href="#">EstablishTrustInClient</a> .
Quality of protection.	<a href="#">Confidentiality</a> , <a href="#">Integrity</a> , <a href="#">DetectReplay</a> , and <a href="#">DetectMisordering</a> .
Allow or require insecure connections.	<a href="#">NoProtection</a> .

## EstablishTrustInTarget and EstablishTrustInClient

These association options are used as follows:

- `EstablishTrustInTarget`—determines whether a server sends its own X.509 certificate to a client during the SSL/TLS handshake. In practice, secure Artix applications must enable `EstablishTrustInTarget`, because all of the cipher suites supported by Artix require it.

The `EstablishTrustInTarget` association option should appear in all of the configuration variables shown in the relevant row of [Table 5](#).

- `EstablishTrustInClient`—determines whether a client sends its own X.509 certificate to a server during the SSL/TLS handshake. The `EstablishTrustInClient` feature is optional and various combinations of settings are possible involving this association option.

The `EstablishTrustInClient` association option can appear in any of the configuration variables shown in the relevant row of [Table 5](#).

**Table 5:** *Setting EstablishTrustInTarget and EstablishTrustInClient Association Options*

Association Option	Client side—can appear in...	Server side—can appear in...
<code>EstablishTrustInTarget</code>	<p><code>policies:client_secure_invocation_policy:supports</code></p> <p><code>policies:client_secure_invocation_policy:requires</code></p>	<p><code>policies:target_secure_invocation_policy:supports</code></p>
<code>EstablishTrustInClient</code>	<p><code>policies:client_secure_invocation_policy:supports</code></p>	<p><code>policies:target_secure_invocation_policy:supports</code></p> <p><code>policies:target_secure_invocation_policy:requires</code></p>

**Note:** The SSL/TLS client authentication step can also be affected by the `policies:allow_unauthenticated_clients_policy` configuration variable. See “[policies](#)” on page 445.

**Confidentiality, Integrity, DetectReplay, and DetectMisordering**

These association options can be considered together, because normally you would require either all or none of these options. Most of the cipher suites supported by Orbix support all of these association options, although there are a couple of integrity-only ciphers that do not support `Confidentiality` (see [Table 9 on page 303](#)). As a rule of thumb, if you want security you generally would want *all* of these association options.

**Table 6:** *Setting Quality of Protection Association Options*

Association Options	Client side—can appear in...	Server side—can appear in...
Confidentiality, Integrity, DetectReplay, and DetectMisordering	<p>policies:client_secure_invocation_policy:supports</p> <p>policies:client_secure_invocation_policy:requires</p>	<p>policies:target_secure_invocation_policy:supports</p> <p>policies:target_secure_invocation_policy:requires</p>

A typical secure application would list *all* of these association options in *all* of the configuration variables shown in [Table 6](#).

**Note:** Some of the sample configurations appearing in the generated configuration file require `Confidentiality`, but not the other qualities of protection. In practice, however, the list of required association options is implicitly extended to include the other qualities of protection, because the cipher suites that support `Confidentiality` also support the other qualities of protection. This is an example of where the security mechanism policy interacts with the secure invocation policies.

**NoProtection**

The `NoProtection` association option is used for two distinct purposes:

- *Disabling security selectively*—security is disabled, either in the client role or in the server role, if `NoProtection` appears as the sole *required* association option and as the sole *supported* association option in a secure invocation policy. This mechanism is selective in the sense that the client role and the server role can be independently configured as either secure or insecure.

**Note:** In this case, the `orb_plugins` configuration variable should include the `iiop` plug-in to enable insecure IIOp communication.

- *Making an application semi-secure*—an application is semi-secure, either in the client role or in the server role, if `NoProtection` appears as the sole *required* association option and as a *supported* association option along with other secure association options. The meaning of semi-secure in this context is, as follows:
  - ◆ *Semi-secure client*—the client will open either a secure or an insecure connection, depending on the disposition of the server (that is, depending on whether the server accepts only secure connections or only insecure connections). If the server is semi-secure, the type of connection opened depends on the order of the bindings in the `binding:client_binding_list`.
  - ◆ *Semi-secure server*—the server accepts connections either from a secure or an insecure client.

**Note:** In this case, the `orb_plugins` configuration variable should include both the `iiop_tls` plug-in and the `iiop` plug-in.

Table 7 shows the configuration variables in which the `NoProtection` association option can appear.

**Table 7:** *Setting the NoProtection Association Option*

Association Option	Client side—can appear in...	Server side—can appear in...
NoProtection	<p><code>policies:client_secure_invocation_policy:supports</code></p> <p><code>policies:client_secure_invocation_policy:requires</code></p>	<p><code>policies:target_secure_invocation_policy:supports</code></p> <p><code>policies:target_secure_invocation_policy:requires</code></p>

---

# Specifying Cipher Suites

## Overview

---

This section explains how to specify the list of cipher suites that are made available to an application (client or server) for the purpose of establishing IOP/TLS and HTTPS secure associations. During a security handshake, the client chooses a cipher suite that matches one of the cipher suites available to the server. The cipher suite then determines the security algorithms that are used for the secure association.

---

## In this section

This section contains the following subsections:

<a href="#">Supported Cipher Suites</a>	<a href="#">page 296</a>
<a href="#">Setting the Mechanism Policy</a>	<a href="#">page 299</a>
<a href="#">Constraints Imposed on Cipher Suites</a>	<a href="#">page 302</a>

---

## Supported Cipher Suites

---

### Artix cipher suites

The following cipher suites are supported by IIOp/TLS and HTTPS, which are both implemented using the Baltimore security toolkit:

- Null encryption, integrity-only ciphers:

```
RSA_WITH_NULL_MD5
RSA_WITH_NULL_SHA
```

- Standard ciphers

```
RSA_EXPORT_WITH_RC4_40_MD5
RSA_WITH_RC4_128_MD5
RSA_WITH_RC4_128_SHA
RSA_EXPORT_WITH_DES40_CBC_SHA
RSA_WITH_DES_CBC_SHA
RSA_WITH_3DES_EDE_CBC_SHA
```

---

### Security algorithms

Each cipher suite specifies a set of three security algorithms, which are used at various stages during the lifetime of a secure association:

- *Key exchange algorithm*—used during the security handshake to enable authentication and the exchange of a symmetric key for subsequent communication. Must be a public key algorithm.
  - *Encryption algorithm*—used for the encryption of messages after the secure association has been established. Must be a symmetric (private key) encryption algorithm.
  - *Secure hash algorithm*—used for generating digital signatures. This algorithm is needed to guarantee message integrity.
- 

### Key exchange algorithms

The following key exchange algorithms are supported:

RSA	Rivest Shamir Adleman (RSA) public key encryption using X.509v3 certificates. No restriction on the key size.
RSA_EXPORT	RSA public key encryption using X.509v3 certificates. Key size restricted to 512 bits.

**Encryption algorithms**

---

The following encryption algorithms are supported:

RC4_40	A symmetric encryption algorithm developed by RSA data security. Key size restricted to 40 bits.
RC4_128	RC4 with a 128-bit key.
DES40_CBC	Data encryption standard (DES) symmetric encryption. Key size restricted to 40 bits.
DES_CBC	DES with a 56-bit key.
3DES_EDE_CBC	Triple DES (encrypt, decrypt, encrypt) with an effective key size of 168 bits.

---

**Secure hash algorithms**

The following secure hash algorithms are supported:

MD5	Message Digest 5 (MD5) hash algorithm. This algorithm produces a 128-bit digest.
SHA	Secure hash algorithm (SHA). This algorithm produces a 160-bit digest, but is somewhat slower than MD5.

---

**Cipher suite definitions**

The Baltimore-based cipher suites in Artix are defined as follows:

**Table 8:** *Cipher Suite Definitions*

Cipher Suite	Key Exchange Algorithm	Encryption Algorithm	Secure Hash Algorithm	Exportable?
RSA_WITH_NULL_MD5	RSA	NULL	MD5	<i>yes</i>
RSA_WITH_NULL_SHA	RSA	NULL	SHA	<i>yes</i>
RSA_EXPORT_WITH_RC4_40_MD5	RSA_EXPORT	RC4_40	MD5	<i>yes</i>
RSA_WITH_RC4_128_MD5	RSA	RC4_128	MD5	<i>no</i>
RSA_WITH_RC4_128_SHA	RSA	RC4_128	SHA	<i>no</i>
RSA_EXPORT_WITH_DES40_CBC_SHA	RSA_EXPORT	DES40_CBC	SHA	<i>yes</i>
RSA_WITH_DES_CBC_SHA	RSA	DES_CBC	SHA	<i>no</i>
RSA_WITH_3DES_EDE_CBC_SHA	RSA	3DES_EDE_CBC	SHA	<i>no</i>

---

**Reference**

For further details about cipher suites in the context of TLS, see RFC 2246 from the Internet Engineering Task Force (IETF). This document is available from the IETF Web site: <http://www.ietf.org>.



---

## Setting the Mechanism Policy

---

### Mechanism policy

To specify IIOP/TLS cipher suites, use the *mechanism policy*. The mechanism policy is a client and server side security policy that determines

- Whether SSL or TLS is used, and
- Which specific cipher suites are to be used.

### The `protocol_version` configuration variable

You can specify whether SSL, TLS or both are used with a transport protocol by assigning a list of protocol versions to the

`policies:iiop_tls:mechanism_policy:protocol_version` configuration variable for IIOP/TLS and the

`policies:https:mechanism_policy:protocol_version` configuration variable for HTTPS. For example:

```
# Artix Configuration File
policies:iiop_tls:mechanism_policy:protocol_version = ["TLS_V1",
"SSL_V3"];
```

You can set the `protocol_version` configuration variable to include one or more of the following protocols:

```
TLS_V1
SSL_V3
```

The order of the entries in the `protocol_version` list is unimportant. During the SSL/TLS handshake, the highest common protocol will be negotiated.

### Interoperating with CORBA applications on OS/390

There are some implementations of SSL/TLS on the OS/390 platform that erroneously send SSL V2 client hellos at the start of an SSL V3 or TLS V1 handshake. If you need to interoperate with a CORBA application running on OS/390, you can configure Artix to accept SSL V2 client hellos using the `policies:iiop_tls:mechanism_policy:accept_v2_hellos` configuration variable for IIOP/TLS. For example:

```
# Artix Configuration File
policies:iiop_tls:mechanism_policy:accept_v2_hellos = "true";
```

The default is `false`.

**The cipher suites configuration variable**

You can specify the cipher suites available to a transport protocol by setting the `policies:iioptls:mechanism_policy:ciphersuites` configuration variable for IIOp/TLS and the `policies:https:mechanism_policy:ciphersuites` configuration variable for HTTPS. For example:

```
# Artix Configuration File
policies:iioptls:mechanism_policy:ciphersuites =
["RSA_WITH_NULL_MD5",
 "RSA_WITH_NULL_SHA",
 "RSA_EXPORT_WITH_RC4_40_MD5",
 "RSA_WITH_RC4_128_MD5" ];
```

**Cipher suite order**

The order of the entries in the mechanism policy's cipher suites list is important.

During a security handshake, the client sends a list of acceptable cipher suites to the server. The server then chooses the first of these cipher suites that it finds acceptable. The secure association is, therefore, more likely to use those cipher suites that are near the beginning of the `ciphersuites` list.

**Valid cipher suites**

You can specify any of the following cipher suites:

- Null encryption, integrity only ciphers:

```
RSA_WITH_NULL_MD5,
RSA_WITH_NULL_SHA
```

- Standard ciphers

```
RSA_EXPORT_WITH_RC4_40_MD5,
RSA_WITH_RC4_128_MD5,
RSA_WITH_RC4_128_SHA,
RSA_EXPORT_WITH_DES40_CBC_SHA,
RSA_WITH_DES_CBC_SHA,
RSA_WITH_3DES_EDE_CBC_SHA
```

**Default values**

If no cipher suites are specified through configuration or application code, the following apply:

```
RSA_WITH_RC4_128_SHA,
RSA_WITH_RC4_128_MD5,
RSA_WITH_3DES_EDE_CBC_SHA,
RSA_WITH_DES_CBC_SHA
```

That is, by default all of the null encryption cipher suites are disabled and all of the non-export cipher suites are supported.

## Constraints Imposed on Cipher Suites

### Effective cipher suites

Figure 37 shows that cipher suites initially specified in the configuration are *not* necessarily made available to the application. Artix checks each cipher suite for compatibility with the specified association options and, if necessary, reduces the size of the list to produce a list of *effective cipher suites*.

**Figure 37:** *Constraining the List of Cipher Suites*

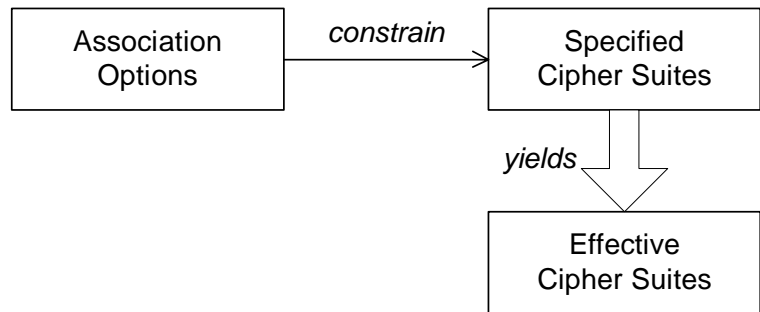

### Required and supported association options

For example, in the context of the IIOP/TLS protocol the list of cipher suites is affected by the following configuration options:

- *Required association options*—as listed in `policies:iiop_tls:client_secure_invocation_policy:requires` ON the client side, or `policies:iiop_tls:target_secure_invocation_policy:requires` ON the server side.
- *Supported association options*—as listed in `policies:iiop_tls:client_secure_invocation_policy:supports` ON the client side, or `policies:iiop_tls:target_secure_invocation_policy:supports` ON the server side.

**Cipher suite compatibility table**

Use [Table 9](#) to determine whether or not a particular cipher suite is compatible with your association options.

**Table 9:** *Association Options Supported by Cipher Suites*

Cipher Suite	Supported Association Options
RSA_WITH_NULL_MD5	Integrity, DetectReplay, DetectMisordering
RSA_WITH_NULL_SHA	Integrity, DetectReplay, DetectMisordering
RSA_EXPORT_WITH_RC4_40_MD5	Integrity, DetectReplay, DetectMisordering, Confidentiality
RSA_WITH_RC4_128_MD5	Integrity, DetectReplay, DetectMisordering, Confidentiality
RSA_WITH_RC4_128_SHA	Integrity, DetectReplay, DetectMisordering, Confidentiality
RSA_EXPORT_WITH_DES40_CBC_SHA	Integrity, DetectReplay, DetectMisordering, Confidentiality
RSA_WITH_DES_CBC_SHA	Integrity, DetectReplay, DetectMisordering, Confidentiality
RSA_WITH_3DES_EDE_CBC_SHA	Integrity, DetectReplay, DetectMisordering, Confidentiality

**Determining compatibility**

The following algorithm is applied to the initial list of cipher suites:

1. For the purposes of the algorithm, ignore the `EstablishTrustInClient` and `EstablishTrustInTarget` association options. These options have no effect on the list of cipher suites.
2. From the initial list, remove any cipher suite whose supported association options (see [Table 9](#)) do not satisfy the configured required association options.
3. From the remaining list, remove any cipher suite that supports an option (see [Table 9](#)) not included in the configured supported association options.

---

**No suitable cipher suites available** If no suitable cipher suites are available as a result of incorrect configuration, no communications will be possible and an exception will be raised. Logging also provides more details on what went wrong.

---

**Example** For example, specifying a cipher suite such as `RSA_WITH_RC4_128_MD5` that supports `Confidentiality`, `Integrity`, `DetectReplay`, `DetectMisordering`, `EstablishTrustInTarget` (and optionally `EstablishTrustInClient`) but specifying a `secure_invocation_policy` that supports only a subset of those features results in that cipher suite being ignored.

---

# Caching Sessions

---

## Session caching policy

You can use the IIOPTLS and HTTPS session caching policies to control TLS session caching and reuse for both the client side and the server side.

---

## Configuration variable

You can set the session caching policy with the `policies:iioptls:session_caching_policy` or `policies:session_caching_policy` configuration variables. For example:

```
policies:iioptls:session_caching_policy = "CACHE_CLIENT";
```

---

## Valid values

You can apply the following values to the session caching policy:

```
CACHE_NONE,  
CACHE_CLIENT,  
CACHE_SERVER,  
CACHE_SERVER_AND_CLIENT
```

---

## Default value

The default value is `CACHE_NONE`.

---

## Configuration variable

```
plugins:atli_tls_tcp:session_cache_validity_period
```

This allows control over the period of time that SSL/TLS session caches are valid for.

---

## Valid values

`session_cache_validity_period` is specified in seconds.

---

## Default value

The default value is 1 day.

---

## Configuration variable

```
plugins:atli_tls_tcp:session_cache_size
```

`session_cache_size` is the maximum number of SSL/TLS sessions that are cached before sessions are flushed from the cache.

---

## Default value

This defaults to no limit specified for C++.





# Principal Propagation

*Principal propagation is a compatibility feature of Artix that is designed to facilitate interoperability with legacy Orbix applications.*

---

**In this chapter**

This chapter discusses the following topics:

<a href="#">Introduction to Principal Propagation</a>	<a href="#">page 308</a>
<a href="#">Configuring</a>	<a href="#">page 309</a>
<a href="#">Programming</a>	<a href="#">page 312</a>
<a href="#">Interoperating with .NET</a>	<a href="#">page 315</a>

---

# Introduction to Principal Propagation

---

## Overview

Artix principal propagation is a transport-neutral mechanism that can be used to transmit a secure identity from a client to a server. It is *not* recommended that you use this feature in new applications. Principal propagation is provided primarily in order to facilitate interoperability with legacy Orbix applications.

**WARNING:** By default, the principal is propagated across the wire in plaintext. Hence, the principal is vulnerable to snooping. To protect against this possibility, you should enable SSL for your application.

---

## Supported bindings/transports

Support for principal propagation is limited to the following bindings and transports:

- CORBA binding—the principal is sent in a GIOP service context.
- SOAP over HTTP—the principal is sent in a SOAP header.

**Note:** If a CORBA call is colocated, the principal is not propagated unless you remove the `POA_Coloc` interceptor from the binding lists in the `artix.cfg` file. This has the effect of disabling the CORBA colocated binding optimization.

---

## Interoperability

The primary purpose of Artix principal propagation is to facilitate interoperability with legacy Orbix applications, in particular for applications running on the mainframe.

Because Artix uses standard mechanisms to propagate the principal, this feature ought to be compatible with third-party products as well.

---

# Configuring

## Overview

This section describes how to configure Artix to use principal propagation. The following aspects of configuration are described:

- [CORBA](#).
- [SOAP over HTTP](#).
- [Routing](#).

**Note:** Principal configuration is not supported for any other bindings, apart from CORBA and SOAP over HTTP.

---

## CORBA

To use principal propagation with a CORBA binding, you must set the following configuration variables in your `artix.cfg` file (located in the `ArtixInstallDir/artix/Version/etc/domains` directory):

### Example 52: Configuring Principal Propagation for a CORBA Binding

```
policies:giop:interop_policy:send_principal = "true";
policies:giop:interop_policy:enable_principal_service_context =
    "true";
```

You can either add these settings to the global scope or to a specific sub-scope (in which case you must specify the sub-scope to the `-ORBname` command line switch when running the Artix application).

---

## SOAP over HTTP

SOAP over HTTP requires no special configuration to support principal propagation. The Artix SOAP binding will always add a principal header. The following cases arise:

- *Principal set explicitly*—the specified principal is sent in the principal header.
- *Principal not set*—Artix reads the username from the operating system and sends this username in the principal header.

If you want a SOAP server to authenticate a propagated principal using the Artix security service, however, you do need to add some settings to the server's configuration scope in your `artix.cfg` file, as shown in [Example 53](#).

**Example 53:** *Configuring Principal Authentication for SOAP*

```
# Security Layer Settings
policies:asp:enable_authorization = "true";
plugins:is2_authorization:action_role_mapping =
    "file://C:\artix\artix\1.2\demos\secure_hello_world\http_soap
    /config/helloworld_action_role_mapping.xml";
plugins:asp:authorization_realm = "IONAGlobalRealm";

plugins:asp:security_level = "REQUEST_LEVEL";
plugins:asp:default_password = "default_password";
```

Setting `plugins:asp:security_level` equal to `REQUEST_LEVEL` specifies that the received principal serves as the username for the purpose of authentication. The `plugins:asp:default_password` value serves as the password for the purpose of authentication. This latter setting is necessary because, although the Artix security service requires a password, there is no password propagated with the principal.

**WARNING:** The procedure of supplying a default password for the principal enables you to integrate principals with the Artix security service. Users identified in this way, however, do *not* have the same status as properly authenticated users. For security purposes, such users should enjoy lesser privileges and be treated in the same way as unauthenticated users.

The net effect of the configuration shown in [Example 53](#) is that the SOAP server performs authentication by contacting the central Artix security service.

See also [“Security Layer” on page 18](#) and [“Configuring the Artix Security Service” on page 145](#) for more details about configuring the Artix security service.

**Routing**

---

The Artix router automatically propagates the Principal from the route source to the route destination, as long as the bindings in the route are either CORBA or SOAP/HTTP.

---

# Programming

---

## Overview

This section describes how to program an Artix client and server to set (client side) and get (server side) a principal value.

The code examples are written using the contexts API. For more details about contexts, see *Developing Artix Applications in C++*.

---

## Client example

**Example 54** shows how to set the principal prior to invoking an operation, `echoString()`, on a proxy object, of `MyProxy` type.

### Example 54: Setting a Principal on the Client Side

```
// C++

#include <it_bus/bus.h>
#include <it_bus/exception.h>
#include <it_cal/iostream.h>

// Include header files related to the bus-security context
#include <it_bus_pdk/context.h>
#include <it_bus_pdk/context_attrs/context_constants.h>

IT_USING_NAMESPACE_STD

using namespace IT_ContextAttributes;
using namespace IT_Bus;

int
main(int argc, char* argv[])
{
    try
    {
        IT_Bus::Bus_var bus = IT_Bus::init(argc, argv);

        ContextRegistry* context_registry =
            bus->get_context_registry();

        // Obtain a reference to the ContextCurrent
        ContextCurrent& context_current =
            context_registry->get_current();
    }
}
```

**Example 54: Setting a Principal on the Client Side**

```

1 // Obtain a pointer to the Request ContextContainer
ContextContainer* context_container =
    context_current.request_contexts();

// Set the principal context value
IT_Bus::String principal("artix_user");
context_container->set_context_as_string(
    PRINCIPAL_CONTEXT_ATTRIBUTE,
    principal
);
...
// Invoke the remote operation, echoString()
MyProxy echo_proxy;
echo_proxy.echoString("Echo me!")
}
catch(IT_Bus::Exception& e)
{
    cout << endl << "Error : Unexpected error occurred!"
        << endl << e.message()
        << endl;
    return -1;
}
return 0;
}

```

The preceding code can be explained as follows:

1. Call `IT_Bus::ContextContainer::set_context_as_string()` to initialize the string value of the principal context. The `IT_ContextAttributes::PRINCIPAL_CONTEXT_ATTRIBUTE` constant is a `QName` constant, initialized with the context name of the pre-registered principal context.

**Server example**

**Example 55** shows how to read the principal on the server side, when the servant is invoked by a client that uses principal propagation.

**Example 55: Reading the Principal on the Server Side**

```

// C++
// in operation
void MyImpl::echoString(const IT_Bus::String& inputString,
                       IT_Bus::String& Response)
IT_THROW_DECL((IT_Bus::Exception))
{
    Response = inputString;
    try {
        IT_Bus::Bus_var bus = IT_Bus::Bus::create_reference();

        ContextRegistry* context_registry =
            bus->get_context_registry();

        // Obtain a reference to the ContextCurrent
        ContextCurrent& context_current =
            context_registry->get_current();

        // Obtain a pointer to the Request ContextContainer
        ContextContainer* context_container =
            context_current.request_contexts();

        // Obtain a reference to the context
        IT_Bus::String & principal =
            context_container->get_context_as_string(
                PRINCIPAL_CONTEXT_ATTRIBUTE,
                );
        ...
    }
    catch(IT_Bus::Exception& e) { ... }
}

```

The preceding server example can be explained as follows:

1. The `IT_Bus::ContextContainer::get_context_as_string()` function returns the principal value that was extracted from the received request message.



---

# Interoperating with .NET

## Overview

---

If your Artix applications must interoperate with other Web service products, for example .NET, you need to modify your WSDL contract in order to make the principal header interoperable. This section describes the changes you can make to a WSDL contract to facilitate interoperability with other Web services platforms.

---

## In this section

This section contains the following subsections:

<a href="#">Explicitly Declaring the Principal Header</a>	<a href="#">page 316</a>
<a href="#">Modifying the SOAP Header</a>	<a href="#">page 318</a>

## Explicitly Declaring the Principal Header

### Overview

Artix applications do not require any modifications to the WSDL contract in order to use principal headers. An Artix service is inherently able to read a user's principal from a received SOAP header.

In contrast to this, non-Artix services, for example, .NET services, require the principal header to be declared *explicitly* in the WSDL contract. Otherwise, the non-Artix services would be unable to access the principal.

### Declaring the principal header in WSDL

[Example 56](#) shows the typical modifications you must make to a WSDL contract in order to make the principal value accessible to non-Artix applications.

#### Example 56: WSDL Declaration of the Principal Header

```

<definitions ... >
  <types>
    <schema targetNamespace="TypeSchema" ... >
      ...
      1     <element name="principal" type="xsd:string"/>
      ...
    </schema>
  </type>
  ...
  2 <message targetNamespace="http://schemas.iona.com/security"
    name="principal">
  3   <part element="TypePrefix:principal" name="principal"/>
  </message>
  ...
  4 <binding ... xmlns:sec="http://schemas.iona.com/security">
    ...
  5   <operation ...>
    ...
    <input>
      <soap:body ...>
      6     <soap:header message="sec:principal"
        part="principal" use="literal">
    </input>
    </operation>
  </binding>
  ...
</definitions>

```

The preceding WSDL extract can be explained as follows:

1. Declare a `principal` element in the type schema, which must be declared to be of type, `xsd:string`. In this example, the `principal` element belongs to the `TypeSchema` namespace.
2. Add a new `message` element.
3. The `<part>` tag's `element` attribute is set equal to the QName of the preceding `principal` element. Hence, in this example the `TypePrefix` appearing in `element="TypePrefix:principal"` must be a prefix associated with the `TypeSchema` namespace.
4. Edit the binding, or bindings, for which you might need to access the principal header. You should define a prefix for the `http://schemas.iona.com/security` namespace within the `<binding>` tag, which in this example is `sec`.
5. Edit each operation for which you might need to access the principal header.
6. Add a `<soap:header>` tag to the operation's input part, as shown.

## Modifying the SOAP Header

### Overview

It is possible to change the default format of the principal header by making appropriate modifications to the WSDL contract. It is usually not necessary to modify the header format in this way, but in some cases it could facilitate interoperability.

### Default SOAP header

By default, when a client uses principal propagation with SOAP over HTTP, the input message sent over the wire includes the following form of header:

```
<SOAP-ENV:Header>
  <sec:principal xmlns:sec="http://schemas.iona.com/security"
    xsi:type="xsd:string">my_principal</sec:principal>
</SOAP-ENV:Header>
```

### Custom SOAP header

You can change the form of the SOAP header that is sent over the wire to have the following custom format (replacing `<sec:principal>` by a custom tag, `<sec:PrincipalTag>`):

```
<SOAP-ENV:Header>
  <sec:PrincipalTag
    xmlns:sec="http://schemas.iona.com/security"
    xsi:type="xsd:string">my_principal</sec:PrincipalTag>
</SOAP-ENV:Header>
```

### WSDL modifications

To change the tag that is sent in the SOAP header to be `PrincipalTag`, you can modify your WSDL contract as shown in [Example 57](#).

#### Example 57: Customizing the Form of the Principal Header

```
<definitions ... >
  <types>
    <schema targetNamespace="TypeSchema" ... >
      ...
      <element name="PrincipalTag" type="xsd:string"/>
      ...
    </schema>
  </type>
  ...
```

**Example 57:** Customizing the Form of the Principal Header

```

2      <message targetNamespace="http://schemas.iona.com/security"
          name="principal">
          <part element="TypePrefix:PrincipalTag"
3      name="principal"/>
        </message>
        ...
        <binding ... xmlns:sec="http://schemas.iona.com/security">
        ...
          <operation ...>
            ...
            <input>
              <soap:body ...>
3          <soap:header message="sec:principal"
              part="principal" use="literal">
            </input>
          </operation>
        </binding>
        ...
      </definitions>

```

The preceding WSDL extract can be explained as follows:

1. Modify the `principal` element in the type schema to give it an arbitrary QName. In this example, the `<PrincipalTag>` element belongs to the `TypeSchema` namespace.
2. The `<part>` tag's `element` attribute is set equal to the QName of the preceding `principal` element. Hence, in this example the `TypePrefix` appearing in `element="TypePrefix:PrincipalTag"` must be a prefix associated with the `TypeSchema` namespace.
3. The `<soap:header>` tag must be defined precisely as shown here. That is, when writing or reading a principal header, Artix looks for the principal part of the message with QName, `principal`, in the namespace, `http://schemas.iona.com/security`.



# Bridging between SOAP and CORBA

*When a secure SOAP application interoperates with a secure CORBA application, it is often necessary to transform credentials between the two applications. For example, you might need to transform WSSE username/password credentials embedded in a SOAP header into CSI username/password credentials embedded in a GIOP header.*

**In this chapter**

---

This chapter discusses the following topics:

<a href="#">SOAP-to-CORBA Scenario</a>	<a href="#">page 322</a>
<a href="#">Single Sign-On SOAP-to-CORBA Scenario</a>	<a href="#">page 338</a>
<a href="#">CORBA-to-SOAP Scenario</a>	<a href="#">page 345</a>

---

# SOAP-to-CORBA Scenario

**Overview**

---

This section describes how to integrate a secure SOAP client with a secure CORBA server, by interposing a suitably configured SOAP-to-CORBA Artix router. The router transforms the SOAP client's WSSE username and password credentials into CSI/GSSUP credentials for the CORBA server.

---

**In this section**

This section contains the following subsections:

<a href="#">Overview of the Secure SOAP-to-CORBA Scenario</a>	<a href="#">page 323</a>
<a href="#">SOAP Client</a>	<a href="#">page 325</a>
<a href="#">SOAP-to-CORBA Router</a>	<a href="#">page 329</a>
<a href="#">CORBA Server</a>	<a href="#">page 335</a>



## Overview of the Secure SOAP-to-CORBA Scenario

### Overview

This subsection describes a secure SOAP-to-CORBA scenario, where the router is configured to integrate SOAP security with CORBA security. The key functionality provided by the router in this scenario is the ability to extract SOAP credentials (provided in the form of a WSSE username and password) and propagate them as CORBA-compatible GSSUP credentials.

### SOAP-to-CORBA scenario

Figure 38 shows the outline of a scenario where WSSE username and password credentials, embedded in a SOAP header, are transformed into GSSUP credentials, embedded in a GIOP service context.

**Figure 38:** *Propagating Credentials Across a SOAP-to-CORBA Router*

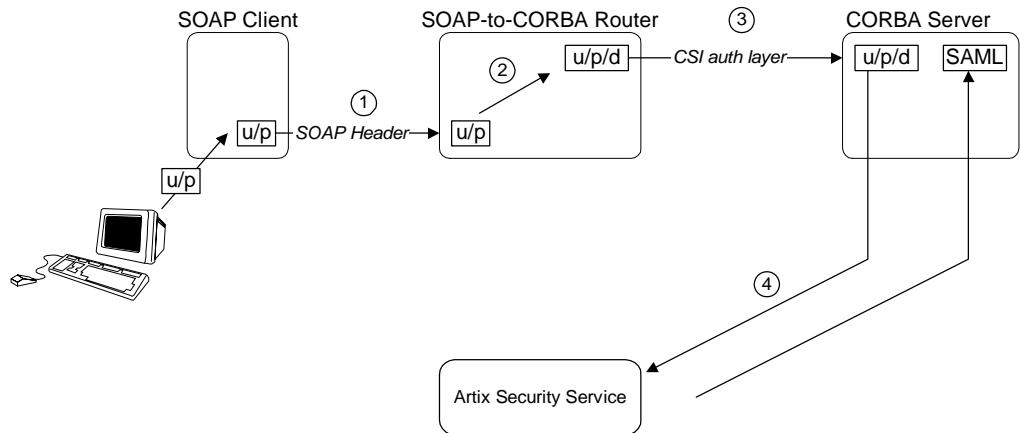

**Steps**

The steps for propagating credentials across the SOAP-to-CORBA router, as shown in [Figure 38](#), can be described as follows:

Stage	Description
1	The client initializes the WSSE username and password credentials, $u/p$ , and sends these credentials, embedded in a WSSE SOAP header, across to the router.
2	The router extracts the received WSSE username and password credentials, $u/p$ , and transfers them into GSSUP credentials, consisting of username, password and domain, $u/p/d$ . The username and password are copied straight into the GSSUP credentials. The domain is set to a blank string (which acts as a wildcard that matches any domain).
3	The GSSUP credentials, $u/p/d$ , are sent on to the CORBA server using the CSI authentication over transport mechanism.
4	The CORBA server authenticates the received GSSUP credentials, $u/p/d$ , by calling out to the Artix security service (this step is performed automatically by the <code>gsp</code> plug-in).

**Demonstration code**

Demonstration code for this SOAP-to-CORBA scenario is available from the following location:

*ArtixInstallDir/artix/Version/demos/security/secure\_soap\_corba*

**Enabling GSSUP propagation**

To enable GSSUP propagation (where received username and password credentials are inserted into the outgoing GSSUP credentials by the router), set the following router configuration variable to `true`:

```
policies:bindings:corba:gssup_propagation = "true";
```

---

# SOAP Client

---

## Overview

When making an invocation, the SOAP client sends username and password credentials in a SOAP header (formatted according to the WSSE standard). This section describes how to program and configure a SOAP client to send WSSE username and password credentials.

---

## Choice of credentials

In this example, the SOAP client is programmed to send username/password credentials in the SOAP header. It is also possible, however, to send username/password credentials in the HTTP header, using the HTTP Basic Authentication mechanism. The propagation mechanism in the router supports either type of credentials.

---

## Setting the WSSE username and password

[Example 58](#) shows how you can program a SOAP client to send username and password credentials using the WSSE standard.

### Example 58: SOAP Client Setting WSSE Username/Password Credentials

```
// C++
...
#include <it_bus_pdk/context.h>
#include <it_bus_pdk/context_attrs/context_constants.h>
#include <it_bus_pdk/context_attrs/bus_security_xsdTypes.h>
...
#include "HelloWorldClient.h"

IT_USING_NAMESPACE_STD

using namespace HW;
using namespace IT_Bus;
using namespace IT_ContextAttributes;

int
main(int argc, char* argv[] )
{
    try
    {
        IT_Bus::init(argc, argv);

        Bus* bus = Bus::create_reference();
        ContextRegistry* registry = bus->get_context_registry();
```

1

**Example 58: SOAP Client Setting WSSE Username/Password Credentials**

```

ContextCurrent& current = registry->get_current();
ContextContainer* request_contexts =
    current.request_contexts();

HelloWorldClient client;
BusSecurity* security_attr;
String* username;
String* token;
String string_out;
2 AnyType* output_attr = request_contexts->get_context(
    SECURITY_SERVER_CONTEXT,
    true
);

3 security_attr = dynamic_cast<BusSecurity*>(output_attr);
4 security_attr->setWSSEUsernameToken("user_test");
5 security_attr->setWSSEPasswordToken("user_password");
client.sayHi(string_out);
...
}
catch(IT_Bus::Exception& e)
{
    ... // Handle exception (not shown)
    return -1;
}
return 0;
}

```

The preceding client code can be explained as follows:

1. The following four lines contain the standard steps for obtaining a pointer to the request context container object, `request_contexts`. The request context container object contains a collection of context objects, which contain various settings that can influence the next invocation request.

For more details about Artix contexts, see the contexts chapter from *Developing Artix Applications in C++*.

2. Obtain a pointer to the `BusSecurity` context object from the request context container. The `BusSecurity` context is selected by passing the `QName` constant, `IT_ContextAttributes::SECURITY_SERVER_CONTEXT`,

as the first parameter to `get_context()`. The second parameter to `get_context()`, with the boolean value `true`, indicates that a new `BusSecurity` instance should be created, if one does not already exist.

3. Cast the return value from `get_context()` to the `IT_ContextAttributes::BusSecurity` type.
4. Call the `setWSSEUsernameToken()` and `setWSSEPasswordToken()` functions to specify the credentials to send with the next invocation. In this example the username and password are sent in the SOAP header and formatted according to the WSSE standard.
5. Invoke the remote WSDL operation, `sayHi`. The specified username and password are propagated in the SOAP header along with this invocation request.

## Client configuration

[Example 59](#) shows the configuration of the SOAP client in this scenario, which uses the `secure_artix.secure_soap_corba.client.gssup` configuration scope.

### Example 59: SOAP Client Configuration

```
# Artix Configuration File
...
secure_artix
{
  secure_soap_corba
  {
    initial_references:IT_SecurityService:reference =
"corbaloc:it_iops:1.2@localhost:58482/IT_SecurityService";

    client
    {
      # Secure HTTPS client-side configuration
      policies:https:trusted_ca_list_policy =
"C:\artix_30\artix\3.0\demos\security\certificates\tls\x509\t
1   rusted_ca_lists/ca_list1.pem";
      policies:client_secure_invocation_policy:requires =
2   ["Confidentiality", "Integrity", "DetectReplay",
"DetectMisordering", "EstablishTrustInTarget"];
      policies:client_secure_invocation_policy:supports =
["Confidentiality", "Integrity", "DetectReplay",
"DetectMisordering", "EstablishTrustInClient",
"EstablishTrustInTarget"];
```

**Example 59: SOAP Client Configuration**

```

3     principal_sponsor:use_principal_sponsor = "true";
      principal_sponsor:auth_method_id = "pkcs12_file";
      principal_sponsor:auth_method_data =
        ["filename=C:\artix_30\artix\3.0\demos\security\certificates\
         openssl\x509\certs\testaspen.p12", "password=testaspen"];
        ...
4     gssup
      {
        orb_plugins = ["xmlfile_log_stream", "https"];
      };
    };
};

```

The preceding client configuration can be explained as follows:

1. The trusted CA list policy specifies a listed of trusted CA certificates. During the SSL handshake, the client checks that the server's certificate is signed by one of the CA certificates from this list.
2. The client's HTTPS security policies require that connections are secure and the server identifies itself by sending an X.509 certificate.
3. Because this client supports mutual SSL authentication, the principal sponsor settings are used to associate an X.509 certificate with the client application.
4. There is no need to list all of the requisite plug-ins explicitly in the `orb_plugins` list. In particular, Artix loads the `at_http` plug-in and the `https` plug-in implicitly, because the client connects to a remote WSDL service that requires HTTPS (the SOAP address that appears in the WSDL contract starts with the `https://` prefix).

---

# SOAP-to-CORBA Router

---

## Overview

The SOAP-to-CORBA router receives incoming SOAP/HTTP requests, translates them into IOP requests and then forwards them on to a CORBA server. In addition to translating requests, the router is also configured to transfer the incoming username/password credentials (embedded in a SOAP header) into outgoing CSI credentials (embedded in a GIOP service context). Hence, the SOAP-to-CORBA router enables interoperation of SOAP/HTTP security with CORBA security.

---

## Transferring credentials from SOAP to CORBA

The transferal of credentials from SOAP to CORBA obeys the following semantics:

- Extracting username/password credentials—the router can extract either WSSE username/password from the SOAP header or username/password from the HTTP header. If username/password credentials are sent in both headers, you can influence the priority by setting the `plugins:asp:security_level` configuration variable to one of the following values:
  - ◆ `REQUEST_LEVEL`—give priority to the WSSE username and password from the SOAP header.
  - ◆ `MESSAGE_LEVEL`—give priority to the username and password from the HTTP header.
- The username and password credentials are inserted into GSSUP credentials, which are transmitted using the CSI authentication over transport mechanism.
- The domain name in the GSSUP credentials is set to an empty string (which acts as a wildcard that matches any domain).
- The router does *not* attempt to authenticate the GSSUP credentials. Hence, the router does not call the Artix security service.
- The GSSUP credentials are used for a *single* invocation only.

**Note:** Internally, the GSSUP credentials are set using the `IT_CSI::CSICurrent3::set_effective_own_gssup_credentials_info()` function.

## Router WSDL contract

Example 60 shows the WSDL contract for the SOAP-to-CORBA router.

**Example 60: SOAP-to-CORBA Router WSDL Contract**

```

<?xml version="1.0" encoding="UTF-8"?>
<definitions name="HelloWorldService"
  targetNamespace="http://xmlbus.com/HelloWorld"
  xmlns="http://schemas.xmlsoap.org/wsdl/"
  xmlns:corba="http://schemas.ionac.com/bindings/corba"
  ...
  xmlns:soap="http://schemas.xmlsoap.org/wsdl/soap/"
  ...>
  <types>
    ...
  </types>
  ...
  <portType name="HelloWorldPortType">
    ...
  </portType>

  <binding name="HelloWorldPortBinding"
    type="tns:HelloWorldPortType">
    ...
  </binding>

  <binding name="CORBAHelloWorldBinding"
    type="tns:HelloWorldPortType">
    ...
  </binding>

1  <service name="HelloWorldService">
    <port binding="tns:HelloWorldPortBinding"
      name="HelloWorldPort">
2    <soap:address location="https://localhost:8085"/>
    </port>
  </service>

3  <service name="CORBAHelloWorldService">
    <port binding="tns:CORBAHelloWorldBinding"
      name="CORBAHelloWorldPort">
4    <corba:address
      location="file:../../corba/server/HelloWorld.ior"/>
      <corba:policy/>
    </port>
  </service>

```



**Example 60:** SOAP-to-CORBA Router WSDL Contract

```

5  <ns2:route name="r1">
      <ns2:source      port="HelloWorldPort"
                      service="tns:HelloWorldService"/>
      <ns2:destination port="CORBAHelloWorldPort"
                      service="tns:CORBAHelloWorldService"/>
    </ns2:route>
  </definitions>

```

The preceding router WSDL contract can be explained as follows:

1. The `HelloWorldService` specifies a SOAP/HTTP endpoint for the `HelloWorldPortType` port type.
2. The SOAP/HTTP endpoint has the address, `https://localhost:8085` (you might want to change this to specify the actual name of the host where the router is running).

**Note:** The secure HTTPS protocol is used here (as indicated by the `https` prefix in the URL).

3. The `CORBAHelloWorldService` specifies a CORBA endpoint for the `HelloWorldPortType` port type.
4. The location of the CORBA endpoint is given by a stringified interoperable object reference (IOR), which is stored in the file, `HelloWorld.ior`. The CORBA server is programmed to create this file as it starts up.

**Note:** A more sophisticated alternative for specifying the CORBA endpoint would be to use the CORBA Naming Service.

5. The `route` element sets up a route as follows:
  - ◆ The source endpoint (which receives incoming requests) is the SOAP/HTTP endpoint, `HelloWorldPort`.
  - ◆ The destination endpoint (to which the router sends outgoing requests) is the CORBA endpoint, `CORBAHelloWorldPort`.

**Router configuration**

**Example 61** shows the configuration of the router in this scenario, which uses the `secure_artix.secure_soap_corba.switch.gssup` configuration scope.

**Example 61: SOAP-to-CORBA Router Configuration**

```
# Artix Configuration File
...
secure_artix
{
  secure_soap_corba
  {
    initial_references:IT_SecurityService:reference =
      "corbaloc:it_iopos:1.2@localhost:58482/IT_SecurityService";

    switch
    {
      #####
      # required for token propagation

      # iiop_tls config
1 policies:iiop_tls:trusted_ca_list_policy =
      "C:\artix_30\artix\3.0\demos\security\certificates\tls\x509\t
      rusted_ca_lists\ca_list1.pem";
2 policies:iiop_tls:client_secure_invocation_policy:requires =
      ["Integrity", "Confidentiality", "DetectReplay",
      "DetectMisordering"];
policies:iiop_tls:client_secure_invocation_policy:supports =
      ["Integrity", "Confidentiality", "DetectReplay",
      "DetectMisordering", "EstablishTrustInClient",
      "EstablishTrustInTarget"];
3 principal_sponsor:use_principal_sponsor = "true";
principal_sponsor:auth_method_id = "pkcs12_file";
principal_sponsor:auth_method_data =
      ["filename=router_cert.p12", "password_file=router_cert.pwf"];

      # csi auth config
4 policies:csi:auth_over_transport:client_supports =
      ["EstablishTrustInClient"];
policies:csi:attribute_service:client_supports =
      ["IdentityAssertion"];

      #binding/plugin list
5 orb_plugins = ["xmlfile_log_stream", "iiop_profile",
      "giop", "iiop_tls", "routing", "gsp"];

```

**Example 61: SOAP-to-CORBA Router Configuration**

```

6      plugins:routing:wSDL_url="../../etc/router.wSDL";

      # Secure HTTPS server-side settings
      policies:https:trusted_ca_list_policy =
"C:\artix_30\artix\3.0\demos\security\certificates\openssl\x5
09\ca\cacert.pem";
      policies:target_secure_invocation_policy:requires =
["Confidentiality", "Integrity", "DetectReplay",
"DetectMisordering", "EstablishTrustInClient"];
      policies:target_secure_invocation_policy:supports =
["Confidentiality", "Integrity", "DetectReplay",
"DetectMisordering", "EstablishTrustInClient",
"EstablishTrustInTarget"];

      gssup
      {
          #####
          # flags to control credential propagation
          policies:bindings:corba:token_propagation="false";
          policies:bindings:corba:gssup_propagation="true";
          #####
      };
  };
};
};
};

```

The preceding router configuration can be explained as follows:

1. This trusted CA list policy specifies the CA certificates that are used to check certificates received from the CORBA server during the SSL/TLS handshake.
2. This policy specifies that the router can only open secure IIOP/TLS connections to CORBA servers.
3. The principal sponsor settings associate an X.509 certificate with the Artix router.
4. CSI provides two different mechanisms for transporting credentials, both of which are supported by the router:
  - ◆ *Authorization over transport*—transfers credentials in the form of a username, password and domain name. This is the mechanism used in the current scenario.

- ◆ *Identity assertion*—transfers credentials in the form of an asserted identity. This is the mechanism that is used in combination with single sign-on—see [“Single Sign-On SOAP-to-CORBA Scenario” on page 338](#).
5. The `iiop_tls` plug-in enables secure IIOP/TLS communication. The `at_http` plug-in and the `https` plug-in are loaded implicitly, because they are required by the `HelloWorldService` service in the WSDL contract.
  6. This line specifies the location of the router WSDL contract.
  7. The token propagation option is disabled in this scenario.
  8. The GSSUP propagation option is enabled in this scenario. This is the key setting for enabling security interoperability. The CORBA binding extracts the username and password credentials from incoming SOAP/HTTP invocations and inserts them into an outgoing GSSUP credentials object, to be transmitted using CSI authentication over transport. The domain name in the outgoing GSSUP credentials is set to a blank string.

## CORBA Server

### Overview

In this scenario, the CORBA server must be configured to accept GSSUP credentials through the CSI authentication over transport mechanism. This subsection describes how to configure the CORBA server to authenticate the received CSI credentials.

### Server configuration

[Example 62](#) shows the configuration of the CORBA server in this scenario, which uses the `secure_artix.secure_soap_corba.server.gssup` configuration scope.

#### Example 62: CORBA Server Supporting GSSUP Credentials

```
secure_artix
{
  secure_soap_corba
  {
    initial_references:IT_SecurityService:reference =
"corbaloc:it_iops:1.2@localhost:58482/IT_SecurityService";

    server
    {

      # binding/plugin list
      orb_plugins = ["local_log_stream", "iiop_profile",
"giop", "iiop_tls", "gsp"];
      binding:server_binding_list = ["CSI+GSP", "CSI", "GSP"];

      # disable authorization
1      plugins:gsp:enable_authorization="false";

      # disable client side caching
2      # plugins:gsp:authentication_cache_size = "-1";
      # plugins:gsp:authentication_cache_timeout = "0";

      # csi auth config
3      policies:csi:auth_over_transport:server_domain_name =
"PCGROUP";
      policies:csi:attribute_service:target_supports =
["IdentityAssertion"];
```

**Example 62:** CORBA Server Supporting GSSUP Credentials

```

# iiop_tls config
policies:iiop_tls:trusted_ca_list_policy =
  "C:\artix_30\artix\3.0\demos\security\certificates\tls\x509\t
  rusted_ca_lists/ca_list1.pem";
4 policies:iiop_tls:target_secure_invocation_policy:supports =
  ["Integrity", "Confidentiality", "DetectReplay",
  "DetectMisordering", "EstablishTrustInTarget",
  "EstablishTrustInClient"];
policies:iiop_tls:target_secure_invocation_policy:requires =
  ["Integrity", "Confidentiality", "DetectReplay",
  "DetectMisordering", "EstablishTrustInClient"];
5   principal_sponsor:use_principal_sponsor = "true";
   principal_sponsor:auth_method_id = "pkcs12_file";
   principal_sponsor:auth_method_data =
  ["filename=server_cert.p12","password_file=server_cert.pwf"];

# Configuration required for Token propagation.
6   plugins:gsp:accept_asserted_authorization_info =
  "false";

# Configuration required for GSSUP propagation.
7   policies:csi:auth_over_transport:target_requires =
  ["EstablishTrustInClient"];
   policies:csi:auth_over_transport:target_supports =
  ["EstablishTrustInClient"];
   };
};
};

```

The preceding server configuration can be described as follows:

1. In this example, authorization is disabled for simplicity. You can enable authorization, however, if your application requires it.
2. You might want to disable client side caching for testing purposes (this would force the server to contact the security service with every invocation). Normally, however, you should leave these lines commented out, as shown here. Client caching improves performance considerably.
3. If needed for authorization purposes, you can set the domain name here.

4. These settings for the IOP/TLS target secure invocation policy ensure that the server accepts only secure connections. The server also requires the `EstablishTrustInClient` association option, which implies that clients must provide an X.509 certificate during the SSL/TLS handshake.
5. The principal sponsor settings associate an X.509 certificate (in PKCS#12 format) with the CORBA server.
6. If the server receives credentials in the form of an SSO token, this setting ensures that the server re-authenticates the token, instead of relying on SAML data propagated with the request.
7. These CSI authorization over transport policies require clients to provide GSSUP credentials, which contain a username, password and domain name. The `gsp` plug-in is then responsible for contacting the Artix security service to authenticate these credentials.

---

# Single Sign-On SOAP-to-CORBA Scenario

---

## Overview

This section describes how to integrate a single sign-on SOAP client with a secure CORBA server, by interposing a suitably configured SOAP-to-CORBA Artix router.

---

## In this section

This section contains the following subsections:

<a href="#">Overview of the Secure SSO SOAP-to-CORBA Scenario</a>	<a href="#">page 339</a>
<a href="#">SSO SOAP Client</a>	<a href="#">page 341</a>
<a href="#">SSO SOAP-to-CORBA Router</a>	<a href="#">page 343</a>



## Overview of the Secure SSO SOAP-to-CORBA Scenario

### Overview

This subsection describes a variation of the secure SOAP-to-CORBA scenario, where the client is configured to use *single sign-on* (SSO). In this scenario, the client authenticates the username and password with the login service prior to sending an invocation to the router. Instead of sending username and password credentials to the router, the client sends the SSO token it received from the login service. The router can then be configured to propagate the SSO token to the remote CORBA server.

### SSO SOAP-to-CORBA scenario

Figure 39 shows the outline of a scenario where an SSO token, embedded in a SOAP header, is transformed into a CSI identity token, embedded in a GIOP header (GIOP service context).

Figure 39: Propagating an SSO Token Across a SOAP-to-CORBA Router

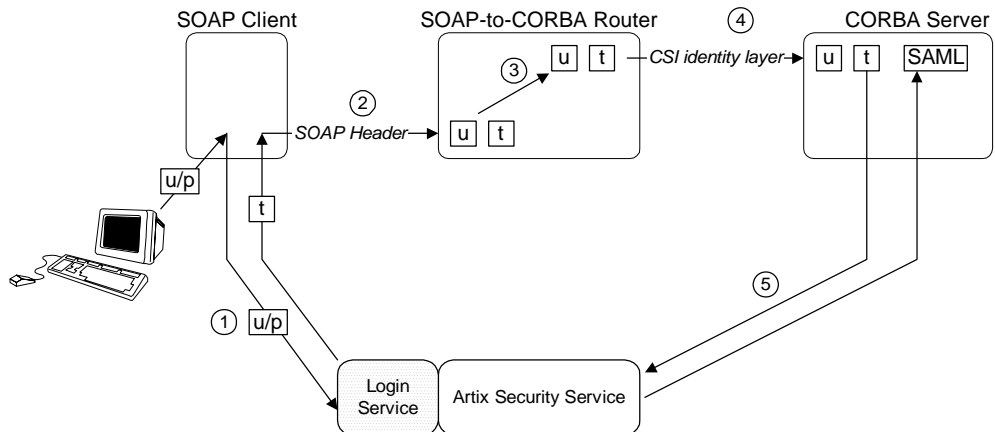

**Steps**

The steps for propagating credentials across the SOAP-to-CORBA router, as shown in [Figure 38](#), can be described as follows:

Stage	Description
1	When single sign-on is enabled, the client calls out to the login service, passing in the client's WSSE credentials, $u/p$ , in order to obtain an SSO token.
2	When the client invokes an operation on the router, the SSO token, $t$ , is sent as the password in the WSSE credentials.
3	The router extracts the username, $u$ , and the SSO token, $t$ , from the received WSSE credentials and then inserts the username into the outgoing CSI identity token. <b>Note:</b> The router should <i>not</i> attempt to authenticate the received SSO token. In the current example, authentication does not occur, because the router does not load the <code>artix_security</code> plug-in.
4	The username, $u$ , is sent on to the CORBA server using the CSI identity assertion mechanism. The SSO token, $t$ , is transmitted to the CORBA server in a proprietary GIOP service context.
5	The CORBA server re-authenticates the client's SSO token, $t$ , by calling out to the Artix security service. The return value contains the SAML role and realm data for the token.

**Demonstration code**

Demonstration code for the SSO SOAP-to-CORBA scenario is available from the following location:

```
ArtixInstallDir/artix/Version/demos/security/secure_soap_corba
```

**Enabling token propagation**

To enable SSO token propagation (where received SSO tokens are inserted into the outgoing CSI identity token by the router), set the following router configuration variable to `true`:

```
policies:bindings:corba:token_propagation = "true";
```

## SSO SOAP Client

### Overview

This subsection describes how to configure a SOAP client to use single sign-on. The initial client credentials are a WSSE username and password (programmed as shown in [“Setting the WSSE username and password” on page 325](#)). After contacting the login service, however, the client uses an SSO token as its credentials for subsequent invocations.

### SSO client configuration

[Example 63](#) shows the configuration of the single sign-on SOAP client, which uses the `secure_artix.secure_soap_corba.client.token` configuration scope.

#### Example 63: Single Sign-On SOAP Client Configuration

```
# Artix Configuration File
...
secure_artix
{
    secure_soap_corba
    {
        initial_references:IT_SecurityService:reference =
        "corbaloc:it_iops:1.2@localhost:58482/IT_SecurityService";

        client
        {
            # Secure HTTPS client-side configuration
            policies:https:trusted_ca_list_policy =
            "C:\artix_30\artix\3.0\demos\security\certificates\tls\x509\t
            rusted_ca_lists\ca_list1.pem";
            policies:client_secure_invocation_policy:requires =
            ["Confidentiality", "Integrity", "DetectReplay",
            "DetectMisordering", "EstablishTrustInTarget"];
            policies:client_secure_invocation_policy:supports =
            ["Confidentiality", "Integrity", "DetectReplay",
            "DetectMisordering", "EstablishTrustInClient",
            "EstablishTrustInTarget"];

            principal_sponsor:use_principal_sponsor = "true";
            principal_sponsor:auth_method_id = "pkcs12_file";
            principal_sponsor:auth_method_data =
            ["filename=C:\artix_30\artix\3.0\demos\security\certificates/
            openssl\x509\certs\testaspen.p12", "password=testaspen"];
        }
    }
}
```

**Example 63:** *Single Sign-On SOAP Client Configuration*

```

...
token
{
1   orb_plugins = ["xmlfile_log_stream",
"login_client", "https"];
2   binding:artix:client_request_interceptor_list=
"login_client";
3   bus:initial_contract:url:login_service =
"../../wsdl/login_service.wsdl";
   };
};

```

The preceding configuration can be explained as follows:

1. To enable the single sign-on functionality in the client, add the `login_client` plug-in to the list of ORB plug-ins.
2. It is also necessary to add `login_client` to the Artix client request interceptor list (the single sign-on functionality is implemented by a client request interceptor).
3. The `bus:initial_contract:url:login_service` variable specifies the location of the login service's WSDL contract. This contract contains the address of the login service endpoint.

---

## SSO SOAP-to-CORBA Router

---

### Overview

The single sign-on SOAP-to-CORBA router is configured similarly to the normal SOAP-to-CORBA router ([“SOAP-to-CORBA Router” on page 329](#)), except that the CORBA binding is configured to enable token propagation instead of GSSUP propagation.

---

### Transferring credentials from SOAP to CORBA

The transfer of credentials from SOAP to CORBA in the single sign-on scenario obeys the following semantics:

- The SSO token credentials are inserted into a proprietary GIOP service context, which is transmitted in the header of the outgoing IIOP/TLS message.
  - The router does *not* attempt to authenticate the SSO token. Hence, the router does not call the Artix security service.
  - The SSO token is used for a *single* invocation only.
- 

### SSO router configuration

[Example 64](#) shows the configuration of the single sign-on router, which uses the `secure_artix.secure_soap_corba.switch.token` configuration scope.

#### Example 64: Single Sign-On SOAP-to-CORBA Router Configuration

```
# Artix Configuration File
secure_artix
{
  secure_soap_corba
  {
    initial_references:IT_SecurityService:reference =
      "corbaloc:it_iiops:1.2@localhost:58482/IT_SecurityService";

    switch
    {
1      # Common configuration
      ...
2      policies:csi:attribute_service:client_supports =
["IdentityAssertion"];
      ...
      token
```

**Example 64:** *Single Sign-On SOAP-to-CORBA Router Configuration*

```

3      {
4          policies:bindings:corba:token_propagation="true";
          policies:bindings:corba:gssup_propagation="false";
          };
          ...
      };
  };
};

```

The preceding router configuration can be explained as follows:

1. The rest of the `secure_artix.secure_soap_corba.switch` scope is the same as the scenario without single sign-on. See [“SOAP-to-CORBA Router” on page 329](#) for details.
2. This line is of particular importance for the single sign-on scenario. It enables the CSI identity assertion mechanism, which is needed to transmit the SSO token to the CORBA server.
3. The token propagation option is enabled in this scenario. This is the key setting for enabling security interoperability. The CORBA binding extracts the SSO token from incoming SOAP/HTTP invocations and inserts the token into an outgoing IIOB request, to be transmitted using CSI identity assertion.
4. The GSSUP propagation option is disabled in this scenario.

---

# CORBA-to-SOAP Scenario

---

## Overview

This section describes how to integrate a secure CORBA client with a secure SOAP server, by interposing a suitably configured CORBA-to-SOAP Artix router. The router transforms the CORBA client's CSI/GSSUP credentials (consisting of username, password, and domain) into WSSE credentials (consisting of username and password) for the SOAP server.

---

## In this section

This section contains the following subsections:

<a href="#">Overview of the Secure CORBA-to-SOAP Scenario</a>	<a href="#">page 346</a>
<a href="#">CORBA Client</a>	<a href="#">page 348</a>
<a href="#">CORBA-to-SOAP Router</a>	<a href="#">page 350</a>
<a href="#">SOAP Server</a>	<a href="#">page 356</a>

## Overview of the Secure CORBA-to-SOAP Scenario

### Overview

This subsection describes a secure CORBA-to-SOAP scenario, where the router is configured to integrate CORBA security with SOAP security. The key functionality provided by the router in this scenario is the ability to extract CORBA CSI credentials (provided in the form of a GSSUP username, password, and domain) and propagate them as SOAP-compatible WSSE credentials.

### SOAP-to-CORBA scenario

Figure 40 shows the outline of a scenario where GSSUP credentials, embedded in a GIOP service context, are transformed into WSSE username and password credentials, embedded in a SOAP header.

**Figure 40:** *Propagating Credentials Across a CORBA-to-SOAP Router*

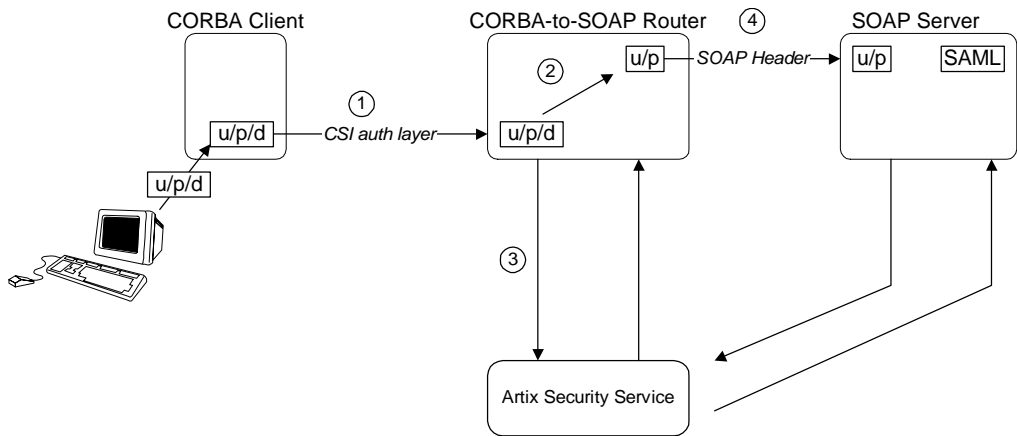



**Steps**

The steps for propagating credentials across the CORBA-to-SOAP router, as shown in [Figure 40](#), can be described, as follows:

Stage	Description
1	The client initializes the GSSUP username, password, and domain credentials, $u/p/d$ , and sends these credentials, embedded in a GIOP service context, across to the router.
2	The router extracts the received GSSUP username, password, and domain credentials, $u/p/d$ , and transfers them into WSSE credentials, consisting of a username and a password. The domain name is discarded.
3	The WSSE credentials, $u/p$ , are sent on to the SOAP server inside a WSSE SOAP header.
4	The SOAP server authenticates the received WSSE credentials, $u/p$ , by calling out to the Artix security service (this step is performed automatically by the <code>artix_security</code> plug-in).

**Demonstration code**

Demonstration code for this CORBA-to-SOAP scenario is available from the following location:

```
ArtixInstallDir/artix/Version/demos/security/secure_corba_soap
```

**Enabling WSSE propagation**

To enable WSSE propagation (where received username and password credentials are inserted into the outgoing GSSUP credentials by the router), set the following router configuration variable to `true`:

```
policies:bindings:soap:gssup_propagation = "true";
```

**Enabling token propagation**

Additionally, you can enable Artix security token propagation by setting the following router configuration variable to `true`:

```
policies:bindings:soap:token_propagation = "true";
```

## CORBA Client

### Overview

This section describes how to configure a CORBA client to send username and password credentials through the CSI authentication over transport mechanism (which puts the user's credentials into a GIOP service context). When a client request arrives in the router, the propagation mechanism in the router extracts the username and password from the incoming CSI credentials.

### Client configuration

[Example 65](#) shows the configuration of the SOAP client in this scenario, which uses the `secure_artix.secure_corba_soap.client` configuration scope.

#### Example 65: SOAP Client Configuration

```
# Artix Configuration File
...
secure_artix
{
  secure_soap_corba
  {
    client
    {
      # iiop_tls config
1      policies:iiop_tls:client_secure_invocation_policy:requires
      = ["Integrity", "Confidentiality", "DetectReplay",
        "DetectMisordering"];

      # csi auth config
2      policies:csi:auth_over_transport:authentication_service
      = "com.iona.corba.security.csi.AuthenticationService";
      policies:csi:auth_over_transport:client_supports =
      ["EstablishTrustInClient"];
      policies:csi:attribute_service:client_supports =
      ["IdentityAssertion"];

      #binding/plugin list
3      orb_plugins = ["xmlfile_log_stream", "iiop_profile",
        "giop", "iiop_tls", "csi"];

4      principal_sponsor:use_principal_sponsor = "true";
      principal_sponsor:auth_method_id = "pkcs12_file";
    }
  }
}
```



---

## CORBA-to-SOAP Router

---

### Overview

The CORBA-to-SOAP router receives incoming IIOP requests, translates them into SOAP/HTTP requests and then forwards them on to a SOAP server. In addition to translating requests, the router is also configured to transfer the incoming CSI credentials (embedded in a GIOP message context) into outgoing WSSE credentials (embedded in a SOAP header). Hence, the CORBA-to-SOAP router enables interoperation of CORBA security with SOAP/HTTP security.

---

### Transferring credentials from CORBA to SOAP

The transferal of credentials from CORBA to SOAP obeys the following semantics:

- The router authenticates the incoming CSI credentials, obtaining a security token from the Artix security service.
  - The router embeds the security token in the outgoing SOAP header.
  - The username from the incoming CSI credentials is embedded in the outgoing SOAP header (in the WSSE credentials).
  - The domain name from the incoming CSI credentials is discarded (the WSSE credentials do not include a domain name).
- 

### Router WSDL contract

[Example 66](#) shows the WSDL contract for the CORBA-to-SOAP router.

#### **Example 66:** *CORBA-to-SOAP Router WSDL Contract*

```
<?xml version="1.0" encoding="UTF-8"?>
<definitions name="HelloWorldService"
  targetNamespace="http://xmlbus.com/HelloWorld"
  xmlns="http://schemas.xmlsoap.org/wsd1/"
  xmlns:corba="http://schemas.ionac.com/bindings/corba"
  ...
  xmlns:soap="http://schemas.xmlsoap.org/wsd1/soap/"
  ...>
<types>
  ...
</types>
...
<portType name="HelloWorldPortType">
  ...
```

**Example 66:** CORBA-to-SOAP Router WSDL Contract

```

    </portType>

    <binding name="HelloWorldPortBinding"
            type="tns:HelloWorldPortType">
        ...
    </binding>

    <binding name="CORBAHelloWorldBinding"
            type="tns:HelloWorldPortType">
        ...
    </binding>

1  <service name="HelloWorldService">
    <port binding="tns:HelloWorldPortBinding"
          name="HelloWorldPort">
2      <soap:address location="https://localhost:8085"/>
    </port>
    </service>

3  <service name="CORBAHelloWorldService">
    <port binding="tns:CORBAHelloWorldBinding"
          name="CORBAHelloWorldPort">
4      <corba:address
          location="file:../../corba/server/HelloWorld.ior"/>
        <corba:policy/>
    </port>
    </service>

5  <ns2:route name="r1">
    <ns2:source      port="CORBAHelloWorldPort"
                    service="tns:CORBAHelloWorldService"/>
    <ns2:destination port="HelloWorldPort"
                    service="tns:HelloWorldService"/>
    </ns2:route>
</definitions>

```

The preceding router WSDL contract can be explained as follows:

1. The `HelloWorldService` specifies a SOAP/HTTP endpoint for the `HelloWorldPortType` port type.
2. The SOAP/HTTP endpoint has the address, `https://localhost:8085` (you might want to change this to specify the actual name of the host where the SOAP server is running).

**Note:** The secure HTTPS protocol is used here (as indicated by the `https` prefix in the URL).

3. The `CORBAHelloWorldService` specifies a CORBA endpoint for the `HelloWorldPortType` port type.
4. The location of the CORBA endpoint is given by a stringified interoperable object reference (IOR). The router automatically opens an IP listener port and writes the corresponding IOR into the `HelloWorld.ior` file.

**Note:** A more sophisticated alternative for publishing the CORBA endpoint would be to use the CORBA Naming Service.

5. The `route` element sets up a route as follows:
  - ◆ The source endpoint (which receives incoming requests) is the CORBA endpoint, `CORBAHelloWorldPort`.
  - ◆ The destination endpoint (to which the router sends outgoing requests) is the SOAP/HTTP endpoint, `HelloWorldPort`.

## Router configuration

**Example 67** shows the configuration of the router in this scenario, which uses the `secure_artix.secure_corba_soap.switch` configuration scope.

### **Example 67:** CORBA-to-SOAP Router Configuration

```
# Artix Configuration File
...
secure_artix
{
  secure_soap_corba
  {
    initial_references:IT_SecurityService:reference =
"corbaloc:it_iiops:1.2@localhost:58482/IT_SecurityService";
```

**Example 67:** CORBA-to-SOAP Router Configuration

```

switch
{
  # disable authorization
1   plugins:gsp:enable_authorization="false";

  # iiop_tls config
2
  policies:iiop_tls:client_secure_invocation_policy:requires =
  ["Integrity", "Confidentiality", "DetectReplay",
  "DetectMisordering"];

  policies:iiop_tls:target_secure_invocation_policy:requires =
  ["Integrity", "Confidentiality", "DetectReplay",
  "DetectMisordering"];

3   principal_sponsor:use_principal_sponsor = "true";
   principal_sponsor:auth_method_id = "pkcs12_file";
   principal_sponsor:auth_method_data =
  ["filename=C:\artix_40\artix\4.0\demos\security\certificates\
  tls\x509\certs\services\administrator.p12",
  "password_file=C:\artix_40\artix\4.0\demos\security\certifica
  tes\tls\x509\certs\services\administrator.pwf"];

  # csi auth config
4   policies:csi:attribute_service:target_supports =
  ["IdentityAssertion"];
   policies:csi:auth_over_transport:target_requires =
  ["EstablishTrustInClient"];
   policies:csi:auth_over_transport:target_supports =
  ["EstablishTrustInClient"];

  #binding/plugin list
5   orb_plugins = ["xmlfile_log_stream", "iiop_profile",
  "giop", "iiop_tls", "routing", "gsp"];
   binding:server_binding_list = ["CSI+GSP", "CSI",
  "GSP"];

6   plugins:routing:wSDL_url="../../etc/router.wSDL";

   plugins:xmlfile_log_stream:use_pid = "true";

```

**Example 67: CORBA-to-SOAP Router Configuration**

```

7      # secure HTTPS client -> secure HTTPS server settings
      plugins:at_http:client:use_secure_sockets="true";
      plugins:at_http:client:trusted_root_certificates =
"C:\artix_40\artix\4.0\demos\security\certificates\openssl\x5
09/ca/cacert.pem";
      plugins:at_http:client:client_certificate =
"C:\artix_40\artix\4.0\demos\security\certificates\openssl\x5
09/certs/testaspen.p12";
      plugins:at_http:client:client_private_key_password =
"testaspen";

8      policies:bindings:soap:token_propagation = "true";
      policies:bindings:soap:gssup_propagation = "true";
    };
  };
};

```

The preceding router configuration can be explained as follows:

1. There is no need for the router to perform authorization on incoming CORBA messages. Therefore, it makes sense to disable authorization in the GSP plug-in (which is responsible for the authentication and authorization of CORBA messages).
2. The IIOP/TLS client and target invocation policies specified here ensure that both outgoing and incoming IIOP/TLS connections are secure.
3. The principal sponsor settings associate an X.509 certificate with the Artix router.
4. The following three lines specify the basic CSI configuration on the client side, enabling both CSI authentication over transport and CSI identity assertion.
5. The `gsp` plug-in must be included in the `orb_plugins` list to enable the router to parse incoming CSI credentials and to authenticate the CSI credentials with the Artix security service.
6. This line specifies the location of the router WSDL contract.
7. The following four lines configure security for the HTTPS transport. In particular, the `plugins:at_http:client:client_certificate` configuration variable specifies an own X.509 certificate to use specifically with the HTTPS transport.



8. The CORBA-to-SOAP GSSUP propagation option is enabled in this scenario.

This is the key setting for enabling security interoperability. The router extracts the username, password, and domain credentials from incoming CORBA invocations and inserts them into an outgoing WSSE credentials object, to be transmitted in a WSSE SOAP header. The domain name from the incoming CORBA message gets discarded.

## SOAP Server

### Overview

In this scenario, the SOAP server must be configured to accept WSSE credentials, which are transmitted in a SOAP header. This subsection describes how to configure the SOAP server to authenticate the received WSSE credentials.

### Server configuration

[Example 68](#) shows the configuration of the SOAP server in this scenario, which uses the `secure_artix.secure_corba_soap.server` configuration scope.

#### Example 68: SOAP Server Supporting WSSE Credentials

```

secure_artix
{
  secure_corba_soap
  {
    initial_references:IT_SecurityService:reference =
"corbaloc:it_iops:1.2@localhost:58482/IT_SecurityService";

    server
    {
1      principal_sponsor:use_principal_sponsor = "true";
      principal_sponsor:auth_method_id = "pkcs12_file";
      principal_sponsor:auth_method_data =
["filename=C:\artix_40\artix\4.0\demos\security\certificates/
tls/x509/certs/services/administrator.p12",
"password_file=C:\artix_40\artix\4.0\demos\security\certifica
tes/tls/x509/certs/services/administrator.pwf"];
2
      policies:target_secure_invocation_policy:requires =
["Confidentiality", "Integrity", "DetectReplay",
"DetectMisordering"];
      policies:target_secure_invocation_policy:supports =
["Confidentiality", "Integrity", "DetectReplay",
"DetectMisordering", "EstablishTrustInClient",
"EstablishTrustInTarget"];

      binding:artix:server_request_interceptor_list=
"security";
3      orb_plugins = ["xmlfile_log_stream", "iiop_profile",
"giop", "iiop_tls", "artix_security"];
    }
  }
}

```

**Example 68: SOAP Server Supporting WSSE Credentials**

```

4         policies:asp:enable_authorization = "false";
5         plugins:asp:security_level = "REQUEST_LEVEL";

6         plugins:at_http:server:trusted_root_certificates =
"C:\artix_40\artix\4.0\demos\security\certificates\openssl\x5
09/ca/cacert.pem";
         plugins:at_http:server:server_certificate =
"C:\artix_40\artix\4.0\demos\security\certificates\openssl\x5
09/certs/testaspen.p12";
         plugins:at_http:server:server_private_key_password =
"testaspen";
         };
    };
};

```

The preceding server configuration can be described as follows:

1. The principal sponsor settings associate an X.509 certificate with the SOAP server. This certificate is used when opening a connection to the Artix security service (this connection uses the IIOP/TLS protocol).
2. The target invocation policies specified here ensure that incoming connections are secure, for both the IIOP/TLS and HTTPS protocols.
3. You must include the `artix_security` plug-in in the `orb_plugins` list to enable Artix security. The `iiop_tls` plug-in is required in order to communicate with the Artix security service. In addition, the `at_http` plug-in and the `https` plug-in are loaded, but there is no need to include `at_http` or `https` in the `orb_plugins` list. Because the HTTPS port is specified in the WSDL contract, Artix implicitly loads the `at_http` and `https` plug-ins.
4. In this example, authorization is disabled. In most deployed systems, however, you would probably need to enable authorization (and add the additional configuration settings—see [“Security Layer” on page 18](#)).
5. By setting the security level to `REQUEST_LEVEL`, you indicate that the credentials to authenticate are taken preferentially from the SOAP header (for example, the WSSE credentials).

6. These settings specify an own X.509 certificate that is used with the HTTPS protocol only.

# Programming Authentication

*To ensure that Web services and Web service clients developed using Artix can interoperate with the widest possible array of Web services, Artix supports the WS Security specification for propagating Kerberos security tokens, username/password security tokens and X.509 certificates in SOAP message headers. The security tokens are placed into the SOAP message header using Artix APIs that format the tokens and place them in the header correctly.*

---

**In this chapter**

This chapter discusses the following topics:

<a href="#">Propagating a Username/Password Token</a>	<a href="#">page 360</a>
<a href="#">Propagating a Kerberos Token</a>	<a href="#">page 365</a>
<a href="#">Propagating an X.509 Certificate</a>	<a href="#">page 370</a>

---

# Propagating a Username/Password Token

---

## Overview

Many Web services use simple username/password authentication to ensure that only preapproved clients can access them. Artix provides a simple client side API for embedding the username and password into the SOAP message header of requests in a WS Security compliant manner.

---

## C++ Procedure

Embedding a username and password token into the SOAP header of a request in Artix C++ requires you to do the following:

1. Make sure that your application makefile is configured to link with the `it_context_attribute` library (`it_context_attribute.lib` on Windows and `it_context_attribute.so` or `it_context_attribute.a` on UNIX) which contains the `bus-security` context stub code.
  2. Get a reference to the current `IT_ContextAttributes::BusSecurity` context data type, using the Artix context API (see *Developing Artix Applications in C++*).
  3. Set the `WSSEUsernameToken` property on the `BusSecurity` context using the `setWSSEUsernameToken()` method.
  4. Set the `WSSEPasswordToken` property on the `BusSecurity` context using the `setWSSEPasswordToken()` method.
- 

## C++ Example

[Example 69](#) shows how to set the Web services username/password token in a C++ client prior to invoking a remote operation.

### Example 69: Setting a WS Username/Password Token in a C++ Client

```
// C++  
  
#include <it_bus/bus.h>  
#include <it_bus/exception.h>  
#include <it_cal/iostream.h>  
  
// Include header files related to the bus-security context  
#include <it_bus_pdk/context.h>  
#include <it_bus_pdk/context_attrs/bus_security_xsdTypes.h>
```

**Example 69:** *Setting a WS Username/Password Token in a C++ Client*

```

IT_USING_NAMESPACE_STD

using namespace IT_ContextAttributes;
using namespace IT_Bus;

int
main(int argc, char* argv[])
{
    try
    {
        IT_Bus::Bus_var bus = IT_Bus::init(argc, argv);

        ContextRegistry* context_registry =
            bus->get_context_registry();

        // Obtain a reference to the ContextCurrent
        ContextCurrent& context_current =
            context_registry->get_current();

        // Obtain a pointer to the Request ContextContainer
        ContextContainer* context_container =
            context_current.request_contexts();

        // Obtain a reference to the context
1      AnyType* info = context_container->get_context(
            IT_ContextAttributes::SECURITY_SERVER_CONTEXT,
            true
        );

        // Cast the context into a BusSecurity object
2      BusSecurity* bus_security_ctx =
            dynamic_cast<BusSecurity*>(info);

        // Set the WS Username and Password tokens
3      bus_security_ctx->setWSSEUsernameToken("artix_user");
        bus_security_ctx->setWSSEPasswordToken("artix");
        ...
    }
    catch(IT_Bus::Exception& e)
    {
        cout << endl << "Error : Unexpected error occurred!"
            << endl << e.message()
            << endl;
        return -1;
    }
}

```

**Example 69:** *Setting a WS Username/Password Token in a C++ Client*

```

    return 0;
}

```

The preceding code can be explained as follows:

1. Call the `IT_Bus::ContextContainer::get_context()` function to obtain a pointer to a `BusSecurity` object. The first parameter is the `QName` of the `BusSecurity` context and the second parameter is set to `true`, indicating that a context with that `QName` will be created if none already exists.
2. Cast the `IT_Bus::AnyType` instance, `info`, to its derived type, `IT_ContextAttributes::BusSecurity`, which is the bus-security context data type.
3. Use the `BusSecurity` API to set the WSSE username and password tokens. After this point, any SOAP operations invoked from the current thread will include the specified WSSE username and password in the request message.

**Java Procedure**

Embedding a username and password token into the SOAP header of a request in Artix Java requires you to do the following:

1. Create a new `com.iona.schemas.bus.security_context.BusSecurity` context data object.
2. Set the `WSSEUsernameToken` property on the `BusSecurity` context using the `setWSSEUsernameToken()` method.
3. Set the `WSSEPasswordToken` property on the `BusSecurity` context using the `setWSSEPasswordToken()` method.
4. Set the bus-security context for the outgoing request message by calling `setRequestContext()` on an `IonaMessageContext` object (see *Developing Artix Applications in Java*).



## Java Example

[Example 70](#) shows how to set the Web services username/password token in a Java client prior to invoking a remote operation.

**Example 70: Setting a WS Username/Password Token in a Java Client**

```
// Java
import javax.xml.namespace.QName;
import javax.xml.rpc.*;

import com.iona.jbus.Bus;
import com.iona.jbus.ContextRegistry;
import com.iona.jbus.IonaMessageContext;
import com.iona.schemas.bus.security_context.BusSecurity;
...
// Set the BuSecurity Context
//-----
// Insert the following lines of code prior to making a
// WS-secured invocation:

1 BusSecurity security = new BusSecurity();
  security.setWSSEUsernameToken("user_test");
  security.setWSSEPasswordToken("user_password");

2 QName SECURITY_CONTEXT =
    new QName(
        "http://schemas.iona.com/bus/security_context",
        "bus-security"
    );

3 ContextRegistry registry = bus.getContextRegistry();
4 IonaMessageContext contextimpl =
    (IonaMessageContext) registry.getCurrent();
5 contextimpl.setRequestContext(SECURITY_CONTEXT, security);
...

```

1. Create a new `com.iona.schemas.bus.security_context.BusSecurity` object to hold the context data and initialize the `WSSEUsernameToken` and `WSSEPasswordToken` properties on this `BusSecurity` object.
2. Initialize the name of the bus-security context. Because the bus-security context type is pre-registered by the Artix runtime (thus fixing the context name) the bus-security name must be set to the value shown here.

3. The `com.ionajbus.ContextRegistry` object manages all of the context objects for the application.
4. The `com.ionajbus.IonaMessageContext` object returned from `getCurrent()` holds all of the context data objects associated with the current thread.
5. Call `setRequestContext()` to initialize the `bus-security` context for outgoing request messages.

---

# Propagating a Kerberos Token

---

## Overview

Using the Kerberos Authentication Service requires you to make a few changes to your client code. First you need to acquire a valid Kerberos token. Then you need to embed it into the SOAP message header of all the request being made on the secure server.

---

## Acquiring a Kerberos Token

To get a security token from the Kerberos Authentication Service is you must use platform specific APIs and then base64 encode the returned binary token so that it can be placed into the SOAP header.

On UNIX platforms, use the GSS APIs to contact Kerberos and get a token for the service you wish to make requests upon. On Windows platforms, use the Microsoft Security Framework APIs to contact Kerberos and get a token for the service you wish to contact.

---

## C++ embedding the Kerberos token in the SOAP header

Embedding a Kerberos token into the SOAP header of a request using the Artix APIs requires you to do the following:

1. Make sure that your application makefile is configured to link with the `it_context_attribute` library (`it_context_attribute.lib` on Windows and `it_context_attribute.so` or `it_context_attribute.a` on UNIX) which contains the `bus-security` context stub code.
2. Get a reference to the current `IT_ContextAttributes::BusSecurity` context data type, using the Artix context API (see *Developing Artix Applications in C++*).
3. Set the `WSSEKerberosv5SToken` property on the `BusSecurity` context using the `setWSSEKerberosv5SToken()` method.

**C++ Example**

**Example 71** shows how to set the Kerberos token prior to invoking a remote operation.

**Example 71: Setting a Kerberos Token on the Client Side**

```
// C++

#include <it_bus/bus.h>
#include <it_bus/exception.h>
#include <it_cal/iostream.h>

// Include header files related to the bus-security context
#include <it_bus_pdk/context.h>
#include <it_bus_pdk/context_attrs/bus_security_xsdTypes.h>

IT_USING_NAMESPACE_STD

using namespace IT_ContextAttributes;
using namespace IT_Bus;

int
main(int argc, char* argv[])
{
    try
    {
        IT_Bus::Bus_var bus = IT_Bus::init(argc, argv);

        ContextRegistry* context_registry =
            bus->get_context_registry();

        // Obtain a reference to the ContextCurrent
        ContextCurrent& context_current =
            context_registry->get_current();

        // Obtain a pointer to the Request ContextContainer
        ContextContainer* context_container =
            context_current.request_contexts();

        // Obtain a reference to the context
        AnyType* info = context_container->get_context(
            IT_ContextAttributes::SECURITY_SERVER_CONTEXT,
            true
        );
    }
}
```

1

**Example 71:** *Setting a Kerberos Token on the Client Side*

```

2      // Cast the context into a BusSecurity object
      BusSecurity* bus_security_ctx =
          dynamic_cast<BusSecurity*> (info);

      // Set the Kerberos token
3      bus_security_ctx->setWSSEKerberosv5SToken(
          kerberos_token_string
      );
      ...
    }
    catch(IT_Bus::Exception& e)
    {
        cout << endl << "Error : Unexpected error occurred!"
              << endl << e.message()
              << endl;
        return -1;
    }
    return 0;
}

```

The preceding code can be explained as follows:

1. The `IT_Bus::ContextContainer::get_context()` function is called with its second parameter set to `true`, indicating that a context with that name will be created if none already exists.
2. Cast the `IT_Bus::AnyType` instance, `info`, to its derived type, `IT_ContextAttributes::BusSecurity`, which is the bus-security context data type.
3. Use the `BusSecurity` API to set the WSSE Kerberos token, `kerberos_token_string`. The argument to `setWSSEKerberosv5SToken()` is a base-64 encoded Kerberos token received from a Kerberos server.

The next operation invoked from this thread will include the specified Kerberos token in the request message.

## Java embedding the Kerberos token in the SOAP header

Embedding a Kerberos token into the SOAP header of a request in Artix Java requires you to do the following:

1. Create a new `com.iona.schemas.bus.security_context.BusSecurity` context data object.
2. Set the `WSSEKerberosv2SToken` property on the `BusSecurity` context using the `setWSSEKerberosv2SToken()` method.
3. Set the bus-security context for the outgoing request message by calling `setRequestContext()` on an `IonaMessageContext` object (see *Developing Artix Applications in Java*).

## Java Example

[Example 72](#) shows how to set the Kerberos token in a Java client prior to invoking a remote operation.

### Example 72: Setting a Kerberos Token in a Java Client

```
// Java
import javax.xml.namespace.QName;
import javax.xml.rpc.*;

import com.iona.jbus.Bus;
import com.iona.jbus.ContextRegistry;
import com.iona.jbus.IonaMessageContext;
import com.iona.schemas.bus.security_context.BusSecurity;
...
// Set the BuSecurity Context
//-----
// Insert the following lines of code prior to making a
// WS-secured invocation:

1 BusSecurity security = new BusSecurity();
  security.setWSSEKerberosv5SToken(kerberos_token_string);

2 QName SECURITY_CONTEXT =
    new QName (
        "http://schemas.iona.com/bus/security_context",
        "bus-security"
    );

3 ContextRegistry registry = bus.getContextRegistry();
4 IonaMessageContext contextimpl =
    (IonaMessageContext)registry.getCurrent();
5 contextimpl.setRequestContext(SECURITY_CONTEXT, security);
```

**Example 72: Setting a Kerberos Token in a Java Client**

...

1. Create a new `com.iona.schemas.bus.security_context.BusSecurity` object to hold the context data and initialize the `WSSEKerberosv2SToken` on this `BusSecurity` object.  
The argument to `setWSSEKerberosv5SToken()` is a base-64 encoded Kerberos token received from a Kerberos server.
2. Initialize the name of the bus-security context. Because the bus-security context type is pre-registered by the Artix runtime (thus fixing the context name) the bus-security name must be set to the value shown here.
3. The `com.iona.jbus.ContextRegistry` object manages all of the context objects for the application.
4. The `com.iona.jbus.IonaMessageContext` object returned from `getCurrent()` holds all of the context data objects associated with the current thread.
5. Call `setRequestContext()` to initialize the bus-security context for outgoing request messages.

---

# Propagating an X.509 Certificate

---

## Overview

Artix lets you propagate an X.509 certificate inside a SOAP header, as specified in the WSSE standard. You need to program the client to insert a certificate into outgoing SOAP headers and program the server to extract the certificate from the incoming SOAP headers.

---

## C++ Procedure

Embedding an X.509 certificate into the SOAP header of a request in Artix C++ requires you to do the following:

1. Make sure that your application makefile is configured to link with the `it_context_attribute` library (`it_context_attribute.lib` on Windows and `it_context_attribute.so` or `it_context_attribute.a` on UNIX) which contains the `bus-security` context stub code.
  2. Get a reference to the current `IT_ContextAttributes::BusSecurity` context data type, using the Artix context API (see *Developing Artix Applications in C++*).
  3. Set the `WSSEX509Cert` property on the `BusSecurity` context using the `setWSSEX509Cert()` method.
  4. Set the `WSSEX509Cert` property on the `BusSecurity` context using the `setWSSEX509Cert()` method.
- 

## C++ Example

[Example 73](#) shows how to insert an X.509 certificate into a WSSE SOAP header in a C++ client prior to invoking a remote operation.

### Example 73: Setting a WSSE X.509 Certificate in a C++ Client

```
// C++

#include <it_bus/bus.h>
#include <it_bus/exception.h>
#include <it_cal/iostream.h>

// Include header files related to the bus-security context
#include <it_bus_pdk/context.h>
#include <it_bus_pdk/context_attrs/bus_security_xsdTypes.h>
```



**Example 73: Setting a WSSE X.509 Certificate in a C++ Client**

```

IT_USING_NAMESPACE_STD

using namespace IT_ContextAttributes;
using namespace IT_Bus;

int
main(int argc, char* argv[])
{
    try
    {
        IT_Bus::Bus_var bus = IT_Bus::init(argc, argv);

        ContextRegistry* context_registry =
            bus->get_context_registry();

        // Obtain a reference to the ContextCurrent
        ContextCurrent& context_current =
            context_registry->get_current();

        // Obtain a pointer to the Request ContextContainer
        ContextContainer* context_container =
            context_current.request_contexts();

        // Obtain a reference to the context
1      AnyType* info = context_container->get_context(
            IT_ContextAttributes::SECURITY_SERVER_CONTEXT,
            true
        );

        // Cast the context into a BusSecurity object
2      BusSecurity* bus_security_ctx =
            dynamic_cast<BusSecurity*>(info);

        // Set the WSSE X.509 Certificate
3      IT_Bus::String x509_cert = ... // Get X.509 cert.
        bus_security_ctx->setWSSEX509Cert(x509_cert);
        ...
    }
    catch(IT_Bus::Exception& e)
    {
        cout << endl << "Error : Unexpected error occurred!"
            << endl << e.message()
            << endl;
        return -1;
    }
}

```

**Example 73:** *Setting a WSSE X.509 Certificate in a C++ Client*

```

    return 0;
}

```

The preceding code can be explained as follows:

1. Call the `IT_Bus::ContextContainer::get_context()` function to obtain a pointer to a `BusSecurity` object. The first parameter is the `QName` of the `BusSecurity` context and the second parameter is set to `true`, indicating that a context with that `QName` will be created if none already exists.
2. Cast the `IT_Bus::AnyType` instance, `info`, to its derived type, `IT_ContextAttributes::BusSecurity`, which is the bus-security context data type.
3. Use the `BusSecurity` API to set the X.509 certificate for sending in the WSSE SOAP header. After this point, any SOAP operations invoked from the current thread will include the specified WSSE X.509 certificate in the request message.

**Java Procedure**

Embedding an X.509 certificate into the SOAP header of a request in Artix Java requires you to do the following:

1. Create a new `com.iona.schemas.bus.security_context.BusSecurity` context data object.
2. Set the `WSSEX509Cert` property on the `BusSecurity` context using the `setWSSEX509Cert()` method.
3. Set the bus-security context for the outgoing request message by calling `setRequestContext()` on an `IonaMessageContext` object (see *Developing Artix Applications in Java*).

**Java Example**

[Example 74](#) shows how to insert an X.509 certificate into a WSSE SOAP header in a Java client prior to invoking a remote operation.

**Example 74:** *Setting a WSSE X.509 Certificate in a Java Client*

```

// Java
import javax.xml.namespace.QName;
import javax.xml.rpc.*;

```

**Example 74:** *Setting a WSSE X.509 Certificate in a Java Client*

```

import com.ionajbus.Bus;
import com.ionajbus.ContextRegistry;
import com.ionajbus.IonaMessageContext;
import com.ionajbus.schemas.bus.security_context.BusSecurity;
...
// Set the BuSecurity Context
//-----
// Insert the following lines of code prior to making a
// WS-secured invocation:

1 BusSecurity security = new BusSecurity();
  java.lang.String x509_cert = ... // Get X.509 cert.
  security.setWSSEX509Cert(x509_cert);

2 QName SECURITY_CONTEXT =
    new QName(
        "http://schemas.ionajbus.com/bus/security_context",
        "bus-security"
    );

3 ContextRegistry registry = bus.getContextRegistry();
4 IonaMessageContext contextimpl =
    (IonaMessageContext) registry.getCurrent();
5 contextimpl.setRequestContext(SECURITY_CONTEXT, security);
...

```

1. Use the `BusSecurity` API to set the X.509 certificate in the WSSE SOAP header.
2. Initialize the name of the bus-security context. Because the bus-security context type is pre-registered by the Artix runtime (thus fixing the context name) the bus-security name must be set to the value shown here.
3. The `com.ionajbus.ContextRegistry` object manages all of the context objects for the application.
4. The `com.ionajbus.IonaMessageContext` object returned from `getCurrent()` holds all of the context data objects associated with the current thread.
5. Call `setRequestContext()` to initialize the bus-security context for outgoing request messages.



# Developing an iSF Adapter

*An iSF adapter is a replaceable component of the iSF server module that enables you to integrate iSF with any third-party enterprise security service. This chapter explains how to develop and configure a custom iSF adapter implementation.*

---

## In this chapter

This chapter discusses the following topics:

<a href="#">iSF Security Architecture</a>	<a href="#">page 376</a>
<a href="#">iSF Server Module Deployment Options</a>	<a href="#">page 380</a>
<a href="#">iSF Adapter Overview</a>	<a href="#">page 382</a>
<a href="#">Implementing the IS2Adapter Interface</a>	<a href="#">page 383</a>
<a href="#">Deploying the Adapter</a>	<a href="#">page 393</a>

# iSF Security Architecture

---

## Overview

This section introduces the basic components and concepts of the iSF security architecture, as follows:

- [Architecture.](#)
- [iSF client.](#)
- [iSF client SDK.](#)
- [Artix Security Service.](#)
- [iSF adapter SDK.](#)
- [iSF adapter.](#)
- [Example adapters.](#)

## Architecture

Figure 41 gives an overview of the Artix Security Service, showing how it fits into the overall context of a secure system.

**Figure 41:** Overview of the Artix Security Service

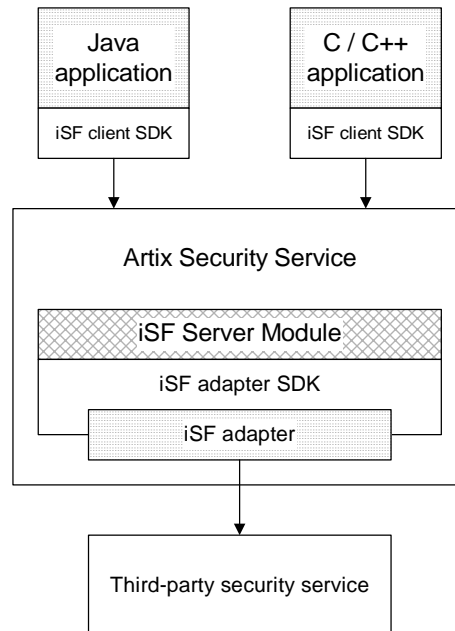

## iSF client

An iSF client is an application that communicates with the Artix Security Service to perform authentication and authorization operations. The following are possible examples of iSF client applications:

- CORBA servers.
- Artix servers.
- Any server that has a requirement to authenticate its clients.

Hence, an iSF client can also be a server. It is a client only with respect to the Artix Security Service.

---

**iSF client SDK**

The *iSF client SDK* is the programming interface that enables the iSF clients to communicate (usually remotely) with the Artix Security Service.

**Note:** The iSF client SDK is only used internally. It is currently not available as a public programming interface.

---

**Artix Security Service**

The Artix Security Service is a standalone process that acts a thin wrapper layer around the iSF server module. On its own, the iSF server module is a Java library which could be accessed only through local calls. By embedding the iSF server module within the Artix Security Service, however, it becomes possible to access the security service remotely.

---

**iSF server module**

The *iSF server module* is a broker that mediates between iSF clients, which request the security service to perform security operations, and a third-party security service, which is the ultimate repository for security data.

The *iSF server module* has the following special features:

- A replaceable iSF adapter component that enables integration with a third-party enterprise security service.
  - A single sign-on feature with user session caching.
- 

**iSF adapter SDK**

The *iSF adapter SDK* is the Java API that enables a developer to create a custom iSF adapter that plugs into the iSF server module.

---

**iSF adapter**

An *iSF adapter* is a replaceable component of the iSF server module that enables you to integrate with any third-party enterprise security service. An iSF adapter implementation provides access to a repository of authentication data and (optionally) authorization data as well.

---

**Example adapters**

The following standard adapters are provided with Artix:

- Lightweight Directory Access Protocol (LDAP).
- File—a simple adapter implementation that stores authentication and authorization data in a flat file.



**WARNING:** The file adapter is intended for demonstration purposes only. It is not industrial strength and is *not* meant to be used in a production environment.

# iSF Server Module Deployment Options

## Overview

The iSF server module, which is fundamentally implemented as a Java library, can be deployed in one of the following ways:

- [CORBA service](#).
- [Java library](#).

## CORBA service

The iSF server module can be deployed as a CORBA service (Artix Security Service), as shown in [Figure 42](#). This is the default deployment model for the iSF server module in Artix. This deployment option has the advantage that any number of distributed iSF clients can communicate with the iSF server module over IIOP/TLS.

With this type of deployment, the iSF server module is packaged as an application plug-in to the Orbix *generic server*. The Artix Security Service can be launched by the `itsecurity` executable and basic configuration is set in the `iona_services.security` scope of the Artix configuration file.

**Figure 42:** *iSF Server Module Deployed as a CORBA Service*

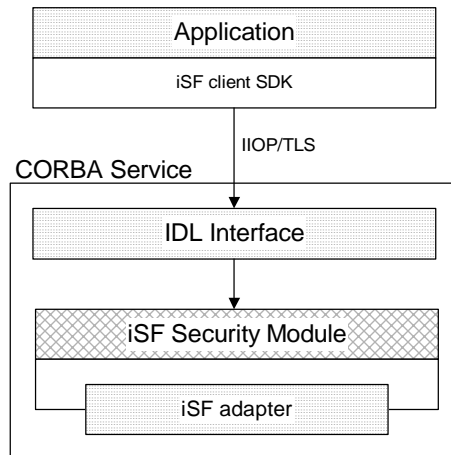

**Java library**

The iSF server module can be deployed as a Java library, as shown in [Figure 43](#), which permits access to the iSF server module from a single iSF client only.

With this type of deployment, the iSF security JAR file is loaded directly into a Java application. The security service is then instantiated as a local object and all calls made through the iSF client SDK are local calls.

**Figure 43:** *iSF Server Module Deployed as a Java Library*

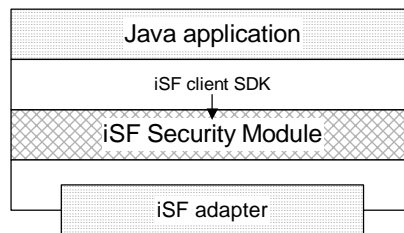

---

# iSF Adapter Overview

---

## Overview

This section provides an overview of the iSF adapter architecture. The modularity of the iSF server module design makes it relatively straightforward to implement a custom iSF adapter written in Java.

---

## Standard iSF adapters

IONA provides several ready-made adapters that are implemented with the iSF adapter API. The following standard adapters are currently available:

- File adapter.
- LDAP adapter.

---

## Custom iSF adapters

The iSF server module architecture also allows you to implement your own custom iSF adapter and use it instead of a standard adapter.

---

## Main elements of a custom iSF adapter

The main elements of a custom iSF adapter are, as follows:

- [Implementation of the ISF Adapter Java interface.](#)
- [Configuration of the iSF adapter using the iSF properties file.](#)

---

## Implementation of the ISF Adapter Java interface

The only code that needs to be written to implement an iSF adapter is a class to implement the `IS2Adapter` Java interface. The adapter implementation class should respond to authentication requests either by checking a repository of user data or by forwarding the requests to a third-party enterprise security service.

---

## Configuration of the iSF adapter using the iSF properties file

The iSF adapter is configured by setting Java properties in the `is2.properties` file. The `is2.properties` file stores two kinds of configuration data for the iSF adapter:

- Configuration of the iSF server module to load the adapter—see [“Configuring iSF to Load the Adapter” on page 394.](#)
- Configuration of the adapter itself—see [“Setting the Adapter Properties” on page 395.](#)

---

# Implementing the IS2Adapter Interface

---

## Overview

The `com.iona.security.is2adapter` package defines an `IS2Adapter` Java interface, which a developer must implement to create a custom iSF adapter. The methods defined on the `ISFAdapter` class are called by the iSF server module in response to requests received from iSF clients.

This section describes a simple example implementation of the `IS2Adapter` interface, which is capable of authenticating a single test user with hard-coded authorization properties.

---

## Test user

The example adapter implementation described here permits authentication of just a single user, `test_user`. The test user has the following authentication data:

```
Username: test_user  
Password: test_password
```

and the following authorization data:

- The user's global realm contains the `GuestRole` role.
  - The user's `EngRealm` realm contains the `EngineerRole` role.
  - The user's `FinanceRealm` realm contains the `AccountantRole` role.
- 

## iSF adapter example

[Example 75](#) shows a sample implementation of an iSF adapter class, `ExampleAdapter`, that permits authentication of a single user. The user's username, password, and authorization are hard-coded. In a realistic system, however, the user data would probably be retrieved from a database or from a third-party enterprise security system.

### Example 75: Sample ISF Adapter Implementation

```
import com.iona.security.azmgr.AuthorizationManager;  
import com.iona.security.common.AuthenticatedPrincipal;  
import com.iona.security.common.Realm;  
import com.iona.security.common.Role;  
import com.iona.security.is2adapter.IS2Adapter;  
import com.iona.security.is2adapter.IS2AdapterException;  
import java.util.Properties;  
import java.util.ArrayList;  
import java.security.cert.X509Certificate;
```

**Example 75:** *Sample ISF Adapter Implementation*

```

import org.apache.log4j.*;
import java.util.ResourceBundle;

import java.util.MissingResourceException;

public class ExampleAdapter implements IS2Adapter {

    public final static String EXAMPLE_PROPERTY =
        "example_property";

    public final static String ADAPTER_NAME = "ExampleAdapter";

1 private final static String MSG_EXAMPLE_ADAPTER_INITIALIZED
    = "initialized";
private final static String MSG_EXAMPLE_ADAPTER_CLOSED
    = "closed";
private final static String MSG_EXAMPLE_ADAPTER_AUTHENTICATE
    = "authenticate";
    private final static String
MSG_EXAMPLE_ADAPTER_AUTHENTICATE_REALM =
    "authenticate_realm";
    private final static String
MSG_EXAMPLE_ADAPTER_AUTHENTICATE_OK = "authenticateok";
private final static String MSG_EXAMPLE_ADAPTER_GETAUTHINFO
    = "getauthinfo";
    private final static String
MSG_EXAMPLE_ADAPTER_GETAUTHINFO_OK = "getauthinfook";

    private ResourceBundle _res_bundle = null;

2 private static Logger LOG =
    Logger.getLogger(ExampleAdapter.class.getName());

    public ExampleAdapter() {
3 _res_bundle = ResourceBundle.getBundle("ExampleAdapter");
    LOG.setResourceBundle(_res_bundle);
    }

4 public void initialize(Properties props)
    throws IS2AdapterException {

        LOG.l7dlog(Priority.INFO, ADAPTER_NAME + "." +
MSG_EXAMPLE_ADAPTER_INITIALIZED,null);

```

**Example 75:** *Sample ISF Adapter Implementation*

```

// example property
String propVal = props.getProperty(EXAMPLE_PROPERTY);
LOG.info(propVal);

}

5 public void close() throws IS2AdapterException {
    LOG.l7dlog(Priority.INFO, ADAPTER_NAME + "." +
MSG_EXAMPLE_ADAPTER_CLOSED, null);
}

6 public AuthenticatedPrincipal authenticate(String username,
String password)
throws IS2AdapterException {

7     LOG.l7dlog(Priority.INFO, ADAPTER_NAME + "." +
MSG_EXAMPLE_ADAPTER_AUTHENTICATE,new
Object[]{username,password},null);

    AuthenticatedPrincipal ap = null;
    try{
        if (username.equals("test_user")
            && password.equals("test_password")){
8                ap = getAuthorizationInfo(new
AuthenticatedPrincipal(username));
        }
        else {
            LOG.l7dlog(Priority.WARN, ADAPTER_NAME + "." +
IS2AdapterException.WRONG_NAME_PASSWORD,null);
9                throw new IS2AdapterException(_res_bundle,this,
IS2AdapterException.WRONG_NAME_PASSWORD, new
Object[]{username});
        }

    } catch (Exception e) {
        LOG.l7dlog(Priority.WARN, ADAPTER_NAME + "." +
IS2AdapterException.AUTH_FAILED,e);
        throw new IS2AdapterException(_res_bundle,this,
IS2AdapterException.AUTH_FAILED, new Object[]{username}, e);
    }

    LOG.l7dlog(Priority.WARN, ADAPTER_NAME + "." +
MSG_EXAMPLE_ADAPTER_AUTHENTICATE_OK,null);
    return ap;
}

```

**Example 75: Sample ISF Adapter Implementation**

```

    }
10    public AuthenticatedPrincipal authenticate(String realmname,
String username, String password)
throws IS2AdapterException {

        LOG.l7dlog(Priority.INFO, ADAPTER_NAME + "." +
MSG_EXAMPLE_ADAPTER_AUTHENTICATE_REALM,new
Object []{realmname,username,password},null);

        AuthenticatedPrincipal ap = null;
        try{
            if (username.equals("test_user")
11                && password.equals("test_password")){
                AuthenticatedPrincipal principal = new
AuthenticatedPrincipal(username);
                principal.setCurrentRealm(realmname);
                ap = getAuthorizationInfo(principal);
            }
            else {
                LOG.l7dlog(Priority.WARN, ADAPTER_NAME + "." +
IS2AdapterException.WRONG_NAME_PASSWORD,null);
                throw new IS2AdapterException(_res_bundle, this,
IS2AdapterException.WRONG_NAME_PASSWORD, new
Object []{username});
            }

            } catch (Exception e) {
                LOG.l7dlog(Priority.WARN, ADAPTER_NAME + "." +
IS2AdapterException.AUTH_FAILED,e);
                throw new IS2AdapterException(_res_bundle, this,
IS2AdapterException.AUTH_FAILED, new Object []{username}, e);
            }

            LOG.l7dlog(Priority.WARN, ADAPTER_NAME + "." +
MSG_EXAMPLE_ADAPTER_AUTHENTICATE_OK,null);
            return ap;
        }

12    public AuthenticatedPrincipal authenticate(X509Certificate
certificate)
throws IS2AdapterException {
        throw new IS2AdapterException(
            _res_bundle, this,
            IS2AdapterException.NOT_IMPLEMENTED

```



**Example 75: Sample ISF Adapter Implementation**

```

    );
}

13 public AuthenticatedPrincipal authenticate(String realm,
X509Certificate certificate)
throws IS2AdapterException {
    throw new IS2AdapterException(
        _res_bundle, this,
14 IS2AdapterException.NOT_IMPLEMENTED
    );
}

14 public AuthenticatedPrincipal
getAuthorizationInfo(AuthenticatedPrincipal principal) throws
IS2AdapterException{

    LOG.l7dlog(Priority.INFO, ADAPTER_NAME + "." +
MSG_EXAMPLE_ADAPTER_GETAUTHINFO,new
Object [] {principal.getUserID()},null);

    AuthenticatedPrincipal ap = null;
    String username = principal.getUserID();
    String realmname = principal.getCurrentRealm();

    try{
15         if (username.equals("test_user")) {
16             ap = new AuthenticatedPrincipal(username);
17             ap.addRole(new Role("GuestRole", ""));

17             if (realmname == null || (realmname != null &&
realmname.equals("EngRealm")))
                {
                    ap.addRealm(new Realm("EngRealm", ""));
                    ap.addRole("EngRealm", new
Role("EngineerRole", ""));
18             }
                if (realmname == null || (realmname != null &&
realmname.equals("FinanceRealm")))
                    {
                        ap.addRealm(new Realm("FinanceRealm",""));
                        ap.addRole("FinanceRealm", new
Role("AccountantRole", ""));
                    }
                }
    }
}

```

**Example 75: Sample ISF Adapter Implementation**

```

        else {
            LOG.l7dlog(Priority.WARN, ADAPTER_NAME + "." +
                IS2AdapterException.USER_NOT_EXIST, new Object[]{username},
                null);
            throw new IS2AdapterException(_res_bundle, this,
                IS2AdapterException.USER_NOT_EXIST, new Object[]{username});
        }

        } catch (Exception e) {
            LOG.l7dlog(Priority.WARN, ADAPTER_NAME + "." +
                IS2AdapterException.AUTH_FAILED, e);
            throw new IS2AdapterException(_res_bundle, this,
                IS2AdapterException.AUTH_FAILED, new Object[]{username}, e);
        }

        LOG.l7dlog(Priority.WARN, ADAPTER_NAME + "." +
            MSG_EXAMPLE_ADAPTER_GETAUTHINFO_OK, null);
        return ap;
    }

19     public AuthenticatedPrincipal getAuthorizationInfo(String
        username) throws IS2AdapterException{

            // this method has been deprecated
            throw new IS2AdapterException(
                _res_bundle, this,
                IS2AdapterException.NOT_IMPLEMENTED
            );
        }

20     public AuthenticatedPrincipal getAuthorizationInfo(String
        realmname, String username) throws IS2AdapterException{

            // this method has been deprecated
            throw new IS2AdapterException(
                _res_bundle, this,
                IS2AdapterException.NOT_IMPLEMENTED
            );
        }

21     public ArrayList getAllUsers()
        throws IS2AdapterException {

```

**Example 75:** *Sample ISF Adapter Implementation*

```

        throw new IS2AdapterException(
            _res_bundle, this,
            IS2AdapterException.NOT_IMPLEMENTED
        );

    }

    public void logout (AuthenticatedPrincipal ap) throws
    IS2AdapterException {

    }

}

```

The preceding iSF adapter code can be explained as follows:

1. These lines list the keys to the messages from the adapter's resource bundle. The resource bundle stores messages used by the Log4J logger and exceptions thrown in the adapter.
2. This line creates a Log4J logger.
3. This line loads the resource bundle for the adapter.
4. The `initialize()` method is called just after the adapter is loaded. The properties passed to the `initialize()` method, `props`, are the adapter properties that the iSF server module has read from the `is2.properties` file. See ["Setting the Adapter Properties" on page 395](#) for more details.
5. The `close()` method is called to shut down the adapter. This gives you an opportunity to clean up and free resources used by the adapter.
6. This variant of the `IS2Adapter.authenticate()` method is called whenever an iSF client calls `AuthManager.authenticate()` with username and password parameters. In this simple demonstration implementation, the `authenticate()` method recognizes only one user, `test_user`, with password, `test_password`.
7. This line calls a Log4J method in order to log a localized and parametrized message to indicate that the `authenticate` method has been called with the specified username and password values. Since

all the keys in the resource bundle begin with the adapter name, the adapter name is prepended to the key. The `l7dlog()` method is used because it automatically searches the resource bundle which was set previously by the loggers `setResourceBundle()` method.

8. If authentication is successful; that is, if the name and password passed in match `test_user` and `test_password`, the `getAuthorizationInfo()` method is called to obtain an `AuthenticatedPrincipal` object populated with *all* of the user's realms and role
9. If authentication fails, an `IS2AdapterException` is raised with minor code `IS2AdapterException.WRONG_NAME_PASSWORD`. The resource bundle is passed to the exception as it accesses the exception message from the bundle using the key, `ExampleAdapter.wrongUsernamePassword`.
10. This variant of the `IS2Adapter.authenticate()` method is called whenever an iSF client calls `AuthManager.authenticate()` with realm name, username and password parameters.  
This method differs from the preceding username/password `authenticate()` method in that only the authorization data for the specified realm and the global realm are included in the return value.
11. If authentication is successful, the `getAuthorizationInfo()` method is called to obtain an `AuthenticatedPrincipal` object populated with the authorization data from the specified realm and the global realm.
12. This variant of the `IS2Adapter.authenticate()` method is called whenever an iSF client calls `AuthManager.authenticate()` with an X.509 certificate parameter.
13. This variant of the `IS2Adapter.authenticate()` method is called whenever an iSF client calls `AuthManager.authenticate()` with a realm name and an X.509 certificate parameter.  
This method differs from the preceding certificate `authenticate()` method in that only the authorization data for the specified realm and the global realm are included in the return value.
14. This method should create an `AuthenticatedPrincipal` object for the username user. If a realm is *not* specified in the principal, the `AuthenticatedPrincipal` is populated with all realms and roles for this

- user. If a realm *is* specified in the principal, the `AuthenticatedPrincipal` is populated with authorization data from the specified realm and the global realm only.
15. This line creates a new `AuthenticatedPrincipal` object for the username `user` to hold the user's authorization data.
  16. This line adds a `GuestRole` role to the global realm, `IONAGlobalRealm`, using the single-argument form of `addRole()`. Roles added to the global realm implicitly belong to every named realm as well.
  17. This line checks if no realm is specified in the principal or if the realm, `EngRealm`, is specified. If either of these is true, the following lines add the authorization realm, `EngRealm`, to the `AuthenticatedPrincipal` object and add the `EngineerRole` role to the `EngRealm` authorization realm.
  18. This line checks if no realm is specified in the principal or if the realm, `FinanceRealm`, is specified. If either of these is true, the following lines add the authorization realm, `FinanceRealm`, to the `AuthenticatedPrincipal` object and add the `AccountantRole` role to the `FinanceRealm` authorization realm.
  19. Since SSO was introduced to Artix, this variant of the `IS2Adapter.getAuthorizationInfo()` method has been deprecated. The method `IS2Adapter.getAuthorizationInfo(AuthenticatedPrincipal principal)` should be used instead.
  20. Since SSO was introduced to Artix, this variant of the `IS2Adapter.getAuthorizationInfo()` method has also been deprecated. The method `IS2Adapter.getAuthorizationInfo(AuthenticatedPrincipal principal)` should be used instead.
  21. The `getAllUsers()` method is currently not used by the iSF server module during runtime. Hence, there is no need to implement this method currently.

22. When the `logout()` method is called, you can perform cleanup and release any resources associated with the specified user principal. The iSF server module calls back on `IS2Adapter.logout()` either in response to a user calling `AuthManager.logout()` explicitly or after an SSO session has timed out.

---

# Deploying the Adapter

---

**Overview**

This section explains how to deploy a custom iSF adapter.

---

**In this section**

This section contains the following subsections:

<a href="#">Configuring iSF to Load the Adapter</a>	<a href="#">page 394</a>
<a href="#">Setting the Adapter Properties</a>	<a href="#">page 395</a>
<a href="#">Loading the Adapter Class and Associated Resource Files</a>	<a href="#">page 396</a>

---

## Configuring iSF to Load the Adapter

---

### Overview

You can configure the iSF server module to load a custom adapter by setting the following properties in the iSF server module's `is2.properties` file:

- [Adapter name](#).
- [Adapter class](#).

---

### Adapter name

The iSF server module loads the adapter identified by the `com.iona.isp.adapters` property. Hence, to load a custom adapter, `AdapterName`, set the property as follows:

```
com.iona.isp.adapters=AdapterName
```

**Note:** In the current implementation, the iSF server module can load only a single adapter at a time.

---

### Adapter class

The name of the adapter class to be loaded is specified by the following property setting:

```
com.iona.isp.adapter.AdapterName.class=AdapterClass
```

---

### Example adapter

For example, the example adapter provided shown previously can be configured to load by setting the following properties:

```
com.iona.isp.adapters=example  
com.iona.isp.adapter.example.class=isfadapter.ExampleAdapter
```



---

## Setting the Adapter Properties

---

### Overview

This subsection explains how you can set properties for a specific custom adapter in the `is2.properties` file.

---

### Adapter property name format

All configurable properties for a custom file adapter, `AdapterName`, should have the following format:

```
com.iona.isp.adapter.AdapterName.param.PropertyName
```

---

### Truncation of property names

Adapter property names are truncated before being passed to the iSF adapter. That is, the `com.iona.ispadapter.AdapterName.param` prefix is stripped from each property name.

---

### Example

For example, given an adapter named `ExampleAdapter` which has two properties, `host` and `port`, these properties would be set as follows in the `is2.properties` file:

```
com.iona.isp.adapter.example.param.example_property="This is an  
example property"
```

Before these properties are passed to the iSF adapter, the property names are truncated as if they had been set as follows:

```
example_property="This is an example property"
```

---

### Accessing properties from within an iSF adapter

The adapter properties are passed to the iSF adapter through the `com.iona.security.is2adapter.IS2Adapter.initialize()` callback method. For example:

```
...  
public void initialize(java.util.Properties props)  
throws IS2AdapterException {  
    // Access a property through its truncated name.  
    String propVal = props.getProperty("PropertyName")  
    ...  
}
```

---

## Loading the Adapter Class and Associated Resource Files

---

### Overview

You need to make appropriate modifications to your `CLASSPATH` to ensure that the iSF server module can find your custom adapter class. You need to distinguish between the following usages of the iSF server module:

- [CORBA service](#).
- [Java library](#)

In all cases, the location of the file used to configure Log4j logging can be set using the `log4j.configuration` property in the `is2.properties` file.

---

### CORBA service

By default, the Artix Security Service uses the `secure_artix.full_security.security_service` scope in your Orbix configuration file (or configuration repository service). Modify the `plugins:java_server:classpath` variable to include the directory containing the compiled adapter class and the adapter's resource bundle. The `plugins:java_server:classpath` variable uses the value of the `SECURITY_CLASSPATH` variable.

For example, if the adapter class and adapter resource bundle are located in the `ArtixInstallDir\ExampleAdapter` directory, you should set the `SECURITY_CLASSPATH` variable as follows:

```
# Artix configuration file
SECURITY_CLASSPATH =
  "ArtixInstallDir\ExampleAdapter;ArtixInstallDir\lib\corba\security_service\5.1\security_service-rt.jar";
```

### Java library

In this case, to make the custom iSF adapter class available to an iSF client, add the directory containing the compiled adapter class and adapter resource bundle to your `CLASSPATH`.

You must also specify the location of the license file, which can be set in one of the following ways:

- Uncomment and set the value of the `is2.license.filename` property in your domain's `is2.properties` file to point to license file for product. For example:

```
# iSF properties file
is2.license.filename=ArtixInstallDir/licenses.txt
```

- Add the license file to the `CLASSPATH` used for the iSF client.
- Pass the license file location to the iSF client using a Java system property:

```
java -DIT_LICENSE_FILE=LocationOfLicenseFile iSFClientClass
```

- Set the license in the code for the iSF client. For example:

```
// Java
...
SecurityService service = SecurityService.instance();
Properties props = new Properties();
props.load(new FileInputStream(propsFileName));
props.setProperty(
    SecurityService.IS2_LICENSE_FILE_NAME,
    LocationOfLicenseFile
);
service.initializeSecurity(props);
```



# Artix Security

*This appendix describes variables used by the IONA Security Framework. The Artix security infrastructure is highly configurable.*

---

**In this appendix**

This appendix discusses the following topics:

<a href="#">Applying Constraints to Certificates</a>	page 401
<a href="#">bus:initial_contract</a>	page 403
<a href="#">bus:security</a>	page 404
<a href="#">initial_references</a>	page 406
<a href="#">password_retrieval_mechanism</a>	page 408
<a href="#">plugins:asp</a>	page 409
<a href="#">plugins:at_http</a>	page 412
<a href="#">plugins:atli2_tls</a>	page 417
<a href="#">plugins:csi</a>	page 418
<a href="#">plugins:csi</a>	page 418
<a href="#">plugins:gsp</a>	page 419
<a href="#">plugins:http</a>	page 423
<a href="#">plugins:iiop_tls</a>	page 428

<a href="#">plugins:java_server</a>	<a href="#">page 432</a>
<a href="#">plugins:kdm</a>	<a href="#">page 435</a>
<a href="#">plugins:kdm_adm</a>	<a href="#">page 437</a>
<a href="#">plugins:login_client</a>	<a href="#">page 438</a>
<a href="#">plugins:login_service</a>	<a href="#">page 439</a>
<a href="#">plugins:schannel</a>	<a href="#">page 440</a>
<a href="#">plugins:security</a>	<a href="#">page 441</a>
<a href="#">plugins:wSDL_publish</a>	<a href="#">page 444</a>
<a href="#">policies</a>	<a href="#">page 445</a>
<a href="#">policies:asp</a>	<a href="#">page 452</a>
<a href="#">policies:bindings</a>	<a href="#">page 455</a>
<a href="#">policies:csi</a>	<a href="#">page 457</a>
<a href="#">policies:external_token_issuer</a>	<a href="#">page 460</a>
<a href="#">policies:https</a>	<a href="#">page 461</a>
<a href="#">policies:iioptls</a>	<a href="#">page 464</a>
<a href="#">policies:security_server</a>	<a href="#">page 474</a>
<a href="#">principal_sponsor</a>	<a href="#">page 476</a>
<a href="#">principal_sponsor:csi</a>	<a href="#">page 480</a>
<a href="#">principal_sponsor:https</a>	<a href="#">page 483</a>

---

# Applying Constraints to Certificates

---

## Certificate constraints policy

You can use the `CertConstraintsPolicy` to apply constraints to peer X.509 certificates by the default `CertificateValidatorPolicy`. These conditions are applied to the owner's distinguished name (DN) on the first certificate (peer certificate) of the received certificate chain. Distinguished names are made up of a number of distinct fields, the most common being Organization Unit (OU) and Common Name (CN).

---

## Configuration variable

You can specify a list of constraints to be used by `CertConstraintsPolicy` through the `policies:iiop_tls:certificate_constraints_policy` or `policies:certificate_constraints_policy` configuration variables. For example:

```
policies:iiop_tls:certificate_constraints_policy =
    ["CN=Johnny*,OU=[unit1|IT_SSL],O=IONA,C=Ireland,ST=Dublin,L=Earth",
     "CN=Paul*,OU=SSLTEAM,O=IONA,C=Ireland,ST=Dublin,L=Earth",
     "CN=TheOmnipotentOne"];
```

---

## Constraint language

These are the special characters and their meanings in the constraint list:

*	Matches any text. For example: an* matches ant and anger, but not aunt
[ ]	Grouping symbols.
	Choice symbol. For example: OU=[unit1 IT_SSL] signifies that if the OU is unit1 or IT_SSL, the certificate is acceptable.
=, !=	Signify equality and inequality respectively.

---

## Example

This is an example list of constraints:

```
policies:iiop_tls:certificate_constraints_policy = [
    "OU=[unit1|IT_SSL],CN=Steve*,L=Dublin",
    "OU=IT_ART*,OU!=IT_ARTtesters,CN=[Jan|Donal],ST=
    Boston" ];
```

This constraint list specifies that a certificate is deemed acceptable if and only if it satisfies one or more of the constraint patterns:

```

If
  The OU is unit1 or IT_SSL
  And
  The CN begins with the text Steve
  And
  The location is Dublin
Then the certificate is acceptable
Else (moving on to the second constraint)
If
  The OU begins with the text IT_ART but isn't IT_ARTtesters
  And
  The common name is either Donal or Jan
  And
  The State is Boston
Then the certificate is acceptable
Otherwise the certificate is unacceptable.

```

The language is like a boolean OR, trying the constraints defined in each line until the certificate satisfies one of the constraints. Only if the certificate fails all constraints is the certificate deemed invalid.

Note that this setting can be sensitive about white space used within it. For example, "CN =" might not be recognized, where "CN=" is recognized.

## Distinguished names

For more information on distinguished names, see the *Security Guide*.



---

# bus:initial\_contract

The `bus:initial_contract` namespace contains the following configuration variable:

- [url:isf\\_service](#)

---

## url:isf\_service

Specifies the location of the Artix security service's WSDL contract. This variable is needed by applications that connect to the Artix security service through a protocol specified in the physical part of the security service's WSDL contract (the alternative would be to connect over IIOP/TLS using a CORBA object reference).

This variable is used in conjunction with the `policies:asp:use_artix_proxies` configuration variable.

---

## bus:security

The variables in the `bus:security` are intended for use with the `it_container_admin` utility, in order to facilitate communication with a secure Artix container. The `bus:security` namespace contains the following configuration variables:

- `enable_security`
- `user_name`
- `user_password`

---

### enable\_security

The `bus:security:enable_security` variable is a boolean variable that enables a client to send WSSE username and password credentials. When `true`, the client sends WSSE username and password credentials with every SOAP request message (whether or not the connection is secured by SSL/TLS); when `false`, the feature is disabled.

There are essentially two different ways of initializing the WSSE username and password credentials on the client side:

- *From the configuration file*—you can set the WSSE credentials in the Artix configuration using the related `user_name` and `user_password` configuration variables. For example:

```
# Artix Configuration File
bus:security:enable_security = "true";
bus:security:user_name = "Username";
bus:security:user_password = "Password";
```

- *From the command line*—if you omit the `bus:security:user_name` and `bus:security:user_password` settings from the Artix configuration, the client program will prompt you for the username and password credentials as it starts up. For example:

```
Please enter login :
Please enter password :
```

---

**user\_name**

Initializes a WSSE username. This variable is intended for use in conjunction with the `bus:security:enable_security` variable as part of the configuration for the `it_container_admin` utility.

---

**user\_password**

Initializes a WSSE password. This variable is intended for use in conjunction with the `bus:security:enable_security` variable as part of the configuration for the `it_container_admin` utility.

---

## initial\_references

The `initial_references` namespace contains the following configuration variables:

- [IT\\_SecurityService:reference](#)
  - [IT\\_TLS\\_Toolkit:plugin](#)
- 

### IT\_SecurityService:reference

This configuration variable specifies the location of the Artix security service. Clients of the security service need this configuration setting in order to locate and connect to the security service through the IIOP/TLS protocol.

**Note:** This variable is *not* relevant to clients that connect to a HTTPS-based security service.

The most convenient way to initialize this variable is to use a `corbaloc` URL. The `corbaloc` URL typically has the following format:

```
corbaloc:it_iops:1.2@Hostname:Port/IT_SecurityService
```

Where *Hostname* is the name of the host where the security service is running and *Port* is the IP port where the security service is listening for incoming connections.

If the security service is configured as a cluster, you need to use a multi-profile `corbaloc` URL, which lists the addresses of all the services in the cluster. For example, if you configure a cluster of three services—with addresses `security01:5001`, `security02:5002`, and `security03:5003`—you would set the `corbaloc` URL as follows:

```
corbaloc:it_iops:1.2@security01:5001,it_iops:1.2@security02:5002,it_iops:1.2@security03:5003/IT_SecurityService
```

---

## IT\_TLS\_Toolkit:plugin

This configuration variable enables you to specify the underlying SSL/TLS toolkit to be used by Artix. It is used in conjunction with the `plugins:baltimore_toolkit:shlib_name`, `plugins:schannel_toolkit:shlib_name` (Windows only) and `plugins:systemssl_toolkit:shlib_name` (z/OS only) configuration variables to implement SSL/TLS toolkit replaceability.

The default is the Baltimore toolkit.

For example, to specify that an application should use the Schannel SSL/TLS toolkit, you would set configuration variables as follows:

```
initial_references:IT_TLS_Toolkit:plugin = "schannel_toolkit";  
plugins:schannel_toolkit:shlib_name = "it_tls_schannel";
```

---

## password\_retrieval\_mechanism

The configuration variables in the `password_retrieval_mechanism` namespace are intended to be used *only* by the Artix services. The following variables are defined in this namespace:

- [inherit\\_from\\_parent](#)
- [use\\_my\\_password\\_as\\_kdm\\_password](#)

---

### inherit\_from\_parent

If an application forks a child process and this variable is set to `true`, the child process inherits the parent's X.509 certificate password through the environment.

**Note:** This variable is intended for use *only* by the standard Artix services.

---

### use\_my\_password\_as\_kdm\_password

This variable should be set to `true` only in the scope of the KDM plug-in's container. From a security perspective it is dangerous to do otherwise as the password could be left in cleartext within the process.

The KDM is a locator plug-in and so it is natural that it should use the locator's identity as its identity. However, it requires a password to encrypt its security information. By default the KDM requests such a password from the user during locator startup and this is separate from the locator password. The locator password would be used if this variable is set to `true`.

**Note:** This variable is intended for use *only* by the standard Artix services.

---

# plugins:asp

The `plugins:asp` namespace contains the following variables:

- `authentication_cache_size`
- `authentication_cache_timeout`
- `authorization_realm`
- `default_password`
- `enable_security_service_cert_authentication`
- `enable_security_service_load_balancing`
- `security_type`
- `security_level`

---

## authentication\_cache\_size

The maximum number of credentials stored in the authentication cache. If this size is exceeded, any new authentication tokens acquired by calling the Artix security service are *not* stored in the cache. The cache can shrink again if some of the cached credentials expire (either because the individual token expiry time is exceeded or the

`plugins:asp:authentication_cache_timeout` is exceeded).

A value of -1 (the default) means unlimited size. A value of 0 means disable the cache. The value must lie within the range -1 to  $2^{31}-1$ .

**Note:** This variable does not affect CORBA credentials. For details of how to configure the CORBA cache, see “[plugins:gsp](#)” on page 419.

## authentication\_cache\_timeout

The time (in seconds) after which a credential expires. Expired credentials are removed from the cache and must re-authenticate with the Artix security service on the next call from that user.

A value of -1 means an infinite time-out. A value of 0 means disable the cache. The value must lie within the range -1 to  $2^{31}-1$ .

Default is 500 seconds.

**Note:** This variable does not affect CORBA credentials. For details of how to configure the CORBA cache, see [“plugins:gsp” on page 419](#).

---

## authorization\_realm

Specifies the Artix authorization realm to which an Artix server belongs. The value of this variable determines which of a user’s roles are considered when making an access control decision.

For example, consider a user that belongs to the `ejb-developer` and `corba-developer` roles within the `Engineering` realm, and to the `ordinary` role within the `Sales` realm. If you set `plugins:asp:authorization_realm` to `Sales` for a particular server, only the `ordinary` role is considered when making access control decisions (using the action-role mapping file).

The default is `IONAGlobalRealm`.

---

## default\_password

When the client credentials originate either from a CORBA Principal (embedded in a SOAP header) or from a certificate subject, the `default_password` variable specifies the password to use on the server side. The `plugins:asp:default_password` variable is used to get around the limitation that a `PRINCIPAL` identity and a `CERT_SUBJECT` are propagated without an accompanying password.

The `artix_security` plug-in uses the received client principal together with the password specified by `plugins:asp:default_password` to authenticate the user through the Artix security service.



The default value is the string, `default_password`.

---

## **enable\_security\_service\_cert\_authentication**

When this parameter is set to `true`, the client certificate is retrieved from the TLS connection. If no other credentials are available, the client certificate is then sent to the Artix security service for authentication.

The client certificate has the lowest precedence for authentication. Hence, if any other credentials are presented by the client (for example, if the client sends a WSSE username and password), these alternative credentials are sent to the Artix security service instead of the certificate credentials.

Default is `false`.

---

## **enable\_security\_service\_load\_balancing**

A boolean variable that enables load balancing over a cluster of security services. If an application is deployed in a domain that uses security service clustering, the application should be configured to use *client load balancing* (in this context, *client* means a client of the Artix security service). See also `policies:iiop_tls:load_balancing_mechanism`.

Default is `false`.

---

## **security\_type**

*(Obsolete)* From Artix 3.0 onwards, this variable is ignored.

---

## **security\_level**

Specifies the level from which security credentials are picked up. The following options are supported by the `artix_security` plug-in:

- |                            |                                                                          |
|----------------------------|--------------------------------------------------------------------------|
| <code>MESSAGE_LEVEL</code> | Get security information from the transport header. This is the default. |
| <code>REQUEST_LEVEL</code> | Get the security information from the message header.                    |

---

## plugins:at\_http

The `plugins:at_http` configuration variables are provided to facilitate migration from legacy Artix applications (that is, Artix releases prior to version 3.0). The `plugins:at_http` namespace contains variables that are similar to the variables from the old (pre-version 3.0) `plugins:http` namespace. One important change made in 3.0, however, is that an application's own certificate must now be provided in PKCS#12 format (where they were previously supplied in PEM format).

If the variables from the `plugins:at_http` namespace are used, they take precedence over the analogous variables from the `principal_sponsor:https` and `policies:https` namespaces.

The `plugins:at_http` namespace contains the following variables:

- `client:client_certificate`.
- `client:client_private_key_password`.
- `client:trusted_root_certificates`.
- `client:use_secure_sockets`.
- `server:server_certificate`.
- `server:server_private_key_password`.
- `server:trusted_root_certificates`.
- `server:use_secure_sockets`.

---

### client:client\_certificate

This variable specifies the full path to the PKCS#12-encoded X.509 certificate issued by the certificate authority for the client. For example:

```
plugins:at_http:client:client_certificate =  
    "C:\aspens\509\certs\key.cert.p12"
```

---

### client:client\_private\_key\_password

This variable specifies the password to decrypt the contents of the PKCS#12 certificate file specified by `client:client_certificate`.

---

## client:trusted\_root\_certificates

This variable specifies the path to a file containing a concatenated list of CA certificates in PEM format. The client uses this CA list during the TLS handshake to verify that the server's certificate has been signed by a trusted CA.

---

## client:use\_secure\_sockets

The effect of the `client:use_secure_sockets` variable depends on the type of URL specifying the remote service location:

- `https://host:port` URL format—the client always attempts to open a secure connection. That is, the value of `plugins:at_http:client:use_secure_sockets` is effectively ignored.
- `http://host:port` URL format—whether the client attempts to open a secure connection or not depends on the value of `plugins:at_http:client:use_secure_sockets`, as follows:
  - ◆ `true`—the client attempts to open a secure connection (that is, HTTPS running over SSL or TLS). If no port is specified in the `http` URL, the client uses port 443 for secure HTTPS.
  - ◆ `false`—the client attempts to open an insecure connection (that is, plain HTTP).

If `plugins:at_http:client:use_secure_sockets` is true and the client decides to open a secure connection, the `at_http` plug-in then automatically loads the `https` plug-in.

**Note:** If `plugins:at_http:client:use_secure_sockets` is true and the client decides to open a secure connection, Artix uses the following client secure invocation policies by default:

```

policies:client_secure_invocation_policy:requires =
["Confidentiality", "Integrity", "DetectReplay",
"DetectMisordering", "EstablishTrustInTarget"];

policies:client_secure_invocation_policy:supports =
["Confidentiality", "Integrity", "DetectReplay",
"DetectMisordering", "EstablishTrustInTarget",
"EstablishTrustInClient"];

```

You can optionally override these defaults by setting the client secure invocation policy explicitly in configuration.

---

## server:server\_certificate

This variable specifies the full path to the PKCS#12-encoded X.509 certificate issued by the certificate authority for the server. For example:

```

plugins:at_http:server:server_certificate =
  "c:\aspens\509\certs\key.cert.p12"

```

---

## server:server\_private\_key\_password

This variable specifies the password to decrypt the contents of the PKCS#12 certificate file specified by `server:server_certificate`.

---

## server:trusted\_root\_certificates

This variable specifies the path to a file containing a concatenated list of CA certificates in PEM format. The server uses this CA list during the TLS handshake to verify that the client's certificate has been signed by a trusted CA.

---

## server:use\_secure\_sockets

The effect of the `server:use_secure_sockets` variable depends on the type of URL advertising the service location:

- `https://host:port` URL format—the server accepts only secure connection attempts. That is, the value of `plugins:at_http:server:use_secure_sockets` is effectively ignored.
- `http://host:port` URL format—whether the server accepts secure connection attempts or not depends on the value of `plugins:at_http:server:use_secure_sockets`, as follows:
  - ◆ `true`—the server accepts secure connection attempts (that is, HTTPS running over SSL or TLS). If no port is specified in the `http` URL, the server uses port 443 for secure HTTPS.
  - ◆ `false`—the server accepts insecure connection attempts (that is, plain HTTP).

If `plugins:at_http:server:use_secure_sockets` is set and the server accepts a secure connection, the `at_http` plug-in then automatically loads the `https` plug-in.

**Note:** If `plugins:at_http:server:use_secure_sockets` is set and the server accepts a secure connection, Artix uses the following server secure invocation policies by default:

```
    policies:target_secure_invocation_policy:requires =
["Confidentiality", "Integrity", "DetectReplay",
"DetectMisordering", "EstablishTrustInClient"];

    policies:target_secure_invocation_policy:supports =
["Confidentiality", "Integrity", "DetectReplay",
"DetectMisordering", "EstablishTrustInTarget",
"EstablishTrustInClient"];
```

You can optionally override these defaults by setting the target secure invocation policy explicitly in configuration.

## **server:use\_secure\_sockets:container**

The effect of the `server:use_secure_sockets:container` variable is similar to the effect of the `server:use_secure_sockets` variable, except that only the `ContainerService` service is affected. Using this variable, it is possible to enable HTTPS security specifically for the `ContainerService` service without affecting the security settings of other services deployed in the container.

---

## plugins:atli2\_tls

The `plugins:atli2_tls` namespace contains the following variable:

- `use_jsse_tk`

---

### use\_jsse\_tk

(Java only) Specifies whether or not to use the JSSE/JCE architecture with the CORBA binding. If `true`, the CORBA binding uses the JSSE/JCE architecture to implement SSL/TLS security; if `false`, the CORBA binding uses the Baltimore SSL/TLS toolkit.

The default is `false`.

---

## plugins:csi

The `policies:csi` namespace includes variables that specify settings for Common Secure Interoperability version 2 (CSIv2):

- `ClassName`
- `shlib_name`

---

### ClassName

`ClassName` specifies the Java class that implements the `csi` plugin. The default setting is:

```
plugins:csi:ClassName = "com.iona.corba.security.csi.CSIPlugin";
```

This configuration setting makes it possible for the Artix core to load the plugin on demand. Internally, the Artix core uses a Java class loader to load and instantiate the `csi` class. Plugin loading can be initiated either by including the `csi` in the `orb_plugins` list, or by associating the plugin with an initial reference.

---

### shlib\_name

`shlib_name` identifies the shared library (or DLL in Windows) containing the `csi` plugin implementation.

```
plugins:csi:shlib_name = "it_csi_prot";
```

The `csi` plug-in becomes associated with the `it_csi_prot` shared library, where `it_csi_prot` is the base name of the library. The library base name, `it_csi_prot`, is expanded in a platform-dependent manner to obtain the full name of the library file.



---

## plugins:gsp

The `plugins:gsp` namespace includes variables that specify settings for the Generic Security Plugin (GSP). This provides authorization by checking a user's roles against the permissions stored in an action-role mapping file. It includes the following:

- `accept_asserted_authorization_info`
- `action_role_mapping_file`
- `assert_authorization_info`
- `authentication_cache_size`
- `authentication_cache_timeout`
- `authorization_realm`
- `ClassName`
- `enable_authorization`
- `enable_gssup_sso`
- `enable_user_id_logging`
- `enable_x509_sso`
- `enforce_secure_comms_to_sso_server`
- `enable_security_service_cert_authentication`
- `sso_server_certificate_constraints`
- `use_client_load_balancing`

---

### accept\_asserted\_authorization\_info

If `false`, SAML data is not read from incoming connections. Default is `true`.

---

### action\_role\_mapping\_file

Specifies the action-role mapping file URL. For example:

```
plugins:gsp:action_role_mapping_file =  
    "file:///my/action/role/mapping";
```

---

## assert\_authorization\_info

If `false`, SAML data is not sent on outgoing connections. Default is `true`.

---

## authentication\_cache\_size

The maximum number of credentials stored in the authentication cache. If this size is exceeded the oldest credential in the cache is removed.

A value of `-1` (the default) means unlimited size. A value of `0` means disable the cache.

---

## authentication\_cache\_timeout

The time (in seconds) after which a credential is considered *stale*. Stale credentials are removed from the cache and the server must re-authenticate with the Artix security service on the next call from that user. The cache timeout should be configured to be smaller than the timeout set in the `is2.properties` file (by default, that setting is `is2.sso.session.timeout=600`).

A value of `-1` (the default) means an infinite time-out. A value of `0` means disable the cache.

---

## authorization\_realm

`authorization_realm` specifies the iSF authorization realm to which a server belongs. The value of this variable determines which of a user's roles are considered when making an access control decision.

For example, consider a user that belongs to the `ejb-developer` and `corba-developer` roles within the `Engineering` realm, and to the `ordinary` role within the `Sales` realm. If you set `plugins:gsp:authorization_realm` to `Sales` for a particular server, only the `ordinary` role is considered when making access control decisions (using the `action-role` mapping file).

---

## ClassName

`ClassName` specifies the Java class that implements the `gsp` plugin. This configuration setting makes it possible for the Artix core to load the plugin on demand. Internally, the Artix core uses a Java class loader to load and instantiate the `gsp` class. Plugin loading can be initiated either by including the `csi` in the `orb_plugins` list, or by associating the plugin with an initial reference.

---

## enable\_authorization

A boolean GSP policy that, when `true`, enables authorization using action-role mapping ACLs in server.

Default is `true`.

---

## enable\_gssup\_sso

Enables SSO with a username and a password (that is, GSSUP) when set to `true`.

---

## enable\_user\_id\_logging

A boolean variable that enables logging of user IDs on the server side. Default is `false`.

Up until the release of Orbix 6.1 SP1, the GSP plug-in would log messages containing user IDs. For example:

```
[junit] Fri, 28 May 2004 12:17:22.0000000 [SLEEPY:3284]
      (IT_CSI:205) I - User alice authenticated successfully.
```

In some cases, however, it might not be appropriate to expose user IDs in the Orbix log. From Orbix 6.2 onward, the default behavior of the GSP plug-in is changed, so that user IDs are *not* logged by default. To restore the pre-Orbix 6.2 behavior and log user IDs, set this variable to `true`.

---

## enable\_x509\_sso

Enables certificate-based SSO when set to `true`.

---

## enforce\_secure\_comms\_to\_sso\_server

Enforces a secure SSL/TLS link between a client and the login service when set to `true`. When this setting is true, the value of the SSL/TLS client secure invocation policy does *not* affect the connection between the client and the login service.

Default is `true`.

---

## enable\_security\_service\_cert\_authentication

A boolean GSP policy that enables X.509 certificate-based authentication on the server side using the Artix security service.

Default is `false`.

---

## sso\_server\_certificate\_constraints

A special certificate constraints policy that applies *only* to the SSL/TLS connection between the client and the SSO login server. For details of the pattern constraint language, see [“Applying Constraints to Certificates” on page 401](#).

---

## use\_client\_load\_balancing

A boolean variable that enables load balancing over a cluster of security services. If an application is deployed in a domain that uses security service clustering, the application should be configured to use *client load balancing* (in this context, *client* means a client of the Artix security service). See also `policies:iiop_tls:load_balancing_mechanism`.

Default is `true`.

---

# plugins:http

The `plugins:http` namespace contains the following variables:

- `client:client_certificate`
- `client:client_certificate_chain`
- `client:client_private_key`
- `client:client_private_key_password`
- `client:trusted_root_certificates`
- `client:use_secure_sockets`
- `server:server_certificate`
- `server:server_certificate_chain`
- `server:server_private_key`
- `server:server_private_key_password`
- `server:trusted_root_certificates`
- `server:use_secure_sockets`

---

## client:client\_certificate

This variable specifies the full path to the PEM-encoded X.509 certificate issued by the certificate authority for the client. For example:

```
plugins:http:client:client_certificate =  
    "c:\aspen\x509\certs\key.cert.pem"
```

This setting is ignored if `plugins:http:client:use_secure_sockets` is `false`.

---

## client:client\_certificate\_chain

(Optional) This variable specifies the full path to the PEM-encoded X.509 certificate chain for the client. For example:

```
plugins:http:client:client_certificate_chain =  
    "c:\aspen\x509\certs\key.cert.pem"
```

This setting is ignored if `plugins:http:client:use_secure_sockets` is `false`.

---

## client:client\_private\_key

This variable specifies a PEM file containing the client certificate's encrypted private key. This private key enables the client to respond to a challenge from a server during an SSL/TLS handshake.

This setting is ignored if `plugins:http:client:use_secure_sockets` is `false`.

---

## client:client\_private\_key\_password

This variable specifies the password to decrypt the contents of the `client_private_key` file.

This setting is ignored if `plugins:http:client:use_secure_sockets` is `false`.

---

## client:trusted\_root\_certificates

This variable specifies the path to a file containing a concatenated list of CA certificates in PEM format. The client uses this CA list during the TLS handshake to verify that the server's certificate has been signed by a trusted CA.

This setting is ignored if `plugins:http:client:use_secure_sockets` is `false`.

---

## client:use\_secure\_sockets

This variable specifies whether the client wants to open a HTTPS connection (that is, HTTP running over SSL or TLS) or an insecure connection (that is, plain HTTP).

Valid values are `true`, for HTTPS, and `false`, for HTTP. The default is `false`.

---

## server:server\_certificate

This variable specifies the full path to the PEM-encoded X.509 certificate issued by the certificate authority for the server. For example:

```
plugins:http:server:server_certificate =  
    "c:\aspens\509\certs\key.cert.pem"
```

This setting is ignored if `plugins:http:server:use_secure_sockets` is `false`.

---

## server:server\_certificate\_chain

(Optional) This variable specifies the full path to the PEM-encoded X.509 certificate chain for the server. For example:

```
plugins:http:server:server_certificate_chain =  
    "c:\aspens\509\certs\key.cert.pem"
```

This setting is ignored if `plugins:http:server:use_secure_sockets` is `false`.

---

## server:server\_private\_key

This variable specifies a PEM file containing the server certificate's encrypted private key. This private key enables the server to respond to a challenge from a client during an SSL/TLS handshake.

This setting is ignored if `plugins:http:server:use_secure_sockets` is `false`.

---

## server:server\_private\_key\_password

This variable specifies the password to decrypt the contents of the `server_private_key` file.

This setting is ignored if `plugins:http:server:use_secure_sockets` is `false`.

## **server:trusted\_root\_certificates**

This variable specifies the path to a file containing a concatenated list of CA certificates in PEM format. The server uses this CA list during the TLS handshake to verify that the client's certificate has been signed by a trusted CA.

This setting is ignored if `plugins:http:server:use_secure_sockets` is `false`.

---

## **server:use\_secure\_sockets**

This variable specifies whether the server accepts HTTPS connection attempts (that is, HTTP running over SSL or TLS) or insecure connection attempts (that is, plain HTTP) from a client.

Valid values are `true`, for HTTPS, and `false`, for HTTP. The default is `false`.



---

# plugins:https

The `plugins:https` namespace contains the following variable:

- `ClassName`

---

## ClassName

(Java only) This variable specifies the class name of the `https` plug-in implementation. For example:

```
plugins:https:ClassName = "com.ionacorba.https.HTTPSPlugIn";
```

---

## plugins:iiop\_tls

The `plugins:iiop_tls` namespace contains the following variables:

- `buffer_pool:recycle_segments`
- `buffer_pool:segment_preallocation`
- `buffer_pools:max_incoming_buffers_in_pool`
- `buffer_pools:max_outgoing_buffers_in_pool`
- `delay_credential_gathering_until_handshake`
- `enable_iiop_1_0_client_support`
- `incoming_connections:hard_limit`
- `incoming_connections:soft_limit`
- `outgoing_connections:hard_limit`
- `outgoing_connections:soft_limit`
- `tcp_listener:reincarnate_attempts`
- `tcp_listener:reincarnation_retry_backoff_ratio`
- `tcp_listener:reincarnation_retry_delay`

---

### buffer\_pool:recycle\_segments

(Java only) When this variable is set, the `iiop_tls` plug-in reads this variable's value instead of the `plugins:iiop:buffer_pool:recycle_segments` variable's value.

---

### buffer\_pool:segment\_preallocation

(Java only) When this variable is set, the `iiop_tls` plug-in reads this variable's value instead of the `plugins:iiop:buffer_pool:segment_preallocation` variable's value.

---

## buffer\_pools:max\_incoming\_buffers\_in\_pool

(C++ only) When this variable is set, the `iiop_tls` plug-in reads this variable's value instead of the `plugins:iiop:buffer_pools:max_incoming_buffers_in_pool` variable's value.

---

## buffer\_pools:max\_outgoing\_buffers\_in\_pool

(C++ only) When this variable is set, the `iiop_tls` plug-in reads this variable's value instead of the `plugins:iiop:buffer_pools:max_outgoing_buffers_in_pool` variable's value.

---

## delay\_credential\_gathering\_until\_handshake

(Windows and Schannel only) This client configuration variable provides an alternative to using the `principal_sponsor` variables to specify an application's own certificate. When this variable is set to `true` and `principal_sponsor:use_principal_sponsor` is set to `false`, the client delays sending its certificate to a server. The client will wait until the server *explicitly* requests the client to send its credentials during the SSL/TLS handshake.

This configuration variable can be used in conjunction with the `plugins:schannel:prompt_with_credential_choice` configuration variable.

---

## enable\_iiop\_1\_0\_client\_support

This variable enables client-side interoperability of Artix SSL/TLS applications with legacy IIOP 1.0 SSL/TLS servers, which do not support IIOP 1.1.

The default value is `false`. When set to `true`, Artix SSL/TLS searches secure target IIOp 1.0 object references for legacy IIOp 1.0 SSL/TLS tagged component data, and attempts to connect on the specified port.

**Note:** This variable will not be necessary for most users.

---

## **incoming\_connections:hard\_limit**

Specifies the maximum number of incoming (server-side) connections permitted to IIOp. IIOp does not accept new connections above this limit. Defaults to -1 (disabled).

When this variable is set, the `iiop_tls` plug-in reads this variable's value instead of the `plugins:iiop:incoming_connections:hard_limit` variable's value.

Please see the chapter on ACM in the *CORBA Programmer's Guide* for further details.

---

## **incoming\_connections:soft\_limit**

Specifies the number of connections at which IIOp should begin closing incoming (server-side) connections. Defaults to -1 (disabled).

When this variable is set, the `iiop_tls` plug-in reads this variable's value instead of the `plugins:iiop:incoming_connections:soft_limit` variable's value.

Please see the chapter on ACM in the *CORBA Programmer's Guide* for further details.

---

## **outgoing\_connections:hard\_limit**

When this variable is set, the `iiop_tls` plug-in reads this variable's value instead of the `plugins:iiop:outgoing_connections:hard_limit` variable's value.

---

## outgoing\_connections:soft\_limit

When this variable is set, the `iiop_tls` plug-in reads this variable's value instead of the `plugins:iiop:outgoing_connections:soft_limit` variable's value.

---

## tcp\_listener:reincarnate\_attempts

(Windows only)

`plugins:iiop_tls:tcp_listener:reincarnate_attempts` specifies the number of times that a Listener recreates its listener socket after receiving a `SocketException`.

Sometimes a network error may occur, which results in a listening socket being closed. On Windows, you can configure the listener to attempt a reincarnation, which enables new connections to be established. This variable only affects Java and C++ applications on Windows. Defaults to 0 (no attempts).

---

## tcp\_listener:reincarnation\_retry\_backoff\_ratio

(Windows only)

`plugins:iiop_tls:tcp_listener:reincarnation_retry_delay` specifies a delay between reincarnation attempts. Data type is `long`. Defaults to 0 (no delay).

---

## tcp\_listener:reincarnation\_retry\_delay

(Windows only)

`plugins:iiop_tls:tcp_listener:reincarnation_retry_backoff_ratio` specifies the degree to which delays between retries increase from one retry to the next. Datatype is `long`. Defaults to 1.

---

## plugins:java\_server

In the context of Artix security, the variables in the `plugins:java_server` namespace are used only to configure the Artix security service. To deploy the security service, Artix exploits IONA's *generic server* (which is a feature originally developed for Orbix). The Artix security service is deployed into the following container hierarchy:

- *Generic server*—a simple container, originally developed for the Orbix product, which enables you to deploy CORBA services implemented in C++.
- *Java server plug-in*—a JNI-based adapter that plugs into the generic server, enabling you to deploy CORBA services implemented in Java.
- *JVM created by the Java server plug-in*—once it is loaded, the Java server plug-in creates a JVM instance to host a Java program.
- *Artix security service Java code*—you instruct the Java server plug-in to load the security service core (which is implemented in Java) by specifying the appropriate class to the `plugins:java_server:class` variable.

In addition to the configuration variables described in this section, you must also include the following setting in your configuration:

```
generic_server_plugin = "java_server";
```

Which instructs the generic server to load the Java server plug-in.

The `plugins:java_server` namespace contains the following variables:

- `class`
- `classpath`
- `jni_verbose`
- `shlib_name`
- `system_properties`
- `X_options`

---

## class

In the context of the Artix security service, this variable specifies the entry point to the core security service (the core security service is a pure Java program). There are two possible values:

- `com.iona.jbus.security.services.SecurityServer`—creates an Artix bus instance that takes its configuration from the `bus` sub-scope of the current configuration scope. This entry point is suitable for a security service that is accessed through a WSDL contract (for example, a HTTPS-based security service).
- `com.iona.corba.security.services.SecurityServer`—a CORBA-based implementation of the security service, which does *not* create an Artix bus instance. This entry point is suitable for running an IIOP/TLS-based security service.

---

## classpath

Specifies the `CLASSPATH` for the JVM instance created by the Java server plug-in. For the Artix security service, this `CLASSPATH` must point at the JAR file containing the implementation of the security service. For example:

```
plugins:java_server:classpath =
  "C:\artix_40/lib/artix/security_service/4.0/security_service-rt.jar";
```

The Java server plug-in ignores the contents of the `CLASSPATH` environment variable.

---

## jni\_verbose

A boolean variable that instructs the JVM to output JNI-level diagnostics, which can be helpful for troubleshooting. When `true`, the JVM-generated diagnostic messages are sent to the Artix logging stream; when `false`, the diagnostic messages are suppressed.

---

## shlib\_name

Specifies the abbreviated name of the shared library that implements the `java_server` plug-in. This variable must always be set as follows:

```
plugins:java_server:shlib_name = "it_java_server";
```

---

## system\_properties

Specifies a list of Java system properties to the JVM created by the Java server plug-in. For example, the Artix security service requires the following Java system property settings:

```
plugins:java_server:system_properties =
["org.omg.CORBA.ORBClass=com.ion.corba.art.artimpl.ORBImpl",
"org.omg.CORBA.ORBSingletonClass=com.ion.corba.art.artimpl.ORBSingleton",
"is2.properties=%{INSTALL_DIR}/%{PRODUCT_NAME}/%{PRODUCT_VERSION}/demos/security/full_security/etc/is2.properties.FILE",
"java.endorsed.dirs=%{INSTALL_DIR}/%{PRODUCT_NAME}/%{PRODUCT_VERSION}/lib/endorsed"];
```

Where each item in the list specifies a Java system property, as follows:

```
<PropertyName>=<PropertyValue>
```

---

## X\_options

Specifies a list of non-standard, `-x`, options to the JVM created by the Java server plug-in. In contrast to the way these options are specified to the `java` command-line tool, you must omit the `-x` prefix in the `x_options` list.

For example:

```
plugins:java_server:X_options = ["rs"];
```

To find out more about the non-standard JVM options, type `java -X -help` at the command line (using Sun's implementation of the JVM).



---

# plugins:kdm

The `plugins:kdm` namespace contains the following variables:

- `cert_constraints`
- `iiop_tls:port`
- `checksums_optional`

---

## cert\_constraints

Specifies the list of certificate constraints for principals attempting to open a connection to the KDM server plug-in. See [“Applying Constraints to Certificates” on page 401](#) for a description of the certificate constraint syntax.

To protect the sensitive data stored within it, the KDM applies restrictions on which entities are allowed talk to it. A security administrator should choose certificate constraints that restrict access to the following principals:

- The locator service (requires read-only access).
- The `kdm_admin` plug-in, which is normally loaded into the `itadmin` utility (requires read-write access).

All other principals should be blocked from access. For example, you might define certificate constraints similar to the following:

```
plugins:kdm:cert_constraints =  
  ["C=US,ST=Massachusetts,O=ABigBank*,CN=Secure admin*",  
   "C=US,ST=Boston,O=ABigBank*,CN=Orbix2000 Locator Service*"]
```

Your choice of certificate constraints will depend on the naming scheme for your subject names.

---

## **iiop\_tls:port**

Specifies the well known IP port on which the KDM server listens for incoming calls.

---

## **checksums\_optional**

When equal to `false`, the secure information associated with a server must include a checksum; when equal to `true`, the presence of a checksum is optional. Default is `false`.

---

# plugins:kdm\_adm

The `plugins:kdm_adm` namespace contains the following variable:

- [cert\\_constraints](#)

---

## cert\_constraints

Specifies the list of certificate constraints that are applied when the KDM administration plug-in authenticates the KDM server. See [“Applying Constraints to Certificates” on page 401](#) for a description of the certificate constraint syntax.

The KDM administration plug-in requires protection against attack from applications that try to impersonate the KDM server. A security administrator should, therefore, choose certificate constraints that restrict access to trusted KDM servers only. For example, you might define certificate constraints similar to the following:

```
plugins:kdm_adm:cert_constraints =  
  ["C=US,ST=Massachusetts,O=ABigBank*,CN=IT_KDM*"];
```

Your choice of certificate constraints will depend on the naming scheme for your subject names.

---

## plugins:login\_client

The `plugins:login_client` namespace contains the following variables:

- `wsdl_url`

---

### **wsdl\_url**

Specifies the location of the login service WSDL to the `login_client` plug-in. The value of this variable can either be a relative pathname or an URL. The `login_client` requires access to the login service WSDL in order to obtain details of the physical contract (for example, host and IP port).

---

## plugins:login\_service

The `plugins:login_service` namespace contains the following variables:

- `wsdl_url`

---

### **wsdl\_url**

Specifies the location of the login service WSDL to the `login_service` plug-in. The value of this variable can either be a relative pathname or an URL. The `login_service` requires access to the login service WSDL in order to obtain details of the physical contract (for example, host and IP port).

---

## plugins:schannel

The `plugins:schannel` namespace contains the following variable:

- [prompt\\_with\\_credential\\_choice](#)

---

### prompt\_with\_credential\_choice

(Windows and Schannel only) Setting both this variable and the `plugins:iiop_tls:delay_credential_gathering_until_handshake` variable to `true` on the client side allows the user to choose which credentials to use for the server connection. The choice of credentials offered to the user is based on the trusted CAs sent to the client in an SSL/TLS handshake message.

If `prompt_with_credential_choice` is set to `false`, runtime chooses the first certificate it finds in the certificate store that meets the applicable constraints.

The certificate prompt can be replaced by implementing an IDL interface and registering it with the ORB.

---

# plugins:security

The `plugins:security` namespace contains the following variable:

- `direct_persistence`
- `iiop_tls:addr_list`
- `iiop_tls:host`
- `iiop_tls:port`
- `log4j_to_local_log_stream`
- `share_credentials_across_orbs`

---

## direct\_persistence

A boolean variable that specifies whether or not the security service runs on a fixed IP port (for an IIOP/TLS-based security service). You must always set this variable to `true` in the security service's configuration scope, because the security service *must* run on a fixed port.

---

## iiop\_tls:addr\_list

When the security service is configured as a cluster, you must use this variable to list the addresses of all of the security services in the cluster.

The first entry, *not* prefixed by a `+` sign, must specify the address of the current security service instance. The remaining entries, prefixed by a `+` sign, must specify the addresses of the other services in the cluster (the `+` sign indicates that an entry affects only the contents of the generated IOR, not the security service's listening port).

For example, to configure the first instance of a cluster consisting of three security service instances—with addresses `security01:5001`, `security02:5002`, and `security03:5003`—you would initialize the address list as follows:

```
plugins:security:iiop_tls:addr_list = ["security01:5001",
    "+security02:5002", "+security03:5003"];
```

---

## iiop\_tls:host

Specifies the hostname where the security service is running. This hostname will be embedded in the security service's IOR (for an IIOP/TLS-based security service).

---

## iiop\_tls:port

Specifies the fixed IP port where the security service listens for incoming connections. This IP port also gets embedded in the security service's IOR (for an IIOP/TLS-based security service).

---

## log4j\_to\_local\_log\_stream

Redirects the Artix security service's log4j output to the local log stream. In the Artix security service's configuration scope, you can set the `plugins:security:log4j_to_local_log_stream` variable to one of the following values:

- `true`—the security service log4j output is sent to the local log stream. This requires that the `local_log_stream` plug-in is present in the `orb_plugins` list.
- `false`—(*default*) the log4j output is controlled by the `log4j.properties` file (whose location is specified in the `is2.properties` file).

When redirecting log4j messages to the local log stream, you can control the log4j logging level using Artix event log filters. You can specify Artix event log filters with the following setting in the Artix configuration file:

```
event_log:filters = ["IT_SECURITY=LoggingLevels"];
```

The `IT_SECURITY` tag configures the logging levels for the Artix security service (which includes the redirected log4j stream). log4j has five logging levels: `DEBUG`, `INFO`, `WARN`, `ERROR`, and `FATAL`. To select a particular log4j logging level (for example, `WARN`), replace `LoggingLevels` by that logging level plus all of the higher logging levels (for example, `WARN+ERROR+FATAL`).



For example, you can configure the Artix security service to send log4j logging to the local log stream, as follows:

```
# Artix Configuration File
security_service
{
  orb_plugins = ["local_log_stream", "iiop_profile", "giop",
"iiop_tls"];
  plugins:security:log4j_to_local_log_stream = "true";

  # Log all log4j messages at level WARN and above
  event_log:filters = ["IT_SECURITY=WARN+ERROR+FATAL"];
  ...
};
```

---

## share\_credentials\_across\_orbs

Enables own security credentials to be shared across ORBs. Normally, when you specify an own SSL/TLS credential (using the principal sponsor or the principal authenticator), the credential is available only to the ORB that created it. By setting the `plugins:security:share_credentials_across_orbs` variable to `true`, however, the own SSL/TLS credentials created by one ORB are automatically made available to any other ORBs that are configured to share credentials.

See also `principal_sponsor:csi:use_existing_credentials` for details of how to enable sharing of CSI credentials.

Default is `false`.

---

## plugins:wSDL\_publish

The `plugins:wSDL_publish` namespace contains the following variables:

- `enable_secure_wSDL_publish`

---

### enable\_secure\_wSDL\_publish

A boolean variable that enables certain security features of the WSDL publishing service that are required whenever the WSDL publishing service is configured to use the HTTPS protocol. Set this variable to `true`, if the WSDL publishing service is configured to use HTTPS; otherwise, set it to `false`.

Default is `false`.

For example, to configure the WSDL publishing service to use HTTPS, you should include the following in your program's configuration scope:

```
# Artix Configuration File
secure_server
{
    orb_plugins = [ ... , "wSDL_publish", "at_http", "https"];

    plugins:wSDL_publish:publish_port = "2222";
    plugins:wSDL_publish:enable_secure_wSDL_publish = "true";
    plugins:at_http:server:use_secure_sockets = "true";

    # Other HTTPS-related settings
    ...
};
```

The `plugins:at_http:server:use_secure_sockets` setting is needed to enable HTTPS for the WSDL publishing service.

**Note:** You must set *both* `plugins:wSDL_publish:enable_secure_wSDL_publish` and `plugins:at_http:server:use_secure_sockets` to `true`, when enabling HTTPS for the WSDL publish plug-in.

---

# policies

The `policies` namespace defines the default CORBA policies for an ORB. Many of these policies can also be set programmatically from within an application. SSL/TLS-specific variables in the `policies` namespace include:

- `allow_unauthenticated_clients_policy`
- `certificate_constraints_policy`
- `client_secure_invocation_policy:requires`
- `client_secure_invocation_policy:supports`
- `max_chain_length_policy`
- `mechanism_policy:accept_v2_hellos`
- `mechanism_policy:ciphersuites`
- `mechanism_policy:protocol_version`
- `session_caching_policy`
- `target_secure_invocation_policy:requires`
- `target_secure_invocation_policy:supports`
- `trusted_ca_list_policy`

---

## allow\_unauthenticated\_clients\_policy

A generic variable that sets this policy both for `iiop_tls` and `https`. To set this policy specifically for the IIOP/TLS protocol, set the `policies:iiop_tls:allow_unauthenticated_clients_policy` variable, which takes precedence.

A boolean variable that specifies whether a server will allow a client to establish a secure connection without sending a certificate. Default is `false`.

This configuration variable is applicable *only* in the special case where the target secure invocation policy is set to require `NoProtection` (a semi-secure server).

---

## certificate\_constraints\_policy

A generic variable that sets this policy both for `iiop_tls` and `https`. To set this policy specifically for the IIOP/TLS protocol, set the `policies:iiop_tls:certificate_constraints_policy` variable, which takes precedence.

A list of constraints applied to peer certificates—see [“Applying Constraints to Certificates” on page 401](#). If a peer certificate fails to match any of the constraints, the certificate validation step will fail.

The policy can also be set programmatically using the `IT_TLS_API::CertConstraintsPolicy` CORBA policy. Default is no constraints.

---

## client\_secure\_invocation\_policy:requires

A generic variable that sets this policy both for `iiop_tls` and `https`. To set this policy specifically for the IIOP/TLS protocol, set the `policies:iiop_tls:client_secure_invocation_policy:requires` variable, which takes precedence.

Specifies the minimum level of security required by a client. The value of this variable is specified as a list of association options—see the *Artix Security Guide* for more details about association options.

In accordance with CORBA security, this policy cannot be downgraded programmatically by the application.

---

## client\_secure\_invocation\_policy:supports

A generic variable that sets this policy both for `iiop_tls` and `https`. To set this policy specifically for the IIOp/TLS protocol, set the `policies:iiop_tls:client_secure_invocation_policy:supports` variable, which takes precedence.

Specifies the initial maximum level of security supported by a client. The value of this variable is specified as a list of association options—see the *Artix Security Guide* for more details about association options.

This policy can be upgraded programmatically using either the `QOP` or the `EstablishTrust` policies.

---

## max\_chain\_length\_policy

A generic variable that sets this policy both for `iiop_tls` and `https`. To set this policy specifically for the IIOp/TLS protocol, set the `policies:iiop_tls:max_chain_length_policy` variable, which takes precedence.

`max_chain_length_policy` specifies the maximum certificate chain length that an ORB will accept. The policy can also be set programmatically using the `IT_TLS_API::MaxChainLengthPolicy` CORBA policy. Default is 2.

**Note:** The `max_chain_length_policy` is not currently supported on the z/OS platform.

---

## mechanism\_policy:accept\_v2\_hellos

A generic variable that sets this policy both for `iiop_tls` and `https`. To set this policy for a specific protocol, set `policies:iiop_tls:mechanism_policy:accept_v2_hellos` or `policies:https:mechanism_policy:accept_v2_hellos` respectively for IIOp/TLS or HTTPS.

The `accept_v2_hellos` policy is a special setting that facilitates interoperability with an Artix application deployed on the z/OS platform. When `true`, the Artix application accepts V2 client hellos, but continues the

handshake using either the SSL\_V3 or TLS\_V1 protocol. When `false`, the Artix application throws an error, if it receives a V2 client hello. The default is `false`.

For example:

```
policies:mechanism_policy:accept_v2_hellos = "true";
```

---

## mechanism\_policy:ciphersuites

A generic variable that sets this policy both for `iiop_tls` and `https`. To set this policy for a specific protocol, set

`policies:iiop_tls:mechanism_policy:ciphersuites` Or  
`policies:https:mechanism_policy:ciphersuites` respectively for IIOP/TLS or HTTPS.

`mechanism_policy:ciphersuites` specifies a list of cipher suites for the default mechanism policy. One or more of the cipher suites shown in [Table 10](#) can be specified in this list.

**Table 10:** *Mechanism Policy Cipher Suites*

Null Encryption, Integrity and Authentication Ciphers	Standard Ciphers
RSA_WITH_NULL_MD5	RSA_EXPORT_WITH_RC4_40_MD5
RSA_WITH_NULL_SHA	RSA_WITH_RC4_128_MD5
	RSA_WITH_RC4_128_SHA
	RSA_EXPORT_WITH_DES40_CBC_SHA
	RSA_WITH_DES_CBC_SHA
	RSA_WITH_3DES_EDE_CBC_SHA

If you do not specify the list of cipher suites explicitly, all of the null encryption ciphers are disabled and all of the non-export strength ciphers are supported by default.

---

## mechanism\_policy:protocol\_version

A generic variable that sets this policy both for `iiop_tls` and `https`. To set this policy for a specific protocol, set

`policies:iiop_tls:mechanism_policy:protocol_version` OR  
`policies:https:mechanism_policy:protocol_version` respectively for IIOp/TLS or HTTPS.

`mechanism_policy:protocol_version` specifies the list of protocol versions used by a security capsule (ORB instance). The list can include one or more of the values `SSL_V3` and `TLS_V1`. For example:

```
policies:mechanism_policy:protocol_version=["TLS_V1", "SSL_V3"];
```

---

## session\_caching\_policy

A generic variable that sets this policy both for `iiop_tls` and `https`. To set this policy specifically for the IIOp/TLS protocol, set the

`policies:iiop_tls:session_caching_policy` variable, which takes precedence.

`session_caching_policy` specifies whether an ORB caches the session information for secure associations when acting in a client role, a server role, or both. The purpose of session caching is to enable closed connections to be re-established quickly. The following values are supported:

`CACHE_NONE`(default)

`CACHE_CLIENT`

`CACHE_SERVER`

`CACHE_SERVER_AND_CLIENT`

The policy can also be set programmatically using the `IT_TLS_API::SessionCachingPolicy` CORBA policy.

---

## target\_secure\_invocation\_policy:requires

A generic variable that sets this policy both for `iiop_tls` and `https`. To set this policy specifically for the IIOP/TLS protocol, set the `policies:iiop_tls:target_secure_invocation_policy:requires` variable, which takes precedence.

`target_secure_invocation_policy:requires` specifies the minimum level of security required by a server. The value of this variable is specified as a list of association options.

**Note:** In accordance with CORBA security, this policy cannot be downgraded programmatically by the application.

---

## target\_secure\_invocation\_policy:supports

A generic variable that sets this policy both for `iiop_tls` and `https`. To set this policy specifically for the IIOP/TLS protocol, set the `policies:iiop_tls:target_secure_invocation_policy:supports` variable, which takes precedence.

`supports` specifies the maximum level of security supported by a server. The value of this variable is specified as a list of association options. This policy can be upgraded programmatically using either the `QOP` or the `EstablishTrust` policies.



---

## trusted\_ca\_list\_policy

A generic variable that sets this policy both for `iiop_tls` and `https`. To set this policy for a specific protocol, set

`policies:iiop_tls:trusted_ca_list_policy` OR

`policies:https:trusted_ca_list_policy` respectively for IIOP/TLS or HTTPS.

`trusted_ca_list_policy` specifies a list of filenames, each of which contains a concatenated list of CA certificates in PEM format. The aggregate of the CAs in all of the listed files is the set of trusted CAs.

For example, you might specify two files containing CA lists as follows:

```
policies:trusted_ca_list_policy =  
  ["install_dir/asp/version/etc/tls/x509/ca/ca_list1.pem",  
   "install_dir/asp/version/etc/tls/x509/ca/ca_list_extra.pem"];
```

The purpose of having more than one file containing a CA list is for administrative convenience. It enables you to group CAs into different lists and to select a particular set of CAs for a security domain by choosing the appropriate CA lists.

---

## policies:asp

The `policies:asp` namespace contains the following variables:

- `enable_security`
  - `enable_security`
  - `enable_sso`
  - `load_balancing_policy`
  - `use_artix_proxies`
- 

### enable\_authorization

A boolean variable that specifies whether Artix should enable authorization using the Artix Security Framework. Default is `true`.

**Note:** From Artix 4.0 onwards, the default value of `policies:asp:enable_authorization` is `true`. For versions of Artix prior to 4.0, the default value of `policies:asp:enable_authorization` is `false`.

---

### enable\_security

A boolean variable that specifies whether Artix should enable security using the Artix Security Framework. When this variable is set to `false`, all security features that depend on the `artix_security` plug-in (that is, authentication and authorization using the Artix security service) are disabled. Default is `true`.

**Note:** From Artix 4.0 onwards, the default value of `policies:asp:enable_security` is `true`. For versions of Artix prior to 4.0, the default value of `policies:asp:enable_security` is `false`.

---

### enable\_sso

This configuration variable is obsolete and has no effect.

---

## load\_balancing\_policy

When client load balancing is enabled, this variable specifies how often the Artix security plug-in reconnects to a node in the security service cluster. There are two possible values for this policy:

- `per-server`—(*the default*) after selecting a particular security service from the cluster, the client remains connected to that security service instance for the rest of the session.
- `per-request`—for each new request, the Artix security plug-in selects and connects to a new security service node (in accordance with the algorithm specified by `policies:iiop_tls:load_balancing_mechanism`).

**Note:** The process of re-establishing a secure connection with every new request imposes a significant performance overhead. Therefore, the `per-request` policy value is *not* recommended for most deployments.

This policy is used in conjunction with the `plugins:asp:enable_security_service_load_balancing` and `policies:iiop_tls:load_balancing_mechanism` configuration variables. Default is `per-server`.

---

## use\_artix\_proxies

A boolean variable that specifies whether a client of the Artix security service connects to the security service through a WSDL contract or through a CORBA object reference. The `policies:asp:use_artix_proxies` variable can have the following values:

- `true`—connect to the security service through a WSDL contract. The location of the security service WSDL contract can be specified using the `bus:initial_contract:url:isf_service` configuration variable.
- `false`—connect to the security service through a CORBA object reference. The object reference is specified by the `initial_references:IT_SecurityService:reference` configuration variable.

Default is `false`.

---

# policies:bindings

The `policies:bindings` namespace contains the following variables:

- [corba:gssup\\_propagation](#)
- [corba:token\\_propagation](#)
- [soap:gssup\\_propagation](#)
- [soap:token\\_propagation](#)

---

## corba:gssup\_propagation

A boolean variable that can be used in a SOAP-to-CORBA router to enable the transfer of incoming SOAP credentials into outgoing CORBA credentials.

The CORBA binding extracts the username and password credentials from incoming SOAP/HTTP invocations and inserts them into an outgoing GSSUP credentials object, to be transmitted using CSI authentication over transport. The domain name in the outgoing GSSUP credentials is set to a blank string. Default is `false`.

---

## corba:token\_propagation

A boolean variable that can be used in a SOAP-to-CORBA router to enable the transfer of an SSO token from an incoming SOAP request into an outgoing CORBA request.

The CORBA binding extracts the SSO token from incoming SOAP/HTTP invocations and inserts the token into an outgoing IIOP request, to be transmitted using CSI identity assertion.

---

## soap:gssup\_propagation

A boolean variable that can be used in a CORBA-to-SOAP router to enable the transfer of incoming CORBA credentials into outgoing SOAP credentials.

The SOAP binding extracts the username and password from incoming IIOp invocations (where the credentials are embedded in a GIOP service context and encoded according to the CSI and GSSUP standards), and inserts them into an outgoing SOAP header, encoded using the WSSE standard.

Default is `false`.

---

## **soap:token\_propagation**

A boolean variable that can be used in a CORBA-to-SOAP router to enable the transfer of an SSO token from an incoming CORBA request into an outgoing SOAP request.

The SOAP binding extracts the SSO token from an incoming IIOp request and inserts the token into the header of an outgoing SOAP/HTTP request.

---

# policies:csi

The `policies:csi` namespace includes variables that specify settings for Common Secure Interoperability version 2 (CSlv2):

- `attribute_service:backward_trust:enabled`
- `attribute_service:client_supports`
- `attribute_service:target_supports`
- `auth_over_transport:authentication_service`
- `auth_over_transport:client_supports`
- `auth_over_transport:server_domain_name`
- `auth_over_transport:target_requires`
- `auth_over_transport:target_supports`

---

## attribute\_service:backward\_trust:enabled

(Obsolete)

---

## attribute\_service:client\_supports

`attribute_service:client_supports` is a client-side policy that specifies the association options supported by the CSlv2 attribute service (principal propagation). The only association option that can be specified is `IdentityAssertion`. This policy is normally specified in an intermediate server so that it propagates CSlv2 identity tokens to a target server. For example:

```
policies:csi:attribute_service:client_supports =  
    ["IdentityAssertion"];
```

---

## attribute\_service:target\_supports

`attribute_service:target_supports` is a server-side policy that specifies the association options supported by the CSIV2 attribute service (principal propagation). The only association option that can be specified is `IdentityAssertion`. For example:

```
policies:csi:attribute_service:target_supports =  
    ["IdentityAssertion"];
```

---

## auth\_over\_transport:authentication\_service

(Java CSI plug-in only) The name of a Java class that implements the `IT_CSI::AuthenticateGSSUPCredentials` IDL interface. The authentication service is implemented as a callback object that plugs into the CSIV2 framework on the server side. By replacing this class with a custom implementation, you could potentially implement a new security technology domain for CSIV2.

By default, if no value for this variable is specified, the Java CSI plug-in uses a default authentication object that always returns `false` when the `authenticate()` operation is called.

---

## auth\_over\_transport:client\_supports

`auth_over_transport:client_supports` is a client-side policy that specifies the association options supported by CSIV2 authorization over transport. The only association option that can be specified is `EstablishTrustInClient`. For example:

```
policies:csi:auth_over_transport:client_supports =  
    ["EstablishTrustInClient"];
```



---

## auth\_over\_transport:server\_domain\_name

The iSF security domain (CSlv2 authentication domain) to which this server application belongs. The iSF security domains are administered within an overall security technology domain.

The value of the `server_domain_name` variable will be embedded in the IORs generated by the server. A CSlv2 client about to open a connection to this server would check that the domain name in its own CSlv2 credentials matches the domain name embedded in the IOR.

---

## auth\_over\_transport:target\_requires

`auth_over_transport:target_requires` is a server-side policy that specifies the association options required for CSlv2 authorization over transport. The only association option that can be specified is `EstablishTrustInClient`. For example:

```
policies:csi:auth_over_transport:target_requires =  
  ["EstablishTrustInClient"];
```

---

## auth\_over\_transport:target\_supports

`auth_over_transport:target_supports` is a server-side policy that specifies the association options supported by CSlv2 authorization over transport. The only association option that can be specified is `EstablishTrustInClient`. For example:

```
policies:csi:auth_over_transport:target_supports =  
  ["EstablishTrustInClient"];
```

---

## policies:external\_token\_issuer

The `policies:external_token_issuer` namespace contains the following variables:

- `client_certificate_constraints`

---

### client\_certificate\_constraints

To facilitate interoperability with Artix on the mainframe, the Artix security service can be configured to issue security tokens based on a username only (no password required). This feature is known as the *external token issuer*. Because this feature could potentially open a security hole in the Artix security service, the external token issuer is made available *only* to those applications that present a certificate matching the constraints specified in `policies:external_token_issuer:client_certificate_constraints`. For details of how to specify certificate constraints, see [“Applying Constraints to Certificates” on page 401](#).

For example, by inserting the following setting into the security service’s configuration scope in the Artix configuration file, you would effectively disable the external token issuer (recommended for deployments that do not need to interoperate with the mainframe).

```
# DISABLE the security service’s external token issuer.  
# Note: The empty list matches no certificates.  
#  
policies:external_token_issuer:client_certificate_constraints =  
    [];
```

This configuration variable must be set in the security server’s configuration scope, otherwise the security server will not start.

---

## policies:https

The `policies:https` namespace contains variables used to configure the https plugin. It contains the following variables:

- `mechanism_policy:accept_v2_hellos`
- `mechanism_policy:ciphersuites`
- `mechanism_policy:protocol_version`
- `trusted_ca_list_policy`

---

### mechanism\_policy:accept\_v2\_hellos

This HTTPS-specific policy overrides the generic `policies:mechanism_policy:accept_v2_hellos` policy.

The `accept_v2_hellos` policy is a special setting that facilitates HTTPS interoperability with certain Web browsers. Many Web browsers send SSL V2 client hellos, because they do not know what SSL version the server supports.

When `true`, the Artix server accepts V2 client hellos, but continues the handshake using either the `SSL_V3` or `TLS_V1` protocol. When `false`, the Artix server throws an error, if it receives a V2 client hello. The default is `true`.

**Note:** This default value is deliberately different from the `policies:iioptls:mechanism_policy:accept_v2_hellos` default value.

For example:

```
policies:https:mechanism_policy:accept_v2_hellos = "true";
```

---

## mechanism\_policy:ciphersuites

Specifies a list of cipher suites for the default mechanism policy. One or more of the following cipher suites can be specified in this list:

**Table 11:** *Mechanism Policy Cipher Suites*

Null Encryption, Integrity and Authentication Ciphers	Standard Ciphers
RSA_WITH_NULL_MD5	RSA_EXPORT_WITH_RC4_40_MD5
RSA_WITH_NULL_SHA	RSA_WITH_RC4_128_MD5
	RSA_WITH_RC4_128_SHA
	RSA_EXPORT_WITH_DES40_CBC_SHA
	RSA_WITH_DES_CBC_SHA
	RSA_WITH_3DES_EDE_CBC_SHA

If you do not specify the list of cipher suites explicitly, all of the null encryption ciphers are disabled and all of the non-export strength ciphers are supported by default.

---

## mechanism\_policy:protocol\_version

This HTTPS-specific policy overrides the generic `policies:mechanism_policy:protocol_version` policy.

Specifies the list of protocol versions used by a security capsule (ORB instance). Can include one or more of the following values:

TLS\_V1  
SSL\_V3

The default setting is `SSL_V3` and `TLS_V1`.

For example:

```
policies:https:mechanism_policy:protocol_version = ["TLS_V1",
"SSL_V3"];
```

---

## trusted\_ca\_list\_policy

Contains a list of filenames (or a single filename), each of which contains a concatenated list of CA certificates in PEM format. The aggregate of the CAs in all of the listed files is the set of trusted CAs.

For example, you might specify two files containing CA lists as follows:

```
policies:trusted_ca_list_policy =  
  ["ASPInstallDir/asp/6.0/etc/tls/x509/ca/ca_list1.pem",  
   "ASPInstallDir/asp/6.0/etc/tls/x509/ca/ca_list_extra.pem"];
```

The purpose of having more than one file containing a CA list is for administrative convenience. It enables you to group CAs into different lists and to select a particular set of CAs for a security domain by choosing the appropriate CA lists.

---

## policies:iiop\_tls

The `policies:iiop_tls` namespace contains variables used to set IIOP-related policies for a secure environment. These settings affect the `iiop_tls` plugin. It contains the following variables:

- `allow_unauthenticated_clients_policy`
- `buffer_sizes_policy:default_buffer_size`
- `buffer_sizes_policy:max_buffer_size`
- `certificate_constraints_policy`
- `client_secure_invocation_policy:requires`
- `client_secure_invocation_policy:supports`
- `client_version_policy`
- `connection_attempts`
- `connection_retry_delay`
- `load_balancing_mechanism`
- `max_chain_length_policy`
- `mechanism_policy:accept_v2_hellos`
- `mechanism_policy:ciphersuites`
- `mechanism_policy:protocol_version`
- `server_address_mode_policy:local_domain`
- `server_address_mode_policy:local_hostname`
- `server_address_mode_policy:port_range`
- `server_address_mode_policy:publish_hostname`
- `server_version_policy`
- `session_caching_policy`
- `target_secure_invocation_policy:requires`
- `target_secure_invocation_policy:supports`
- `tcp_options_policy:no_delay`
- `tcp_options_policy:recv_buffer_size`
- `tcp_options_policy:send_buffer_size`
- `trusted_ca_list_policy`

---

## allow\_unauthenticated\_clients\_policy

A boolean variable that specifies whether a server will allow a client to establish a secure connection without sending a certificate. Default is `false`. This configuration variable is applicable *only* in the special case where the target secure invocation policy is set to require `NoProtection` (a semi-secure server).

---

## buffer\_sizes\_policy:default\_buffer\_size

When this policy is set, the `iiop_tls` plug-in reads this policy's value instead of the `policies:iiop:buffer_sizes_policy:default_buffer_size` policy's value.

`buffer_sizes_policy:default_buffer_size` specifies, in bytes, the initial size of the buffers allocated by IIOP. Defaults to 16000. This value must be greater than 80 bytes, and must be evenly divisible by 8.

---

## buffer\_sizes\_policy:max\_buffer\_size

When this policy is set, the `iiop_tls` plug-in reads this policy's value instead of the `policies:iiop:buffer_sizes_policy:max_buffer_size` policy's value.

`buffer_sizes_policy:max_buffer_size` specifies the maximum buffer size permitted by IIOP, in kilobytes. Defaults to 512. A value of -1 indicates unlimited size. If not unlimited, this value must be greater than 80.

---

## certificate\_constraints\_policy

A list of constraints applied to peer certificates—see the discussion of certificate constraints in the Artix security guide for the syntax of the pattern constraint language. If a peer certificate fails to match any of the constraints, the certificate validation step will fail.

The policy can also be set programmatically using the `IT_TLS_API::CertConstraintsPolicy` CORBA policy. Default is no constraints.

---

## client\_secure\_invocation\_policy:requires

Specifies the minimum level of security required by a client. The value of this variable is specified as a list of association options—see the *Artix Security Guide* for more details about association options.

In accordance with CORBA security, this policy cannot be downgraded programmatically by the application.

---

## client\_secure\_invocation\_policy:supports

Specifies the initial maximum level of security supported by a client. The value of this variable is specified as a list of association options—see the *Artix Security Guide* for more details about association options.

This policy can be upgraded programmatically using either the `QOP` or the `EstablishTrust` policies.

---

## client\_version\_policy

`client_version_policy` specifies the highest IOP version used by clients. A client uses the version of IOP specified by this variable, or the version specified in the IOR profile, whichever is lower. Valid values for this variable are: 1.0, 1.1, and 1.2.

For example, the following file-based configuration entry sets the server IOP version to 1.1.

```
policies:iop:server_version_policy="1.1";
```

The following `itadmin` command set this variable:

```
itadmin variable modify -type string -value "1.1"  
policies:iop:server_version_policy
```

---

## connection\_attempts

`connection_attempts` specifies the number of connection attempts used when creating a connected socket using a Java application. Defaults to 5.



---

## connection\_retry\_delay

`connection_retry_delay` specifies the delay, in seconds, between connection attempts when using a Java application. Defaults to 2.

---

## load\_balancing\_mechanism

Specifies the load balancing mechanism for the client of a security service cluster (see also `plugins:gsp:use_client_load_balancing` and `plugins:asp:enable_security_service_load_balancing`). In this context, a client can also be an *Artix* server. This policy only affects connections made using IORs that contain multiple addresses. The `iiop_tls` plug-in load balances over the addresses embedded in the IOR.

The following mechanisms are supported:

- `random`—choose one of the addresses embedded in the IOR at random (this is the default).
- `sequential`—choose the first address embedded in the IOR, moving on to the next address in the list only if the previous address could not be reached.

---

## max\_chain\_length\_policy

This policy overrides `policies:max_chain_length_policy` for the `iiop_tls` plugin.

The maximum certificate chain length that an ORB will accept.

The policy can also be set programmatically using the `IT_TLS_API::MaxChainLengthPolicy` CORBA policy. Default is 2.

**Note:** The `max_chain_length_policy` is not currently supported on the z/OS platform.

---

## mechanism\_policy:accept\_v2\_hellos

This IIOP/TLS-specific policy overrides the generic `policies:mechanism_policy:accept_v2_hellos` policy.

The `accept_v2_hellos` policy is a special setting that facilitates interoperability with an Artix application deployed on the z/OS platform. Artix security on the z/OS platform is based on IBM's System/SSL toolkit, which implements SSL version 3, but does so by using SSL version 2 hellos as part of the handshake. This form of handshake causes interoperability problems, because applications on other platforms identify the handshake as an SSL version 2 handshake. The misidentification of the SSL protocol version can be avoided by setting the `accept_v2_hellos` policy to `true` in the non-z/OS application (this bug also affects some old versions of Microsoft Internet Explorer).

When `true`, the Artix application accepts V2 client hellos, but continues the handshake using either the `SSL_V3` or `TLS_V1` protocol. When `false`, the Artix application throws an error, if it receives a V2 client hello. The default is `false`.

**Note:** This default value is deliberately different from the `policies:https:mechanism_policy:accept_v2_hellos` default value.

For example:

```
policies:iiop_tls:mechanism_policy:accept_v2_hellos = "true";
```

## mechanism\_policy:ciphersuites

This policy overrides `policies:mechanism_policy:ciphersuites` for the `iiop_tls` plugin.

Specifies a list of cipher suites for the default mechanism policy. One or more of the following cipher suites can be specified in this list:

**Table 12:** Mechanism Policy Cipher Suites

Null Encryption, Integrity and Authentication Ciphers	Standard Ciphers
RSA_WITH_NULL_MD5	RSA_EXPORT_WITH_RC4_40_MD5
RSA_WITH_NULL_SHA	RSA_WITH_RC4_128_MD5
	RSA_WITH_RC4_128_SHA
	RSA_EXPORT_WITH_DES40_CBC_SHA

**Table 12:** Mechanism Policy Cipher Suites

Null Encryption, Integrity and Authentication Ciphers	Standard Ciphers
	RSA_WITH_DES_CBC_SHA
	RSA_WITH_3DES_EDE_CBC_SHA

If you do not specify the list of cipher suites explicitly, all of the null encryption ciphers are disabled and all of the non-export strength ciphers are supported by default.

---

## mechanism\_policy:protocol\_version

This IIOp/TLS-specific policy overrides the generic `policies:mechanism_policy:protocol_version` policy.

Specifies the list of protocol versions used by a security capsule (ORB instance). Can include one or more of the following values:

TLS\_V1  
 SSL\_V3  
 SSL\_V2V3 (*Deprecated*)

The default setting is `SSL_V3` and `TLS_V1`.

For example:

```
policies:iiop_tls:mechanism_policy:protocol_version = ["TLS_V1",
"SSL_V3"];
```

The `SSL_V2V3` value is now *deprecated*. It was previously used to facilitate interoperability with Artix applications deployed on the z/OS platform. If you have any legacy configuration that uses `SSL_V2V3`, you should replace it with the following combination of settings:

```
policies:iiop_tls:mechanism_policy:protocol_version = ["SSL_V3",
"TLS_V1"];
policies:iiop_tls:mechanism_policy:accept_v2_hellos = "true";
```

---

## server\_address\_mode\_policy:local\_domain

(Java only) When this policy is set, the `iiop_tls` plug-in reads this policy's value instead of the

`policies:iiop:server_address_mode_policy:local_domain` policy's value.

---

## server\_address\_mode\_policy:local\_hostname

(Java only) When this policy is set, the `iiop_tls` plug-in reads this policy's value instead of the

`policies:iiop:server_address_mode_policy:local_hostname` policy's value.

`server_address_mode_policy:local_hostname` specifies the hostname advertised by the locator daemon, and listened on by server-side IIOP.

Some machines have multiple hostnames or IP addresses (for example, those using multiple DNS aliases or multiple network cards). These machines are often termed *multi-homed hosts*. The `local_hostname` variable supports these type of machines by enabling you to explicitly specify the host that servers listen on and publish in their IORs.

For example, if you have a machine with two network addresses (207.45.52.34 and 207.45.52.35), you can explicitly set this variable to either address:

```
policies:iiop:server_address_mode_policy:local_hostname =  
  "207.45.52.34";
```

By default, the `local_hostname` variable is unspecified. Servers use the default hostname configured for the machine with the Orbix configuration tool.

---

## server\_address\_mode\_policy:port\_range

(Java only) When this policy is set, the `iiop_tls` plug-in reads this policy's value instead of the

`policies:iiop:server_address_mode_policy:port_range` policy's value.

`server_address_mode_policy:port_range` specifies the range of ports that a server uses when there is no well-known addressing policy specified for the port.

---

## server\_address\_mode\_policy:publish\_hostname

When this policy is set, the `iiop_tls` plug-in reads this policy's value instead of the

`policies:iiop:server_address_mode_policy:publish_hostname` policy's value.

`server_address_mode_policy:publish_hostname` specifies whether IIOp exports hostnames or IP addresses in published profiles. Defaults to `false` (exports IP addresses, and does not export hostnames). To use hostnames in object references, set this variable to `true`, as in the following file-based configuration entry:

```
policies:iiop:server_address_mode_policy:publish_hostname=true
```

The following `itadmin` command is equivalent:

```
itadmin variable create -type bool -value true
policies:iiop:server_address_mode_policy:publish_hostname
```

---

## server\_version\_policy

When this policy is set, the `iiop_tls` plug-in reads this policy's value instead of the `policies:iiop:server_version_policy` policy's value.

`server_version_policy` specifies the GIOP version published in IIOp profiles. This variable takes a value of either `1.1` or `1.2`. Orbix servers do not publish IIOp 1.0 profiles. The default value is `1.2`.

---

## session\_caching\_policy

This policy overrides `policies:session_caching_policy` for the `iiop_tls` plugin.

---

## target\_secure\_invocation\_policy:requires

This policy overrides

`policies:target_secure_invocation_policy:requires` for the `iiop_tls` plugin.

Specifies the minimum level of security required by a server. The value of this variable is specified as a list of association options—see the *Artix Security Guide* for more details about association options.

In accordance with CORBA security, this policy cannot be downgraded programmatically by the application.

---

## target\_secure\_invocation\_policy:supports

This policy overrides

`policies:target_secure_invocation_policy:supports` for the `iiop_tls` plugin.

Specifies the maximum level of security supported by a server. The value of this variable is specified as a list of association options—see the *Artix Security Guide* for more details about association options.

This policy can be upgraded programmatically using either the `QOP` or the `EstablishTrust` policies.

---

## tcp\_options\_policy:no\_delay

When this policy is set, the `iiop_tls` plug-in reads this policy's value instead of the `policies:iiop:tcp_options_policy:no_delay` policy's value.

`tcp_options_policy:no_delay` specifies whether the `TCP_NODELAY` option should be set on connections. Defaults to `false`.

---

## tcp\_options\_policy:recv\_buffer\_size

When this policy is set, the `iiop_tls` plug-in reads this policy's value instead of the `policies:iop:tcp_options_policy:recv_buffer_size` policy's value.

`tcp_options_policy:recv_buffer_size` specifies the size of the TCP receive buffer. This variable can only be set to 0, which corresponds to using the default size defined by the operating system.

---

## tcp\_options\_policy:send\_buffer\_size

When this policy is set, the `iiop_tls` plug-in reads this policy's value instead of the `policies:iop:tcp_options_policy:send_buffer_size` policy's value.

`tcp_options_policy:send_buffer_size` specifies the size of the TCP send buffer. This variable can only be set to 0, which corresponds to using the default size defined by the operating system.

---

## trusted\_ca\_list\_policy

This policy overrides the `policies:trusted_ca_list_policy` for the `iiop_tls` plugin.

Contains a list of filenames (or a single filename), each of which contains a concatenated list of CA certificates in PEM format. The aggregate of the CAs in all of the listed files is the set of trusted CAs.

For example, you might specify two files containing CA lists as follows:

```
policies:trusted_ca_list_policy =  
    ["ASPInstallDir/asp/6.0/etc/tls/x509/ca/ca_list1.pem",  
     "ASPInstallDir/asp/6.0/etc/tls/x509/ca/ca_list_extra.pem"] ;
```

The purpose of having more than one file containing a CA list is for administrative convenience. It enables you to group CAs into different lists and to select a particular set of CAs for a security domain by choosing the appropriate CA lists.

## policies:security\_server

The `policies:security_server` namespace contains the following variables:

- [client\\_certificate\\_constraints](#)

### client\_certificate\_constraints

Restricts access to the Artix security server, allowing only clients that match the specified certificate constraints to open a connection to the security service. For details of how to specify certificate constraints, see [“Applying Constraints to Certificates” on page 401](#).

For example, by inserting the following setting into the security service’s configuration scope in the Artix configuration file, you can allow access by clients presenting the `administrator.p12` and `iona_utilities.p12` certificates (demonstration certificates).

```
# Allow access by demonstration client certificates.
# WARNING: These settings are NOT secure and must be customized
#           before deploying in a real system.
#
policies:security_server:client_certificate_constraints =
["C=US,ST=Massachusetts,O=ABigBank*,CN=Orbix2000 IONA
 Services (demo cert), OU=Demonstration Section -- no warranty
 --", "C=US,ST=Massachusetts,O=ABigBank*,CN=Abigbank Accounts
 Server*", "C=US,ST=Massachusetts,O=ABigBank*,CN=Iona
 utilities - demo purposes"];
```

The effect of setting this configuration variable is slightly different to the effect of setting `policies:iioptls:certificate_constraints_policy`. Whereas `policies:iioptls:certificate_constraints_policy` affects *all* services deployed in the current process, the `policies:security_server:client_certificate_constraints` variable affects only the Artix security service. This distinction is significant when the login server is deployed into the same process as the security server. In this case, you would typically want to configure the login server such that it does *not* require clients to present an X.509 certificate (this is the default), while the security server *does* require clients to present an X.509 certificate.



This configuration variable must be set in the security server's configuration scope, otherwise the security server will not start.

---

# principal\_sponsor

The `principal_sponsor` namespace stores configuration information to be used when obtaining credentials. The CORBA binding provides an implementation of a principal sponsor that creates credentials for applications automatically.

Use of the `PrincipalSponsor` is disabled by default and can only be enabled through configuration.

The `PrincipalSponsor` represents an entry point into the secure system. It must be activated and authenticate the user, before any application-specific logic executes. This allows unmodified, security-unaware applications to have `Credentials` established transparently, prior to making invocations.

---

## In this section

The following variables are in this namespace:

- `use_principal_sponsor`
  - `auth_method_id`
  - `auth_method_data`
  - `callback_handler:ClassName`
  - `login_attempts`
- 

## use\_principal\_sponsor

`use_principal_sponsor` specifies whether an attempt is made to obtain credentials automatically. Defaults to `false`. If set to `true`, the following `principal_sponsor` variables must contain data in order for anything to actually happen.

## auth\_method\_id

`auth_method_id` specifies the authentication method to be used. The following authentication methods are available:

<code>pkcs12_file</code>	The authentication method uses a PKCS#12 file.
<code>pkcs11</code>	Java only. The authentication data is provided by a smart card.
<code>security_label</code>	Windows and Schannel only. The authentication data is specified by supplying the common name (CN) from an application certificate's subject DN.

For example, you can select the `pkcs12_file` authentication method as follows:

```
principal_sponsor:auth_method_id = "pkcs12_file";
```

## auth\_method\_data

`auth_method_data` is a string array containing information to be interpreted by the authentication method represented by the `auth_method_id`.

For the `pkcs12_file` authentication method, the following authentication data can be provided in `auth_method_data`:

<code>filename</code>	A PKCS#12 file that contains a certificate chain and private key— <i>required</i> .
<code>password</code>	A password for the private key— <i>optional</i> .  It is bad practice to supply the password from configuration for deployed systems. If the password is not supplied, the user is prompted for it.
<code>password_file</code>	The name of a file containing the password for the private key— <i>optional</i> .  This option is not recommended for deployed systems.

For the `pkcs11` (smart card) authentication method, the following authentication data can be provided in `auth_method_data`:

<code>provider</code>	A name that identifies the underlying PKCS #11 toolkit used by Orbix to communicate with the smart card.  The toolkit currently used by Orbix has the provider name <code>dkck132.dll</code> (from Baltimore).
<code>slot</code>	The number of a particular slot on the smart card (for example, 0) containing the user's credentials.
<code>pin</code>	A PIN to gain access to the smart card— <i>optional</i> .  It is bad practice to supply the PIN from configuration for deployed systems. If the PIN is not supplied, the user is prompted for it.

For the `security_label` authentication method on Windows, the following authentication data can be provided in `auth_method_data`:

<code>label</code>	(Windows and Schannel only.) The common name (CN) from an application certificate's subject DN
--------------------	------------------------------------------------------------------------------------------------

For example, to configure an application on Windows to use a certificate, `bob.p12`, whose private key is encrypted with the `bobpass` password, set the `auth_method_data` as follows:

```
principal_sponsor:auth_method_data =
["filename=c:\users\bob\bob.p12", "password=bobpass"];
```

The following points apply to Java implementations:

- If the file specified by `filename=` is not found, it is searched for on the classpath.
- The file specified by `filename=` can be supplied with a URL instead of an absolute file location.
- The mechanism for prompting for the password if the password is supplied through `password=` can be replaced with a custom mechanism, as demonstrated by the `login` demo.

- There are two extra configuration variables available as part of the `principal_sponsor` namespace, namely `principal_sponsor:callback_handler` and `principal_sponsor:login_attempts`. These are described below.
  - These Java-specific features are available subject to change in future releases; any changes that can arise probably come from customer feedback on this area.
- 

### **callback\_handler:ClassName**

`callback_handler:ClassName` specifies the class name of an interface that implements the interface `com.ionacorba.tls.auth.CallbackHandler`. This variable is only used for Java clients.

---

### **login\_attempts**

`login_attempts` specifies how many times a user is prompted for authentication data (usually a password). It applies for both internal and custom `CallbackHandlers`; if a `CallbackHandler` is supplied, it is invoked upon up to `login_attempts` times as long as the `PrincipalAuthenticator` returns `SecAuthFailure`. This variable is only used by Java clients.

---

## principal\_sponsor:csi

The `principal_sponsor:csi` namespace stores configuration information to be used when obtaining CSI (Common Secure Interoperability) credentials. It includes the following:

- `use_existing_credentials`
- `use_principal_sponsor`
- `auth_method_data`
- `auth_method_id`

---

### use\_existing\_credentials

A boolean value that specifies whether ORBs that share credentials can also share CSI credentials. If `true`, any CSI credentials loaded by one credential-sharing ORB can be used by other credential-sharing ORBs loaded after it; if `false`, CSI credentials are not shared.

This variable has no effect, unless the `plugins:security:share_credentials_across_orbs` variable is also `true`. Default is `false`.

---

### use\_principal\_sponsor

`use_principal_sponsor` is a boolean value that switches the CSI principal sponsor on or off.

If set to `true`, the CSI principal sponsor is enabled; if `false`, the CSI principal sponsor is disabled and the remaining `principal_sponsor:csi` variables are ignored. Defaults to `false`.

## auth\_method\_data

`auth_method_data` is a string array containing information to be interpreted by the authentication method represented by the `auth_method_id`.

For the GSSUPMech authentication method, the following authentication data can be provided in `auth_method_data`:

<code>username</code>	The username for CSIV2 authorization. This is optional. Authentication of CSIV2 usernames and passwords is performed on the server side. The administration of usernames depends on the particular security mechanism that is plugged into the server side see <a href="#">auth_over_transport:authentication_service</a> .
<code>password</code>	The password associated with username. This is optional. It is bad practice to supply the password from configuration for deployed systems. If the password is not supplied, the user is prompted for it.
<code>domain</code>	The CSIV2 authentication domain in which the username/password pair is authenticated.  When the client is about to open a new connection, this domain name is compared with the domain name embedded in the relevant IOR (see <a href="#">policies:csi:auth_over_transport:server_domain_name</a> ). The domain names must match.  <b>Note:</b> If <code>domain</code> is an empty string, it matches any target domain. That is, an empty domain string is equivalent to a wildcard.

If any of the preceding data are omitted, the user is prompted to enter authentication data when the application starts up.

For example, to log on to a CSIV2 application as the `administrator` user in the `US-SantaClara` domain:

```
principal_sponsor:csi:auth_method_data =
    ["username=administrator", "domain=US-SantaClara"];
```

When the application is started, the user is prompted for the administrator password.

**Note:** It is currently not possible to customize the login prompt associated with the CSIv2 principal sponsor. As an alternative, you could implement your own login GUI by programming and pass the user input directly to the principal authenticator.

---

## auth\_method\_id

`auth_method_id` specifies a string that selects the authentication method to be used by the CSI application. The following authentication method is available:

GSSUPMech	The Generic Security Service Username/Password (GSSUP) mechanism.
-----------	-------------------------------------------------------------------

For example, you can select the GSSUPMech authentication method as follows:

```
principal_sponsor:csi:auth_method_id = "GSSUPMech";
```



---

# principal\_sponsor:https

The `principal_sponsor:https` namespace provides configuration variables that enable you to specify the *own credentials* used with the HTTPS transport. The variables in the `principal_sponsor:https` namespace (which are specific to the HTTPS protocol) have precedence over the analogous variables in the `principal_sponsor` namespace.

Use of the `PrincipalSponsor` is disabled by default and can only be enabled through configuration.

The `PrincipalSponsor` represents an entry point into the secure system. It must be activated and authenticate the user, before any application-specific logic executes. This allows unmodified, security-unaware applications to have `Credentials` established transparently, prior to making invocations.

---

## In this section

The following variables are in this namespace:

- `use_principal_sponsor`
- `auth_method_id`
- `auth_method_data`

---

## use\_principal\_sponsor

`use_principal_sponsor` specifies whether an attempt is made to obtain credentials automatically. Defaults to `false`. If set to `true`, the following `principal_sponsor:https` variables must contain data in order for anything to actually happen:

- `auth_method_id`
- `auth_method_data`

---

## auth\_method\_id

`auth_method_id` specifies the authentication method to be used. The following authentication methods are available:

`pkcs12_file`      The authentication method uses a PKCS#12 file

For example, you can select the `pkcs12_file` authentication method as follows:

```
principal_sponsor:auth_method_id = "pkcs12_file";
```

---

## auth\_method\_data

`auth_method_data` is a string array containing information to be interpreted by the authentication method represented by the `auth_method_id`.

For the `pkcs12_file` authentication method, the following authentication data can be provided in `auth_method_data`:

<code>filename</code>	A PKCS#12 file that contains a certificate chain and private key— <i>required</i> .
<code>password</code>	A password for the private key— <i>optional</i> . It is bad practice to supply the password from configuration for deployed systems. If the password is not supplied, the user is prompted for it.
<code>password_file</code>	The name of a file containing the password for the private key— <i>optional</i> . This option is not recommended for deployed systems.

For example, to configure an application on Windows to use a certificate, `bob.p12`, whose private key is encrypted with the `bobpass` password, set the `auth_method_data` as follows:

```
principal_sponsor:auth_method_data =
["filename=c:\users\bob\bob.p12", "password=bobpass"];
```

# iSF Configuration

*This appendix provides details of how to configure the Artix security server.*

## **In this appendix**

---

This appendix contains the following sections:

<a href="#">Properties File Syntax</a>	<a href="#">page 486</a>
<a href="#">iSF Properties File</a>	<a href="#">page 487</a>
<a href="#">Cluster Properties File</a>	<a href="#">page 510</a>
<a href="#">log4j Properties File</a>	<a href="#">page 513</a>

---

# Properties File Syntax

---

## Overview

The Artix security service uses standard Java property files for its configuration. Some aspects of the Java properties file syntax are summarized here for your convenience.

---

## Property definitions

A property is defined with the following syntax:

```
<PropertyName>=<PropertyValue>
```

The `<PropertyName>` is a compound identifier, with each component delimited by the `.` (period) character. For example, `is2.current.server.id`. The `<PropertyValue>` is an arbitrary string, including all of the characters up to the end of the line (embedded spaces are allowed).

---

## Specifying full pathnames

When setting a property equal to a filename, you normally specify a full pathname, as follows:

### UNIX

```
/home/data/securityInfo.xml
```

### Windows

```
D:/iona/securityInfo.xml
```

or, if using the backslash as a delimiter, it must be escaped as follows:

```
D:\\iona\\securityInfo.xml
```

---

## Specifying relative pathnames

If you specify a relative pathname when setting a property, the root directory for this path must be added to the Artix security service's classpath. For example, if you specify a relative pathname as follows:

### UNIX

```
securityInfo.xml
```

The security service's classpath must include the file's parent directory:

```
CLASSPATH = /home/data/:<rest_of_classpath>
```

---

# iSF Properties File

---

## Overview

An iSF properties file is used to store the properties that configure a specific Artix security service instance. Generally, every Artix security service instance should have its own iSF properties file. This section provides descriptions of all the properties that can be specified in an iSF properties file.

## File location

The default location of the iSF properties file is the following:

```
ArtixInstallDir/artix/Version/bin/is2.properties
```

In general, the iSF properties file location is specified in the Artix configuration by setting the `is2.properties` property in the `plugins:java_server:system_properties` property list.

For example, on UNIX the security server's property list is normally initialized in the `iona_services.security` configuration scope as follows:

```
# Artix configuration file
...
iona_services {
  ...
  security {
    ...
    plugins:java_server:system_properties =
["org.omg.CORBA.ORBClass=com.iona.corba.art.artimpl.ORBImpl",
"org.omg.CORBA.ORBSingletonClass=com.iona.corba.art.artimpl.ORBSingleton",
"is2.properties=ArtixInstallDir/artix/2.0/bin/is2.properties"
];
    ...
  };
};
```

---

**List of properties**

The following properties can be specified in the iSF properties file:

---

**check.kdc.running**

A boolean property that specifies whether or not the Artix security service should check whether the Kerberos KDC server is running. Default is `false`.

---

**check.kdc.principal**

(Used in combination with the `check.kdc.running` property.) Specifies the dummy KDC principal that is used for connecting to the KDC server, in order to check whether it is running or not.

---

**com.ionas.isp.adapters**

Specifies the iSF adapter type to be loaded by the Artix security service at runtime. Choosing a particular adapter type is equivalent to choosing an Artix security domain. Currently, you can specify one of the following adapter types:

- `file`
- `LDAP`
- `krb5`

For example, you can select the LDAP adapter as follows:

```
com.ionas.isp.adapters=LDAP
```

---

**com.ionas.isp.adapter.file.class**

Specifies the Java class that implements the file adapter.

For example, the default implementation of the file adapter provided with Artix is selected as follows:

```
com.ionas.isp.adapter.file.class=com.ionas.security.is2adapter.file.FileAuthAdapter
```

---

## com.iona.isp.adapter.file.param.filename

Specifies the name and location of a file that is used by the file adapter to store user authentication data.

For example, you can specify the file, `C:/is2_config/security_info.xml`, as follows:

```
com.iona.isp.adapter.file.param.filename=C:/is2_config/security_info.xml
```

---

## com.iona.isp.adapter.file.param.userIDInCert

If an X.509 certificate is presented to the Artix security service for authentication, this property specifies which field from the certificate's subject DN is taken to be the user name.

The `userIDInCert` property can be set to any valid *attribute type*, where the attribute type identifies a field in a Distinguished Name (DN). See [“Attribute types” on page 520](#) for a partial list.

For example, to specify that the user name is taken from the Common Name (CN) from the certificate's subject DN, set the property as follows:

```
com.iona.isp.adapter.file.param.userIDInCert=CN
```

---

## com.iona.isp.adapter.file.params

*Obsolete.* This property was needed by earlier versions of the Artix security service, but is now ignored.

---

## com.iona.isp.adapter.LDAP.class

Specifies the Java class that implements the LDAP adapter.

For example, the default implementation of the LDAP adapter provided with Artix is selected as follows:

```
com.iona.isp.adapter.LDAP.class=com.iona.security.is2adapter.ldap.LdapAdapter
```

---

## com.iona.isp.adapter.LDAP.param.CacheSize

Specifies the maximum LDAP cache size in units of bytes. This maximum applies to the *total* LDAP cache size, including all LDAP connections opened by this Artix security service instance.

Internally, the Artix security service uses a third-party toolkit (currently the *iPlanet SDK*) to communicate with an LDAP server. The cache referred to here is one that is maintained by the LDAP third-party toolkit. Data retrieved from the LDAP server is temporarily stored in the cache in order to optimize subsequent queries.

For example, you can specify a cache size of 1000 as follows:

```
com.iona.isp.adapter.LDAP.param.CacheSize=1000
```

---

## com.iona.isp.adapter.LDAP.param.CacheTimeToLive

Specifies the LDAP cache time to-live in units of seconds. For example, you can specify a cache time to-live of one minute as follows:

```
com.iona.isp.adapter.LDAP.param.CacheTimeToLive=60
```

---

## com.iona.isp.adapter.LDAP.param.GroupBaseDN

Specifies the base DN of the tree in the LDAP directory that stores user groups.

For example, you could use the RDN sequence, `DC=iona,DC=com`, as a base DN by setting this property as follows:

```
com.iona.isp.adapter.LDAP.param.GroupBaseDN=dc=iona,dc=com
```

**Note:** The order of the RDNs is significant. The order should be based on the LDAP schema configuration.



---

## com.iona.isp.adapter.LDAP.param.GroupNameAttr

Specifies the attribute type whose corresponding attribute value gives the name of the user group. The default is `CN`.

For example, you can use the common name, `CN`, attribute type to store the user group's name by setting this property as follows:

```
com.iona.isp.adapter.LDAP.param.GroupNameAttr=cn
```

---

## com.iona.isp.adapter.LDAP.param.GroupObjectClass

Specifies the object class that applies to user group entries in the LDAP directory structure. An object class defines the required and allowed attributes of an entry. The default is `groupOfUniqueNames`.

For example, to specify that all user group entries belong to the `groupOfUniqueNames` object class:

```
com.iona.isp.adapter.LDAP.param.GroupObjectClass=groupofuniquenames
```

---

## com.iona.isp.adapter.LDAP.param.GroupSearchScope

Specifies the group search scope. The search scope is the starting point of a search and the depth from the base DN to which the search should occur. This property can be set to one of the following values:

- `BASE`—Search a single entry (the base object).
- `ONE`—Search all entries immediately below the base DN.
- `SUB`—Search all entries from a whole subtree of entries.

Default is `SUB`.

For example:

```
com.iona.isp.adapter.LDAP.param.GroupSearchScope=SUB
```

---

### **com.iona.isp.adapter.LDAP.param.host.<cluster\_index>**

For the <cluster\_index> LDAP server replica, specifies the IP hostname where the LDAP server is running. The <cluster\_index> is 1 for the primary server, 2 for the first failover replica, and so on.

For example, you could specify that the primary LDAP server is running on host 10.81.1.100 as follows:

```
com.iona.isp.adapter.LDAP.param.host.1=10.81.1.100
```

---

### **com.iona.isp.adapter.LDAP.param.MaxConnectionPoolSize**

Specifies the maximum LDAP connection pool size for the Artix security service (a strictly positive integer). The maximum connection pool size is the maximum number of LDAP connections that would be opened and cached by the Artix security service. The default is 1.

For example, to limit the Artix security service to open a maximum of 50 LDAP connections at a time:

```
com.iona.isp.adapter.LDAP.param.MaxConnectionPoolSize=50
```

---

### **com.iona.isp.adapter.LDAP.param.MemberDNAttr**

Specifies which LDAP attribute is used to retrieve group members. The LDAP adapter uses the `MemberDNAttr` property to construct a query to find out which groups a user belongs to.

The list of the user's groups is needed to determine the complete set of roles assigned to the user. The LDAP adapter determines the complete set of roles assigned to a user as follows:

1. The adapter retrieves the roles assigned directly to the user.
2. The adapter finds out which groups the user belongs to, and retrieves all the roles assigned to those groups.

Default is `uniqueMember`.

For example, you can select the `uniqueMember` attribute as follows:

```
com.iona.isp.adapter.LDAP.param.MemberDNAttr=uniqueMember
```

---

## **com.iona.isp.adapter.LDAP.param.MemberFilter**

Specifies how to search for members in a group. The value specified for this property must be an LDAP search filter (can be a custom filter).

---

## **com.iona.isp.adapter.LDAP.param.MinConnectionPoolSize**

Specifies the minimum LDAP connection pool size for the Artix security service. The minimum connection pool size specifies the number of LDAP connections that are opened during initialization of the Artix security service. The default is 1.

For example, to specify a minimum of 10 LDAP connections at a time:

```
com.iona.isp.adapter.LDAP.param.MinConnectionPoolSize=10
```

---

## **com.iona.isp.adapter.LDAP.param.port.<cluster\_index>**

For the <cluster\_index> LDAP server replica, specifies the IP port where the LDAP server is listening. The <cluster\_index> is 1 for the primary server, 2 for the first failover replica, and so on. The default is 389.

For example, you could specify that the primary LDAP server is listening on port 636 as follows:

```
com.iona.isp.adapter.LDAP.param.port.1=636
```

---

## **com.iona.isp.adapter.LDAP.param.PrincipalUserDN.<cluster\_index>**

For the <cluster\_index> LDAP server replica, specifies the username that is used to login to the LDAP server (in distinguished name format). This property need only be set if the LDAP server is configured to require username/password authentication.

No default.

---

### **com.iona.isp.adapter.LDAP.param.PrincipalUserPassword.<cluster\_index>**

For the <cluster\_index> LDAP server replica, specifies the password that is used to login to the LDAP server. This property need only be set if the LDAP server is configured to require username/password authentication.

No default.

**WARNING:** Because the password is stored in plaintext, you must ensure that the `is2.properties` file is readable and writable only by users with administrator privileges.

---

### **com.iona.isp.adapter.LDAP.param.RetrieveAuthInfo**

Specifies whether or not the Artix security service retrieves authorization information from the LDAP server. This property selects one of the following alternatives:

- `yes`—the Artix security service retrieves authorization information from the LDAP server.
- `no`—the Artix security service retrieves authorization information from the iS2 authorization manager..

Default is `no`.

For example, to use the LDAP server's authorization information:

```
com.iona.isp.adapter.LDAP.param.RetrieveAuthInfo=yes
```

---

### **com.iona.isp.adapter.LDAP.param.RoleNameAttr**

Specifies the attribute type that the LDAP server uses to store the role name. The default is `CN`.

For example, you can specify the common name, `CN`, attribute type as follows:

```
com.iona.isp.adapter.LDAP.param.RoleNameAttr=cn
```

---

**com.iona.isp.adapter.LDAP.param.SSLCACertDir.***<cluster\_index>*

For the *<cluster\_index>* LDAP server replica, specifies the directory name for trusted CA certificates. All certificate files in this directory are loaded and set as trusted CA certificates, for the purpose of opening an SSL connection to the LDAP server. The CA certificates can either be in DER-encoded X.509 format or in PEM-encoded X.509 format.

No default.

For example, to specify that the primary LDAP server uses the `d:/certs/test` directory to store CA certificates:

```
com.iona.isp.adapter.LDAP.param.SSLCACertDir.1=d:/certs/test
```

---

**com.iona.isp.adapter.LDAP.param.SSLClientCertFile.***<cluster\_index>*

Specifies the client certificate file that is used to identify the Artix security service to the *<cluster\_index>* LDAP server replica. This property is needed only if the LDAP server requires SSL/TLS mutual authentication. The certificate must be in PKCS#12 format.

No default.

---

**com.iona.isp.adapter.LDAP.param.SSLClientCertPassword.***<cluster\_index>*

Specifies the password for the client certificate that identifies the Artix security service to the *<cluster\_index>* LDAP server replica. This property is needed only if the LDAP server requires SSL/TLS mutual authentication.

**WARNING:** Because the password is stored in plaintext, you must ensure that the `is2.properties` file is readable and writable only by users with administrator privileges.

---

**com.iona.isp.adapter.LDAP.param.SSLEnabled.***<cluster\_index>*

Enables SSL/TLS security for the connection between the Artix security service and the *<cluster\_index>* LDAP server replica. The possible values are `yes` or `no`. Default is `no`.

For example, to enable an SSL/TLS connection to the primary LDAP server:

```
com.iona.isp.adapter.LDAP.param.SSLEnabled.1=yes
```

---

## **com.iona.isp.adapter.LDAP.param.UseGroupAsRole**

Specifies whether a user's groups should be treated as roles. The following alternatives are available:

- `yes`—each group name is interpreted as a role name.
- `no`—for each of the user's groups, retrieve all roles assigned to the group.

This option is useful for some older versions of LDAP, such as iPlanet 4.0, that do not have the role concept.

Default is `no`.

For example:

```
com.iona.isp.adapter.LDAP.param.UseGroupAsRole=no
```

---

## **com.iona.isp.adapter.LDAP.param.UserBaseDN**

Specifies the base DN (an ordered sequence of RDNs) of the tree in the LDAP directory that stores user object class instances.

For example, you could use the RDN sequence, `DC=iona,DC=com`, as a base DN by setting this property as follows:

```
com.iona.isp.adapter.LDAP.param.UserBaseDN=dc=iona,dc=com
```

---

## **com.iona.isp.adapter.LDAP.param.UserCertAttrName**

Specifies the attribute type that stores a user certificate. The default is `userCertificate`.

For example, you can explicitly specify the attribute type for storing user certificates to be `userCertificate` as follows:

```
com.iona.isp.adapter.LDAP.param.UserCertAttrName=userCertificate
```

---

## **com.iona.isp.adapter.LDAP.param.UserNameAttr=uid**

Specifies the attribute type whose corresponding value uniquely identifies the user. This is the attribute used as the user's login ID. The default is `uid`.  
For example:

```
com.iona.isp.adapter.LDAP.param.UserNameAttr=uid
```

---

## **com.iona.isp.adapter.LDAP.param.UserObjectClass**

Specifies the attribute type for the object class that stores users. The default is `organizationalPerson`.  
For example:

```
com.iona.isp.adapter.LDAP.param.UserObjectClass=organizationalPerson
```

---

## **com.iona.isp.adapter.LDAP.param.UserRoleDNAttr**

Specifies the attribute type that stores a user's role DN. The default is `nsRoleDn` (from the Netscape LDAP directory schema).  
For example:

```
com.iona.isp.adapter.LDAP.param.UserRoleDNAttr=nsroledn
```

---

## **com.iona.isp.adapter.LDAP.param.UserSearchFilter**

Custom filter for retrieving users. In the current version, `$(USER_NAME$)` is the only replaceable parameter supported. This parameter would be replaced during runtime by the LDAP adapter with the current User's login ID. This property uses the standard LDAP search filter syntax.

For example:

```
&(uid=$(USER_NAME$))(objectclass=organizationalPerson)
```

---

## com.iona.isp.adapter.LDAP.param.UserSearchScope

Specifies the user search scope. This property can be set to one of the following values:

- `BASE`—Search a single entry (the base object).
- `ONE`—Search all entries immediately below the base DN.
- `SUB`—Search all entries from a whole subtree of entries.

Default is `SUB`.

For example:

```
com.iona.isp.adapter.LDAP.param.UserSearchScope=SUB
```

---

## com.iona.isp.adapter.LDAP.param.version

Specifies the LDAP protocol version that the Artix security service uses to communicate with LDAP servers. The only supported version is 3 (for LDAP v3, <http://www.ietf.org/rfc/rfc2251.txt>). The default is 3.

For example, to select the LDAP protocol version 3:

```
com.iona.isp.adapter.LDAP.param.version=3
```

---

## com.iona.isp.adapter.LDAP.params

*Obsolete.* This property was needed by earlier versions of the Artix security service, but is now ignored.

---

## com.iona.isp.adapter.krb5.class

Specifies the Java class that implements the Kerberos adapter.

For example, the default implementation of the Kerberos adapter provided with Artix is selected as follows:

```
com.iona.isp.adapter.krb5.class=com.iona.security.is2adapter.krb5.IS2KerberosAdapter
```



---

## com.iona.isp.adapter.krb5.param.ConnectTimeout.1

Specifies the time-out interval for the connection to the Active Directory Server.

---

## com.iona.isp.adapter.krb5.param.GroupBaseDN

Specifies the base DN of the tree in the LDAP directory that stores user groups.

For example, you could use the RDN sequence, `DC=iona,DC=com`, as a base DN by setting this property as follows:

```
com.iona.isp.adapter.krb5.param.GroupBaseDN=dc=iona,dc=com
```

**Note:** The order of the RDNs is significant. The order should be based on the LDAP schema configuration.

---

## com.iona.isp.adapter.krb5.param.GroupNameAttr

Specifies the attribute type whose corresponding attribute value gives the name of the user group. The default is `CN`.

For example, you can use the common name, `CN`, attribute type to store the user group's name by setting this property as follows:

```
com.iona.isp.adapter.krb5.param.GroupNameAttr=cn
```

---

## com.iona.isp.adapter.krb5.param.GroupObjectClass

Specifies the object class that applies to user group entries in the LDAP directory structure. An object class defines the required and allowed attributes of an entry. The default is `groupOfUniqueNames`.

For example, to specify that all user group entries belong to the `groupOfWriters` object class:

```
com.iona.isp.adapter.krb5.param.GroupObjectClass=groupOfWriters
```

---

## **com.iona.isp.adapter.krb5.param.GroupSearchScope**

Specifies the group search scope. The search scope is the starting point of a search and the depth from the base DN to which the search should occur. This property can be set to one of the following values:

- `BASE`—Search a single entry (the base object).
- `ONE`—Search all entries immediately below the base DN.
- `SUB`—Search all entries from a whole subtree of entries.

Default is `SUB`.

For example, to search just the entries immediately below the base DN you would use the following:

```
com.iona.isp.adapter.krb5.param.GroupSearchScope=ONE
```

---

## **com.iona.isp.adapter.krb5.param.host.1**

Specifies the server name or IP address of the Active Directory Server used to retrieve a user's group information.

---

## **com.iona.isp.adapter.krb5.param.java.security.auth.login.config**

Specifies the JAAS login module configuration file. For example, if your JAAS login module configuration file is `jaas.config`, your Artix security service configuration would contain the following:

```
com.iona.isp.adapter.krb5.param.java.security.auth.login.config=jaas.conf
```

---

## **com.iona.isp.adapter.krb5.param.java.security.krb5.kdc**

Specifies the server name or IP address of the Kerberos KDC server.

---

## **com.iona.isp.adapter.krb5.param.java.security.krb5.realm**

Specifies the Kerberos Realm name.

For example, to specify that the Kerberos Realm is `is2.iona.com` would require an entry similar to:

```
com.iona.isp.adapter.krb5.param.java.security.krb5.realm=is2.iona.com
```

---

## **com.iona.isp.adapter.krb5.param.javax.security.auth.useSubjectCredsOnly**

This is a JAAS login module property that must be set to `false` when using Artix.

---

## **com.iona.isp.adapter.krb5.param.MaxConnectionPoolSize**

Specifies the maximum LDAP connection pool size for the Kerberos adapter (a strictly positive integer). The maximum connection pool size is the maximum number of LDAP connections that would be opened and cached by the Kerberos adapter. The default is 1.

For example, to limit the Kerberos adapter to open a maximum of 50 LDAP connections at a time:

```
com.iona.isp.adapter.krb5.param.MaxConnectionPoolSize=50
```

---

## **com.iona.isp.adapter.krb5.params.MemberDNAttr**

Specifies which LDAP attribute is used to retrieve group members. The Kerberos adapter uses the `MemberDNAttr` property to construct a query to find out which groups a user belongs to.

The list of the user's groups is needed to determine the complete set of roles assigned to the user. The LDAP adapter determines the complete set of roles assigned to a user as follows:

1. The adapter retrieves the roles assigned directly to the user.
2. The adapter finds out which groups the user belongs to, and retrieves all the roles assigned to those groups.

Default is `uniqueMember`.

For example, you can select the `uniqueMember` attribute as follows:

```
com.iona.isp.adapter.krb5.param.MemberDNAttr=uniqueMember
```

---

## **com.iona.isp.adapter.krb5.param.MinConnectionPoolSize**

Specifies the minimum LDAP connection pool size for the Kerberos adapter. The minimum connection pool size specifies the number of LDAP connections that are opened during initialization of the Kerberos adapter. The default is 1.

For example, to specify a minimum of 10 LDAP connections at a time:

```
com.iona.isp.adapter.krb5.param.MinConnectionPoolSize=10
```

---

## **com.iona.isp.adapter.krb5.param.port.1**

Specifies the port on which the Active Directory Server can be contacted.

---

## **com.iona.adapter.krb5.param.PrincipleUserDN.1**

Specifies the username that is used to login to the Active Directory Server (in distinguished name format). This property need only be set if the Active Directory Server is configured to require username/password authentication.

---

## **com.iona.isp.adapter.krb5.param.PrincipalUserPassword.1**

Specifies the password that is used to login to the Active Directory Server. This property need only be set if the Active Directory Server is configured to require username/password authentication.

**WARNING:** Because the password is stored in plaintext, you must ensure that the `isp2.properties` file is readable and writable only by users with administrator privileges.

---

## **com.iona.isp.adapter.krb5.param.RetrieveAuthInfo**

Specifies if the user's group information needs to be retrieved from the Active Directory Server. Default is `false`.

To instruct the Kerberos adapter to retrieve the user's group information, use the following:

```
com.iona.isp.adapter.krb5.param.RetrieveAuthInfo=true
```

---

## **com.iona.isp.adapter.krb5.param.SSLCACertDir.1**

Specifies the directory name for trusted CA certificates. All certificate files in this directory are loaded and set as trusted CA certificates, for the purpose of opening an SSL connection to the Active Directory Server. The CA certificates can either be in DER-encoded X.509 format or in PEM-encoded X.509 format.

For example, to specify that the Kerberos adapter uses the `d:/certs/test` directory to store CA certificates:

```
com.iona.isp.adapter.krb5.param.SSLCACertDir.1=d:/certs/test
```

---

## **com.iona.isp.adapter.krb5.param.SSLClientCertFile.1**

Specifies the client certificate file that is used to identify the Artix security service to the Active Directory Server. This property is needed only if the Active Directory Server requires SSL/TLS mutual authentication. The certificate must be in PKCS#12 format.

---

## **com.iona.isp.adapter.krb5.param.SSLClientCertPassword.1**

Specifies the password for the client certificate that identifies the Artix security service to the Active Directory Server. This property is needed only if the Active Directory Server requires SSL/TLS mutual authentication.

**WARNING:** Because the password is stored in plaintext, you must ensure that the `is2.properties` file is readable and writable only by users with administrator privileges.

---

## com.iona.isp.adapter.krb5.param.SSLEnabled.1

Specifies if SSL is needed to connect with the Active Directory Server. The default is `no`.

To use SSL when contacting the Active Directory Server use the following:

```
com.iona.isp.adapter.krb5.param.SSLEnabled.1=yes
```

---

## com.iona.isp.adapter.param.UserBaseDN

Specifies the base DN (an ordered sequence of RDNs) of the tree in the active directory that stores user object class instances.

For example, you could use the RDN sequence, `DC=iona,DC=com`, as a base DN by setting this property as follows:

```
com.iona.isp.adapter.krb5.param.UserBaseDN=dc=iona,dc=com
```

---

## com.iona.isp.adapter.krb5.param.UserNameAttr

Specifies the attribute type whose corresponding value uniquely identifies the user. This is the attribute used as the user's login ID. The default is `uid`.

For example:

```
com.iona.isp.adapter.krb5.param.UserNameAttr=uid
```

---

## com.iona.isp.adapter.krb5.param.UserObjectClass

Specifies the attribute type for the object class that stores users. The default is `organizationalPerson`.

For example to set the class to `Person` you would use the following:

```
com.iona.isp.adapter.krb5.param.UserObjectClass=Person
```

---

## com.iona.isp.adapter.krb5.param.version

Specifies the LDAP protocol version that the Kerberos adapter uses to communicate with the Active Directory Server. The only supported version is 3 (for LDAP v3, <http://www.ietf.org/rfc/rfc2251.txt>). The default is 3.

For example, to select the LDAP protocol version 3:

```
com.iona.isp.adapter.krb5.param.version=3
```

---

## com.iona.isp.authz.adapters

Specifies the name of the adapter that is loaded to perform authorization. The adapter name is an arbitrary identifier, *AdapterName*, which is used to construct the names of the properties that configure the adapter—that is, `com.iona.isp.authz.adapter.AdapterName.class` and `com.iona.isp.authz.adapter.AdapterName.param.filelist`. For example:

```
com.iona.isp.authz.adapters=file
com.iona.isp.authz.adapter.file.class=com.iona.security.is2AzAdapter.multifile.MultiFileAzAdapter
com.iona.isp.authz.adapter.file.param.filelist=ACLFileListFile;
```

---

## com.iona.isp.authz.adapter.*AdapterName*.class

Selects the authorization adapter class for the *AdapterName* adapter. The following adapter implementations are provided by Orbix:

- `com.iona.security.is2AzAdapter.multifile.MultiFileAzAdapter`—an authorization adapter that enables you to specify multiple ACL files. It is used in conjunction with the `com.iona.isp.authz.adapter.file.param.filelist` property.

For example:

```
com.iona.isp.authz.adapters = file
com.iona.isp.authz.adapter.file.class=com.iona.security.is2AzAdapter.multifile.MultiFileAzAdapter
```

---

## com.iona.isp.authz.adapter.*AdapterName*.param.filelist

Specifies the absolute pathname of a file containing a list of ACL files for the *AdapterName* adapter. Each line of the specified file has the following format:

```
[ACLKey=]ACLFileName
```

A file name can optionally be preceded by an ACL key and an equals sign, *ACLKey=*, if you want to select the file by ACL key. The ACL file, *ACLFileName*, is specified using an absolute pathname in the local file format.

For example, on Windows you could specify a list of ACL files as follows:

```
U:/orbix_security/etc/acl_files/server_A.xml
U:/orbix_security/etc/acl_files/server_B.xml
U:/orbix_security/etc/acl_files/server_C.xml
```

---

## is2.current.server.id

The server ID is an alphanumeric string (excluding spaces) that specifies the current Orbix security service's ID. The server ID is needed for clustering. When a secure application obtains a single sign-on (SSO) token from this Orbix security service, the server ID is embedded into the SSO token. Subsequently, if the SSO token is passed to a *second* Orbix security service instance, the second Orbix security service recognizes that the SSO token originates from the first Orbix security service and delegates security operations to the first Orbix security service.

The server ID is also used to identify replicas in the `cluster.properties` file.

For example, to assign a server ID of 1 to the current Orbix security service:

```
is2.current.server.id=1
```



---

## is2.cluster.properties.filename

Specifies the file that stores the configuration properties for clustering. For example:

```
is2.cluster.properties.filename=C:/is2_config/cluster.properties
```

---

## is2.replication.required

Enables the replication feature of the Artix security service, which can be used in the context of security service clustering. The possible values are `true` (enabled) and `false` (disabled). When replication is enabled, the security service pushes its cache of SSO data to other servers in the cluster at regular intervals.

Default is `false`.

For example:

```
is2.replication.required=true
```

---

## is2.replication.interval

Specifies the time interval between replication updates to other servers in the security service cluster. The value is specified in units of a second.

Default is 30 seconds.

For example:

```
is2.replication.interval=10
```

---

## is2.replica.selector.classname

If replication is enabled (see `is2.replication.required`), you must set this variable equal to `com.iona.security.replicate.StaticReplicaSelector`.

For example:

```
is2.replica.selector.classname=com.iona.security.replicate.StaticReplicaSelector
```

---

## is2.sso.cache.size

Specifies the maximum cache size (number of user sessions) associated with single sign-on (SSO) feature. The SSO caches user information, including the user's group and role information. If the maximum cache size is reached, the oldest sessions are deleted from the session cache.

No default.

For example:

```
is2.sso.cache.size=1000
```

---

## is2.sso.enabled

Enables the single sign-on (SSO) feature of the Artix security service. The possible values are `yes` (enabled) and `no` (disabled).

Default is `yes`.

For example:

```
is2.sso.enabled=yes
```

---

## is2.sso.remote.token.cached

In a federated scenario, this variable enables caching of token data for tokens that originate from another security service in the federated cluster. When this variable is set to `true`, a security service need contact another security service in the cluster, only when the remote token is authenticated for the first time. For subsequent token authentications, the token data for the remote token can be retrieved from the local cache.

Default is `false`.

---

## is2.sso.session.idle.timeout

Sets the session idle time-out in units of seconds for the single sign-on (SSO) feature of the Artix security service. A zero value implies no time-out.

If a user logs on to the Artix Security Framework (supplying username and password) with SSO enabled, the Artix security service returns an SSO token for the user. The next time the user needs to access a resource, there is no need to log on again because the SSO token can be used instead. However, if no secure operations are performed using the SSO token for the length of time specified in the idle time-out, the SSO token expires and the user must log on again.

Default is 0 (no time-out).

For example:

```
is2.sso.session.idle.timeout=0
```

---

## is2.sso.session.timeout

Sets the absolute session time-out in units of seconds for the single sign-on (SSO) feature of the Artix security service. A zero value implies no time-out.

This is the maximum length of time since the time of the original user login for which an SSO token remains valid. After this time interval elapses, the session expires irrespective of whether the session has been active or idle. The user must then login again.

Default is 0 (no time-out).

For example:

```
is2.sso.session.timeout=0
```

---

## log4j.configuration

Specifies the log4j configuration filename. You can use the properties in this file to customize the level of debugging output from the Artix security service. See also [“log4j Properties File” on page 513](#).

For example:

```
log4j.configuration=d:/temp/myconfig.txt
```

---

# Cluster Properties File

---

## Overview

The cluster properties file is used to store properties common to a group of Artix security service instances that operate as a cluster or federation. This section provides descriptions of all the properties that can be specified in a cluster file.

---

## File location

The location of the cluster properties file is specified by the `is2.cluster.properties.filename` property in the iSF properties file. All of the Artix security service instances in a cluster or federation must share the same cluster properties file.

---

## List of properties

The following properties can be specified in the cluster properties file:

---

### `com.ionasecurity.common.securityInstanceURL.<server_ID>`

Specifies the server URL for the `<server_ID>` Artix security service instance. When single sign-on (SSO) is enabled together with clustering or federation, the Artix security service instances use the specified instance URLs to communicate with each other. By specifying the URL for a particular Artix security service instance, you are instructing the instance to listen for messages at that URL. Because the Artix security service instances share the same cluster file, they can read each other's URLs and open connections to each other.

The connections between Artix security service instances can either be insecure (HTTP) or secure (HTTPS). To enable SSL/TLS security, use the `https:` prefix in each of the instance URLs.

For example, to configure two Artix security service instances to operate in a cluster or federation using *insecure* communications (HTTP):

```
com.ionasecurity.common.securityInstanceURL.1=http://localhost:8080/isp/AuthService
com.ionasecurity.common.securityInstanceURL.2=http://localhost:8081/isp/AuthService
```

Alternatively, to configure two Artix security service instances to operate in a cluster or federation using *secure* communications (HTTPS):

```
com.iona.security.common.securityInstanceURL.1=https://localhost:8080/isp/AuthService
com.iona.security.common.securityInstanceURL.2=https://localhost:8081/isp/AuthService
```

In the secure case, you must also configure the certificate-related cluster properties (described in this section) for each Artix security service instance.

---

### **com.iona.security.common.replicaURL.<server\_ID>**

A comma-separated list of URLs for the other security services to which this service replicates its SSO token data.

---

### **com.iona.security.common.cACertDir.<server\_ID>**

For the <server\_ID> Artix security service instance in a HTTPS cluster or federation, specifies the directory containing trusted CA certificates. The CA certificates can either be in DER-encoded X.509 format or in PEM-encoded X.509 format.

For example, to specify `d:/temp/cert` as the CA certificate directory for the primary Artix security service instance:

```
com.iona.security.common.cACertDir.1=d:/temp/cert
```

---

### **com.iona.security.common.clientCertFileName.<server\_ID>**

For the <server\_ID> Artix security service instance in a HTTPS cluster or federation, specifies the client certificate file that identifies the Artix security service to its peers within a cluster or federation. The certificate must be in PKCS#12 format.

---

### **com.iona.security.common.clientCertPassword.<server\_ID>**

For the <server\_ID> Artix security service instance in a HTTPS cluster or federation, specifies the password for the client certificate that identifies the Artix security service to its peers within a cluster or federation.

**WARNING:** Because the password is stored in plaintext, you must ensure that the `is2.properties` file is readable and writable only by users with administrator privileges.

---

# log4j Properties File

---

## Overview

The log4j properties file configures log4j logging for your Artix security service. This section describes a minimal set of log4j properties that can be used to configure basic logging.

## log4j documentation

For complete log4j documentation, see the following Web page:  
<http://jakarta.apache.org/log4j/docs/documentation.html>

## File location

The location of the log4j properties file is specified by the `log4j.configuration` property in the iSF properties file. For ease of administration, different Artix security service instances can optionally share a common log4j properties file.

## List of properties

To give you some idea of the capabilities of log4j, the following is an incomplete list of properties that can be specified in a log4j properties file:

### log4j.appender.<AppenderHandle>

This property specifies a log4j appender class that directs <AppenderHandle> logging messages to a particular destination. For example, one of the following standard log4j appender classes could be specified:

- `org.apache.log4j.ConsoleAppender`
- `org.apache.log4j.FileAppender`
- `org.apache.log4j.RollingFileAppender`
- `org.apache.log4j.DailyRollingFileAppender`
- `org.apache.log4j.AsyncAppender`
- `org.apache.log4j.WriterAppender`

For example, to log messages to the console screen for the `A1` appender handle:

```
log4j.appender.A1=org.apache.log4j.ConsoleAppender
```

---

## log4j.appender.<AppenderHandle>.layout

This property specifies a log4j layout class that is used to format <AppenderHandle> logging messages. One of the following standard log4j layout classes could be specified:

- org.apache.log4j.PatternLayout
- org.apache.log4j.HTMLLayout
- org.apache.log4j.SimpleLayout
- org.apache.log4j.TTCCLayout

For example, to use the pattern layout class for log messages processed by the A1 appender:

```
log4j.appender.A1.layout=org.apache.log4j.PatternLayout
```

---

## log4j.appender.<AppenderHandle>.layout.ConversionPattern

This property is used only in conjunction with the org.apache.log4j.PatternLayout class (when specified by the log4j.appender.<AppenderHandle>.layout property) to define the format of a log message.

For example, you can specify a basic conversion pattern for the A1 appender as follows:

```
log4j.appender.A1.layout.ConversionPattern=%-4r [%t] %-5p %c %x - %m%n
```

---

## log4j.rootCategory

This property is used to specify the logging level of the root logger and to associate the root logger with one or more appenders. The value of this property is specified as a comma separated list as follows:

```
<LogLevel>, <AppenderHandle01>, <AppenderHandle02>, ...
```

The logging level, <LogLevel>, can have one of the following values:

- DEBUG
- INFO
- WARN
- ERROR



- FATAL

An appender handle is an arbitrary identifier that associates a logger with a particular logging destination.

For example, to select all messages at the `DEBUG` level and direct them to the `A1` appender, you can set the property as follows:

```
log4j.rootCategory=DEBUG, A1
```



# ASN.1 and Distinguished Names

*The OSI Abstract Syntax Notation One (ASN.1) and X.500 Distinguished Names play an important role in the security standards that define X.509 certificates and LDAP directories.*

---

## **In this appendix**

This appendix contains the following section:

<a href="#">ASN.1</a>	<a href="#">page 518</a>
<a href="#">Distinguished Names</a>	<a href="#">page 519</a>

# ASN.1

---

## Overview

The *Abstract Syntax Notation One* (ASN.1) was defined by the OSI standards body in the early 1980s to provide a way of defining data types and structures that is independent of any particular machine hardware or programming language. In many ways, ASN.1 can be considered a forerunner of the OMG's IDL, because both languages are concerned with defining platform-independent data types.

ASN.1 is important, because it is widely used in the definition of standards (for example, SNMP, X.509, and LDAP). In particular, ASN.1 is ubiquitous in the field of security standards—the formal definitions of X.509 certificates and distinguished names are described using ASN.1 syntax. You do not require detailed knowledge of ASN.1 syntax to use these security standards, but you need to be aware that ASN.1 is used for the basic definitions of most security-related data types.

---

## BER

The OSI's Basic Encoding Rules (BER) define how to translate an ASN.1 data type into a sequence of octets (binary representation). The role played by BER with respect to ASN.1 is, therefore, similar to the role played by GIOP with respect to the OMG IDL.

---

## DER

The OSI's Distinguished Encoding Rules (DER) are a specialization of the BER. The DER consists of the BER plus some additional rules to ensure that the encoding is unique (BER encodings are not).

---

## References

You can read more about ASN.1 in the following standards documents:

- ASN.1 is defined in X.208.
- BER is defined in X.209.

---

# Distinguished Names

---

## Overview

Historically, distinguished names (DN) were defined as the primary keys in an X.500 directory structure. In the meantime, however, DNs have come to be used in many other contexts as general purpose identifiers. In the Artix Security Framework, DNs occur in the following contexts:

- X.509 certificates—for example, one of the DNs in a certificate identifies the owner of the certificate (the security principal).
- LDAP—DNs are used to locate objects in an LDAP directory tree.

---

## String representation of DN

Although a DN is formally defined in ASN.1, there is also an LDAP standard that defines a UTF-8 string representation of a DN (see RFC 2253). The string representation provides a convenient basis for describing the structure of a DN.

**Note:** The string representation of a DN does *not* provide a unique representation of DER-encoded DN. Hence, a DN that is converted from string format back to DER format does not always recover the original DER encoding.

---

## DN string example

The following string is a typical example of a DN:

```
C=US,O=IONA Technologies,OU=Engineering,CN=A. N. Other
```

---

## Structure of a DN string

A DN string is built up from the following basic elements:

- [OID](#).
- [Attribute types](#).
- [AVA](#).
- [RDN](#).

---

## OID

An OBJECT IDENTIFIER (OID) is a sequence of bytes that uniquely identifies a grammatical construct in ASN.1.

**Attribute types**

The variety of attribute types that could appear in a DN is theoretically open-ended, but in practice only a small subset of attribute types are used. [Table 13](#) shows a selection of the attribute types that you are most likely to encounter:

**Table 13:** *Commonly Used Attribute Types*

String Representation	X.500 Attribute Type	Size of Data	Equivalent OID
C	countryName	2	2.5.4.6
O	organizationName	1...64	2.5.4.10
OU	organizationalUnitName	1...64	2.5.4.11
CN	commonName	1...64	2.5.4.3
ST	stateOrProvinceName	1...64	2.5.4.8
L	localityName	1...64	2.5.4.7
STREET	streetAddress		
DC	domainComponent		
UID	userid		

**AVA**

An *attribute value assertion* (AVA) assigns an attribute value to an attribute type. In the string representation, it has the following syntax:

```
<attr-type>=<attr-value>
```

For example:

```
CN=A. N. Other
```

Alternatively, you can use the equivalent OID to identify the attribute type in the string representation (see [Table 13](#)). For example:

```
2.5.4.3=A. N. Other
```

**RDN**

---

A *relative distinguished name* (RDN) represents a single node of a DN (the bit that appears between the commas in the string representation).

Technically, an RDN might contain more than one AVA (it is formally defined as a set of AVAs); in practice, however, this almost never occurs. In the string representation, an RDN has the following syntax:

```
<attr-type>=<attr-value> [+<attr-type>=<attr-value> ...]
```

Here is an example of a (very unlikely) multiple-value RDN:

```
OU=Eng1+OU=Eng2+OU=Eng3
```

Here is an example of a single-value RDN:

```
OU=Engineering
```





# Action-Role Mapping DTD

*This appendix presents the document type definition (DTD) for the action-role mapping XML file.*

## DTD file

The action-role mapping DTD is shown in [Example 76](#).

### Example 76:

```
<?xml version="1.0" encoding="UTF-8"?>
<!ELEMENT action-name (#PCDATA)>
<!ELEMENT role-name (#PCDATA)>
<!ELEMENT server-name (#PCDATA)>
<!ELEMENT action-role-mapping (server-name, interface+)>
<!ELEMENT name (#PCDATA)>
<!ELEMENT interface (name, action-role+)>
<!ELEMENT action-role (action-name, role-name+)>
<!ELEMENT allow-unlisted-interfaces (#PCDATA)>
<!ELEMENT secure-system (allow-unlisted-interfaces*,
    action-role-mapping+)>
```

## Action-role mapping elements

The elements of the action-role mapping DTD can be described as follows:

`<!ELEMENT action-name (#PCDATA)>`

Specifies the action name to which permissions are assigned. The interpretation of the action name depends on the type of application:

- ◆ CORBA server—for IDL operations, the action name corresponds to the GIOP on-the-wire format of the operation name (usually the same as it appears in IDL).

For IDL attributes, the accessor or modifier action name corresponds to the GIOP on-the-wire format of the attribute accessor or modifier. For example, an IDL attribute, `foo`, would have an accessor, `_get_foo`, and a modifier, `_set_foo`.

- ◆ Artix server—for WSDL operations, the action name is equivalent to a WSDL operation name; that is, the `OperationName` from a tag, `<operation name="OperationName">`.

`<!ELEMENT action-role (action-name, role-name+)>`

Groups together a particular action and all of the roles permitted to perform that action.

`<!ELEMENT action-role-mapping (server-name, interface+)>`

Contains all of the permissions that apply to a particular server application.

`<!ELEMENT allow-unlisted-interfaces (#PCDATA)>`

Specifies the default access permissions that apply to interfaces not explicitly listed in the action-role mapping file. The element contents can have the following values:

- ◆ `true`—for any interfaces not listed, access to all of the interfaces' actions is allowed for all roles. If the remote user is unauthenticated (in the sense that no credentials are sent by the client), access is also allowed.

**Note:** However, if `<allow-unlisted-interfaces>` is `true` and a particular interface is listed, then only the actions explicitly listed within that interface's `interface` element are accessible. Unlisted actions from the listed interface are not accessible.

- ◆ `false`—for any interfaces not listed, access to all of the interfaces' actions is denied for all roles. Unauthenticated users are also denied access.

Default is `false`.

<!ELEMENT interface (name, action-role+)>

In the case of a CORBA server, the `interface` element contains all of the access permissions for one particular IDL interface.

In the case of an Artix server, the `interface` element contains all of the access permissions for one particular WSDL port type.

<!ELEMENT name (#PCDATA)>

Within the scope of an `interface` element, identifies the interface (IDL interface or WSDL port type) with which permissions are being associated. The format of the interface name depends on the type of application, as follows:

- ◆ CORBA server—the `name` element identifies the IDL interface using the interface's OMG repository ID. The repository ID normally consists of the characters `IDL:` followed by the fully scoped name of the interface (using `/` instead of `::` as the scoping character), followed by the characters `:1.0`. Hence, the `Simple::SimpleObject` IDL interface is identified by the `IDL:Simple/SimpleObject:1.0` repository ID.

**Note:** The form of the repository ID can also be affected by various `#pragma` directives appearing in the IDL file. A commonly used directive is `#pragma prefix`.

For example, the `CosNaming::NamingContext` interface in the naming service module, which uses the `omg.org` prefix, has the following repository ID: `IDL:omg.org/CosNaming/NamingContext:1.0`

- ◆ Artix server—the `name` element contains a WSDL port type name, specified in the following format:

*NamespaceURI:PortTypeName*

The *PortTypeName* comes from a tag, `<portType name="PortTypeName">`, defined in the *NamespaceURI* namespace. The *NamespaceURI* is usually defined in the `<definitions targetNamespace="NamespaceURI" ...>` tag of the WSDL contract.

<!ELEMENT role-name (#PCDATA)>

Specifies a role to which permission is granted. The role name can be any role that belongs to the server's Artix authorization realm (for CORBA bindings, the realm name is specified by the

`plugins:gsp:authorization_realm` configuration variable; for SOAP bindings, the realm name is specified by the `plugins:asp:authorization_realm` configuration variable) or to the `IONAGlobalRealm` realm. The roles themselves are defined in the security server backend; for example, in a file adapter file or in an LDAP backend.

```
<!ELEMENT secure-system (allow-unlisted-interfaces*,
  action-role-mapping+)>
```

The outermost scope of an action-role mapping file groups together a collection of `action-role-mapping` elements.

```
<!ELEMENT server-name (#PCDATA)>
```

The `server-name` element specifies the configuration scope (that is, the ORB name) used by the server in question. This is normally the value of the `-ORBname` parameter passed to the server executable on the command line.

# OpenSSL Utilities

*The `openssl` program consists of a large number of utilities that have been combined into one program. This appendix describes how you use the `openssl` program with Artix when managing X.509 certificates and private keys.*

---

**In this appendix**

This appendix contains the following sections:

<a href="#">Using OpenSSL Utilities</a>	<a href="#">page 528</a>
<a href="#">The OpenSSL Configuration File</a>	<a href="#">page 537</a>

---

# Using OpenSSL Utilities

---

## The OpenSSL package

This section describes a version of the `openssl` program that is available with Eric Young's OpenSSL package, which you can download from the OpenSSL Web site, <http://www.openssl.org>. OpenSSL is a publicly available implementation of the SSL protocol. Consult "License Issues" on page 555 for information about the copyright terms of OpenSSL.

**Note:** For complete documentation of the OpenSSL utilities, consult the documentation at the OpenSSL web site <http://www.openssl.org/docs>.

---

## Command syntax

An `openssl` command line takes the following form:

```
openssl utility arguments
```

For example:

```
openssl x509 -in OrbixCA -text
```

---

## The `openssl` utilities

This appendix describes four `openssl` utilities:

- `x509` Manipulates X.509 certificates.
  - `req` Creates and manipulates certificate signing requests, and self-signed certificates.
  - `rsa` Manipulates RSA private keys.
  - `ca` Implements a Certification Authority (CA).
- 

## The `-help` option

To get a list of the arguments associated with a particular command, use the `-help` option as follows:

```
openssl utility -help
```

For example:

```
openssl x509 -help
```

---

## The x509 Utility

---

### Purpose of the `x509` utility

In Artix the `x509` utility is mainly used for:

- Printing text details of certificates you wish to examine.
  - Converting certificates to different formats.
- 

### Options

The options supported by the `openssl x509` utility are as follows:

```
-inform arg      - input format - default PEM
                  (one of DER, NET or PEM)
-outform arg     - output format - default PEM
                  (one of DER, NET or PEM)
-keyform arg     - private key format - default PEM
-CAform arg      - CA format - default PEM
-CAkeyform arg   - CA key format - default PEM
-in arg          - input file - default stdin
-out arg         - output file - default stdout
-serial          - print serial number value
-hash            - print serial number value
-subject         - print subject DN
-issuer          - print issuer DN
-startdate       - notBefore field
-enddate         - notAfter field
-dates           - both Before and After dates
-modulus         - print the RSA key modulus
-fingerprint     - print the certificate fingerprint
-noout           - no certificate output
-days arg        - How long till expiry of a signed certificate
                  - def 30 days
-signkey arg     - self sign cert with arg
-x509toreq       - output a certification request object
-req             - input is a certificate request, sign and
                  output
-CA arg          - set the CA certificate, must be PEM format
```

```

-CAkey arg      - set the CA key, must be PEM format. If missing
                  it is assumed to be in the CA file
-CAcreateserial - create serial number file if it does not exist
-CAserial       - serial file
-text           - print the certificate in text form
-C             - print out C code forms
-md2/-md5/-sha1/ - digest to do an RSA sign with
-mdc2

```

---

### Using the x509 utility

To print the text details of an existing PEM-format X.509 certificate, use the `x509` utility as follows:

```
openssl x509 -in MyCert.pem -inform PEM -text
```

To print the text details of an existing DER-format X.509 certificate, use the `x509` utility as follows:

```
openssl x509 -in MyCert.der -inform DER -text
```

To change a certificate from PEM format to DER format, use the `x509` utility as follows:

```
openssl x509 -in MyCert.pem -inform PEM -outform DER -out
MyCert.der
```



---

## The req Utility

### Purpose of the `x509` utility

The `req` utility is used to generate a self-signed certificate or a certificate signing request (CSR). A CSR contains details of a certificate to be issued by a CA. When creating a CSR, the `req` command prompts you for the necessary information from which a certificate request file and an encrypted private key file are produced. The certificate request is then submitted to a CA for signing.

If the `-nodes` (no DES) parameter is not supplied to `req`, you are prompted for a pass phrase which will be used to protect the private key.

**Note:** It is important to specify a validity period (using the `-days` parameter). If the certificate expires, applications that are using that certificate will not be authenticated successfully.

### Options

The options supported by the `openssl req` utility are as follows:

<code>-inform arg</code>	input format - one of DER TXT PEM
<code>-outform</code>	arg output format - one of DER TXT PEM
<code>-in arg</code>	inout file
<code>-out arg</code>	output file
<code>-text</code>	text form of request
<code>-noout</code>	do not output REQ
<code>-verify</code>	verify signature on REQ
<code>-modulus</code>	RSA modulus
<code>-nodes</code>	do not encrypt the output key
<code>-key file</code>	use the private key contained in file
<code>-keyform arg</code>	key file format
<code>-keyout arg</code>	file to send the key to
<code>-newkey rsa:bits</code>	generate a new RSA key of 'bits' in size
<code>-newkey dsa:file</code>	generate a new DSA key, parameters taken from CA in 'file'
<code>-[digest]</code>	Digest to sign with (md5, sha1, md2, mdc2)
<code>-config file</code>	request template file

<code>-new</code>	new request
<code>-x509</code>	output an x509 structure instead of a certificate req. (Used for creating self signed certificates)
<code>-days</code>	number of days an x509 generated by <code>-x509</code> is valid for
<code>-asn1-kludge</code>	Output the 'request' in a format that is wrong but some CA's have been reported as requiring [It is now always turned on but can be turned off with <code>-no-asn1-kludge</code> ]

### Using the req Utility

To create a self-signed certificate with an expiry date a year from now, the `req` utility can be used as follows to create the certificate `CA_cert.pem` and the corresponding encrypted private key file `CA_pk.pem`:

```
openssl req -config ssl_conf_path_name -days 365
-out CA_cert.pem -new -x509 -keyout CA_pk.pem
```

This following command creates the certificate request `MyReq.pem` and the corresponding encrypted private key file `MyEncryptedKey.pem`:

```
openssl req -config ssl_conf_path_name -days 365
-out MyReq.pem -new -keyout MyEncryptedKey.pem
```

---

## The rsa Utility

---

### Purpose of the `rsa` utility

The `rsa` command is a useful utility for examining and modifying RSA private key files. Generally RSA keys are stored encrypted with a symmetric algorithm using a user-supplied pass phrase. The OpenSSL `req` command prompts the user for a pass phrase in order to encrypt the private key. By default, `req` uses the triple DES algorithm. The `rsa` command can be used to change the password that protects the private key and to convert the format of the private key. Any `rsa` command that involves reading an encrypted `rsa` private key will prompt for the PEM pass phrase used to encrypt it.

---

### Options

The options supported by the `openssl rsa` utility are as follows:

<code>-inform arg</code>	input format - one of DER NET PEM
<code>-outform arg</code>	output format - one of DER NET PEM
<code>-in arg</code>	inout file
<code>-out arg</code>	output file
<code>-des</code>	encrypt PEM output with cbc des
<code>-des3</code>	encrypt PEM output with ede cbc des using 168 bit key
<code>-text</code>	print the key in text
<code>-noout</code>	do not print key out
<code>-modulus</code>	print the RSA key modulus

---

### Using the `rsa` Utility

Converting a private key to PEM format from DER format involves using the `rsa` utility as follows:

```
openssl rsa -inform DER -in MyKey.der -outform PEM -out MyKey.pem
```

Changing the pass phrase which is used to encrypt the private key involves using the `rsa` utility as follows:

```
openssl rsa -inform PEM -in MyKey.pem -outform PEM -out MyKey.pem  
-des3
```

Removing encryption from the private key (which is not recommended) involves using the `rsa` command utility as follows:

```
openssl rsa -inform PEM -in MyKey.pem -outform PEM -out MyKey2.pem
```

**Note:** Do not specify the same file for the `-in` and `-out` parameters, because this can corrupt the file.

---

## The ca Utility

---

### Purpose of the `ca` utility

You can use the `ca` utility create X.509 certificates by signing existing signing requests. It is imperative that you check the details of a certificate request before signing. Your organization should have a policy with respect to the issuing of certificates.

The `ca` utility is used to sign certificate requests thereby creating a valid X.509 certificate which can be returned to the request submitter. It can also be used to generate Certificate Revocation Lists (CRLS). For information on the `ca -policy` and `-name` options, refer to [“The OpenSSL Configuration File” on page 537](#).

---

### Creating a new CA

To create a new CA using the `openssl ca` utility, two files (`serial` and `index.txt`) need to be created in the location specified by the `openssl` configuration file that you are using.

---

### Options

The options supported by the `openssl ca` utility are as follows:

<code>-verbose</code>	- Talk alot while doing things
<code>-config file</code>	- A config file
<code>-name arg</code>	- The particular CA definition to use
<code>-gencrl</code>	- Generate a new CRL
<code>-crl days days</code>	- Days is when the next CRL is due
<code>-crl hours hours</code>	- Hours is when the next CRL is due
<code>-days arg</code>	- number of days to certify the certificate for
<code>-md arg</code>	- md to use, one of md2, md5, sha or sha1
<code>-policy arg</code>	- The CA 'policy' to support
<code>-keyfile arg</code>	- PEM private key file
<code>-key arg</code>	- key to decode the private key if it is encrypted
<code>-cert</code>	- The CA certificate
<code>-in file</code>	- The input PEM encoded certificate request(s)
<code>-out file</code>	- Where to put the output file(s)
<code>-outdir dir</code>	- Where to put output certificates

```
-infile...      - The last argument, requests to process
-spkac file     - File contains DN and signed public key and
                challenge
-preserveDN     - Do not re-order the DN
-batch         - Do not ask questions
-msie_hack     - msie modifications to handle all thos
                universal strings
```

**Note:** Most of the above parameters have default values as defined in `openssl.cnf`.

---

### Using the `ca` Utility

Converting a private key to PEM format from DER format involves using the `ca` utility as shown in the following example. To sign the supplied CSR `MyReq.pem` to be valid for 365 days and create a new X.509 certificate in PEM format, use the `ca` utility as follows:

```
openssl ca -config ssl_conf_path_name -days 365
-in MyReq.pem -out MyNewCert.pem
```

---

# The OpenSSL Configuration File

---

## Overview

A number of OpenSSL commands (for example, `req` and `ca`) take a `-config` parameter that specifies the location of the openssl configuration file. This section provides a brief description of the format of the configuration file and how it applies to the `req` and `ca` commands. An example configuration file is listed at the end of this section.

---

## Structure of `openssl.cnf`

The `openssl.cnf` configuration file consists of a number of sections that specify a series of default values that are used by the openssl commands.

---

## In this section

This section contains the following subsections:

<a href="#">[req] Variables</a>	<a href="#">page 538</a>
<a href="#">[ca] Variables</a>	<a href="#">page 539</a>
<a href="#">[policy] Variables</a>	<a href="#">page 540</a>
<a href="#">Example openssl.cnf File</a>	<a href="#">page 541</a>

---

## [req] Variables

---

### Overview of the variables

The `req` section contains the following variables:

```
default_bits = 1024
default_keyfile = privkey.pem
distinguished_name = req_distinguished_name
attributes = req_attributes
```

---

### `default_bits` configuration variable

The `default_bits` variable is the default RSA key size that you wish to use. Other possible values are 512, 2048, and 4096.

---

### `default_keyfile` configuration variable

The `default_keyfile` variable is the default name for the private key file created by `req`.

---

### `distinguished_name` configuration variable

The `distinguished_name` variable specifies the section in the configuration file that defines the default values for components of the distinguished name field. The `req_attributes` variable specifies the section in the configuration file that defines defaults for certificate request attributes.



---

## [ca] Variables

---

### Choosing the CA section

You can configure the file `openssl.cnf` to support a number of CAs that have different policies for signing CSRs. The `-name` parameter to the `ca` command specifies which CA section to use. For example:

```
openssl ca -name MyCa ...
```

This command refers to the CA section `[MyCa]`. If `-name` is not supplied to the `ca` command, the CA section used is the one indicated by the `default_ca` variable. In the [“Example openssl.cnf File” on page 541](#), this is set to `CA_default` (which is the name of another section listing the defaults for a number of settings associated with the `ca` command). Multiple different CAs can be supported in the configuration file, but there can be only one default CA.

---

### Overview of the variables

Possible `[ca]` variables include the following

`dir`: The location for the CA database

The database is a simple text database containing the following tab separated fields:

`status`: A value of 'R' - revoked, 'E' -expired or 'V' valid

`issued date`: When the certificate was certified

`revoked date`: When it was revoked, blank if not revoked

`serial number`: The certificate serial number

`certificate`: Where the certificate is located

`CN`: The name of the certificate

The `serial number` field should be unique, as should the `CN/status` combination. The `ca` utility checks these at startup.

`certs`: This is where all the previously issued certificates are kept

---

## [policy] Variables

---

### Choosing the policy section

The policy variable specifies the default policy section to be used if the `-policy` argument is not supplied to the `ca` command. The CA policy section of a configuration file identifies the requirements for the contents of a certificate request which must be met before it is signed by the CA.

There are two policy sections defined in the [“Example openssl.cnf File” on page 541](#): `policy_match` and `policy_anything`.

---

### Example policy section

The `policy_match` section of the example `openssl.cnf` file specifies the order of the attributes in the generated certificate as follows:

```
countryName
stateOrProvinceName
organizationName
organizationalUnitName
commonName
emailAddress
```

---

### The `match` policy value

Consider the following value:

```
countryName = match
```

This means that the country name must match the CA certificate.

---

### The `optional` policy value

Consider the following value:

```
organisationalUnitName = optional
```

This means that the `organisationalUnitName` does not have to be present.

---

### The `supplied` policy value

Consider the following value:

```
commonName = supplied
```

This means that the `commonName` must be supplied in the certificate request.

---

## Example openssl.cnf File

---

**Listing**

The following listing shows the contents of an example `openssl.cnf` configuration file:

```
#####
# openssl example configuration file.
# This is mostly used for generation of certificate requests.
#####
[ ca ]
default_ca= CA_default          # The default ca section
#####

[ CA_default ]

dir=/opt/iona/OrbixSSL1.0c/certs # Where everything is kept

certs=$dir # Where the issued certs are kept
crl_dir= $dir/crl # Where the issued crl are kept
database= $dir/index.txt # database index file
new_certs_dir= $dir/new_certs # default place for new certs
certificate=$dir/CA/OrbixCA # The CA certificate
serial= $dir/serial # The current serial number
crl= $dir/crl.pem # The current CRL
private_key= $dir/CA/OrbixCA.pk # The private key
RANDFILE= $dir/.rand # private random number file
default_days= 365 # how long to certify for
default_crl_days= 30 # how long before next CRL
default_md= md5 # which message digest to use
preserve= no # keep passed DN ordering

# A few different ways of specifying how closely the request
# should conform to the details of the CA

policy= policy_match

# For the CA policy

[policy_match]
countryName= match
stateOrProvinceName= match
organizationName= match
organizationalUnitName= optional
commonName= supplied
```

```

emailAddress= optional

# For the 'anything' policy
# At this point in time, you must list all acceptable 'object'
# types

[ policy_anything ]
countryName = optional
stateOrProvinceName= optional
localityName= optional
organizationName = optional
organizationalUnitName = optional
commonName= supplied
emailAddress= optional

[ req ]
default_bits = 1024
default_keyfile= privkey.pem
distinguished_name = req_distinguished_name
attributes = req_attributes

[ req_distinguished_name ]
countryName= Country Name (2 letter code)
countryName_min= 2
countryName_max = 2
stateOrProvinceName= State or Province Name (full name)
localityName = Locality Name (eg, city)
organizationName = Organization Name (eg, company)
organizationalUnitName = Organizational Unit Name (eg, section)
commonName = Common Name (eg. YOUR name)
commonName_max = 64
emailAddress = Email Address
emailAddress_max = 40

[ req_attributes ]
challengePassword = A challenge password
challengePassword_min = 4
challengePassword_max = 20
unstructuredName= An optional company name

```

# bus-security C++ Context Data

*This appendix lists the bus-security C++ context data types. You can use these C++ types in conjunction with the context API to set the security properties programmatically.*

---

## C++ mapped classes

[Example 77](#) shows the context data types that are generated when the `bus-security.xsd` schema is mapped to C++.

### **Example 77:** *The bus-security C++ Context Data Types*

```
// C++
namespace IT_ContextAttributes
{
    ...
    class BusSecurityLevel : public IT_Bus::AnySimpleType
    {
    public:
        ...
        static const IT_Bus::String MESSAGE_LEVEL;
        static const IT_Bus::String REQUEST_LEVEL;
        ...
        BusSecurityLevel();
        BusSecurityLevel(const BusSecurityLevel & copy);
        BusSecurityLevel(const IT_Bus::String & value);
        virtual ~BusSecurityLevel();
        ...
        void setvalue(const IT_Bus::String & value);
    };
};
```

**Example 77:** *The bus-security C++ Context Data Types*

```

        const IT_Bus::String & getvalue() const;
        ...
    };
    typedef IT_AutoPtr<BusSecurityLevel> BusSecurityLevelPtr;

    class BusSecurityType : public IT_Bus::AnySimpleType
    {
    public:
        ...
        static const IT_Bus::String USERNAME_PASSWORD;
        static const IT_Bus::String PRINCIPAL;
        static const IT_Bus::String CERT_SUBJECT;
        static const IT_Bus::String ENCODED_TOKEN;
        static const IT_Bus::String KERBEROS_TOKEN;
        ...
        BusSecurityType();
        BusSecurityType(const BusSecurityType & copy);
        BusSecurityType(const IT_Bus::String & value);
        virtual ~BusSecurityType();
        ...
        void setvalue(const IT_Bus::String & value);
        const IT_Bus::String & getvalue() const;
        ...
    };
    typedef IT_AutoPtr<BusSecurityType> BusSecurityTypePtr;

    class BusSecurity
    : public IT_tExtensibilityElementData,
      public virtual IT_Bus::ComplexContentComplexType
    {
    public:
        ...
        BusSecurity();
        BusSecurity(const BusSecurity & copy);
        virtual ~BusSecurity();
        ...
        IT_Bus::String *
        getis2AuthorizationActionRoleMapping();

        const IT_Bus::String *
        getis2AuthorizationActionRoleMapping() const;

        void setis2AuthorizationActionRoleMapping(
            const IT_Bus::String * val
        );
    };

```

### Example 77: *The bus-security C++ Context Data Types*

```
void setis2AuthorizationActionRoleMapping(
    const IT_Bus::String & val
);

IT_Bus::Boolean * getenableSecurity();
const IT_Bus::Boolean * getenableSecurity() const;
void setenableSecurity(const IT_Bus::Boolean * val);
void setenableSecurity(const IT_Bus::Boolean & val);

IT_Bus::Boolean * getenableAuthorization();
const IT_Bus::Boolean * getenableAuthorization() const;
void setenableAuthorization(const IT_Bus::Boolean * val);
void setenableAuthorization(const IT_Bus::Boolean & val);

IT_Bus::Boolean * getenableSSO();
const IT_Bus::Boolean * getenableSSO() const;
void setenableSSO(const IT_Bus::Boolean * val);
void setenableSSO(const IT_Bus::Boolean & val);

BusSecurityLevel * getsecurityLevel();
const BusSecurityLevel * getsecurityLevel() const;
void setsecurityLevel(const BusSecurityLevel * val);
void setsecurityLevel(const BusSecurityLevel & val);

BusSecurityType * getsecurity_Type();
const BusSecurityType * getsecurity_Type() const;
void setsecurity_Type(const BusSecurityType * val);
void setsecurity_Type(const BusSecurityType & val);

IT_Bus::Int * getauthenticationCacheSize();
const IT_Bus::Int * getauthenticationCacheSize() const;
void setauthenticationCacheSize(const IT_Bus::Int * val);
void setauthenticationCacheSize(const IT_Bus::Int & val);

IT_Bus::Int * getauthenticationCacheTimeout();
const IT_Bus::Int * getauthenticationCacheTimeout()
const;
void setauthenticationCacheTimeout(
    const IT_Bus::Int * val
);
void setauthenticationCacheTimeout(
    const IT_Bus::Int & val
);
```

**Example 77:** *The bus-security C++ Context Data Types*

```

IT_Bus::String * getauthorizationRealm();
const IT_Bus::String * getauthorizationRealm() const;
void setauthorizationRealm(const IT_Bus::String * val);
void setauthorizationRealm(const IT_Bus::String & val);

IT_Bus::String * getDefaultPassword();
const IT_Bus::String * getDefaultPassword() const;
void setdefaultPassword(const IT_Bus::String * val);
void setdefaultPassword(const IT_Bus::String & val);

IT_Bus::String * getPrincipal();
const IT_Bus::String * getPrincipal() const;
void setPrincipal(const IT_Bus::String * val);
void setPrincipal(const IT_Bus::String & val);

IT_Bus::String * getWSSEKerberosv5SToken();
const IT_Bus::String * getWSSEKerberosv5SToken() const;
void setWSSEKerberosv5SToken(const IT_Bus::String * val);
void setWSSEKerberosv5SToken(const IT_Bus::String & val);

IT_Bus::String * getWSSEUsernameToken();
const IT_Bus::String * getWSSEUsernameToken() const;
void setWSSEUsernameToken(const IT_Bus::String * val);
void setWSSEUsernameToken(const IT_Bus::String & val);

IT_Bus::String * getWSSEPasswordToken();
const IT_Bus::String * getWSSEPasswordToken() const;
void setWSSEPasswordToken(const IT_Bus::String * val);
void setWSSEPasswordToken(const IT_Bus::String & val);

IT_Bus::String * getWSSEX509Cert();
const IT_Bus::String * getWSSEX509Cert() const;
void setWSSEX509Cert(const IT_Bus::String * val);
void setWSSEX509Cert(const IT_Bus::String & val);

IT_Bus::String * getUsername();
const IT_Bus::String * getUsername() const;
void setUsername(const IT_Bus::String * val);
void setUsername(const IT_Bus::String & val);

IT_Bus::String * getPassword();
const IT_Bus::String * getPassword() const;
void setPassword(const IT_Bus::String * val);
void setPassword(const IT_Bus::String & val);

```



**Example 77:** *The bus-security C++ Context Data Types*

```
IT_Bus::String * getSSOToken();
const IT_Bus::String * getSSOToken() const;
void setSSOToken(const IT_Bus::String * val);
void setSSOToken(const IT_Bus::String & val);

IT_Bus::String * getCertificateSubject();
const IT_Bus::String * getCertificateSubject() const;
void setCertificateSubject(const IT_Bus::String * val);
void setCertificateSubject(const IT_Bus::String & val);

IT_Bus::String * getencoded_token();
const IT_Bus::String * getencoded_token() const;
void setencoded_token(const IT_Bus::String * val);
void setencoded_token(const IT_Bus::String & val);

IT_Bus::Boolean * getIsTransportCredential();
const IT_Bus::Boolean * getIsTransportCredential() const;
void setIsTransportCredential(
    const IT_Bus::Boolean * val
);
void setIsTransportCredential(
    const IT_Bus::Boolean & val
);
...
};
typedef IT_AutoPtr<BusSecurity> BusSecurityPtr;
}
```



# bus-security Java Context Data

*This appendix lists the bus-security Java context data types. You can use these Java types in conjunction with the context API to set the security properties programmatically.*

---

## Java BusSecurityLevel class

The `BusSecurityLevel` type is used to set the `securityLevel` attribute of the `BusSecurity` context. [Example 78](#) shows the definition of the `BusSecurityLevel` class.

### Example 78: The `BusSecurityLevel` Class

```
// Java
package com.iona.schemas.bus.security_context;

import java.util.*;
import java.lang.String;

public class BusSecurityLevel {
    public static final String TARGET_NAMESPACE =
        "http://schemas.iona.com/bus/security_context";
    ...
    public static final String _MESSAGE_LEVEL = "MESSAGE_LEVEL";
    public static final
    com.iona.schemas.bus.security_context.BusSecurityLevel
    MESSAGE_LEVEL = new
    com.iona.schemas.bus.security_context.BusSecurityLevel(_MESSA
    GE_LEVEL);
```

**Example 78:** *The BusSecurityLevel Class*

```

    public static final String _REQUEST_LEVEL = "REQUEST_LEVEL";
    public static final
    com.iona.schemas.bus.security_context.BusSecurityLevel
    REQUEST_LEVEL = new
    com.iona.schemas.bus.security_context.BusSecurityLevel(_REQUE
    ST_LEVEL);
    ...
    public String getValue();

    public static
    com.iona.schemas.bus.security_context.BusSecurityLevel
    fromValue(String value);

    public static
    com.iona.schemas.bus.security_context.BusSecurityLevel
    fromString(String value);

    public String toString();
}

```

**Java BusSecurityType class**

The `BusSecurityType` type is used to set the `securityType` attribute of the `BusSecurity` context. [Example 78](#) shows the definition of the `BusSecurityType` class.

**Example 79:** *The BusSecurityType Class*

```

// Java
package com.iona.schemas.bus.security_context;

import java.util.*;
import java.lang.String;

public class BusSecurityType {
    public static final String TARGET_NAMESPACE =
    "http://schemas.iona.com/bus/security_context";
    ...
    public static final String _USERNAME_PASSWORD =
    "USERNAME_PASSWORD";
}

```

### Example 79: *The BusSecurityType Class*

```
public static final
com.iona.schemas.bus.security_context.BusSecurityType
USERNAME_PASSWORD = new
com.iona.schemas.bus.security_context.BusSecurityType(_USERSNA
ME_PASSWORD);

public static final String _PRINCIPAL = "PRINCIPAL";
public static final
com.iona.schemas.bus.security_context.BusSecurityType
PRINCIPAL = new
com.iona.schemas.bus.security_context.BusSecurityType(_PRINCI
PAL);

public static final String _CERT_SUBJECT = "CERT_SUBJECT";
public static final
com.iona.schemas.bus.security_context.BusSecurityType
CERT_SUBJECT = new
com.iona.schemas.bus.security_context.BusSecurityType(_CERT_S
UBJECT);

public static final String _ENCODED_TOKEN = "ENCODED_TOKEN";
public static final
com.iona.schemas.bus.security_context.BusSecurityType
ENCODED_TOKEN = new
com.iona.schemas.bus.security_context.BusSecurityType(_ENCODE
D_TOKEN);

public static final String _KERBEROS_TOKEN =
"KERBEROS_TOKEN";
public static final
com.iona.schemas.bus.security_context.BusSecurityType
KERBEROS_TOKEN = new
com.iona.schemas.bus.security_context.BusSecurityType(_KERBER
OS_TOKEN);
...
public String getValue();

public static
com.iona.schemas.bus.security_context.BusSecurityType
fromValue(String value);

public static
com.iona.schemas.bus.security_context.BusSecurityType
fromString(String value);
```

**Example 79:** *The BusSecurityType Class*

```

    public String toString();
}

```

**Java BusSecurity class**

**Example 80** shows the definition of the `BusSecurity` context data type that are generated when the `bus-security.xsd` schema is mapped to Java.

**Example 80:** *The BusSecurity Context Data Type, Java*

```

// Java
package com.iona.schemas.bus.security_context;

import java.util.*;

import java.lang.String;
import java.lang.Boolean;
import java.lang.Integer;

public class BusSecurity extends
    org.xmlsoap.schemas.wsdl.context.TExtensibilityElement {

    public static final String TARGET_NAMESPACE =
        "http://schemas.iona.com/bus/security_context";
    ...
    public String getIs2AuthorizationActionRoleMapping();
    public void setIs2AuthorizationActionRoleMapping(String val);

    public Boolean isEnableSecurity();
    public void setEnableSecurity(Boolean val);

    public Boolean isEnableAuthorization();
    public void setEnableAuthorization(Boolean val);

    public Boolean isEnableSSO();
    public void setEnableSSO(Boolean val);

    public BusSecurityLevel getSecurityLevel();
    public void setSecurityLevel(BusSecurityLevel val);

    public BusSecurityType getSecurity_Type();
    public void setSecurity_Type(BusSecurityType val);

    public Integer getAuthenticationCacheSize();
    public void setAuthenticationCacheSize(Integer val);
}

```

**Example 80:** *The BusSecurity Context Data Type, Java*

```
public Integer getAuthenticationCacheTimeout();
public void    setAuthenticationCacheTimeout(Integer val);

public String  getAuthorizationRealm();
public void    setAuthorizationRealm(String val);

public String  getDefaultPassword();
public void    setDefaultPassword(String val);

public String  getPrincipal();
public void    setPrincipal(String val);

public String  getWSSEKerberosv5SToken();
public void    setWSSEKerberosv5SToken(String val);

public String  getWSSEUsernameToken();
public void    setWSSEUsernameToken(String val);

public String  getWSSEPasswordToken();
public void    setWSSEPasswordToken(String val);

public String  getWSSEX509Cert();
public void    setWSSEX509Cert(String val);

public String  getUsername();
public void    setUsername(String val);

public String  getPassword();
public void    setPassword(String val);

public String  getSSOToken();
public void    setSSOToken(String val);

public String  getCertificateSubject();
public void    setCertificateSubject(String val);

public String  getEncoded_token();
public void    setEncoded_token(String val);

public Boolean isIsTransportCredential();
public void    setIsTransportCredential(Boolean val);

public String  toString();
}
```





# License Issues

*This appendix contains the text of licenses relevant to Artix.*

---

## **In this appendix**

This appendix contains the following section:

<a href="#">OpenSSL License</a>	<a href="#">page 556</a>
---------------------------------	--------------------------

---

# OpenSSL License

---

## Overview

The licence agreement for the usage of the OpenSSL command line utility shipped with Artix SSL/TLS is as follows:

### LICENSE ISSUES

```
=====
The OpenSSL toolkit stays under a dual license, i.e. both the conditions of
the OpenSSL license and the original SSLeay license apply to the toolkit.
See below for the actual license texts. Actually both licenses are BSD-style
Open Source licenses. In case of any license issues related to OpenSSL
please contact openssl-core@openssl.org.
```

#### OpenSSL License

```
-----
/* =====
* Copyright (c) 1998-1999 The OpenSSL Project. All rights reserved.
*
* Redistribution and use in source and binary forms, with or without
* modification, are permitted provided that the following conditions
* are met:
*
* 1. Redistributions of source code must retain the above copyright
* notice, this list of conditions and the following disclaimer.
*
* 2. Redistributions in binary form must reproduce the above copyright
* notice, this list of conditions and the following disclaimer in
* the documentation and/or other materials provided with the
* distribution.
*
* 3. All advertising materials mentioning features or use of this
* software must display the following acknowledgment:
* "This product includes software developed by the OpenSSL Project
* for use in the OpenSSL Toolkit. (http://www.openssl.org/)"
*
* 4. The names "OpenSSL Toolkit" and "OpenSSL Project" must not be used to
* endorse or promote products derived from this software without
* prior written permission. For written permission, please contact
* openssl-core@openssl.org.
*
* 5. Products derived from this software may not be called "OpenSSL"
* nor may "OpenSSL" appear in their names without prior written
* permission of the OpenSSL Project.
```

```

*
* 6. Redistributions of any form whatsoever must retain the following
* acknowledgment:
* "This product includes software developed by the OpenSSL Project
* for use in the OpenSSL Toolkit (http://www.openssl.org/)"
*
* THIS SOFTWARE IS PROVIDED BY THE OpenSSL PROJECT ``AS IS'' AND ANY
* EXPRESSED OR IMPLIED WARRANTIES, INCLUDING, BUT NOT LIMITED TO, THE
* IMPLIED WARRANTIES OF MERCHANTABILITY AND FITNESS FOR A PARTICULAR
* PURPOSE ARE DISCLAIMED. IN NO EVENT SHALL THE OpenSSL PROJECT OR
* ITS CONTRIBUTORS BE LIABLE FOR ANY DIRECT, INDIRECT, INCIDENTAL,
* SPECIAL, EXEMPLARY, OR CONSEQUENTIAL DAMAGES (INCLUDING, BUT
* NOT LIMITED TO, PROCUREMENT OF SUBSTITUTE GOODS OR SERVICES;
* LOSS OF USE, DATA, OR PROFITS; OR BUSINESS INTERRUPTION)
* HOWEVER CAUSED AND ON ANY THEORY OF LIABILITY, WHETHER IN CONTRACT,
* STRICT LIABILITY, OR TORT (INCLUDING NEGLIGENCE OR OTHERWISE)
* ARISING IN ANY WAY OUT OF THE USE OF THIS SOFTWARE, EVEN IF ADVISED
* OF THE POSSIBILITY OF SUCH DAMAGE.
* =====
*
* This product includes cryptographic software written by Eric Young
* (eay@cryptsoft.com). This product includes software written by Tim
* Hudson (tjh@cryptsoft.com).
*
*/

```

## Original SSLeay License

```
-----
```

```

/* Copyright (C) 1995-1998 Eric Young (eay@cryptsoft.com)
* All rights reserved.
*
* This package is an SSL implementation written
* by Eric Young (eay@cryptsoft.com).
* The implementation was written so as to conform with Netscapes SSL.
*
* This library is free for commercial and non-commercial use as long as
* the following conditions are aheared to. The following conditions
* apply to all code found in this distribution, be it the RC4, RSA,
* lhash, DES, etc., code; not just the SSL code. The SSL documentation
* included with this distribution is covered by the same copyright terms
* except that the holder is Tim Hudson (tjh@cryptsoft.com).
*
* Copyright remains Eric Young's, and as such any Copyright notices in
* the code are not to be removed.
* If this package is used in a product, Eric Young should be given attribution
* as the author of the parts of the library used.

```

```

* This can be in the form of a textual message at program startup or
* in documentation (online or textual) provided with the package.
*
* Redistribution and use in source and binary forms, with or without
* modification, are permitted provided that the following conditions
* are met:
* 1. Redistributions of source code must retain the copyright
*   notice, this list of conditions and the following disclaimer.
* 2. Redistributions in binary form must reproduce the above copyright
*   notice, this list of conditions and the following disclaimer in the
*   documentation and/or other materials provided with the distribution.
* 3. All advertising materials mentioning features or use of this software
*   must display the following acknowledgement:
*   "This product includes cryptographic software written by
*   Eric Young (eay@cryptsoft.com)"
*   The word 'cryptographic' can be left out if the rouines from the library
*   being used are not cryptographic related :-).
* 4. If you include any Windows specific code (or a derivative thereof) from
*   the apps directory (application code) you must include an acknowledgement:
*   "This product includes software written by Tim Hudson (tjh@cryptsoft.com)"
*
* THIS SOFTWARE IS PROVIDED BY ERIC YOUNG ``AS IS'' AND
* ANY EXPRESS OR IMPLIED WARRANTIES, INCLUDING, BUT NOT LIMITED TO, THE
* IMPLIED WARRANTIES OF MERCHANTABILITY AND FITNESS FOR A PARTICULAR PURPOSE
* ARE DISCLAIMED.  IN NO EVENT SHALL THE AUTHOR OR CONTRIBUTORS BE LIABLE
* FOR ANY DIRECT, INDIRECT, INCIDENTAL, SPECIAL, EXEMPLARY, OR CONSEQUENTIAL
* DAMAGES (INCLUDING, BUT NOT LIMITED TO, PROCUREMENT OF SUBSTITUTE GOODS
* OR SERVICES; LOSS OF USE, DATA, OR PROFITS; OR BUSINESS INTERRUPTION)
* HOWEVER CAUSED AND ON ANY THEORY OF LIABILITY, WHETHER IN CONTRACT, STRICT
* LIABILITY, OR TORT (INCLUDING NEGLIGENCE OR OTHERWISE) ARISING IN ANY WAY
* OUT OF THE USE OF THIS SOFTWARE, EVEN IF ADVISED OF THE POSSIBILITY OF
* SUCH DAMAGE.
*
* The licence and distribution terms for any publically available version or
* derivative of this code cannot be changed.  i.e. this code cannot simply be
* copied and put under another distribution licence
* [including the GNU Public Licence.]
*/

```

# Index

## Symbols

.NET

- and principal propagation 315
- <action-role-mapping> tag 218
- <interface> tag 218
- <name> tag 218
- <realm> tag 211
- <role> tag 211
- <server-name> tag 218
- <users> tag 211

## A

access control  
wsdltoacl utility 220

ACL

- <action-role-mapping> tag 218
- <interface> tag 218
- <name> tag 218
- <server-name> tag 218
- action\_role\_mapping configuration variable 223
- action-role mapping file 217
- action-role mapping file, example 217
- action-role mapping
  - and role-based access control 205
- action\_role\_mapping configuration variable 94, 223
- action-role mapping file
  - <action-role-mapping> tag 218
  - <interface> tag 218
  - <name> tag 218
  - <server-name> tag 218

CORBA

- configuring 217
- example 217
- administration
  - OpenSSL command-line utilities 235
- and iSF adapter properties 395
- Artix security layer
  - and certificate-based authentication 66
- Artix security plug-in
  - and security layer 43
  - authentication\_cache\_size configuration variable 46
- Artix security plug-in plug-in

authentication\_cache\_timeout configuration variable 46

Artix security service

- and embedded deployment 381
- architecture 377
- configuring 145
- definition 378
- features 378
- file adapter 167
- is2.properties file 167
- LDAP adapter 169
- LDAP adapter, properties 170
- log4j logging 199
- plugins:java\_server:classpath configuration variable 396
- security information file 167
- standalone deployment of 380

ASN.1 227, 517

- attribute types 520
- AVA 520
- OID 519
- RDN 521

ASP plug-in

- caching of credentials 45

asp plug-in

- default\_password configuration value 310
- security\_type configuration variable 310

ASP security layer

- and HTTP 49
- and SOAP binding 73

association options

- and cipher suite constraints 302
- and mechanism policy 291
- client secure invocation policy, default 287
- compatibility with cipher suites 303
- EstablishTrustInClient 55, 56, 86, 100
- NoProtection 89
- rules of thumb 291
- SSL/TLS
  - Confidentiality 285
  - DetectMisordering 285
  - DetectReplay 285
  - EstablishTrustInClient 286

- EstablishTrustInTarget 286
- Integrity 285
- NoProtection 285
- setting 282
- target secure invocation policy, default 289, 290
- attribute value assertion 520
- authenticate() method
  - in IS2Adapter 389
- authentication
  - and security layer 43
  - caching of credentials 45
  - certificate-based 40
  - CSI 40
  - HTTP Basic Authentication 40
  - iSF
    - process of 91
  - own certificate, specifying 268
  - pass phrase
    - dialog prompt, C++ 270
    - in configuration 271
    - password file, from 270
  - SSL/TLS
    - mutual 264
    - target only 261
    - trusted CA list 267
- authentication\_cache\_size configuration
  - variable 45, 46
- authentication\_cache\_timeout configuration
  - variable 45, 46
- authorization
  - and security layer 43
  - caching of credentials 45
  - role-based access control 205
  - roles
    - creating 207
    - special 209
- authorization realm
  - adding a server 206
  - IONAGlobalRealm realm 209
  - iSF 205
  - iSF, setting in server 94
  - roles in 207
  - servers in 206
  - special 209
- authorization realms
  - creating 207
- AVA 520

**B**

- backward trust 101
- Baltimore toolkit
  - selecting for C++ applications 407
- Basic Encoding Rules 518
- BER 518
- bus:security 141
- bus-security:security interceptor 64, 116

**C**

- CA 226
  - choosing a host 230
  - commercial CAs 229
  - index file 237
  - list of trusted 232
  - multiple CAs 232
  - private CAs 230
  - private key, creating 238
  - security precautions 230
  - See *A/socertificate* authority
  - self-signed 238
  - serial file 237
  - trusted list 248, 267
  - 539
- CA, setting up 236
- CACHE\_CLIENT session caching value 305
- CACHE\_NONE session caching value 305
- CACHE\_SERVER\_AND\_CLIENT session caching
  - value 305
- CACHE\_SERVER session caching value 305
- caching
  - authentication\_cache\_size configuration
    - variable 45, 46
  - authentication\_cache\_timeout configuration
    - variable 45, 46
  - CACHE\_CLIENT session caching value 305
  - CACHE\_NONE session caching value 305
  - CACHE\_SERVER\_AND\_CLIENT session caching
    - value 305
  - CACHE\_SERVER session caching value 305
  - of credentials 45
  - SSL/TLS
    - cache size 305
    - validity period 305
- Caching sessions 305
- CAs 236
- ca utility 535
- CertConstraintsPolicy 401

- CertConstraintsPolicy policy 401
- certificate authority
  - and certificate signing 226
- certificate-based authentication 40
  - and HTTP 50
  - example scenario 66, 76, 102
  - file adapter, configuring 212
  - LDAP adapter, configuring 214
- certificate constraints policy
  - three-tier target server 101
- certificate\_constraints\_policy variable 276, 401
- Certificates
  - chain length 275
  - constraints 276, 401
- certificates
  - CertConstraintsPolicy policy 401
  - chaining 231
  - constraint language 276, 401
  - constraints policy 101
  - contents of 227
  - creating and signing 239
  - deployment, 247
  - importing and exporting 234
  - length limit 232
  - own, specifying 268
  - pass phrase 270
  - peer 231
  - PKCS#12 file 233
  - public key 227
  - public key encryption 296
  - security handshake 261, 265
  - self-signed 231, 238
  - serial number 227
  - signing 226, 240
  - signing request 239
  - trusted CA list 248, 267
  - X.509 226
- certificate signing request 239
  - common name 240
  - signing 240
- chaining of certificates 231
- ciper suites
  - order of 300
- cipher suites
  - ciphersuites configuration variable 300
  - compatibility algorithm 303
  - compatibility with association options 303
  - default list 300
  - definitions 297
  - effective 302
  - encryption algorithm 296
  - exportable 297
  - integrity-only ciphers 296
  - key exchange algorithm 296
  - mechanism policy 299
  - secure hash algorithm 296
  - secure hash algorithms 297
  - security algorithms 296
  - specifying 295
  - standard ciphers 296
- ciphersuites configuration variable 300
- CLASSPATH 396
- client\_binding\_list configuration variable
  - iSF, client configuration 92
  - secure client 85
- ClientCertificate attribute 57
- ClientPrivateKeyPassword attribute 57
- client secure invocation policy 302
  - HTTPS 287
  - IIOPTLS 287
- ClientSecureInvocationPolicy policy 283
- client\_version\_policy
  - IIOPT 466
- close() method 389
- cluster.properties file
  - example 188
- clustering
  - definition 179
  - is2.cluster.properties.filename property 187
  - is2.replica.selector.classname 187
  - IT\_SecurityService initial reference 190
  - load balancing 193
  - login service 186, 187
  - plugins:security:iioptls:addr\_list variable 190
  - plugins:security:iioptls:host variable 191
  - plugins:security:iioptls:port variable 191
  - policies:iioptls:load\_balancing\_mechanism variable 194
  - securityInstanceURL property 188
- cluster properties file 184
- colocated invocations
  - and secure associations 280
- colocation
  - incompatibility with principal propagation 308
- com.iona.isp.adapters property 394
- common names
  - uniqueness 240
- Confidentiality association option 285

- hints 293
  - Confidentiality option 285
  - configuration
    - and iSF standalone deployment 380
    - of the iSF adapter 394
    - plugins:java\_server:classpath configuration variable 396
  - Configuration file 537
  - connection\_attempts 466
  - constraint language 276, 401
  - Constraints
    - for certificates 276, 401
  - CORBA
    - action-role mapping file 217
    - action-role mapping file, example 217
    - and iSF client SDK 378
    - configuring principal propagation 309
    - intermediate server configuration 97
    - iSF, three-tier system 96
    - principal propagation 308
    - security, overview 82
    - SSL/TLS
      - client configuration 84
      - securing communications 84
    - three-tier target server configuration 99
  - CORBA binding
    - CSI authorization over transport 40
    - CSI identity assertion 40
    - protocol layers 42
    - SSO overview 110
  - CORBA Principal 39, 74
  - CORBA security
    - CSlv2 plug-in 83
    - GSP plug-in 83
    - IIOPTLS plug-in 83
  - CSI
    - authorization over transport 40
    - identity assertion 40
  - CSI interceptor 92
  - CSlv2
    - certificate constraints policy 101
    - principal sponsor
      - client configuration 93
  - CSlv2 plug-in
    - CORBA security 83
  - CSR 239
- D**
- data encryption standard
    - see DES
  - default\_password configuration value 310
  - DER 518
  - DES
    - symmetric encryption 297
  - DetectMisordering association option 285
    - hints 293
  - DetectMisordering option 285
  - DetectReplay association option 285
    - hints 293
  - DetectReplay option 285
  - Distinguished Encoding Rules 518
  - distinguished names
    - definition 519
  - DN
    - definition 519
    - string representation 519
  - domain name
    - ignored by iSF 91
  - domains
    - federating across 180
- E**
- effective cipher suites
    - definition 302
  - embedded deployment 381
    - loading an adapter class 396
  - enable\_principal\_service\_context configuration variable 309
  - encryption algorithm
    - RC4 297
  - encryption algorithms 296
    - DES 297
    - symmetric 297
    - triple DES 297
  - enterprise security service
    - and iSF security domains 203
  - EstablishTrustInClient association option 55, 56, 86, 286
    - hints 292
    - three-tier target server 100
  - EstablishTrustInClient option 286
  - EstablishTrustInTarget association option 286
    - hints 292
  - EstablishTrustInTarget option 286
  - exportable cipher suites 297



**F**

- failover
  - definition 185
- features, of the Artix security service 378
- federation
  - and the security service 180
  - cluster properties file 184
  - definition 179
  - is2.cluster.properties.filename property 183
  - is2.current.server.id property 180
  - is2.properties file 183, 187
  - plugins:security:iiop\_tls settings 184
- file adapter 167
  - configuring certificate-based authentication 212
  - properties 167
- file domain
  - <realm> tag 211
  - <users> tag 211
  - example 210
  - file location 210
  - managing 210

**G**

- generic server 380
- getAllUsers() method 391
- getAuthorizationInfo() method 390
- GroupBaseDN property 171
- GroupNameAttr property 171
- GroupObjectClass property 171
- GroupSearchScope property 172
- GSP plug-in
  - and security layer 43
  - and the login service 110
  - authentication\_cache\_size configuration variable 45
  - authentication\_cache\_timeout configuration variable 45
  - caching of credentials 45
  - CORBA security 83
- GSSUP credentials 182

**H**

- high availability 185
- HTTP
  - ASP security layer 49
  - security layers 48
- HTTP Basic Authentication 40, 50
  - overview 62

- HTTP-compatible binding
  - compatible bindings 49
  - overview 48
  - protocol layers 41
- HTTPS
  - ciphersuites configuration variable 300
  - client configuration 53, 55
  - mutual authentication 57
- HTTPS security
  - overview 51

**I**

- identity assertion 40
- IIOPTLS
  - ciphersuites configuration variable 300
- IIOPTLS plug-in
  - CORBA security 83
- IIOPT plug-in
  - and semi-secure clients 85
- IIOPT policies 461, 464
  - client version 466
  - connection attempts 466
  - export hostnames 471
  - export IP addresses 471
  - GIOP version in profiles 471
  - server hostname 470
  - TCP options
    - delay connections 472
    - receive buffer size 473
- IIOPT policy
  - ports 470
- IIOPT\_TLS interceptor 85
- index file 237
- initialize() method 389, 395
- Integrity association option 285
  - hints 293
- integrity-only ciphers 296
- Integrity option 285
- interceptors
  - artix security 64
  - bus-security 116
  - login\_client 115
- interoperability
  - explicit principal header 316
  - with .NET 315
  - with Orbix applications 308
- invocation policies
  - interaction with mechanism policy 291
- IONAGlobalRealm 391

- IONAGlobalRealm realm 209
  - IONAUserRole 220
  - is2.cluster.properties.filename property
    - and clustering 187
    - and federation 183
  - is2.current.server.id property 180
    - and clustering 187
  - is2.properties file 167
    - and clustering 187
    - and federation 183, 187
    - and iSF adapter configuration 382
  - IS2AdapterException class 390
  - IS2Adapter Java interface 382
    - implementing 383
  - iS2 adapters
    - file domain
      - managing 210
    - LDAP domain
      - managing 214
    - standard adapters 378
  - iSF
    - action\_role\_mapping configuration variable 94
    - and certificate-based authentication 102
    - authorization realm
      - setting in server 94
    - client configuration
      - CSI interceptor 92
    - CORBA
      - three-tier system 96
      - three-tier target server configuration 99
      - two-tier scenario description 91
    - CORBA security 82
    - domain name, ignoring 91
    - intermediate server configuration 97
    - security domain
      - creating 204
    - server configuration
      - server\_binding\_list 92
    - server\_domain\_name configuration variable 94
    - three-tier scenario description 97
    - user account
      - creating 204
  - iSF adapter
    - adapter class property 394
    - and IONAGlobalRealm 391
    - and the iSF architecture 378
    - authenticate() method 389
    - close() method 389
    - com.iona.isp.adapters property 394
    - configuring to load 394
    - custom adapter, main elements 382
    - example code 383
    - getAllUsers() method 391
    - getAuthorizationInfo() method 390
    - initialize() method 389, 395
    - logout() method 392
    - overview 382
    - property format 395
    - property truncation 395
    - WRONG\_NAME\_PASSWORD minor
      - exception 390
  - iSF adapters
    - enterprise security service 203
  - iSF adapter SDK
    - and the iSF architecture 378
  - iSF client
    - in iSF architecture 377
  - iSF client SDK 378
  - iSF server
    - plugins:java\_server:classpath configuration
      - variable 396
  - IT\_SecurityService initial reference 190
- ## J
- J2EE
    - and iSF client SDK 378
  - JCE architecture
    - enabling 417
- ## K
- kdc property 176
  - Kerberos 175
    - token 39
  - Kerberos adapter
    - Kerberos KDC server 176
    - properties 175
  - Kerberos property
    - RetrieveAuthInfo 177
  - Kerberos Realm Name property 176
  - key exchange algorithms 296
- ## L
- LDAP adapter 169
    - basic properties 172
    - configuring certificate-based authentication 214
    - GroupBaseDN property 171
    - GroupNameAttr property 171

- GroupObjectClass property 171, 172
- LDAP server replicas 173
- MemberDNAttr property 172
- PrincipalUserDN property 174
- PrincipalUserPassword property 174
- properties 170
- replica index 173
- RoleNameAttr property 171
- SSLCACertDir property 174
- SSLClientCertFile property 174
- SSLClientCertPassword property 174
- SSLEnabled property 174
- UserBaseDN property 171
- UserNameAttr property 171
- UserObjectClass property 171
- UserRoleDNAttr property 171
- LDAP database
  - and clustering 186
- LDAP domain
  - managing 214
- Lightweight Directory Access Protocol
  - see LDAP
- load balancing 186
  - and clustering 193
  - policies:iiop\_tls:load\_balancing\_mechanism variable 194
- local\_hostname 470
- log4j 199
  - documentation 199
- logging
  - in secure client 54, 86
  - log4j 199
- login\_client:login\_client interceptor 115
- login\_client plug-in 115
  - and the login service 110
- login service
  - and single sign-on 110
  - standalone deployment 111
  - WSDL contract for 117
- login\_service plug-in
  - configuring 117
- logout() method 392

**M**

- max\_chain\_length\_policy configuration variable 275
- MD5 285, 297
- mechanism policy
  - interaction with invocation policies 291
- MechanismPolicy 285

- mechanism policy 299
- MemberDNAttr property 172
- message digest 5
  - see MD5
- message digests 285
- message fragments 285
- MESSAGE\_LEVEL security level 117
- mixed configurations, SSL/TLS 88
- multi-homed hosts, configure support for 470
- multiple CAs 232
- mutual authentication 264
  - HTTPS 57

**N**

- namespace
  - plugins:csi 418
  - plugins:gsp 419
  - policies 445
  - policies:csi 457
  - policies:https 461
  - policies:iiop\_tls 463
  - principal\_sponsor:csi 480
  - principle\_sponsor 476, 483
- no\_delay 472
- NoProtection association option
  - rules of thumb 291
- NoProtection association option 89, 285
  - hints 293
  - semi-secure applications 294
- NoProtection option 285

**O**

- opage Abstract Syntax Notation One
  - see ASN.1 517
- OpenSSL 230, 527
- openssl
  - configuration file 537
  - utilities 528
- openssl.cnf example file 541
- OpenSSL command-line utilities 235
- Orbit configuration file 380
- ORBname argument 220
- orb\_plugins configuration variable 85
  - client configuration 92
- orb\_plugins variable
  - and the NoProtection association option 293
  - semi-secure configuration 294

**P**

- pass phrase 270
  - dialog prompt, C++ 270
  - in configuration 271
  - password file, from 270
- Password attribute 63
- peer certificate 231
- performance
  - caching of credentials 45
- PKCS#12 files
  - creating 234, 239
  - definition 233
  - importing and exporting 234
  - pass phrase 270
  - viewing 234
- plug-ins
  - CSlv2, in CORBA security 83
  - GSP, in CORBA security 83
  - IIOp 85
  - IIOp/TLS, in CORBA security 83
- plugins:asp:default\_password configuration variable 77
- plugins:asp:security\_level 411
- plugins:asp:security\_level configuration variable 64
- plugins:csi:ClassName 418
- plugins:csi:shlib\_name 418
- plugins:gsp:authorization\_realm 420
- plugins:gsp:ClassName 421
- plugins:iioptcp\_listener:reincarnate\_attempts 431
- plugins:iioptcp\_listener:reincarnation\_retry\_backoff\_ratio 431
- plugins:iioptcp\_listener:reincarnation\_retry\_delay 431
- plugins:iioptls:hfs\_keyring\_file\_password 467
- plugins:iioptls:tcp\_listener:reincarnation\_retry\_backoff\_ratio 431
- plugins:iioptls:tcp\_listener:reincarnation\_retry\_delay 431
- plugins:java\_server:classpath configuration variable 396
- plugins:login\_client:wSDL\_url configuration variable 115
- plugins:login\_service:wSDL\_url configuration variable 117
- plugins:security:iioptls:addr\_list variable and clustering 190
- plugins:security:iioptls:host variable 191
- plugins:security:iioptls:port variable 191
- plugins:security:iioptls settings 184
- POA\_Coloc interceptor 308
- policies:max\_chain\_length\_policy 447
- policies
  - CertConstraintsPolicy 401
  - client secure invocation 302
  - ClientSecureInvocationPolicy 283
  - HTTPS
    - client secure invocation 287
    - target secure invocation 289
  - IIOp/TLS
    - client secure invocation 287
    - target secure invocation 289
  - target secure invocation 302
  - TargetSecureInvocationPolicy 283
- policies:allow\_unauthenticated\_clients\_policy 445
- policies:asp:enable\_authorization configuration variable 64
- policies:certificate\_constraints\_policy 446
- policies:csi:attribute\_service:client\_supports 457
- policies:csi:attribute\_service:target\_supports 458
- policies:csi:auth\_over\_transport:target\_supports 459
- policies:csi:auth\_over\_transport:client\_supports 458
- policies:csi:auth\_over\_transport:target\_requires 459
- policies:https:mechanism\_policy:ciphersuites 462
- policies:https:mechanism\_policy:protocol\_version 462
- policies:https:trusted\_ca\_list\_policy 463
- policies:iioptls:allow\_unauthenticated\_clients\_policy 465
- policies:iioptls:certificate\_constraints\_policy 465
- policies:iioptls:client\_secure\_invocation\_policy:requires 466
- policies:iioptls:client\_secure\_invocation\_policy:supports 466
- policies:iioptls:client\_version\_policy 466
- policies:iioptls:connection\_attempts 466
- policies:iioptls:connection\_retry\_delay 467
- policies:iioptls:load\_balancing\_mechanism variable 194
- policies:iioptls:max\_chain\_length\_policy 467
- policies:iioptls:mechanism\_policy:ciphersuites 468
- policies:iioptls:mechanism\_policy:protocol\_version 469
- policies:iioptls:server\_address\_mode\_policy:local\_hostname 470
- policies:iioptls:server\_address\_mode\_policy:port\_range 470
- policies:iioptls:server\_address\_mode\_policy:publish

- \_hostname 471
- policies:iiop\_tls:server\_version\_policy 471
- policies:iiop\_tls:session\_caching\_policy 471
- policies:iiop\_tls:target\_secure\_invocation\_policy:req  
    uires 472
- policies:iiop\_tls:target\_secure\_invocation\_policy:sup  
    ports 472
- policies:iiop\_tls:tcp\_options:send\_buffer\_size 473
- policies:iiop\_tls:tcp\_options\_policy:no\_delay 472
- policies:iiop\_tls:tcp\_options\_policy:recv\_buffer\_size  
    473
- policies:iiop\_tls:trusted\_ca\_list\_policy 473
- policies:mechanism\_policy:ciphersuites 448
- policies:mechanism\_policy:protocol\_version 449
- policies:session\_caching\_policy 449
- policies:target\_secure\_invocation\_policy:requires 45  
    0
- policies:target\_secure\_invocation\_policy:supports 4  
    50
- policies:trusted\_ca\_list\_policy 451  
    540
- Principal 39
- principals
  - and colocation 308
  - configuring propagation 309
  - explicit principal header 316
  - from O/S username 309
  - interoperability 308
  - interoperating with .NET 315
  - overview 308
  - reading on the server side 314
  - setting on the client side 312
- principal sponsor
  - CSiv2
    - client configuration 93
    - SSL/TLS
      - enabling 59, 88
      - SSL/TLS, disabling 54, 56, 86
  - principal\_sponsor:csi:auth\_method\_data 481
  - principal\_sponsor:csi:use\_principal\_sponsor 480
  - principal\_sponsor Namespace Variables 476, 483
  - PrincipalUserDN property 174
  - PrincipalUserPassword property 174
  - principle\_sponsor:auth\_method\_data 477, 484
  - principle\_sponsor:auth\_method\_id 477, 484
  - principle\_sponsor:callback\_handler:ClassName 479
  - principle\_sponsor:login\_attempts 479
  - principle\_sponsor:use\_principle\_sponsor 476, 483
- private key 238

- protocol\_version configuration variable 299
- public key encryption 296
- public keys 227
- publish\_hostname 471

## R

- RC4 encryption 297
- RDN 521
- realm
  - see authorization realm
- realm property 176
- realms
  - IONAGlobalRealm, adding to 391
- recv\_buffer\_size 473
- relative distinguished name 521
- Replay detection 285  
    538
- REQUEST\_LEVEL security level 116
- req utility 531
- req Utility command 531
- Rivest Shamir Adleman
  - see RSA
- role-based access control 205  
    example 208
- RoleNameAttr property 171
- role-properties file 221
- roles
  - creating 207
  - special 209
- root certificate directory 232
- RSA 296
  - symmetric encryption algorithm 297
- RSA\_EXPORT\_WITH\_DES40\_CBC\_SHA cipher  
    suite 296, 303
- RSA\_EXPORT\_WITH\_RC4\_40\_MD5 cipher  
    suite 296, 303
- rsa utility 533
- rsa Utility command 533
- RSA\_WITH\_3DES\_EDE\_CBC\_SHA cipher  
    suite 296, 303
- RSA\_WITH\_DES\_CBC\_SHA cipher suite 296, 303
- RSA\_WITH\_NULL\_MD5 cipher suite 296, 303
- RSA\_WITH\_NULL\_SHA cipher suite 296, 303
- RSA\_WITH\_RC4\_128\_MD5 cipher suite 296, 303
- RSA\_WITH\_RC4\_128\_SHA cipher suite 296, 303

## S

- Schannel toolkit

- selecting for C++ applications 407
- secure associations
  - client behavior 287
  - definition 280
  - TLS\_Coloc interceptor 280
- secure hash algorithms 296, 297
- security algorithms
  - and cipher suites 296
- security domain
  - creating 204
- security domains
  - architecture 203
  - iSF 204
- security handshake
  - cipher suites 295
  - SSL/TLS 261, 265
- security information file 167
- securityInstanceURL property 188
- security layer
  - overview 43
- security levels
  - MESSAGE\_LEVEL 117
  - REQUEST\_LEVEL 116
- security service
  - federation of 180
- security\_type configuration variable 310
- self-signed CA 238
- self-signed certificate 231
- semi-secure applications
  - and NoProtection 294
- send\_principal configuration variable 309
- serial file 237
- serial number 227
- server\_binding\_list configuration variable 92
- ServerCertificate attribute 61
- server\_domain\_name configuration variable
  - iSF, ignored by 94
- ServerPrivateKeyPassword attribute 61
- server\_version\_policy
  - IIOp 471
- session\_cache\_size configuration variable 305
- session\_cache\_validity\_period configuration variable 305
- session\_caching\_policy configuraion variable 305
- session\_caching\_policy variable 305
- session idle timeout
  - SSO 112
- session timeout
  - SSO 112
- SHA 297
- SHA1 285
- signing certificates 226
- Single sign-on
  - and security layer 43
- single sign-on
  - SSO token 40
  - token timeouts 112
- SOAP
  - principal propagation 308
- SOAP binding
  - ASP security layer 73
  - configuring principal propagation 309
  - protocol layers 42, 72
  - SOAP protocol layer 73
  - SSO overview 110
- Specifying ciphersuites 295
- SSL/TLS
  - association options
    - setting 282
  - caching validity period 305
  - cipher suites 295
  - client configuration 84
  - colocated invocations 280
  - encryption algorithm 296
  - IIOp\_TLS interceptor 85
  - key exchange algorithm 296
  - logging 54, 86
  - mechanism policy 299
  - mixed configurations 88
  - orb\_plugins list 85
  - principal sponsor
    - disabling 54, 56, 86
    - enabling 59, 88
  - protocol\_version configuration variable 299
  - secure associations 280
  - secure hash algorithm 296
  - secure hash algorithms 297
  - securing communications 84
  - security handshake 261, 265
  - selecting a toolkit, C++ 407
  - semi-secure client
    - IIOp plug-in 85
  - session cache size 305
  - TLS session 280
- SSLCACertDir property 174
- SSLClientCertFile property 174
- SSLClientCertPassword property 174
- SSLeay 230

SSLEnabled property 174  
 SSO  
   advantages 111  
   CORBA binding 110  
   login\_client plug-in 115  
   login\_service WSDL 117  
   sample configurations 119  
   session idle timeout 112  
   session timeout 112  
   SOAP binding 110  
   username/password-based authentication 114  
   \_SSO\_TOKEN\_ 114  
 SSO token 40  
   and the login service 110  
   automatic refresh 112  
   timeouts 112  
 standalone deployment 380  
 standard ciphers 296  
 symmetric encryption algorithms 297

## T

Target  
   choosing behavior 289  
 target authentication 261  
 target secure invocation policy 302  
   HTTPS 289  
   IIOP/TLS 289  
 TargetSecureInvocationPolicy policy 283  
 TCP policies  
   delay connections 472  
   receive buffer size 473  
 three-tier scenario description 97  
 TLS\_Coloc interceptor 280  
 TLS security  
   and HTTP 48  
 TLS session  
   definition 280  
 toolkit replaceability  
   enabling JCE architecture 417  
   selecting the toolkit, C++ 407  
 triple DES 297  
 truncation of property names 395  
 trusted CA list 248  
 trusted CA list policy 267  
 trusted CAs 232  
 TrustedRootCertificates attribute 61

## U

use\_jsse\_tk configuration variable 417  
 user account  
   creating 204  
 UserBaseDN property 171  
 username/password-based authentication  
   overview 113  
   SSO 114  
 UserName attribute 63  
 UserNameAttr property 171  
 UserObjectClass property 171  
 UserRoleDNAttr property 171  
 UserSearchScope property  
   LDAP adapter  
     UserObjectClass property 171  
 UseSecureSockets attribute 60  
 utilities  
   wsdltoacl 220

## V

Variables 538, 539, 540

## W

Web service security extension  
   opage see WSSE 39  
 WRONG\_NAME\_PASSWORD minor exception 390  
 wsdltoacl utility 220  
   role-properties file 221  
 WSSE  
   Kerberos token 39  
   UsernameToken 39  
 WSSE Kerberos credentials 74  
 WSSE UsernameToken credentials 74  
 WSSEUsernameToken property 360, 362, 365,  
   368, 370  
 WSSEX509Cert property 370, 372

## X

X.500 517  
 X.509  
   public key encryption 296  
 X.509 certificate  
   definition 226  
 X.509 certificates 225  
 x509 utility 529

