



COBOL Analyzer 7.0

Installation Guide

Micro Focus
The Lawn
22-30 Old Bath Road
Newbury, Berkshire RG14 1QN
UK
<http://www.microfocus.com>

© Copyright 2009-2021 Micro Focus or one of its affiliates.

MICRO FOCUS, the Micro Focus logo and **COBOL Analyzer** are trademarks or registered trademarks of Micro Focus or one of its affiliates.

All other marks are the property of their respective owners.

2021-07-29

Contents

Overview	4
Installation Tasks	4
Deployment	4
Mainframe and Network Server	5
Repository Server	5
CA Server	5
CA Client	5
Single User Installation	5
Database Setup	6
SQL Server Database Setup	6
Hardware and Software Requirements	8
Repository Server Hardware Requirements	8
Repository Server Software Requirements	8
CA Server Hardware Requirements	8
CA Server Software Requirements	9
CA Client Hardware Requirements	9
CA Client Software Requirements	10
CA Performance Optimization Guidelines	11
Choosing Hardware Configuration	11
Single User (One Machine)	11
Enterprise Installation (Multiple Users Using Separate Database Server)	12
Software Configuration	15
Verification Information	15
Parallel Verification	15
Choosing the Optimal Number of Queue Processors	15
Using More Computers	16
Installing and Uninstalling COBOL Analyzer	17
Installing CA on the Server or Client	17
Uninstalling COBOL Analyzer	17
Post-Installation Administrative Tasks	18
Configuring COBOL Analyzer	18
Licensing	18
Upgrading Customers	18
Concurrent Use	19
COBOL Analyzer Licensing	19
Business Rule Manager Licensing	19
Micro Focus End User License Agreement	19
Additional License Authorizations for Visual COBOL & Enterprise software products	28
Creating a Shared Folder for Workspaces	39
Upgrading Workspaces	40
Troubleshooting the Installation	41
Troubleshooting Workspace Access	41

Overview

This manual describes how to install and configure Micro Focus COBOL Analyzer (CA), a suite of software products for analyzing and modernizing legacy applications.

COBOL Analyzer provides insight into the technical reality of complex application portfolios, including

- Tools for application and program level understanding, utilizing extensive metrics, reports, diagrammatic views and querying tools to support myriad of business initiatives.
- Quality Assessment with standard code quality queries to serve as a guidance to a code quality practice in both development and maintenance phases.
- Portability Assessment to help you generate various HTML reports to identify points of interest for migrations.
- In depth analysis tools to promote efficiency in the performance of daily tasks such as field changes, understanding of data propagation through a program, and dead code removal.

Business Rule Manager mines business logic from program code and encapsulates the logic in business rules.

While all products are installed with COBOL Analyzer, each product is licensed separately.

CA can be deployed in a multi-user environment or single users with a local database. The multi-user environment gives users access to a common repository of application objects. Repository setup is the responsibility of a master user, leaving team members free to focus on their tasks. The database for the repository is assumed to be the customer's own.

CA installations consist of the following components:

- The CA Server which hosts CA workspace files and related support files.
- CA Clients which host the link files used to connect to workspaces on the server.
- For single user setups, the CA software is installed on the developer's machine and includes an option to install a local database.

This manual also describes how to install and configure the database client used to connect to repositories, for sites at which the database client is not already installed. If you store repositories in Oracle or DB2, a database client must be installed wherever the CA client or CA server is installed.

Installation Tasks

The table below describes the tasks involved in installing COBOL Analyzer and the order in which the tasks must be performed.

Task	Order	Notes
Install CA on Server	1	This is for multi-user environments only.
Install CA on Clients	2	The CA package optionally installs SQL Server Express. This is enough for a small sized repository (up to 10 GB).

Each task is described and explained in the chapters of the *Installation Guide*.

Deployment

The figure below shows the standard CA deployment scenario. The role each machine performs and its key relationships are described in the following sections.

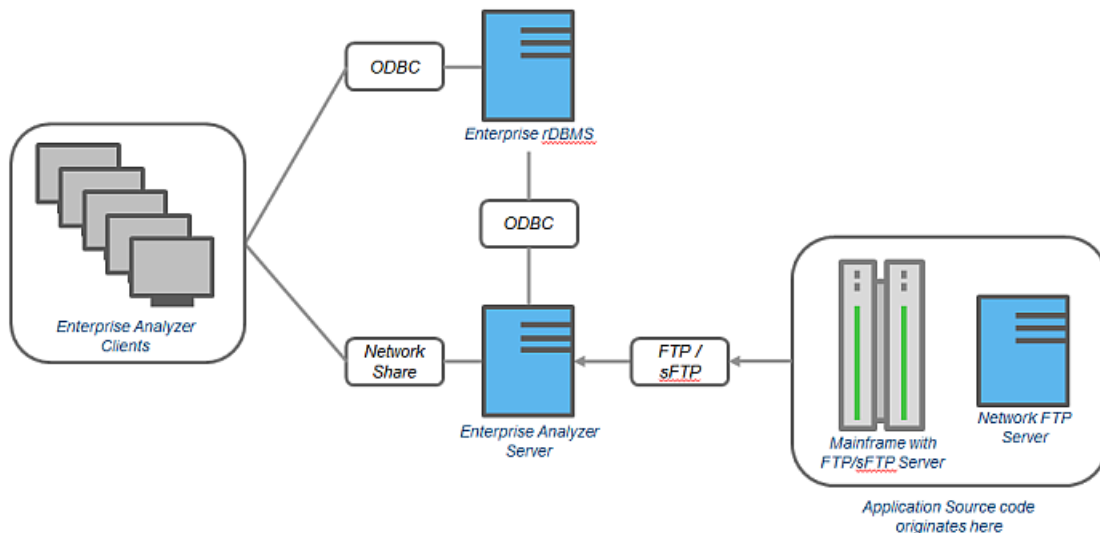

Mainframe and Network Server

The mainframe typically hosts the application to be modeled in CA. Application source files are downloaded from the mainframe (and, if necessary, a network server) to the CA server via FTP or SFTP.

Repository Server

The Repository Server hosts the database for one or more multiuser repositories, one repository per CA workspace. This server provides centralized, network-accessible storage for parsed data and analysis output.

CA Server

The CA Server hosts workspaces, workspace support files (including the copies of application source files CA creates at workspace loading), and workspace output. This server leverages multiple processes to enhance parsing performance in online or batch mode.

Parsed data is sent via ODBC to the repository server. Some analysis output is stored on the CA server as well.

 **Note:** In a multi-user environment, the CA Server cannot reside on the same machine as the CA Repository. The installation program is the same for the CA client and CA server.

CA Client

CA Clients host the link files that let team members connect to workspaces on the CA server. These clients access repository data stored in the repository server via ODBC.

 **Note:** The installation program is the same for the CA client and CA server.

Single User Installation

You can configure COBOL Analyzer to build a workspace on one machine for a single user. You can use Microsoft SQL Server Express - installed by default - to create a workspace on your local machine. CA creates a database for the workspace "on the fly," with no intervention on your part. If you do use SQL Server Express, bear in mind that the Windows user who creates the workspace must have been configured with appropriate permissions in SQL Server Express. The user who installed SQL Server

Express will always have the appropriate permissions. See the SQL Server Express documentation for configuration instructions.



Restriction: The database size limit when using the SQL Server Express option is 10 GB.

Database Setup

If you use Microsoft SQL Server, the DBA must set up a SQL Server database for each workspace repository you plan to create. CA users typically supply Windows credentials to access the repository.

SQL Server Database Setup

If you use Microsoft SQL Server, you must set up a SQL Server database for each workspace repository you plan to create. If CA users will connect to the repository through a SQL Server login account, make sure the server authentication property is set to **SQL Server and Windows Authentication mode**, as described below.

The following instructions assume you are using the SQL Server Management Studio tool for SQL Server 2008. The procedure for the SQL Server Management Studio Express tool for SQL Server 2005 is similar.



Note: For Windows XP installations using the Italian locale, you must set the Time format in the Control Panel Regional Language Options to "HH:mm:ss" before attempting to verify an CA workspace with a SQL Server repository. Click **Settings > Control Panel > Regional and Language Options > Customize > Time** and choose "HH:mm:ss" from the **Time format** drop-down.

1. Choose **Start > Programs > Microsoft SQL Server 2008 > SQL Server Management Studio**.
2. In the Connect to Server screen, select:
 - Database engine in the **Server type** drop-down.
 - The server on which you want to create the repository database in the **Server name** drop-down.
 - Windows Authentication in the **Authentication** drop-down.
3. Click **Connect**. The Microsoft SQL Server Management Studio window opens. In the Object Explorer pane, expand the folder for the server. Click Databases and choose **New Database...** from the right-click menu. The New Database window opens.
4. Select the General page. In the **Database name** field, enter the name of the database for the repository. Modify the logical name and initial sizes of the database and log files if needed, then click **OK**. The new database is displayed in the Object Explorer pane.
 **Note:** Check the SQL Server Management Studio documentation for details on other database settings.
5. If CA users will connect to the workspace repository through a Windows user account, skip the remaining steps. If CA users will connect to the workspace repository through an SQL Server login account, click the server name in the Object Explorer pane and choose **Properties** from the right-click menu. The Server Properties window opens.
6. Select the Security page. In the Server authentication area, select **SQL Server and Windows Authentication mode**, then click **OK**.
7. In the Object Explorer pane, click **Security > Logins** and choose **New Login...** from the right-click menu. The Login - New window opens.
8. Select the General page. In the **Login name** field, enter the database login name, then choose **SQL Server authentication**. Enter the password for the database login in the **Password** and **Confirm password** fields, then click **OK**. The new login is displayed in the Object Explorer pane.
9. In the Object Explorer pane, expand the database you created for the workspace repository. Click **Security > Users** and choose **New User...** from the right-click menu. The Database User - New window opens.

10. Select the General page. Define the database user:

- In the **User name** field, enter the database user name.
- In the **Login name** field, enter the database login name. Use the browse button to browse for the login name.



Note: You specify the login name, not the database user name, when you create or connect to a workspace, so it is usually best to make the user name and login name the same.

- In the Database role membership pane, check db_owner, then click **OK**. The new user is displayed in the Object Explorer pane.



Tip: You can use the same login and database user for multiple databases/workspaces.

You can configure COBOL Analyzer to build a workspace on one machine for a single user. You can use Microsoft SQL Server Express - installed by default - to create a workspace on your local machine. CA creates a database for the workspace "on the fly," with no intervention on your part. If you do use SQL Server Express, bear in mind that the Windows user who creates the workspace must have been configured with appropriate permissions in SQL Server Express. The user who installed SQL Server Express will always have the appropriate permissions. See the SQL Server Express documentation for configuration instructions.



Restriction: The database size limit when using the SQL Server Express option is 10 GB.

Hardware and Software Requirements

The following sections describe the hardware, disk space, operating system, and software requirements for CA installations.

Repository Server Hardware Requirements

The table below lists the hard drive storage requirements for the Repository Server. For other hardware recommendations, check with support services.

Type	Requirement	Notes
Hard Drive Storage	Variable	Minimum of 20 GB disk space needed for the software installation of the RDBMS and the CA template database. Plus approximately 60x the size in bytes of the application source code modeled in CA (e.g., 100 MB source = 6 GB).

Repository Server Software Requirements

The table below lists the software requirements for the Repository Server.

Type	Requirement
SQL Server	MS SQL Server 2012, 2014, 2016, 2017 or 2019
PostgreSQL	PostgreSQL 13



CA Server Hardware Requirements

The table below lists the hardware requirements for CA Server installations. Hardware requirements may vary depending on the size of the application you are analyzing.

Type	Requirement	Notes
Processor	2.6 GHz Dual Core or 2x 3.0+ GHz Processors	Dual processing capability with multiple cores in a processor or separate physical processors.
Physical Memory	3 GB RAM	
Virtual Memory	1 GB to 3 GB	
Hard Drive Storage	Variable	For CA workspaces, approximately 40x size in bytes of the application source code modeled in CA (for example, 100 MB source = 4 GB). For CA software, minimum 200 MB.

CA Server Software Requirements

The table below lists the software requirements for CA Server installations.

Type	Requirement
Operating System	<p>Microsoft Windows Server 2012, 32-bit and 64-bit</p> <p>Microsoft Windows Server 2016, 64-bit</p> <p>Microsoft Windows Server 2019, 64-bit</p> <p>Microsoft Windows 10, 32-bit and 64-bit</p>
Pre-requisite Software	<p> Note: The pre-requisite software is automatically installed by the installer.</p> <ul style="list-style-type: none"> • Sentinel RMS License Manager • .NET Framework 4.0 • .NET Framework 4.6.1 • Visual C++ 2012 Redistributable 11.0.61030 • Visual C++ 2017 Redistributable 14.11.25325.0 • SQL Server 2014 Express (optional install)
Web browser	<p>Required to view HTML report outputs or to access the Web client.</p> <ul style="list-style-type: none"> • Internet Explorer 6.0 or higher (optional) • Mozilla Firefox 3.6 or higher • Chrome 6 or higher
Microsoft Office (optional)	<p>Required by CA tools with reporting capabilities to save to Microsoft Office file formats. Excel is required for standard deviation charts in the Executive Report.</p>
Microsoft Visio (optional)	<p>Required to generate output as Microsoft Visio files.</p> <p> Note: When the Visio version is 2013 or higher, the .VSDX format is used instead of .VSD.</p>
OpenJDK JRE 8.0 or higher (optional)	<p>Required for Java parsing.</p>



CA Client Hardware Requirements

The table below lists the hardware requirements for CA Client installations. Hardware requirements may vary depending on the size of the application you are analyzing.

Type	Requirement	Notes
Processor	3.0 GHz Processor	Single processor (single or dual core).
Physical Memory	1GB RAM	
Virtual Memory	1GB to 3GB	
Hard Drive Storage	Variable	For CA software, minimum 200MB.

CA Client Software Requirements

The table below lists the software requirements for CA Client installations.

Type	Requirement
Operating System	<p>Microsoft Windows Server 2012, 32-bit and 64-bit</p> <p>Microsoft Windows Server 2016, 64-bit</p> <p>Microsoft Windows Server 2019, 64-bit</p> <p>Microsoft Windows 10, 32-bit and 64-bit</p>
Pre-Requisite Software	<p> Note: The pre-requisite software is automatically installed by the installer.</p> <ul style="list-style-type: none"> • Sentinel RMS License Manager • .NET Framework 4.0 • .NET Framework 4.6.1 • Visual C++ 2012 Redistributable 11.0.61030 • Visual C++ 2017 Redistributable 14.11.25325.0 • SQL Server 2014 Express (optional install)
Web browser	<p>Required to view HTML report outputs or to access the Web client.</p> <ul style="list-style-type: none"> • Internet Explorer 6.0 or higher (optional) • Mozilla Firefox 3.6 or higher • Chrome 6 or higher
Microsoft Office (optional)	<p>Required by CA tools with reporting capabilities to save to Microsoft Office file formats. Excel is required for standard deviation charts in the Executive Report.</p>
Microsoft Visio (optional)	<p>Required to generate output as Microsoft Visio files.</p> <p> Note: When the Visio version is 2013 or higher, the .VSDX format is used instead of .VSD.</p>
OpenJDK JRE 8.0 or higher (optional)	<p>Required for Java parsing.</p>

CA Performance Optimization Guidelines

This section describes the optimal performance environments in which to run COBOL Analyzer, including selecting the right hardware configuration for specific types of usage, and optimizing the CA configuration for the selected configuration. The suggestions for performance improvements are focused on the repository build phase of the workspace.

The most time-consuming and hardware-intensive aspects of running COBOL Analyzer are the source verification and database loading during the workspace build phase. The guidelines include suggestions for improving performance by using multiple Queue Processors and taking advantage of multiple CPU cores, using the parallel verification option which determines the number of used Queue Processors, and guidelines for defining the number of Queue Processors needed for a given configuration of available machines and database server power.

There are two deployment scenarios for COBOL Analyzer:

- Single User - this is typically a mobile user, such as a consultant on a laptop, who uses the repository for demonstration or assessment purposes.
- Enterprise Installations - several computers are used (one for a database server, one for workspace and multiple user machines).

Choosing Hardware Configuration

Single User (One Machine)

Minimum Hardware Requirements

Type	Requirement	Notes
Processor	1.8 GHz, minimum dual core	
Physical Memory	2 GB RAM	
Hard Drive Storage	HDD with at least 20 GB free space	For CA workspaces, approximately 60x size in bytes of the application source code modeled in CA (for example, 100 MB source = 6 GB).

With this minimum hardware configuration you can run COBOL Analyzer and analyze sources.

Suggested Upgrades

The analysis time increases when the number of analyzed sources rises. To reduce the analysis time we recommend you use one of the suggested upgrades:

1. A high speed Solid State Drive (SSD) for storing database tables. This can be added as an external drive; however USB 3.0 or eSATA must be used. This will improve the verification performance by 25% over the minimum configuration.
2. Use a quad core processor such as Intel Core i7 2670QM or any other quad core QE/QM processor. This improves the verification performance by 50% over the minimum system configuration.



Note: You must run additional Queue Processors to benefit from the additional cores. See the *Choosing the Optimal Amount Of Queue Processors* section for details.



Note: Improved verification performance means that if the project verification takes 100 minutes, and you get 33% performance improvement, the verification time is reduced to 67 minutes.

Recommended Configuration 1

This configuration gives 33% improved verification performance. The changes from the minimum configuration are marked in bold.

Type	Requirement	Notes
Processor	2.0 GHz, 2 cores	
Physical Memory	4 GB	
Hard Disk Drive	SSD with at least 20 GB free space	For CA workspaces, approximately 60x size in bytes of the application source code modeled in CA (for example, 100 MB source = 6 GB).

Recommended Configuration 2

Recommended Configuration 2 gives 50% improved performance of verification. The changes from the minimum configuration are marked in bold.

Type	Requirement	Notes
Processor	2.0 GHz, 4 cores	
Physical Memory	4 GB	
Hard Disk Drive	Any type with at least 20 GB free space	For CA workspaces, approximately 60x size in bytes of the application source code modeled in CA (for example, 100 MB source = 6 GB).

Performance Configuration

The Performance Configuration is a combination of all upgrades. It gives 66% improved verification performance. The changes from the minimum configuration are marked in bold.

Type	Requirement	Notes
Processor	2.0 GHz, 4 cores	
Physical Memory	4 GB	
Hard Disk Drive	SSD with at least 20 GB free space	For CA workspaces, approximately 60x size in bytes of the application source code modeled in CA (for example, 100 MB source = 6 GB).

Enterprise Installation (Multiple Users Using Separate Database Server)

A typical environment where large projects will be verified on a regular basis usually consists of 3 types of components:

1. Database server (MS SQL Server).

- CA server with the workspace files. This is the machine where CA is installed and where the CA workspace folder is located.

 **Note:** There can be more than one workspace.

- Processing node(s). This is one or more computers running Queue Processors, or hosting the users of the tool.

Database Server

Minimum hardware requirements

Type	Requirement	Notes
Processor	2.6 GHz Dual Core or 2x 3.0+ GHz Processors	Dual processing capability with multiple cores in a processor or separate physical processors.
Physical Memory	3 GB RAM	
Hard Disk Drive		For CA workspaces, approximately 60x size in bytes of the application source code modeled in CA (for example, 100 MB source = 6 GB).

The minimum configuration can be up to four concurrent Queue Processors while providing reasonable response time. To improve performance, one of the following upgrades should be used:

- Use faster storage, for example use SSD or storage arrays in RAID0. SSD improves the performance of verification by 33%. 2x SCSI 15000 rpm gives a similar performance improvement.
- Use 8 GB of RAM. Increasing the amount of RAM improves the performance of verification by 15% when using more Queue Processors.
- Network latency between database server and repository server and users should be less than 1ms.

Recommended hardware configuration

This is the recommended hardware configuration. The changes from the minimum configuration are marked in bold.

Type	Requirement	Note
Processor	2.6 GHz Dual Core or 2x 3.0+ GHz Processors	Dual processing capability with multiple cores in a processor or separate physical processors.
Physical Memory	8 GB RAM	
Hard Disk Drive	SSD or SCSI 15000 rpm in RAID0	For CA workspaces, approximately 60x size in bytes of the application source code modeled in CA (for example, 100 MB source = 6 GB).

Performance Configuration

You get 33% improved performance of verification.

Type	Requirement	Note
Processor	Xeon CPU E5310 or Core i7 3770	
Physical Memory	8 GB	

Type	Requirement	Note
Hard Disk Drive	2x SCSI 15000 rpm RAID0 or 240GB SSD	

 **Note:** Performance configuration can support up to 16 concurrent Queue Processors. Note that user activity through the online tool should be counted as an active Queue Processor.

CA and Workspace Server

The repository server stores the COBOL Analyzer workspace folder and files. It is shared on the network so that other users can access it.

 **Warning:** Micro Focus does not recommend combining the CA server and database server (and even processing node) for machines with limited resources.

Minimum hardware requirements for Repository Server are:

Type	Requirement	Note
Hard Disk Drive	Minimum of 20 GB disk space needed for the software installation of the database software.	For CA workspaces, approximately 60x size in bytes of the application source code modeled in CA (for example, 100 MB source = 6 GB). Storing your workspace on an SSD drive improves verification performance by 5%-15%, depending on your project.

Processing Node/Nodes

This is the machine that runs the Queue Processors and the processes that they kick off. The minimum configuration lets you run a single Queue Processor.

Minimum System Requirements

Type	Requirement
Processor	3.0 GHz single core or 2 GHz dual core
Physical Memory	2 GB
Virtual Memory	1 GB to 3 GB
Hard Disk Drive	1 GB

The minimum system lets you analyze small volumes of sources and use the basic functionality of the tool. To determine the optimal amount of Queue Processors for your Processing node see *Choosing the Optimal Amount of Queue Processors*. To improve the performance, some of the following upgrades can be used:

1. Use more CPUs or CPU cores. COBOL Analyzer scales very well so the performance improvement matches the CPU cores added - verification performance is improved by 90% when CPU cores are doubled. The limit is eight physical cores that exclude hyper threading, with 16 queue processors. Each concurrent Queue Processor instance needs up to an additional 2GB of RAM. Make sure your database server can support the additional Queue Processors, see *Database Server*.
2. Use more computers as processing nodes.

Recommended Configuration (66% improved performance of verification)

Type	Requirement
Processor	3 GHz quad core CPU
Physical Memory	4 GB
Hard Disk Drive	4 GB

As these processing nodes communicate extensively with the database server, a low-latency network is required between processing node(s) and database server.

 **Note:** For best results, the computers must be on the same local network. You can use a repository server or a database server (or both) as processing nodes, provided that MS Windows is installed.

Software Configuration

Verification Information

Verification is the process of analyzing the code loaded into CA. The verification process demands a lot of CPU power. COBOL Analyzer is designed to use a single CPU core for the main application, but each Queue Processor can run on a separate CPU core. The Queue Processors can even run on multiple computers to help with the verification database loading. There are two ways of initiating the verification process. The first is the online tool (COBOL Analyzer) and the second is through the Batch Refresh Process (BRP).

Parallel Verification

By default COBOL Analyzer uses serial verification both for the online tool and for BRP. If you have a multicore CPU, it is better to use parallel verification.

To enable it in COBOL Analyzer:

1. Click **Options > Workspace Options**.
2. Click **Verification > Parallel Verification** tab.
3. Select either
 - **Run Parallel Verification in the online tool**
 - **Run Parallel Verification in BRP**
4. Adjust the **Minimum Queue Processors** to improve performance when using an optimized number of CPU cores.

 **Note:** On a quad core CPU you get up to 4 times better performance provided that you use the optimal number of Queue Processors.

Choosing the Optimal Number of Queue Processors

The optimal number of Queue Processors is related to the number of physical CPU cores available.

If you have X physical CPU cores you should use at least X Queue Processors. Using more Queue Processors than physical CPU cores slightly increases performance but depending on your system setup it could also slow down the verification because of the large number of concurrent IO operations.

 **Note:** Micro Focus recommends using <number-of-physical-CPU-cores> multiplied by two.

Using More Computers

You can start a new Queue Processor on another computer to help the current verification.



Note: CA must be installed on the computer that launches a Queue Processor.

1. Open Micro Focus COBOL Analyzer Administration and click **Administer > Build New Connection**. This creates a local `.rwp` file to connect to the workspace that needs help during the verification and database loading.
2. Click **Administer > Launch Queue Processor**. The Launch Queue Processor window opens.
3. Specify the local `.rwp` file for the workspace and enter the number of Queue Processors that you want to start.

Installing and Uninstalling COBOL Analyzer

Before running an installation program described in this section, make sure you have administrative permissions for the machine on which you are performing the installation. If you do not have administrative permissions, the installation program will not let you continue.



Note: You can run the Windows Installer (.msi) installation programs "silently." That is particularly useful when you are installing clients on a network. Check with support services for the appropriate sequence of commands.

Installing CA on the Server or Client

The CA Server hosts CA workspace files and related support files. CA Clients host the link files used to connect to workspaces on the server. Follow the instructions in this section to install CA on the client or server. The Micro Focus License Manager is packaged with the installation.



Note: Having the CA server and the database on separate machines could improve performance. The installation program is the same for the CA client and CA server.

1. Double-click `COBOLAnalyzer.exe`. Note that there might be a version number in the name of the .exe file.
2. Change the installation directory if not installing to the default location.
3. Select which optional installs you want to include:
 - Microsoft SQL Server - Express Edition
 - Web Client
4. Read the End User License Agreement and check **I agree to the End User License Agreement**.
5. Click **Install**.

Uninstalling COBOL Analyzer

Follow the instructions below to uninstall an COBOL Analyzer product. Make sure you close any open CA programs before running the uninstall program.

1. Click **Start > Control Panel > Programs > Programs and Features > Uninstall a program**
2. In the **Uninstall or change a program** window, right-click the product you want to uninstall, then click **Uninstall**. You are prompted to confirm that you want to uninstall the product. Click **Uninstall**.

Post-Installation Administrative Tasks

Before you can work in COBOL Analyzer, you must complete the basic administrative tasks described in this section. You are prompted to perform the first of these tasks, configuring the CA, when you complete the installation.

Configuring COBOL Analyzer

Use the Configuration Manager in the COBOL Analyzer Administration tool to configure CA options and displays for the programming languages, dialects, character sets, and products in use at your site.

If you configure your CA for COBOL, for example, you will see only the CA options and displays appropriate for COBOL modernization. You need to configure your CA for PL/I as well, you can come back to the Configuration Manager later and select PL/I in addition to COBOL.



Note: The COBOL Analyzer Administration tool will prompt to be run with elevated privileges. This is required because some features of the tool require write access to the Program Files directory.

1. Open the Configuration Manager window.

- If you are installing CA, the Configuration Manager window opens after you finish the installation.
- If you have previously installed CA and want to reconfigure it, choose **Start > Programs > Micro Focus > Administration**. The COBOL Analyzer Administration window opens. In the **Administer** menu, choose **Configure Micro Focus**. The Configuration Manager window opens.



Note: If CA is open, you are prompted to exit. Click **OK**, then close CA.

2. Select each programming language, dialect, and character set in use at your site. Select each CA product you want to use at your site. The core Application Analyzer product is always selected. Select **Additional Tools** to enable tools not used in typical CA configurations. When you are satisfied with your choices, click **OK**.



Note: If you modify your CA configuration, make sure you upgrade workspaces created under the previous configuration.



Note: The COBOL Analyzer Administration tool will prompt to be run with elevated privileges. This is required because some features of the tool require write access to the Program Files directory.

Licensing

Although COBOL Analyzer and Business Rule Manager) are both installed by the COBOL Analyzer installer, each product is licensed separately. Follow the instructions in the topics listed below to manage your licenses.

Upgrading Customers

A customer upgrading from Modernization Workbench version 3.1 or later may use the existing license key to enable COBOL Analyzer for the same number of users.

Concurrent Use

You can license COBOL Analyzer and Business Rule Manager for concurrent use. In this mode, one license key for the purchased number of end users will be registered to a license server and each user instance will contact it for authorization.

COBOL Analyzer Licensing

A Sentinel RMS license server is installed with COBOL Analyzer.

Depending on the licensing model in use at your site, you can manage your license:

- Locally, using the installed Sentinel RMS license server.
- Remotely, using a Sentinel RMS license server that has been configured to manage licenses centrally.



Note: The remote license server uses the same software as the local license server that is installed with COBOL Analyzer.

You will need to apply a license in the Micro Focus License Administration to use COBOL Analyzer. To start the Micro Focus License Administration, choose **Start > All Programs > Micro Focus License Manager > License Administration**.

- If you use a local license server, you can apply a license using an authorization code or a licensing file in the **Install** tab of the License Administration.
 - **Authorization code:** Enter the 16-character license authorization code for COBOL Analyzer, then click **Authorize**.
 - **Licensing file:** Enter your downloaded license file (.mflic) by browsing or dropping the file, then click **Install Licenses**.
- If you use a remote license server, click **Options > Advanced Configuration**, then click **Change** in the **License server** field. Enter the IP address or server name of the license server, then click **Save**.

Your License System Administrator can tell you which licensing model your site uses and provide you with the name of the remote license server if needed. For complete information, including how to configure a remote license server, refer to the help provided with the License Administration tool.

Business Rule Manager Licensing

Trial licenses are not provided for Business Rule Manager. Before you can work with it, you must enter the 16-character license authorization code:

- Choose **Start > Programs > Micro Focus License Manager > License Management System**. In the Licensing System Administration tool, click the **Authorize** tab, then enter the authorization code in the **Enter authorization code** field and click **Authorize**.

Micro Focus End User License Agreement

IMPORTANT: LICENSOR PROVIDES LICENSED SOFTWARE TO LICENSEE UNDER THIS END USER LICENSE AGREEMENT (THE "AGREEMENT"). THIS AGREEMENT GOVERNS LICENSEE'S INSTALLATION AND USE OF THE VERSION OF THE LICENSED SOFTWARE IDENTIFIED IN THE APPLICABLE PRODUCT ORDER, OR IF NOT ACQUIRED VIA A PRODUCT ORDER, LICENSEE'S INSTALLATION OR USE OF THE LICENSED SOFTWARE CONSTITUTES ACCEPTANCE OF THIS AGREEMENT. THE TERMS AND CONDITIONS OF THIS AGREEMENT MAY BE DIFFERENT FROM THE AGREEMENT(S) THAT ACCOMPANIED EARLIER RELEASES OF THE LICENSED SOFTWARE. PLEASE READ THIS AGREEMENT CAREFULLY BEFORE PROCEEDING, AS IT MAY CONTAIN ADDITIONAL RESTRICTIONS ON YOUR USE OF THE SOFTWARE. THIS AGREEMENT SUPERSEDES AND CONTROLS OVER ANY OTHER TERMS PROVIDED TO LICENSEE REGARDING LICENSEE'S USE OF THE LICENSED SOFTWARE, WHETHER WRITTEN OR ORAL, AS PART OF A

SIGNED AGREEMENT (INCLUDING, BUT NOT LIMITED TO, MASTER AGREEMENTS AND PORTFOLIO TERMS, UNLESS A DIFFERENT AGREEMENT IS EXPRESSLY REFERENCED IN A PRODUCT ORDER OR EXECUTED BY LICENSOR AND LICENSEE SPECIFYING THAT IT APPLIES TO THE VERSION OF THE LICENSED SOFTWARE TO WHICH THIS AGREEMENT RELATES), A CLICK-WRAP AGREEMENT PROVIDED WITH THE LICENSED SOFTWARE OR OTHERWISE (SUCH TERMS REFERRED TO AS THE "OTHER AGREEMENT"), EVEN IF SUCH OTHER AGREEMENT WAS EMBEDDED WITHIN PREVIOUSLY LICENSED SOFTWARE. LICENSOR RESERVES THE RIGHT TO UPDATE, AMEND, AND/OR MODIFY THIS AGREEMENT FROM TIME TO TIME, AND MAY INCLUDE SUCH UPDATED AGREEMENT WITH OR EMBEDDED IN FUTURE VERSIONS OF THE LICENSED SOFTWARE. PLEASE DIRECT ANY QUESTIONS TO THE MICRO FOCUS LEGAL DEPARTMENT AT LEGALDEPT@MICROFOCUS.COM.

ENTERING INTO THIS AGREEMENT DOES NOT CONSTITUTE A SALES TRANSACTION. THE SALE OF A LICENSE TO SOFTWARE PRODUCTS TAKES PLACE UNDER PRODUCT ORDERS WHICH (UNLESS OTHERWISE STATED IN THE PRODUCT ORDER) INCORPORATE THE TERMS OF THIS AGREEMENT.

Capitalized terms in this Agreement are defined as follows:

"Additional License Authorization" or **"ALA"** means the additional specific software license terms that govern the authorized use of a given software product of Licensor, including requirements for any non-production use rights described in the Non-Production Licensing Guide, and License Options available for that software product, along with additional terms or conditions applicable to a given License Option, all of which are made a part of this Agreement. The applicable Additional License Authorization for the Licensed Software is either attached hereto or can be found here: <https://software.microfocus.com/en-us/about/software-licensing> by product name and version; all references in this Agreement to "Additional License Authorization" or "ALA" shall refer to the ALA that corresponds to the version of the Licensed Software.

"Documentation" means the user documentation that Licensor makes available for the Licensed Software in electronic form or paper form.

"Licensee" means the legal entity or individual that is identified in the applicable Product Order or who has rightfully received a license to the Licensed Product.

"License Option" means the type of license available for a given software product (such as a named user license, concurrent user license or server license). In addition to the ALA, a License Option may be set forth in a Product Order or an agreement executed in writing by Licensee and Licensor.

"Licensor" means the applicable Micro Focus entity and its affiliates who own the intellectual property rights in Licensed Product.

"Licensed Product" means the Licensed Software and Documentation.

"Licensed Software" means the executable version of Licensor's software listed in the Product Order or otherwise provided to or rightfully acquired by Licensee. This Agreement shall govern the use of any update to the Licensed Software that Licensee receives pursuant to a separate support and maintenance agreement as described in Section 4 below, unless such update contains, comes with, or is otherwise specifically governed by a different end user license agreement.

"Product Order" means an agreement between Licensor and Licensee that consists of a document that has been (i) submitted by Licensee describing the License Option(s) to be purchased for the Licensed Software, and (ii) accepted by Licensor (a) in writing or (b) by delivering the Licensed Software to Licensee, whichever occurs first. A Product Order may also consist of a written quote, or other written document issued by Licensor (the "Quote"), (i) describing the License Options for the Licensed Software to be purchased, and (ii) that is accepted by Licensee before the Quote expires either by (a) returning the Quote signed by an authorized representative of Licensee, (b) issuing a purchase order that references the Quote (if the Quote expressly allows acceptance in this manner), or (c) paying Licensor the fees listed in the Quote. Unless otherwise expressly set forth in the relevant Product Order, each Product Order incorporates the terms and conditions of this Agreement, and in no event will any different or additional terms of a purchase order or similar document issued by Licensee in connection with this Agreement or a Product Order apply, and any such additional or different terms are hereby rejected by the Licensor. For purposes

of this paragraph, "Licensor" shall also include the relevant Micro Focus entity as defined above and its authorized distributors and resellers. Any conflicting or additional terms in a Product Order accepted by an authorized distributor or reseller of Licensor shall have no effect unless such terms have been agreed to by the applicable Micro Focus entity in writing.

"Third Party Component" means any run time or other elements owned or licensed to Licensor by a third party (other than open source code or elements) which may be embedded in the Licensed Software.

"Third Party Software" means additional or accompanying software owned or licensed by a third party (such as Adobe Acrobat or Microsoft Internet Explorer, but not any open source code or elements) that may be specified in the Documentation or in a file accompanying such Licensed Software.

"Warranty Period" means the ninety (90) day time frame beginning on date of delivery of the Licensed Software to Licensee (Licensed Software delivery is deemed to occur when the Licensed Software is physically delivered to Licensee EXWORKS or made available for download to Licensee).

1. GRANT OF LICENSE; LICENSE CONDITIONS.

- a.** License Grant. Subject to Licensee's compliance with the terms and conditions of this Agreement (including but not limited to payment of applicable fees), Licensor grants to Licensee a personal, non-transferable, non-sublicensable and non-exclusive license to use the Licensed Software as authorized by the License Option(s) specified in the ALA solely for Licensee's internal business operations, functions and benefit, and not for commercialization of the Licensed Software or to provide services or benefit to any affiliates or subsidiaries of Licensee or any other third party. Throughout the license term, Licensee agrees to: (i) implement internal safeguards to prevent any unauthorized copying, distribution, installation, use of, or access to, the Licensed Products and associated support and maintenance, or any other breach of this Agreement; and (ii) take all necessary steps to destroy or erase all Licensed Software codes, programs, Documentation, and other proprietary information of Licensor before disposing of any media or hardware. Licensor will provide any license key necessary for activation and use of the Licensed Software. Licensor is not liable or responsible for lost or broken license keys and is not obligated to replace license keys or issue new license keys unless (1) Licensee has purchased a support and maintenance plan for the applicable Licensed Software that specifically covers the issuance of new or replacement keys and (2) the applicable version of the Licensed Software is then generally available for distribution by Licensor. If Licensee has not paid for such a support and maintenance plan, replacement or new license keys may be available for purchase at Licensor's then-current list price for applicable new licenses.
- b.** Evaluation Licenses. With respect to any Licensed Software provided to Licensee solely for evaluation purposes (an "Evaluation License"), in the event of conflict this Section 1.b shall prevail over any other provisions set forth in this Agreement. An Evaluation License may be used for a period of no more than thirty (30) days from the date the Licensed Software is provided to Licensee ("Evaluation Term"), unless a different period is specified in writing by Licensor. An Evaluation License may be used solely for Licensee's internal evaluation and testing purposes on a single computer system and not for development, commercial, or production purposes. For Licensed Software subject to an Evaluation License, (i) Licensee may not reproduce or distribute the Licensed Products; and (ii) Licensee's results of benchmark or other performance tests run on or using the Licensed Software may not be disclosed to any third party without Licensor's prior written consent. At any time during the Evaluation Term or upon completion thereof, Licensee may, upon written notification to Licensor and payment of the applicable license fee, replace the Evaluation License with a license to use the Licensed Software that is not restricted to evaluation purposes. In the absence of such notification by Licensee, the Evaluation License shall automatically terminate at the end of the Evaluation Term, and Licensee shall return, or, if Licensor so directs, delete and destroy all such Licensed Software and provide Licensor with written confirmation of its compliance with this provision. Upon written request from Licensee, Licensor may, in its sole discretion, grant Licensee an extension in writing prior to the expiration of the Evaluation Term. Other than updates to Licensed Software provided as part of support and maintenance, Licensed Software provided by Licensor free of license fee charge shall be deemed to be provided for evaluation purposes only. Licensed Software furnished under an Evaluation License is provided without any contractual obligation of

maintenance and support by Licensor and is provided "as is" without warranties, implied or express, of any kind.

- c. Bundles/Suites. If the Licensed Software is licensed in a bundle or suite of multiple products, and the applicable Product Order specifies the License Option and license count for the bundle or suite (but not the individual product components of the bundle or suite), then each product in the bundle or suite shall share such license type and count. For example, individual products in the bundle or suite cannot be used by multiple users if only one user license is purchased (for user-based licenses) and cannot be installed on multiple devices or servers if only one device or server license is purchased (for device or server-based licenses).

2. USE RESTRICTIONS. Except as may be otherwise specifically permitted in the applicable ALA, Licensee agrees not to, directly or indirectly:

- a. Copy, distribute or use the Licensed Software, in whole or in part (such as any portion, feature, function, or user interface) without paying Licensor the applicable fees;
- b. Use the Licensed Software as a service, or for timesharing, facilities management, outsourcing, hosting, service bureau use, or for providing other application service (ASP) or data processing services to third parties or for like purposes, or permit the use of the Licensed Software by a third party or permit access by or use for the benefit of any third party without executing a separate distribution agreement for the Licensed Software and paying Licensor the applicable required additional fees;
- c. Modify or create derivative works of the Licensed Software, or decrypt, translate, disassemble, recompile, decompile or reverse engineer the Licensed Software or attempt to do so (except to the extent applicable law specifically permits such activity, in which case Licensee must provide Licensor with detailed information regarding such activities);
- d. Alter, destroy, or otherwise remove any proprietary notices or labels on or embedded within the Licensed Software;
- e. Use the Licensed Software in a manner other than as specifically permitted in this Agreement or an ALA;
- f. Assign, sell, resell, license, rent, lease, lend, sublicense, outsource or otherwise transfer the Licensed Software to any third party, without first paying Licensor the applicable required license fees and obtaining Licensor's prior written consent;
- g. Authorize, allow or appoint any third party to do any of the foregoing. For the avoidance of doubt, third parties include, without limitation, contractors and consultants (including contractors and consultants retained to provide services solely for the benefit of Licensee), outsourcers, Licensee's affiliates and subsidiaries, parent companies, customers, and the public; or
- h. Publish or disclose to third parties any evaluation or benchmarking of the Licensed Software without Licensor's prior written consent.

Notwithstanding the foregoing, Licensee may: (i) make a reasonable number of archival back-up copies of the Licensed Software and (ii) make a reasonable number of copies of the Documentation. Licensee shall reproduce all copyright and other proprietary rights notices appearing in or on the Licensed Products, including notices of all third party suppliers.

3. TERM OF LICENSE. This Agreement and the license term for the Licensed Software granted herein is perpetual, unless a subscription/term license has been purchased by Licensee (in which case the license term shall be set forth in the Product Order or ALA), and is subject to earlier termination as provided in this Section 3. If Licensee has purchased a subscription/term license, such license shall automatically terminate upon expiry of such subscription/term, unless earlier terminated under this Section 3. Licensor may terminate this Agreement, along with any or all licenses then in effect with Licensee, immediately by giving Licensee written notice of termination in the event that (i) Licensee breaches any term or condition of this Agreement and fails to remedy such breach within ten (10) days of receipt of Licensor's notice detailing such breach; (ii) Licensee becomes insolvent, has a receiver appointed, or files for or has filed against it, liquidation, bankruptcy or analogous proceedings; or (iii) Licensee infringes or misappropriates the intellectual property rights of Licensor. Termination shall be without prejudice to any other rights or remedies Licensor may have. In the event of any termination, Licensee's license(s) to install, access or use the Licensed Software will immediately terminate, and Licensee shall destroy and erase all copies of such Licensed Software in its possession or control and provide written certification to Licensor that it has complied with this provision. Early termination of this

Agreement shall not entitle Licensee to any refund or reimbursement of any previously paid fees. The rights and obligations of the parties contained in Sections 3 (Term of License), 6 (Disclaimer of Warranty), 7 (Limitation of Liability), 8 (High Risk Uses), 9 (Ownership), 10 (Third Party Software and Components), 11 (Notice to U.S. Government End Users), 12 (License Fees and Payment Terms), 13 (Audits), 15 (Privacy and Use of Licensee Information), 16 (Licensee Trademark and Feedback) and 17 (Miscellaneous) will survive the termination or expiration of this Agreement.

- 4. SUPPORT AND MAINTENANCE.** Licensee is not entitled to any updates to the Licensed Software, unless Licensee purchases maintenance and support services pursuant to Licensor's then-current applicable standard maintenance and support agreement, which can be found at <https://www.microfocus.com/support-and-services/maintenance-and-support-agreements/> or can be provided by Licensor at Licensee's request. Maintenance and support services (including, but not limited to, any new versions, bug fixes, and patches) provided by Licensor will be subject to such agreement. Where Licensee purchases maintenance and support for any Licensed Software, Licensee hereby agrees to purchase or keep current on such maintenance and support services for all of Licensee's licensed units of such Licensed Software product, regardless of License Option.
- 5. LIMITED WARRANTY.** Licensor warrants for the Warranty Period that: (i) if the Licensed Software is supplied via media, the media will be free from defects in materials or workmanship under normal use, and (ii) the copy of the Licensed Software delivered to Licensee substantially conforms in all material respects to the Documentation. Licensee's sole and exclusive remedy for any defective media supplied by Licensor shall be Licensor's repair or replacement of such defective media free of charge, provided that the defective media is returned to Licensor during the Warranty Period. During the Warranty Period, Licensee's sole and exclusive remedy for not meeting part (ii) of the above warranty shall be the repair or replacement of the Licensed Software by Licensor free of charge so that it substantially conforms to the Documentation or, if Licensor reasonably determines that such remedy is not economically or technically feasible, Licensee shall be entitled to a full refund of the license fee and any maintenance fee paid for such Licensed Software. Upon such refund, Licensee's license to use such Licensed Software will immediately terminate. The warranties set forth in this Section 5 shall not apply if the defects in the Licensed Software or media result from: (a) failure to use the Licensed Software in accordance with the Documentation, this Agreement or ALAs; (b) the malfunctioning of Licensee's equipment or network; (c) accident, neglect, or abuse; (d) service by any unauthorized person; (e) other software used by Licensee and not provided by Licensor, or for which the Licensed Software is not designed or licensed for such use; (f) Third Party Software that is not a Third Party Component; (g) any other cause occurring after initial delivery of the Licensed Software or media to Licensee, unless caused directly by Licensor. Licensor has no responsibility for any claims made outside of the Warranty Period. The foregoing warranty shall not apply to any free-of-charge Licensed Software or updates provided under support and maintenance. THE FOREGOING WARRANTIES DO NOT APPLY, AND LICENSOR DISCLAIMS ALL WARRANTIES, WITH RESPECT TO ANY THIRD PARTY SOFTWARE THAT IS NOT A THIRD PARTY COMPONENT. The warranties set forth in this Section 5 will not apply and will become null and void if Licensee materially breaches any provision of this Agreement.
- 6. DISCLAIMER OF WARRANTY.** EXCEPT FOR THE LIMITED WARRANTY SET FORTH IN SECTION 5, THE LICENSED PRODUCTS ARE PROVIDED TO LICENSEE "AS-IS" WITHOUT WARRANTY OF ANY KIND. LICENSOR DOES NOT WARRANT THAT THE FUNCTIONS CONTAINED IN THE LICENSED SOFTWARE WILL MEET LICENSEE'S REQUIREMENTS, THAT OPERATION WILL BE UNINTERRUPTED, ACHIEVE ANY INTENDED RESULT, BE COMPATIBLE, OR WORK IN COMBINATION WITH ANY OTHER SOFTWARE, APPLICATIONS, OR SYSTEMS, MEET ANY PERFORMANCE OR RELIABILITY STANDARDS, OR BE ERROR FREE, OR THAT ANY ERRORS OR DEFECTS CAN OR WILL BE CORRECTED. EXCEPT AS SET FORTH HEREIN AND TO THE EXTENT PERMITTED BY LAW, ALL OTHER WARRANTIES WITH RESPECT TO THE LICENSED PRODUCTS, WHETHER EXPRESS OR IMPLIED, STATUTORY OR OTHERWISE, INCLUDING, BUT NOT LIMITED TO, IMPLIED WARRANTIES OF MERCHANTABILITY, QUALITY, FITNESS FOR A PARTICULAR PURPOSE, TITLE, NON-INFRINGEMENT, AND WARRANTIES THAT MAY ARISE OUT OF COURSE OF DEALING, COURSE OF PERFORMANCE, USAGE, OR TRADE PRACTICE ARE EXPRESSLY DISCLAIMED BY LICENSOR AND ITS THIRD-PARTY SUPPLIERS AND AFFILIATES. LICENSEE ACKNOWLEDGES THAT LICENSEE IS RESPONSIBLE FOR THE SELECTION OF THE LICENSED SOFTWARE TO ACHIEVE LICENSEE'S INTENDED RESULTS AND FOR THE INSTALLATION AND/OR USE OF, AND RESULTS OBTAINED FROM, THE LICENSED SOFTWARE.

7. LIMITATION OF LIABILITY.

- a. Aggregate Cap. IN NO EVENT SHALL ANY LIABILITY OF LICENSOR OR ITS AFFILIATES OR ANY OF ITS OR THEIR RESPECTIVE LICENSORS OR SERVICE PROVIDERS UNDER OR IN CONNECTION WITH THIS AGREEMENT EXCEED, IN THE AGGREGATE, THE AMOUNTS PAID BY LICENSEE FOR THE LICENSED SOFTWARE AND THE INITIAL PERIOD OF MAINTENANCE AND SUPPORT GIVING RISE TO THE APPLICABLE CLAIM.
 - b. Waiver of Liability. IN NO EVENT SHALL LICENSOR OR ITS AFFILIATES OR ANY OF ITS OR THEIR RESPECTIVE LICENSORS OR SERVICE PROVIDERS BE LIABLE FOR ANY INDIRECT, SPECIAL, INCIDENTAL, CONSEQUENTIAL, PUNITIVE OR SIMILAR DAMAGES, LOSS OF PROFITS, BUSINESS, DATA, OR PROGRAMS (INCLUDING, BUT NOT LIMITED TO, THE COST OF RECOVERING OR REPLACING SUCH DATA OR PROGRAMS), LOSS, DAMAGE OR ANY COSTS DUE TO INTERRUPTION, DELAY, OR INABILITY TO USE THE LICENSED SOFTWARE, WHETHER ARISING OUT OF OR IN CONNECTION WITH THIS AGREEMENT, EVEN IF INFORMED OF THE POSSIBILITY OF SUCH DAMAGES IN ADVANCE.
 - c. Scope. THE LIMITATIONS AND EXCLUSIONS OF THIS SECTION 7 APPLY TO ALL CAUSES OF ACTION, INCLUDING, WITHOUT LIMITATION, BREACH OF CONTRACT, BREACH OF WARRANTY, NEGLIGENCE, STRICT LIABILITY, MISREPRESENTATION AND OTHER TORTS. THESE LIMITATIONS AND EXCLUSIONS APPLY COLLECTIVELY TO LICENSOR, ITS PARENTS, AFFILIATES, AND SUBSIDIARIES AND EACH OF THEIR RESPECTIVE EMPLOYEES, CONTRACTORS, AND SUPPLIERS. NOTWITHSTANDING THE FOREGOING, NOTHING IN THIS SECTION 7 EXCLUDES LIABILITY FOR WILLFUL MISCONDUCT OR FRAUDULENT MISREPRESENTATION.
 - d. Exclusive Remedy. LICENSEE'S REMEDIES IN THIS AGREEMENT ARE LICENSEE'S EXCLUSIVE REMEDIES. LICENSEE AGREES THAT, IN ENTERING INTO THIS AGREEMENT, IT DID NOT RELY ON ANY REPRESENTATIONS (WHETHER WRITTEN OR ORAL) OF ANY KIND OTHER THAN THOSE EXPRESSLY SET OUT IN THIS AGREEMENT.
 - e. Essential Purpose. LICENSEE FURTHER ACKNOWLEDGES THAT THE LIMITATIONS AND EXCLUSIONS OF LIABILITY IN THIS SECTION 7 APPLY TO THE FULLEST EXTENT PERMITTED BY LAW AND ARE AN ESSENTIAL ELEMENT OF THIS AGREEMENT AND THAT, IN THE ABSENCE OF SUCH LIMITATIONS AND EXCLUSIONS, THE PRICING AND OTHER TERMS AND CONDITIONS SET FORTH HEREIN WOULD BE SUBSTANTIALLY DIFFERENT. THE LIMITATIONS AND EXCLUSIONS SET FORTH IN THIS SECTION 7 SHALL APPLY EVEN IF THE LICENSEE'S REMEDIES UNDER THIS AGREEMENT FAIL OF THEIR ESSENTIAL PURPOSE.
 - f. Free Software. IF LICENSOR PROVIDES LICENSEE WITH ANY LICENSED SOFTWARE FREE-OF-CHARGE OR UNDER AN EVALUATION LICENSE, TO THE EXTENT PERMITTED BY LAW, LICENSOR SHALL NOT BE RESPONSIBLE FOR ANY LOSS OR DAMAGE TO LICENSEE, ITS CUSTOMERS, OR ANY THIRD PARTIES CAUSED BY THE LICENSED SOFTWARE THAT IT MAKES AVAILABLE TO LICENSEE.
- 8. HIGH RISK USES.** The Licensed Software is not fault tolerant, nor designed, manufactured, or intended for use in hazardous environments requiring fail-safe performance (including, without limitation, the operation of nuclear facilities, aircraft navigation or communication systems, air traffic control, direct life support machines, or weapons systems) in which failure of the Licensed Software could lead directly or indirectly to death, personal injury, or severe physical or environmental damage. Licensor and its suppliers shall have no liability for any use of the Licensed Software in any high-risk situations.
- 9. OWNERSHIP.** The Licensed Products are provided under license, and not sold, to Licensee. The only rights in the Licensed Products are the licenses expressly stated in this Agreement and no other rights are implied or granted by estoppel. Licensor (and its affiliates) and its and their licensors and third party suppliers retain ownership of, and reserve all rights in and to, the Licensed Products, including all copies thereof, and all intellectual property rights arising out of or relating to the Licensed Products. Licensee shall use reasonable efforts to safeguard the Licensed Products (including all copies thereof) from infringement, misappropriation, theft, misuse, or unauthorized access. Licensee shall promptly notify Licensor if it becomes aware of any infringement or misappropriation of the Licensed Products and shall fully cooperate with Licensor, at Licensor's expense, in any legal action taken by Licensor to enforce its intellectual property rights.

10. THIRD PARTY SOFTWARE AND COMPONENTS. The Licensed Software may come with or require Third Party Software that Licensee shall license directly from the third party licensor pursuant to such third party's terms and conditions and not this Agreement. Additionally, some Licensed Software may include certain Third Party Components and open source software. Such open source software and Third Party Components may also be loaded on the Licensed Software media. Third Party Components are licensed to Licensee under this Agreement; open source software is licensed pursuant to the applicable open source license. To the extent applicable, information about the open source software may be found (i) in a file accompanying the applicable Licensed Software or (ii) in the Documentation or ALA. Licensee shall not directly access any Third Party Components other than with or as part of the Licensed Software. Licensee agrees that to the extent required by a third party licensor or supplier of a Third Party Component, that third party licensor or supplier is an intended third party beneficiary of this Agreement as necessary to protect intellectual property rights in the Licensed Software and limit certain uses thereof.

11. NOTICE TO U.S. GOVERNMENT END USERS. The Licensed Products are deemed to be "Commercial Items," as defined at 48 C.F.R. §2.101, consisting of "Commercial Computer Software" and "Commercial Computer Software Documentation," as such terms are used in 48 C.F.R. §12.212 or 48 C.F.R. §227.7202, as applicable. Consistent with such sections, the Licensed Products are licensed to U.S. Government end users (i) only as Commercial Items, and (ii) with only those rights as are granted pursuant to this Agreement.

12. LICENSE FEES AND PAYMENT TERMS. Licensee agrees to pay the applicable license fees for the Licensed Products within thirty (30) days of the date of invoice or such other date as agreed in writing by the parties. Software license fees are non-refundable, except as provided in Section 5 above, and shall be paid without any deduction or tax withholding. Software License fees are exclusive of any applicable transportation charges, sales, use, value added tax, and other applicable taxes and duties, and all such amounts shall be paid or reimbursed by Licensee. Licensee shall be liable for all outstanding past due amounts, which shall accrue interest at the rate of 1.5% per month compounded or, if lower, the maximum rate allowed by applicable law, and any collection costs associated with the collection of any past due amounts.

13. AUDITS. Licensor or an Auditor (as defined below) has the right to verify Licensee's compliance with the licenses issued under Product Orders, the applicable ALAs and this Agreement (please see Micro Focus License Compliance Charter at <http://supportline.microfocus.com/licensing/licVerification.aspx>, which can also be provided by Licensor at Licensee's request). Licensee agrees to:

- a. Recordkeeping. Keep, and upon Licensor's request, provide records, sufficient to certify Licensee's compliance with this Agreement based on the applicable License Option(s) (including applicable license metric and other terms and conditions) for the Licensed Software, which may include but are not limited to, serial numbers, license keys, logs, the location, model (including quantity and type of processor) and serial number of all machines on which the Licensed Software is installed or accessed or from which the Licensed Software can be accessed, the names (including corporate entity) and number of users accessing or otherwise able to access the Licensed Software, metrics, reports, copies of the Licensed Software (by product and version), and network architecture diagrams as they may relate to Licensee's licensing and deployment of the Licensed Products and associated support and maintenance;
- b. Questionnaire. Within seven (7) days of Licensor's request, Licensee shall furnish to Licensor or its designated independent auditor ("Auditor") a completed questionnaire provided by Licensor or Auditor, accompanied with a written statement signed by a director of Licensee certifying the accuracy of the information provided; and
- c. Access. Provide representatives of Licensor or Auditor any necessary assistance and access to records and computers to allow an inspection and audit of Licensee's computers and records, during Licensee's normal business hours, for compliance with licenses, the applicable ALAs, and this Agreement, and fully cooperate with such audit.
- d. Non-Compliance. In the event that Licensee has, or at any time has had, unlicensed installation, use of, or access to the Licensed Software or has otherwise breached this Agreement or an ALA (a "Non-Compliance"), without prejudice to any other rights or remedies Licensor may have, including, without limitation, injunctive relief, Licensee shall, within thirty (30) days' notice of such Non-Compliance to Licensee, purchase sufficient licenses and/or subscriptions and associated support and maintenance to cure the Non-Compliance, by paying Licensor's current (as of the date of such

additional purchase) list license fees and 12-month support and maintenance fees to Licensor for such additional licenses, plus Licensor's current (as of the date of such additional purchase) list term license and support and maintenance fees and interest (compounded at 1.5% monthly or the maximum rate permitted by applicable law if lower) for such additional licenses for the time period from the commencement of the Non-Compliance until payment of the aforementioned fees, with interest payable even if an invoice was not issued at the time the Non-Compliance occurred. For purposes of the foregoing, "list" shall mean Licensor's full list price as set forth in Licensor's standard price list that is current as of the commencement of the audit without any volume or other discount. If Licensee's Non-Compliance results in an underpayment of license fees of 5% or greater, Licensee shall also reimburse Licensor for the reasonable cost of such audit in addition to other amounts due. In the event of a dispute related to a Non-Compliance, Licensor shall have the right to collect from Licensee its reasonable costs and attorneys' fees incurred in enforcing this Agreement.

14. RELATED SERVICES. Licensee shall be responsible for obtaining and installing all proper hardware and other third party support software (including operating systems) for the proper installation and implementation of the Licensed Software. In the event that Licensee retains Licensor to perform any services with respect to the Licensed Software (for example: installation, implementation, maintenance, consulting, or training services), Licensee and Licensor agree that such services shall be provided at Licensor's then- current standard terms, conditions, and rates for such services unless otherwise agreed in writing by Licensor.

15. PRIVACY AND USE OF LICENSEE INFORMATION.

a. Responsibility and Compliance with Laws. Licensee is solely responsible for and assumes all liability with respect to its own collection, processing, storage, and transfer of any user data, including, but not limited to, personally identifiable information and personal health and financial information (collectively, "Personal Information"). Licensee shall be solely responsible for notifying its users of proper use of such data. Each party is responsible for complying with its respective obligations under all applicable laws, regulations, and industry standards regarding data collection and data privacy applicable for the use of the Licensed Software by the relevant party.

Licensee shall not provide any Personal Information to Licensor for processing by Licensor on behalf of Licensee, unless otherwise agreed by the parties in writing in an applicable transaction document with applicable privacy terms. If the parties agree that processing Personal Information is necessary for the performance of this specific transaction, and when such Personal Information processing falls within the scope of the General Data Protection Regulation (EU) 2016/679 ("GDPR"), before any Personal Information is made available to Licensor, the parties agree that Licensee will be the data controller and Licensor will be the data processor, and when Licensor is processing Personal Information on behalf of Licensee, such processing shall be governed by terms that comply with Article 28 of the GDPR including standard contractual clauses to be included in such transaction document.

Licensor will not have access to protected health information unless the parties have an executed business associate agreement in place for this transaction. Licensee is solely responsible for assessing the Licensed Product or any related product or service for compliance with any industry requirements applicable to Licensee.

b. Consent to Use of Licensee Information. To the extent required or permitted by law, Licensee hereby expressly consents to (i) receiving information from Licensor from time to time advertising Licensor's products; (ii) the use of Licensee's name in Licensor customer lists, promotional materials, and press releases; and (iii) the collection and use of information about the computer system on which the Licensed Software is installed (e.g. product version, serial number) for internal security and licensing purposes. Further information about Licensor's processing of personally identifiable data is available at <https://www.microfocus.com/about/legal/#privacy> (click "Privacy Notice" tab) or can be provided by Licensor at Licensee's request.

c. Other Use of Licensee Information. To the extent required or permitted by law, and notwithstanding the terms in Section 15.a, Licensor may also process personally identifiable information of Licensee and Licensee's users (i) in order to comply with a legal obligation to which Licensor is subject; (ii) as is necessary for the performance of this Agreement; and (iii) where necessary for the purposes of Licensor's legitimate interests, except where such interests are overridden by the interests or

fundamental rights and freedoms of the Licensee or Licensee's users which require protection of personally identifiable information.

16. LICENSEE TRADEMARK AND FEEDBACK. Licensor may use Licensee's name and logo for business development and marketing purposes, including, but not limited to, online and printed sales and marketing materials. Any other use of Licensee's name or logo, or a description of Licensee's use of the Licensed Software, shall be subject to Licensee's prior consent. Any suggestions, ideas for modifications, enhancements, and other feedback from Licensee regarding the Licensed Software provided at any time (collectively, the "Feedback"), including (but not limited to) all intellectual property rights in and to such Feedback, shall be owned exclusively by Licensor. Licensee hereby assigns all right, title and interest in and to such Feedback and all the intellectual property rights therein to Licensor, without the necessity of any further consideration. To the extent any Feedback cannot be assigned to Licensor, Licensee hereby grants to Licensor a perpetual, irrevocable, exclusive, worldwide, royalty-free, fully paid up license, with the right to sublicense through multiple tiers to use, make, sell, distribute, execute, adapt, translate, reproduce, display, perform, modify, create derivative works of and otherwise exploit the Feedback in any manner.

17. MISCELLANEOUS.

- a. Assignment. Licensor may assign this Agreement, including any rights or obligations under the Agreement (in whole or in part) to a parent or an affiliate. Licensee may not assign or transfer this Agreement or any of its rights or duties hereunder, including (but not limited to) by merger, acquisition by any entity of all or substantially all of Licensee's stock or assets, change of control, operation of law, or otherwise, without the prior written consent of Licensor and payment by Licensee of the applicable assignment fee. Any attempted assignment not in accordance with this Section shall be null and void.
- b. Governing Law. If Licensee is located in North America, the laws of the State of California govern this Agreement and the licenses granted hereunder, and the parties hereto consent to the exclusive jurisdiction of the State and Federal courts of the State of California in any action based on this Agreement or the Licensed Software hereunder or any License Option under an ALA. Each party waives any right it may have to object to such venue, including objections based on personal jurisdiction or forum non conveniens (inconvenient forum). The parties agree that the Uniform Computer Information Transaction Act or any version thereof, adopted by any state, in any form ("UCITA"), shall not apply to this Agreement. To the extent that UCITA is applicable, the parties hereby opt out of the applicability of UCITA pursuant to the opt-out provision(s) contained therein. If Licensee is located in France, Germany or Japan, this Agreement is governed by the laws of the country in which Licensee is located. In the rest of the world the laws of England govern this Agreement. In each case, the applicable law shall apply without regard to conflict of laws provisions thereof, and without regard to the United Nations Convention on the International Sale of Goods. Other than for North American transactions, this Agreement, the licenses granted hereunder, and the parties hereto, shall be subject to the exclusive jurisdiction of the courts of the country determining the applicable law as aforesaid.
- c. Export Control. This Agreement may be subject to export control laws, regulations, and other restrictions of the United States (including, but not limited to, the U.S. Export Administration Regulations (the "EAR")), United Kingdom, or the European Union regarding export or re-export of computer software and technology. Licensee agrees to comply with all applicable export control laws, regulations, and restrictions, including the EAR, where applicable.
- d. Entire Agreement. The applicable Product Order and this Agreement including the applicable ALA, constitutes the complete and exclusive statement of agreement between the parties relating to the license for the Licensed Products and supersedes all prior proposals, communications, purchase orders, and agreements (including, without limitation, Other Agreements), without need for a mutually executed amendment to any such Other Agreement. Any conflicting terms and conditions shall be resolved according to the following order of precedence: the applicable Product Order, the applicable ALA, and then this Agreement in all other respects.
- e. Amendment. No representation, supplement, modification, or amendment of this Agreement will be binding on either party unless executed in writing by duly authorized representatives of both parties (excluding any distributor or reseller of Micro Focus) to this Agreement.
- f. Waiver. No waiver of any right under this Agreement will be effective unless in writing and signed by authorized representatives of both parties (excluding any distributor or reseller of Licensor). No

waiver of any past or present right arising from any breach or failure to perform will be deemed to be a waiver of any future right arising under this Agreement.

- g. **Severability.** If any provision in this Agreement is invalid or unenforceable, that provision will be construed, limited, modified or, if necessary, severed, to the extent necessary, to eliminate its invalidity or unenforceability, and the other provisions of this Agreement will remain unaffected.
- h. **No Reliance.** Each party acknowledges that in entering into this Agreement it has not relied on any representations, agreements, warranties or other assurances (other than those repeated in this Agreement) and waives all rights and remedies which but for this Section 17 would be available to it.

Micro Focus EULA (1 November 2019)

Additional License Authorizations for Visual COBOL & Enterprise software products

This Additional License Authorizations document ("ALA") set forth the applicable License Options and additional specific software license terms that govern the authorized use of the software products specified below, and are part of the applicable agreement (i.e., Micro Focus End User License Agreement; and/or any separate agreement that grants Licensee a license to such products (e.g., Customer Portfolio Terms or other Master Agreement); and/or Quotation) (the "Applicable Agreement"). Capitalized terms used but not defined herein shall have the meanings set forth in the Applicable Agreement.

Products and Suites covered

Products	E-LTU or E-Media available *	Non-production software class **	Term License Non-production software class (if available)
Business Rule Manager	Yes	Class 2	Class 2
COBOL Analyzer	Yes	Class 2	Class 2
COBOL Server	Yes	Class 2	Class 2
COBOL Server for Stored Procedures	Yes	Class 2	Class 2
COBOL 2010 Runtime	Yes	Class 2	Class 2
COBOL 2010 Runtime Test Server	Yes	Class 2	Class 2
Database Connectors (all variants)	Yes	Class 2	Class 2
Enterprise Analyzer (all variants)	Yes	Class 2	Class 2
Enterprise Analyzer Server (all variants)	Yes	Class 2	Class 2
Enterprise Developer (all variants)	Yes	Class 2	Class 2
Enterprise Server (all variants)	Yes	Class 2	Class 2
Enterprise Server for Stored Procedures (all variants)	Yes	Class 2	Class 2
Enterprise Test Server	Yes	Class 2	Class 2

Products	E-LTU or E-Media available *	Non-production software class **	Term License Non-production software class (if available)
Enterprise Test Server Premium	Yes	Class 2	Class 2
Enterprise View	Yes	Class 2	Class 2
Relativity Designer Suite for MF COBOL	Yes	Class 2	Class 2
Relativity for Windows Workstations for MF COBOL	Yes	Class 2	Class 2
Relativity Server for MF COBOL	Yes	Class 2	Class 2
Visual COBOL (all variants)	Yes	Class 2	Class 2

Suites	E-LTU or E-Media available *	Non-production software class **	Term License Non-production software class (if available)
Visual COBOL for Eclipse Distributed Edition	Yes	Class 2	Class 2
Visual COBOL for ISVs	Yes	Class 2	Class 2
Visual COBOL Studio Distributed Edition for ISVs	Yes	Class 2	Class 2

* Any product sold as E-LTU or E-Media shall be delivered electronically regardless of any contrary designation in a purchase order.

** Additional licenses solely for non-production use may be available as specified in the Non-Production Licensing Guide found at software.microfocus.com/legal/software-licensing depending on the non-production software class specified above. Any such non-production licenses will be subject to the Non-Production Licensing Guide and the applicable License Option terms and conditions set forth in this ALA.

Definitions

Term	Definition
Authorized User	Means a single user that has been authorized by Licensee to use the Licensed Software or any device or other software program that may access the Licensed Software, either directly or indirectly through any other software program, regardless of how such access occurs or if such individual uses any hardware or software that reduces the apparent number of users who are using the Licensed Software, such as by using a terminal service.
Batch Processing	Means the execution of one or more tasks, transactions or programs by a computer system without the continuous interaction of the end user with the Licensed Software for the entire period during which each such task, transaction or program is being executed by the system. Batch processing includes situations where a

Term	Definition
	queue of jobs is processed as resources become available and is in contrast to transaction or interactive processing.
Concurrent Users	Means individuals who, at the same point in time, have accessed or used the Licensed Software via any device or other software program, directly or indirectly, regardless of how such access occurs or whether such user uses any hardware or software that reduces the apparent number of users who are using the Licensed Software, such as by using a terminal service.
Container	Means an isolated user-space instance created using operating-system-level virtualization, also known as containerization. A program running inside a Container whether standalone or using an orchestration technology, can only see the resources and devices assigned to the Container. Examples of such container technologies include Docker and podman and examples of orchestrators include Kubernetes and Open Shift.
Core	Means a physical (not virtual) subunit within a CPU on a single chip that handles the main computational activities of a computer. A CPU may have one or more Cores and therefore be a "Multicore CPU" if it has more than one Core.
CPU or Central Processing Unit	Means a data processing unit, normally identified with a single microchip mounted on a single circuit board and can comprise several Cores.
E-LTU <i>and</i> E-Media	Means products which are electronically delivered only, and as such any reference to FOB Destination or delivery methods that are stated on your purchase order other than electronic shall be null and void with respect to these E-LTU or E-Media products.
Hard Partitioning	Means using hard physical partitioning to physically segment a single larger server or machine into separate and distinct smaller systems where each separate system acts as a physically independent, self-contained server or machine with its own CPUs, operating system, separate boot area, memory, input/output subsystem and network resources (each known as a "Hard Partition"). Examples of Hard Partitioning methods include: Dynamic System Domains (DSD) -- enabled by Dynamic Reconfiguration (DR), Solaris Zones (also known as Solaris Containers, capped Zones/Containers only), IBM LPAR (adds DLPAR with AIX 5.2), IBM Micro-Partitions (capped partitions only), vPar, nPar, Integrity Virtual Machine (capped partitions only), Secure Resource Partitions (capped partitions only), and Fujitsu's PPAR. All approved hard partitioning technologies must have a capped or a maximum number of Cores/processors for the given partition.

Term	Definition
Named User	Means a single user that has been authorized by Licensee to use the Licensed Software.
Platform	Means a hardware chipset (e.g., PA-RISC, Itanium, x86, or SPARC) and operating system (e.g., Windows, Linux, Solaris, AIX, or HP-UX) combination. Each unique Linux distribution is considered a different operating system from other Linux distributions and a different Platform even with the same hardware chipset.
Soft Partitioning	Means using an operating system resource manager to segment and limit the number of Cores, CPUs, or other processing devices utilized by the Licensed Software by creating areas where processor resources are allocated and limited within the same operating system (each such area known as a "Soft Partition"). Examples of such Soft Partitioning include: Solaris 9 Resource Containers, AIX Workload Manager, HP Process Resource Manager, Affinity Management, Oracle VM, and VMware.
Virtual Machine	Means a software implementation that can run its own operating system and execute programs like a physical machine where the software running inside the virtual machine is limited to the resources and abstractions provided by the virtual machine.

License Options

The following License Options are the types of licenses available for a given software product as further specified in this ALA. The applicable License Option for a license shall be as set forth in the Applicable Agreement or Product Order. Those products with only one License Option available shall be governed by such License Option whether or not stated in the Applicable Agreement or Product Order unless otherwise agreed in writing between Licensee and Licensor.

Named User License

Licensed Software provided under this License Option gives Licensee the right to install the Licensed Software on a single physical or Virtual Machine or server, or one or more Containers on such single physical or Virtual Machine or server, for use solely by the number of Named Users expressly authorized by Licensor in the Product Order for such license for whom Licensee has paid the applicable license fee. Each such Named User has the right to unlimited access to the Licensed Software on such single machine or server. A Named User License is required for each Named User that uses an installation of the Licensed Software. For example, if Named User A and Named User B both use the same two separate installations of the Licensed Software, a total of four Named User Licenses would be required for such use. Licensor reserves the right at any time to require Licensee to provide a list of the Named Users. Licensee may change a Named User provided that the change is made either (i) permanently, or (ii) temporarily to accommodate the use of the Licensed Software by a temporary worker while the Named User is absent, but in each case no more than once every 30 days. Licensee may not use the Licensed Software for user acceptance testing, system/load testing, production or deployment. For purposes of this ALA, a Named User License is considered to be a Development License.

Concurrent User License

Licensed Software provided under this License Option gives Licensee the right to install the Licensed Software on multiple physical or Virtual Machine host machines or servers, or one or more Containers on such physical or Virtual Machine host machines or servers, for use solely by the maximum number of Concurrent Users expressly authorized by Licensor in the Product Order for such license for whom Licensee has paid the applicable license fee. Licensee may not use the Licensed Software for user

acceptance testing, system/load testing, production or deployment. For purposes of this ALA, a Concurrent User License is considered to be a Development License.

User License (Authorized Users)

Licensed Software provided under this License Option gives Licensee the right to install the Licensed Software on an unlimited number of physical or Virtual Machine servers or Containers for use by up to the total number of Authorized Users expressly authorized by Licensor in the Product Order for such license for whom Licensee has paid the applicable license fee. The Licensed Software may not be used or accessed by (i) individuals who are not Authorized Users; or (ii) any other software or hardware device that does not require an individual to use or access it, including, without limitation, Batch Processing. Licensor reserves the right at any time to require Licensee to provide a list of the Authorized Users. Licensee may change an Authorized User provided that the change is made either (i) permanently, or (ii) temporarily to accommodate the use of the Licensed Software by a temporary worker while the Authorized User is absent, but in no event more than once every 30 days. This License Option may be further subject to the Additional License Options set forth below in this ALA. For purposes of this ALA, a User License (Authorized Users) is considered to be a Deployment License.

Server License (Concurrent Users)

Licensed Software provided under this License Option gives Licensee the right to install the Licensed Software on a single physical machine or server or Virtual Machine, or one or more Containers on such physical single machine or server or Virtual Machine, for use by the maximum number of Concurrent Users expressly authorized by Licensor in the Product Order for such license for whom Licensee has paid the applicable license fee. **The Licensed Software may not be used or accessed by any other software or hardware device that does not require an individual to use or access it including, without limitation, Batch Processing.** A Server License (Concurrent Users) cannot be split into multiple licenses of lesser quantity (e.g., a license for 10 Concurrent Users cannot be split into two licenses of five Concurrent Users each) without Licensor's prior written consent and possible provision of different license keys. This License Option may be further subject to the Additional License Options set forth below in this ALA. For purposes of this ALA, a Server License (Concurrent Users) is considered to be a Deployment License.

Server License (per core) or Server License (per IFL)

Licensed Software provided under this License Option gives Licensee the right to install the Licensed Software on a single physical machine or server ("Host Server"), or one or more Containers on the Host Server (provided such Containers are not running in a Soft Partition or Virtual Machine unless Licensee has purchased the Virtualization License Extension or otherwise been granted such rights separately from Micro Focus), and have the Licensed Software executed by up to the total number of (i) Cores in the case of a Server License (per core), or (ii) Integrated Facility for Linux processors ("IFLs") in the case of a Server License (per IFL), specified for the license in the applicable Product Order ("License Specification"). If the number of Cores is not specified for a CPU in the event a CPU is specified in the License Specification, such CPU shall be considered to be single-Core. A license covering all physical Cores or IFLs, as applicable, that are contained in and/or can be accessed by the Host Server ("Total Processors") is required with all applicable license fees paid, even if one or more of such Cores or IFLs are not accessing or running the Licensed Software for any reason, including, for example, installation of the Licensed Software in a Container that has fewer than the Total Processors allocated to it. For example, if 32 Cores are the Total Processors on the Host Server, but only 16 Cores are utilized to execute the Licensed Software, a 32-Core license is required notwithstanding the fact that 16 of the 32 Cores may not actually be accessing the Licensed Software. Each Core on a multi-core CPU requires a license covering each such Core. For example a Host Server with Total Processors consisting of a single quad-core CPU will require a 4-Core license.

Licensed Software provided under this License Option is for use by an unlimited number of Licensee's internal users, other software devices and hardware devices. **Server License (per core) and Server License (per IFL) are the only license types authorized for any Batch Processing.** Licensor reserves the right at any time to require Licensee to provide a specification of the Host Server. Licensee is required to purchase a license for the Total Processors on each Host Server that accesses or uses the Licensed Software either directly or indirectly through any other software program, regardless of how such access occurs, or if the Host Server, CPU or operator uses any hardware or software that reduces the apparent

number of Cores, IFLs, or other processing devices that are using the Licensed Software, such as by using a terminal service. This License Option may be further subject to the Additional License Options set forth below in this ALA. For purposes of this ALA, a Server License (per core) and Server License (per IFL) are considered to be Deployment Licenses.

Additional License Options

The following additional License Options may also apply to one of the License Options above if set forth in the applicable Product Order notwithstanding anything else to the contrary in this ALA:

Test License

Licensed Software provided under this License Option gives Licensee a limited license to use the Licensed Software solely for Licensee's internal testing purposes on a single computer subject to this section and the restrictions applicable to the type of license specified in the applicable Product Order (e.g., Server License (per core)) as set forth elsewhere in this ALA. In the event of a conflict, the terms and conditions in this section shall prevail. At no time may Licensee use the Licensed Software for development, commercial, or production purposes, nor may Licensee reproduce or distribute the Licensed Software or any software application programs created with it. Licensee's results of benchmark or other performance tests run on or using the Licensed Software may not be disclosed to any third party without Licensor's prior written consent.

Disaster Recovery License

Licensed Software provided under this License Option gives Licensee a limited license to use the Licensed Software solely on a Disaster Recovery System subject to this section and the restrictions applicable to the type of license specified in the applicable Product Order (e.g., Server License (per core)) as set forth elsewhere in this ALA. In the event of a conflict, the terms and conditions in this section shall prevail. A Disaster Recovery System is a single machine on which the Licensed Software is installed but is not instantiated, running, or otherwise in use except: (i) if a disaster arises and the single machine for which the Disaster Recovery System is configured to recover or replace (known as the "Primary Machine" in this clause) is unavailable, (ii) for the purposes of periodic disaster recovery testing, and/or (iii) for periodic system diagnostics or maintenance of the Disaster Recovery System itself. A Disaster Recovery License cannot be used: (a) concurrently with any other license for the Licensed Software or in any production, test, or development environments except while the Primary Machine is being recovered or replaced in a disaster recovery situation, or (b) for load-balancing, failover, testing (other than disaster recovery testing), clustering, or training purposes. Additional copies for use in production, test, and/or development environments, or for load-balancing, failover, clustering, or training purposes, must be purchased separately. The license quantity and metric of any Disaster Recovery License installed may not be less than the license quantity and metric of the standard license for the Licensed Software on the Primary Machine.

Failover License

Licensed Software provided under this License Option gives Licensee a limited license to use the Licensed Software solely on a Failover System subject to this section and the restrictions applicable to the type of license specified in the applicable Product Order (e.g., Server License (per core)) as set forth elsewhere in this ALA. A Failover System is a single machine on which the Licensed Software is installed and running, but only used to prepare for the recovery or replacement of the single machine for which the Failover System is configured to recover or replace (known as the "Primary Machine" in this clause), up to and including real-time data backups, mirroring, or any other activity to allow a synchronized switch-over from the Primary Machine. Licensee may not use the Failover License for any other purpose such as production, testing (other than failover testing), development, or training except during a disaster where the Primary Machine is unavailable. Licensee may not use the Licensed Software for load-balancing or clustering; a separate license for each of those use cases is required to be purchased by Licensee. The license quantity and metric of any Failover License installed may not be less than the license quantity and metric of the standard license for the Licensed Software on the Primary Machine.

Batch License

Where any Licensed Software is designated as a Batch License or "Batch-Only" in the applicable Product Order using such description or similar terminology, such Licensed Software may only be used to perform

batch processing on a single computer subject to the restrictions applicable to the type of license specified in the applicable Product Order (e.g., Server License (per core)) as set forth elsewhere in this ALA. In the event of a conflict, the terms and conditions in this section shall prevail.

Virtualization License Extension

For a license for which a Virtualization License Extension has been purchased, the restrictions applicable to the type of license specified in the applicable Product Order (e.g., Server License (per core)) as set forth elsewhere in this ALA for such license shall apply subject to the terms in this clause. For as long as such license is current on support and maintenance with Licensor, such license can be installed, used, or accessed on, in, or from a Virtual Machine. Such license may not be installed or used in a public cloud service. With respect to licenses based on processing devices such as Cores, the Licensed Software may be installed and used on any number of instances provided that the collective amount of licensed processing devices accessible by those instances does not exceed the applicable license quantity. For example, for Core-based licenses, the license can be used on any number of instances provided that the collective amount of Cores or vCPUs accessible by those instances does not exceed the applicable license quantity. An instance may be within a single Virtual Machine or Container that is not necessarily tied to just one physical machine. Licensee may make one (1) failover or disaster recovery copy of the Virtual Machine or Container in which the Licensed Software is installed and instantiate such Virtual Machine or Container in the event and for as long as the primary installation is unavailable.

Third Party Usage License Extension

For a license for which a Third Party Usage License Extension has been purchased, such license can be used by third party contractors of Licensee, notwithstanding any restriction to the contrary in the Applicable Agreement, provided that (1) each such third party is under a written obligation of confidentiality and restrictions of use which provide for protections and limitations of use of the license no less restrictive than the Applicable Agreement, (2) the license will only be used on behalf of Licensee, (3) such use is subject to the terms and conditions of the Applicable Agreement, and (4) Licensee remains liable for any breach by any such third party of the terms of the Applicable Agreement.

Off Continent License Extension

For a license for which an Off Continent License Extension has been purchased, such license can be used worldwide, except where prohibited by applicable law, notwithstanding any restriction to the contrary in the Applicable Agreement.

Software Specific Terms

Business Rule Manager

The following License Options apply: Named User License, Concurrent User License.

COBOL Server, COBOL 2010 Runtime

The following License Options apply: User License (Authorized Users), Server License (Concurrent Users), Server License (per core), Server License (per IFL).

With any valid and properly granted license to this Licensed Software, Licensee may reproduce and distribute internally, in whole or in part, subject to the applicable License Option as set forth in this ALA and the applicable Product Order, any software application program created by Licensee using Visual COBOL (if separately licensed to Licensee by Licensor) ("Licensee Application Software"). In such event Licensee shall (a) include Licensor's copyright notice for the Licensed Software on any product label and as a part of any sign-on message for such Licensee Application Software product; and (b) indemnify, hold harmless and defend Licensor and its third-party suppliers from and against any claims or lawsuits, including attorneys' fees, legal fees and court costs that arise out of, or result from, the use or distribution of such Licensee Application Software.

Licensee can only reproduce and distribute Licensee Application Software to third parties after entering into a separate distribution agreement with Licensor. Usage and distribution of the Licensee Application Software arises both by the explicit distribution of any Licensee Application Software and by the implicit distribution and usage of any of the Licensee Application Software's functionality when linked into another software application program. Access and/or use of data, results and/or output obtained and/or generated,

either directly or indirectly, and in any format whatsoever, through the use of any Licensed Software (such as when a user accesses an application that calls or uses output from another application running the Licensed Software, whether or not on the same machine or server) are deemed to be access and/or use of such Licensed Software. Licensor offers specific production licensing options for distribution to third parties which vary depending upon the license fees paid by Licensee and Licensee should contact its Licensor sales representative for more details.

COBOL Server for Stored Procedures

The following License Options apply: Server License (per core), Server License (per IFL).

The terms applicable to COBOL Server above apply to COBOL Server for Stored Procedures, except that COBOL Server for Stored Procedures may only be used to enable deployment of COBOL stored procedures on a single database server per license.

Database Connectors (all variants)

The following License Options apply: Server License (Concurrent Users), Server License (per core).

Enterprise Analyzer (all variants), Enterprise Analyzer Server (all variants), COBOL Analyzer, Business Rule Manager, Enterprise View

The following License Options apply: Named User License, Concurrent User License, Server License (Enterprise View only).

Named User Licenses for this Licensed Software may be installed on multiple machines for use solely by the licensed Named Users. In the event the applicable Product Order specifies an amount of lines of code for a license, then the application portfolio size (aggregate number of lines of code in all repositories created) for such license is limited to the maximum lines of code (LOC) set forth for such license in the applicable Product Order. LOC includes all lines of code from all programs (including each version of the same program), all Java files, and all job control and database definition files in the repository. Copybook and other included code is counted separately for each program in which it appears. Each Server License of Enterprise View may only be installed on one server and may only access one repository at a time.

With respect to Enterprise Analyzer, the Licensed Software may require certain third party database software beyond the limited database software that may be included with such Licensed Software, and in such event Licensee must separately purchase or otherwise obtain such database software from the applicable third party.

Enterprise Developer (all variants)

The following License Options apply: Named User License, Concurrent User License.

Licensee shall not use the Licensed Software, nor reproduce or distribute any files supplied as part of the Licensed Software, in order to create a compiler, interpreter, runtime support product or any other product that is generally competitive with or a substitute for the Licensed Software or any other Licensor product.

This Licensed Software may include or generate limited licenses for Enterprise Server or other application deployment product. If such licenses are included or generated, these limited licenses are provided solely for use by the licensed user(s) of the Licensed Software in order to unit test an application developed with the Licensed Software on the same machine or server used to develop the application and may not be used for system testing, production or deployment. Any use of this limited license outside of the development and unit testing of such applications is not permitted.

Enterprise Developer for Stored Procedure Debug. This Licensed Software may only be used to debug stored procedures on a single database server per license.

Enterprise Developer Connect. Licensee may install certain Enterprise Developer components and models in another Eclipse or IBM Developer for z environment in accordance with the applicable Documentation solely for use with a valid license for Enterprise Developer Connect.

Enterprise Developer Models. This Licensed Software may only be used with a valid license for Enterprise Developer and shall be governed by the same terms and conditions as such license. No support or maintenance is provided or available for this Licensed Software.

Enterprise Server (all variants)

The following License Options apply: User License (Authorized Users), Server License (Concurrent Users), Server License (per core), Server License (per IFL).

With any valid and properly granted license to this Licensed Software, Licensee may reproduce and distribute internally, in whole or in part, subject to the applicable License Option as set forth in this ALA and the applicable Product Order, any software application program created by Licensee using Micro Focus Enterprise Developer (if separately licensed to Licensee by Licensor) ("Licensee Application Software"). In such event Licensee shall (a) include Licensor's copyright notice for the Licensed Software on any product label and as a part of any sign-on message for such Licensee Application Software product; and (b) indemnify, hold harmless and defend Licensor and its third-party suppliers from and against any claims or lawsuits, including attorneys' fees, legal fees and court costs that arise out of, or result from, the use or distribution of such Licensee Application Software.

Licensee can only reproduce and distribute Licensee Application Software to third parties after entering into a separate distribution agreement with Licensor. Usage and distribution of the Licensee Application Software arises both by the explicit distribution of any Licensee Application Software and by the implicit distribution and usage of any of the Licensee Application Software's functionality when linked into another software application program. Access and/or use of data, results and/or output obtained and/or generated, either directly or indirectly, and in any format whatsoever, through the use of any Licensed Software (such as when a user accesses an application that calls or uses output from another application running the Licensed Software, whether or not on the same machine or server) are deemed to be access and/or use of such Licensed Software. Licensor offers specific production licensing options for distribution to third parties which vary depending upon the license fees paid by Licensee and Licensee should contact its Licensor sales representative for more details.

Enterprise Server for Stored Procedures

The following License Options apply: Server License (per core), Server License (per IFL).

The terms applicable to Enterprise Server above apply to Enterprise Server for Stored Procedures, except that Enterprise Server for Stored Procedures may only be used to enable deployment of stored procedures (either COBOL, PL/I, or both depending on what is specified for such license in the applicable Product Order) on a single database server per license.

Enterprise Test Server, Enterprise Test Server Premium, COBOL 2010 Runtime Test Server

The following License Option applies: Server License (per core).

This Licensed Software may be used only for Licensee's internal testing purposes. At no time may Licensee use the Licensed Software for any other purpose including production.

Relativity Designer Suite for MF COBOL

The following License Options apply: User License (Authorized Users).

Relativity for Windows Workstations for MF COBOL

The following License Options apply: User License (Authorized Users), Server License (Concurrent Users).

Relativity Server for MF COBOL

The following License Options apply: Server License (per core), Server License (Concurrent Users).

Visual COBOL (all variants)

The following License Option applies: Named User License.

Licensee shall not use the Licensed Software, nor reproduce or distribute any files supplied as part of the Licensed Software, in order to create a compiler, interpreter, runtime support product or any other product that is generally competitive with or a substitute for the Licensed Software or any other Licensor product.

This Licensed Software may include or generate limited licenses for COBOL Server or other application deployment product. If such licenses are included or generated, these limited licenses are provided solely for use by the licensed user(s) of the Licensed Software in order to unit test an application developed with

the Licensed Software on the same machine or server used to develop the application and may not be used for system testing, production or deployment, and may only be used if the Licensed Software is current on support and maintenance. Any use of this limited license outside of the development and unit testing of such applications is not permitted.

SUITES

Suite	Offering includes
Visual COBOL for Eclipse Distributed Edition	<ul style="list-style-type: none"> • Visual COBOL Development Hub • Visual COBOL for Eclipse
Visual COBOL for ISVs	<ul style="list-style-type: none"> • Visual COBOL Development Hub • Visual COBOL for Eclipse • Visual COBOL for Visual Studio
Visual COBOL Studio Distributed Edition for ISVs	<ul style="list-style-type: none"> • Visual COBOL Development Hub • Visual COBOL for Eclipse • Visual COBOL for Visual Studio

Additional License Terms

The following additional license terms shall apply to any software governed by this ALA:

Additional License Restrictions

Licensee shall not:

1. Permit use or access by any third party to any output directly or indirectly created by the Licensed Software without first paying Licensor any applicable additional fees required by Licensor and entering into a separate distribution license agreement with Licensor. For the avoidance of doubt, third party(ies) include without limitation contractors, outsourcers, Licensee's customers and the public.
2. Transfer, ship or use the Licensed Software outside the continent in which it was originally licensed to Licensee without first purchasing an Off-Continent License Extension or otherwise paying Licensor any applicable additional fees required by Licensor. For purposes of the foregoing, "continent" shall mean North America, South America, Europe, Africa, Asia, Australia, or Antarctica.
3. Install, use, or access the Licensed Software on, in, or from a Hard Partition, Soft Partition, or Virtual Machine, except where Licensee is otherwise expressly authorized in each instance by Licensor in the applicable Product Order or otherwise in writing separate from this ALA (the "Authorization") which in each event will be subject to Licensee's payment to Licensor of additional applicable fees required by Licensor and, if requested by Licensor, Licensee's written confirmation to Licensor of Licensee's planned installation environment signed by a director or officer of Licensee (accompanied by all information as Licensor reasonably requires to verify). Except as otherwise specified in the Authorization, where authorized in accordance with the foregoing and to the extent applicable to the subject license: (i) such Hard Partition, Soft Partition, or Virtual Machine, may only be tied to one physical machine and shall be considered the entire machine for licensing purposes; and (ii) Licensee shall provide to Licensor, at such times as Licensor may reasonably request, confirmation that Licensee's computer systems comply with the applicable Authorization and the requirements of this ALA. Such confirmation shall be signed by a director or officer of Licensee and shall be accompanied by all information as Licensor reasonably requires to verify that Licensee is utilizing the Licensed Software in compliance with the terms and conditions of this ALA and the Applicable Agreement, including without limitation any relevant hypervisor logs. The foregoing is in addition to Licensor's audit rights under the Applicable Agreement.
4. Utilize any software application and/or program created, in whole or in part, with any Development License without first purchasing a valid and properly granted Deployment License.
5. Install, access or use the Licensed Software on a Platform other than the Platform for which the Licensed Software was originally licensed to Licensee. Additional licenses for use of the Licensed

Software on a Platform other than the one set forth in the applicable Product Order may be available upon payment of an additional license fee.

All-or-None Support and Maintenance

Where Licensee purchases support and/or maintenance for the Licensed Software, Licensee hereby agrees that it shall purchase such support and/or maintenance services for all of Licensee's licensed units of such Licensed Software including all related Development Licenses and Deployment Licenses.

Academic Editions/Users

Where Licensed Software is licensed under the Micro Focus COBOL Academic Program:

- (i) Licensee shall not use the Licensed Software for any purpose other than for non-commercial education or academic research activities;
- (ii) Licensee shall not copy the Licensed Software, nor shall Licensee distribute, transfer or assign the Licensed Software without specific permission from Licensor; and
- (iii) If Licensee is the academic institution using the Licensed Software for teaching purposes, Licensee will manage all student licenses through a license server provided by Licensor in accordance with guidelines provided by Licensor. Licensee agrees to provide reports describing the number of licenses Licensee has issued in each period upon Licensor's request.

Personal Editions

With respect to any Personal Edition versions of the Licensed Software:

- (i) Licensee shall not use the Licensed Software for any purpose other than for personal educational and non-commercial activities. The Licensed Software may not be used for training or teaching purposes.
- (ii) Licensee shall not: (a) use the Licensed Software to compile source code for applications of more than two thousand, two hundred (2200) lines of procedural code (exclusive of lines containing comments and/or blanks) in any one (1) application or deploy or transfer such application on or to any other machine or third party; or (b) with respect to Enterprise Developer, use the Licensed Software for any purpose other than to input, edit and syntax check code for personal educational use.
- (iii) Licensee shall not copy the Licensed Software, nor shall Licensee distribute, transfer or assign the Licensed Software without specific permission from Licensor.

Enterprise Subscription Pay As You Go (Upfront Sub and No Upfront Sub) Licenses

Where any Licensed Software is designated as an Upfront Sub or No Upfront Sub license, then the following additional terms apply:

1. **Term.** Each license shall automatically terminate at the end of term for such license as stated in the applicable Product Order. The license must be de-installed upon termination unless Licensee purchases an additional subscription term for such license from Licensor.
2. **Payment.**
 - a. **Upfront Sub.** Fees for Upfront Sub licenses will be billed one-time in advance.
 - b. **No Upfront Sub.** Fees for No Upfront Sub licenses will be billed monthly in advance or per the frequency noted in the applicable Product Order if different. Licensee irrevocably commits to pay such fees to Licensor for the entirety of the subscription term purchased.
3. **Applicable License Extensions.** The Virtualization License Extension, Off Continent License Extension, and Third Party Usage License Extension are automatically included. Notwithstanding the terms of the Virtualization License Extension to the contrary, the Licensed Software may be installed or used in a public cloud service. If Licensee has an Applicable Agreement that permits use of the Licensed Software to provide services to end user customers, Licensee may only use a license for the Licensed Software subject to this ALA to provide services to one end user customer.
4. **Support and Maintenance.** Standard support and maintenance is included during the term of the license.

5. Platform Transfer. Licensee may freely transfer a license during the term of such license from one platform to another (excluding IFL) for which a version of the Licensed Software is generally available as of the commencement of such license.
6. Reporting and True-Up. Licensee shall provide to Licensor on a quarterly basis, or at such other times as Licensor may reasonably request, with a written report detailing the amount of usage of the Licensed Software in a format agreed in advance by the parties. At a minimum this report shall include, as applicable, the number of (i) instances of the Licensed Software, (ii) users of products licensed by named user, (iii) cores or other processing devices accessed by instances of products licensed by server or processing device, and (iv) hours of usage supported by hardware/infrastructure consumption reporting. Such report shall be signed by a director or officer of Licensee and shall be accompanied by all information as Licensor reasonably requires to verify that Licensee is utilizing the Licensed Software in compliance with the terms and conditions of the Applicable Agreement, including without limitation any relevant hypervisor logs. The foregoing is in addition to Micro Focus' audit rights under the Applicable Agreement. If the above report indicates that Licensee has exceeded the amount of instances, users, cores, or IFLs, then Licensee agrees to immediately pay Licensor for such additional usage at Licensor's Pay As You Go per-diem price specified in the applicable Product Order, or if no such pricing is specified, then Licensor's then-current Pay As You Go per-diem list pricing.

Java

The Licensed Software may require Licensee to separately obtain the Java™ Platform, Standard Edition Runtime Environment (JRE), and in such event any use of the JRE shall be governed by the license agreement accessible at <http://www.oracle.com/technetwork/java/javase/terms/license/index.html>. Use of the Commercial Features for any commercial or production purpose requires a separate license from Oracle. "Commercial Features" means those features identified Table 1-1 (Commercial Features In Java SE Product Editions) of the Java SE documentation accessible at <http://www.oracle.com/technetwork/java/javase/documentation/index.html>.

Host Connectivity Products

The Licensed Software may come with one or more software products from Licensor's Host Connectivity portfolio, and in such event, Licensee may only use such Host Connectivity software with the Licensed Software on the same machine as the Licensed Software subject to the terms and conditions applicable to the Licensed Software.

software.microfocus.com/legal/software-licensing - Latest version of software licensing documents

© Copyright 2021 Micro Focus.

April 1, 2021

Creating a Shared Folder for Workspaces

The folder in which you plan to create workspaces must be shared with team members. It is typically more convenient to share the folder before you create workspaces, but you can do it afterward if necessary, then refresh the workspace path as described in *Getting Started* in the CA documentation set.

Follow the instructions below to create a shared folder for workspaces. You must be an administrator to create a shared folder.

1. On the CA server, create a folder for CA workspaces.
2. Select the folder and choose **Sharing and Security** from the right-click menu. The Properties dialog for the folder opens. In the Sharing tab for the Properties dialog, select **Share this folder on the network** (or, on a machine in a Windows domain, **Share this folder**). Enter the share name in the **Share name** field and click **Apply**.



Note: Do not embed spaces in the share name. Doing so may cause other users to be unable to access the folder.

3. Click **Permissions**. The Permissions for Folder dialog opens. Specify the appropriate permissions for users sharing the folder and click **OK**.

Upgrading Workspaces

When you modify your CA configuration, you must upgrade every workspace created with the previous configuration. Only the master user can upgrade a workspace.

1. Choose **Start > All Programs > Micro Focus > COBOL Analyzer > COBOL Analyzer Administration**. The CA Administration window opens.
2. In the Administration window, choose **Administer > Upgrade Workspace**. The Upgrade workspace dialog opens.
3. Choose the workspace you want to upgrade, then click **Open**. A Workspace Upgrade window opens.
4. Click **Start** to begin the upgrade. In the Workspace Upgrade window you see the upgrade process (The parts that are being upgraded are highlighted and the checkbox next to each upgraded part is checked when the upgrade is complete.) You can Pause the upgrade and Resume it later.



Note: Upgrades that have stopped due to an error can be reset from the **File** menu.

5. (optional) Click **Workspace Upgrade > File > Export DDL Script** to export the DDL script to perform the upgrade and give it to a DBA.

Troubleshooting the Installation

Follow the instructions in this section to troubleshoot an CA installation.

Troubleshooting Workspace Access

The folder in which you plan to create workspaces must be shared with team members. If users are unable to access workspaces, it may be because:

- You have not shared the folder for workspaces. Share the folder, then refresh the workspace path as described in *Getting Started* in the CA documentation set.
- You shared the folder for workspaces after creating a workspace. Refresh the workspace path as described in *Getting Started* in the CA documentation set.
- You embedded spaces in the value of the **Share name** field for the folder. Remove the spaces, then refresh the workspace path as described in *Getting Started* in the CA documentation set.