

IDOL KeyView

Software Version 12.9

HTML Export SDK C and COM Programming Guide



Document Release Date: June 2021
Software Release Date: June 2021

Legal notices

Copyright notice

© Copyright 1997-2021 Micro Focus or one of its affiliates.

The only warranties for products and services of Micro Focus and its affiliates and licensors (“Micro Focus”) are as may be set forth in the express warranty statements accompanying such products and services. Nothing herein should be construed as constituting an additional warranty. Micro Focus shall not be liable for technical or editorial errors or omissions contained herein. The information contained herein is subject to change without notice.

Documentation updates

The title page of this document contains the following identifying information:

- Software Version number, which indicates the software version.
- Document Release Date, which changes each time the document is updated.
- Software Release Date, which indicates the release date of this version of the software.

To check for updated documentation, visit <https://www.microfocus.com/support-and-services/documentation/>.

Support

Visit the [MySupport portal](#) to access contact information and details about the products, services, and support that Micro Focus offers.

This portal also provides customer self-solve capabilities. It gives you a fast and efficient way to access interactive technical support tools needed to manage your business. As a valued support customer, you can benefit by using the MySupport portal to:

- Search for knowledge documents of interest
- Access product documentation
- View software vulnerability alerts
- Enter into discussions with other software customers
- Download software patches
- Manage software licenses, downloads, and support contracts
- Submit and track service requests
- Contact customer support
- View information about all services that Support offers

Many areas of the portal require you to sign in. If you need an account, you can create one when prompted to sign in. To learn about the different access levels the portal uses, see the [Access Levels descriptions](#).

Contents

Part 1: Overview of HTML Export	14
Chapter 1: Introducing HTML Export	15
Overview	15
Features	15
Platforms, Compilers, and Dependencies	16
Supported Platforms	16
Supported Compilers	17
Software Dependencies	18
Windows Installation	18
UNIX Installation	19
Package Contents	20
License Information	20
Enable Advanced Document Readers	20
Pass License Information to KeyView	21
Directory Structure	22
Definition of Terms	24
Chapter 2: Getting Started	26
HTML Export Reference Implementation	26
Architectural Overview	28
Memory Abstraction	29
Enhance Performance	30
File Caching	30
Convert Files	30
Convert Files Out of Process	31
Configure Out-of-Process Conversions	32
Run Export Out of Process—Overview	34
Recommendations	35
Run Export Out of Process	35
Example—KVHTMLStartOOPSession	36
Example—KVHTMLEndOOPSession	37
Subfile Extraction	38
Convert Outlook Email without Using the Extraction API	38
Set Conversion Options	39
Set Conversion Options by Using the API	39
Explore Conversion Options with the Sample Programs	39
Templates	40
Use the Export Demo Program	42
Change Input/Output Directories	43
Set Configuration Options	44
Convert PDF Files	44
Convert Rotated Text	45

Convert Files	45
Use the C-Language Implementation of the API	46
Input/Output Operations	47
Convert Files	47
Multithreaded Conversions	49
Use the COM Implementation of the API	49
Sample Implementation	50
Define the htmserv Object	50
Sample Code	51
Part 2: Use the Export API	53
Chapter 3: Use the File Extraction API	55
Introduction	55
Extract Subfiles	56
Sanitize Absolute Paths	57
Extract Images	58
Recreate a File's Hierarchy	58
Create a Root Node	59
Recreate a File's Hierarchy—Example	59
Extract Mail Metadata	60
Default Metadata Set	60
Extract the Default Metadata Set	61
Extract All Metadata	61
Microsoft Outlook (MSG) Metadata	61
Extract MSG-Specific Metadata	63
Microsoft Outlook Express (EML) and Mailbox (MBX) Metadata	63
Extract EML- or MBX-Specific Metadata	63
Lotus Notes Database (NSF) Metadata	64
Extract NSF-Specific Metadata	64
Microsoft Personal Folders File (PST) Metadata	65
MAPI Properties	65
Extract PST-Specific Metadata	66
Exclude Metadata from the Extracted Text File	67
Extract Subfiles from Outlook Files	67
Extract Subfiles from Outlook Express Files	67
Extract Subfiles from Mailbox Files	67
Extract Subfiles from Outlook Personal Folders Files	68
Choose the Reader to use for PST Files	68
MAPI Attachment Methods	70
Open Secured PST Files	70
Detect PST Files While the Outlook Client is Running	71
Extract Subfiles from Lotus Domino XML Language Files	71
Extract .DXL Files to HTML	72
Extract Subfiles from Lotus Notes Database Files	72
System Requirements	72
Installation and Configuration	73

Windows	73
Solaris	73
AIX 5.x	74
Linux	74
Open Secured NSF Files	75
Format Note Subfiles	75
Extract Subfiles from PDF Files	75
Improve Performance for PDFs with Many Small Images	75
Extract Embedded OLE Objects	76
Extract Subfiles from ZIP Files	76
Default File Names for Extracted Subfiles	76
Default File Name for Mail Formats	77
Default File Name for Embedded OLE Objects	78
Chapter 4: Use the HTML Export API	79
Extract Metadata	79
Extract Metadata by Using the API	80
Use the C API	80
Use the COM interface	80
Extract Metadata by Using a Template File	80
Examples	81
\$SUMMARYNN	81
\$SUMMARY	81
\$USERSUMMARY	82
Extract File Format Information	82
Use the C API	83
Use the COM interface	83
Convert Character Sets	83
Determine the Character Set of the Output Text	83
Guidelines for Character Set Conversion	84
Examples of Character Set Conversion	85
Document Character Set Can be Determined	85
Document Character Set Cannot be Determined	85
Set the Character Set During Conversion	86
Set the Character Set During File Extraction from a Container	86
Map Styles	87
Use the C API	87
Use a Template file	88
Use the COM interface	90
Use Style Sheets	90
Display Vector Graphics on UNIX and Linux	91
Search and Highlight Terms	91
Include Revision Information	92
Configure the Revision Title	93
Configure the Revision Style	94
Generate a Revision Summary	95
Extract Text from Text Boxes	95

Convert PDF Files	95
Use the pdf2sr Reader	95
Use a Graphic-Based Reader	96
Use the kppdfldr Reader	97
Use the kppdf2rdr Reader	97
Specify the Graphic-based Reader	97
Convert PDF Files to Raster Images	98
Convert PDF Files to a Logical Reading Order	99
Logical Reading Order and Paragraph Direction	99
Enable Logical Reading Order	100
Use the C API	100
Use the formats_e.ini File	101
Generate a Table of Contents from PDF Bookmarks	102
Disable Bookmark Conversion	102
Convert Invisible Text	103
Toggle Invisible Text	103
Specify Opacity of Invisible Text	103
Convert Rotated Text	104
Control Hyphenation	105
Extract Custom Metadata from PDF Files	106
Convert Spreadsheet Files	106
Convert Hidden Text in Microsoft Excel Files	107
Convert Headers and Footers in Microsoft Excel 2003 Files	107
Specify Date and Time Format on UNIX Systems	107
Convert Very Large Numbers in Spreadsheet Cells to Precision Numbers	108
Extract Microsoft Excel Formulas	108
Set Minimum Image Size	110
Convert Presentation Files	110
Convert Presentation Files to Raster Images	110
Convert Presentation Files to a Logical Reading Order	110
Mitigate Text Wrapping	111
Convert XML Files	111
Configure Element Extraction for XML Documents	111
Modify Element Extraction Settings	112
Use the C API	112
Modify Element Extraction Settings in the kvxconfig.ini File	113
Specify an Element's Namespace and Attribute	115
Add Configuration Settings for Custom XML Document Types	115
Show Hidden Data	116
Hidden Data in Microsoft Documents	116
Toggle Word Comment Settings in the formats_e.ini File	117
Toggle PowerPoint Slide Note Settings in the formats_e.ini File	118
Exclude Japanese Guide Text	118
Source Code Identification	118
Partitioning	119
Configure the Proxy for RMS	120

Chapter 5: Sample Programs	122
Introduction	122
C Sample Programs	122
Compile the Visual Basic Sample Program	123
COM Sample Program	123
tstxtract	124
cnv2html	125
cnv2htmlloop	126
onefile	128
index	128
io_samp	128
htmlini	129
callback	131
jvtree_demo	131
JVTree	132
kvhtmlexport	132
Export Demo	133
Template Wizard	133
Convert Documents to HTML by Using the Template Wizard	134
Change the Output Directory	134
Modify a Template in the Wizard	135
comsamp	138
htmlloop	138
Part 3: C API Reference	139
Chapter 6: File Extraction API Functions	140
KVGetExtractInterface()	140
fpCloseFile()	141
fpExtractSubFile()	142
fpFreeStruct()	143
fpGetMainFileInfo()	144
fpGetSubFileInfo()	145
fpGetSubFileMetaData()	147
fpOpenFile()	149
Chapter 7: File Extraction API Structures	151
KVCredential	151
KVCredentialComponent	152
KVExtractInterface	152
KVExtractSubFileArg	153
KVGetSubFileMetaArg	156
KVMainFileInfo	157
KVMetadataElem	158
KVMetaName	159
KVOpenFileArg	160
KVOutputStream	161

KVSubFileExtractInfo	162
KVSubFileInfo	163
KVSubFileMetaData	166
Chapter 8: HTML Export API Functions	167
KVHTMLGetInterfaceEx()	168
KVHTMLGetInterfaceEx2()	168
fpConfigureRMS()	170
fpConvertStream()	171
fpFileToInputStreamCreate()	173
fpFileToInputStreamFree()	174
fpFileToOutputStreamCreate()	175
fpFileToOutputStreamFree()	176
fpFreePartitionInfoList	177
fpGetAnchor()	178
fpGetConvertFileList()	179
fpGetKvErrorCode	180
fpGetKvErrorCodeEx	180
fpGetPartitionInfoList	181
fpGetStreamInfo()	182
fpGetSummaryInfo()	182
fpInit()	184
fpInitWithLicenseData()	185
fpSetPartitionOn	187
fpSetStyleMapping()	188
fpShutDown()	189
fpValidateTemplate()	190
KVHTMLConfig()	190
KVHTMLConvertFile()	198
KVHTMLEndOOPSession()	200
KVHTMLSetHighlight()	202
KVHTMLSetStyleSheet()	204
KVHTMLStartOOPSession()	205
Chapter 9: HTML Export API Callback Functions	209
Introduction	209
Continue()	209
GetAnchor()	210
GetAuxOutput()	212
UserCB()	213
Chapter 10: HTML Export API Structures	215
ADDOCINFO	216
KVInputStream	216
KVMemoryStream	217
KVOutputStream	218
KVPartitionDimensions	218
KVPartitionInfo	219
KVPartitionInfoList	220

KVPartitionSetOn	221
KVRMSCredentials	221
KVSTR	222
KVStreamInfo	223
KVStructHead	224
KVStyle	224
KVSumInfoElemEx	226
KVSummaryInfoEx	226
KVXConfigInfo	227
KVHTMLCallbacksEx	228
KVHTMLHeadingInfo	229
KVHTMLHighlight	231
KVHTMLInterfaceEx	232
KVHTMLInterfaceEx2	234
KVHTMLOptionsEx	237
KVHTMLTemplateEx	246
KVHTMLTOCOptions	250
KVRevisionMark	252
KV_RM_Title	253
Chapter 11: Enumerated Types	255
Introduction	255
Programming Guidelines	256
ENDocAttributes	256
ENSATableBorder	257
KVCredKeyType	258
KVErrCode	258
KVErrCodeEx	260
KVHTMLStyleSheetType	264
KVHTMLAnchorTypeEx	264
KVHTMLGraphicType	266
KVHeadingCreateOptions	267
KVMetadataType	267
KVMetaNameType	269
KVPartitionStartReason	269
KVSumInfoType	271
KVSumType	272
LPDF_DIRECTION	275
RM_Title_Flag	276
Part 4: COM API Reference	278
Chapter 12: COM Interface Methods and Events	279
Methods	279
Events	279
AddStyleMapping	279
ConvertFileToFile	280

GetFileInfo	280
GetStyleMapping	281
GetSummaryInfo	281
RemoveStyleMapping	282
Unload	282
UpdateFromIniFile	282
HTMLConfig	283
Continue	283
UserCallback	283
Chapter 13: COM Interface Properties	284
adInfo_docAttributes	284
adInfo_docClass	284
adInfo_docFmt	284
adInfo_docVersion	285
bAllowHeadingsInTables	285
bDisplayRelativeFontSize	285
bEnableEmptyRows	285
bForceOutputCharSet	285
bForceSrcCharSet	286
bGenerateURLs	286
bHardPageMakesNewBlock	286
bNbspEmptyCells	286
bNoPictures	287
bPutBlocksInSeparateFiles	287
bRasterizeFiles	287
bRemoveEmptyColumns	288
bRemoveFileNameSpaces	288
bSupportCellSpan	288
bSupportColumnHeadings	288
bSupportColumnWidth	288
bSupportFontFace	289
bSupportRFC1942_cols	289
bSupportRowHeadings	289
bSupportRowSpan	289
bSupportUserFontSizeMapping	289
bTableHTMLForSpreadsheetOnly	290
bTabsToTables	290
bUseDocumentColors	290
bUseDocumentFontInfo	290
CodePage	290
cRedact	291
cReplaceChar	291
cxVectorToRasterXRes	291
cyVectorToRasterYRes	292
dwFlags	293
FontSizeMap_nSize[1...7]	293

headingCreateType	293
InputCharSet	294
lcbBlockSize	294
lcbMaxMemUsage	295
MarkupEnd	295
MarkupStart	295
nCompressionQuality	295
nRowsBeforeSplit	296
nTableBorderWidth	296
NumStyles	296
OutputCharSet	296
OutputLanguageID	297
OutputRasterGraphicType	297
OutputVectorGraphicType	297
pHn_bNoMultiSpaces	297
pHn_bNonZeroIndent	298
pHn_bNoTabs	298
pHn_bMustBeBold	298
pHn_bMustBeItalic	299
pHn_bMustBeUnderlined	299
pHn_fontSizeMax	299
pHn_fontSizeMin	300
pHn_maxParaLen	300
pHn_minParaLen	300
pHn_mSpaceAfter	301
pHn_mSpaceBefore	301
pszAuthor	301
pszBaseURL	301
pszComments	302
pszChunkTemplate	302
pszDefaultOutputDirectory	302
pszEndBlock	302
pszFirstH1End	302
pszFirstH1Start	303
pszH[2..6]HTML	303
pszInputFile	303
pszKeyViewDir	303
pszKeywords	303
pszLastH1End	304
pszLastH1Start	304
pszLastSavedby	304
pszMainBottom	304
pszMainTop	304
pszMainURL	305
pszMiddleH1End	305
pszMiddleH1Start	305
pszPicPath	305

pszPicURL	305
pszRevNumber	306
pszStartBlock	306
pszSubject	306
pszTableHTML	306
pszTemplate	306
pszTitle	307
pszTOC_H[1..6]	307
pszTOCH[1..6]End	307
pszTOCH[1..6]LeafNode	307
pszTOCH[1..6]Start	307
pszUserSummary	308
pszXFile	308
pszXStartBlock	308
pszXEndBlock	308
SATableBorder	309
SrcCharSet	309
StyleSheetType	309
StyleName	309
Timeout	310
Part 5: Appendixes	311
Appendix A: Supported Formats	312
Key to Supported Formats Table	312
Supported Formats	314
Appendix B: Document Readers	392
Key to Document Readers Table	392
Document Readers	394
Appendix C: Character Sets	424
Multibyte and Bidirectional Support	424
Coded Character Sets	432
Appendix D: Extract and Format Lotus Notes Subfiles	438
Overview	438
Customize XML Templates	438
Use Demo Templates	439
Use Old Templates	439
Disable XML Templates	439
Template Elements and Attributes	440
Conditional Elements	440
Control Elements	441
Data Elements	442
Date and Time Formats	445
Lotus Notes Date and Time Formats	445
KeyView Date and Time Formats	446

Appendix E: Export Tokens	451
Appendix F: File Format Detection	454
Introduction	454
Extract Format Information	454
Determine Format Support	454
Refine Detection of Text Files	455
Change the Amount of File Data to Read	455
Change the Percentage of Allowed Non-ASCII Characters	456
Use the File Extension for Detection	456
Allow Consecutive NULL Bytes in a Text File	456
Translate Format Information	457
Distinguish Between Formats	457
Determine a Document Reader	458
Category Values in formats_e.ini	458
Appendix G: Files Required for Redistribution	462
Core Files	462
Support Files	463
Document Readers and Writers	465
Appendix H: Password Protected Files	473
Supported Password Protected File Types	473
Open Password Protected Container Files	474
Export Password Protected Files	474
Appendix I: Microsoft Rights Management Service Protected Files	476
Microsoft Azure Rights Management Service	476
RMS Credentials	477
Supported Formats	477
Microsoft Office Files	477
Implemented as pFile	478
PDF Files	480
Restricted Permission Messages	481
 Send documentation feedback	 482

Part 1: Overview of HTML Export

This section provides an overview of the Micro Focus IDOL KeyView Export SDK and describes how to use the C and COM implementation of the API.

- [Introducing HTML Export](#)
- [Getting Started](#)

Chapter 1: Introducing HTML Export

This guide is for developers who want to incorporate Micro Focus KeyView HTML conversion technology into their applications using a C and COM development environment. It is intended for readers who are familiar with HTML and C and COM.

• Overview	15
• Features	15
• Platforms, Compilers, and Dependencies	16
• Windows Installation	18
• UNIX Installation	19
• Package Contents	20
• License Information	20
• Directory Structure	22
• Definition of Terms	24

Overview

HTML Export is part of the KeyView Export SDK. It enables you to convert virtually any document, spreadsheet, presentation, or graphic into high-fidelity HTML. Incorporating this technology into your web-based applications enables your end-users to access a document even if they do not have the appropriate plug-in or native application. With HTML Export, you control the content, structure, and format of the HTML output using either easily customized templates, or the flexible and robust APIs.

The Export SDK supports a number of programming environments, such as Visual Basic, Java, .NET and Delphi and runs on all popular operating system platforms including Windows, Linux, Solaris, and IBM AIX.

The Export SDK is part of the KeyView suite of products. KeyView provides high-speed text extraction, conversion to web-ready HTML and well-formed XML, and high-fidelity document viewing.

Features

- Dynamically convert word processing, spreadsheet, presentation, and graphics files into web-ready, 4.0-compliant HTML.
- Export supports over 300 formats in 70 languages.
- Convert files either in-process or out of process. Out-of-process conversion ensures the stability and robustness of the calling application if a corrupt document causes an exception or causes the conversion process to fail.

- You can extract files embedded within files by using the File Extraction API, and then convert them by using the Export API.
- Use redirected input/output. You can provide an input stream that is not restricted to file system access.
- Export automatically recognizes the file format being converted and uses the appropriate reader. Your application does not need to rely on file name extensions to determine the file format.
- Create heading levels in the output file either by using the structure in the source document or by allowing Export to automatically generate a structure based on document properties, such as font or font attributes.
- Use callbacks to control aspects of the conversion process, such as file naming and the insertion of scripts.
- Manage memory allocation to optimize speed and performance of application.
- Insert predefined HTML markup at specific points in the output stream.
- Create navigable documents by automatically inserting links into target HTML. You can also break large documents into multiple linked web pages.
- Apply Cascading Style Sheets (CSS) to improve the fidelity of the output.
- Map paragraph and character styles in word processing documents to any markup that you specify in the output.
- Control the resolution of rasterized vector graphics to optimize storage requirements or image quality.
- Select the target format for converted graphics, including GIF, JPEG, CGM, PNG, WMF, and SVG on Windows, and JPEG and SVG on Unix and Linux.
- Define the background, colors, and fonts used in the final HTML document, or maintain the source document's existing attributes.

Platforms, Compilers, and Dependencies

This section lists the supported platforms, supported compilers, and software dependencies for the KeyView software.

Supported Platforms

- CentOS 7 x86, x64, and AArch64
- IBM AIX L6.1 PowerPC 32-bit and 64-bit
- IBM AIX L7.1 PowerPC 32-bit and 64-bit
- macOS 10.13 or later on 64-bit Apple-Intel architecture
- macOS 11 or later on Apple M1.

- Microsoft Windows Server 2012 x64
- Microsoft Windows Server 2016 x64
- Microsoft Windows Server 2019 x64
- Microsoft Windows 8 x86 and x64
- Microsoft Windows 10 x64
- Oracle Solaris 10 SPARC
- Oracle Solaris 10 x86 and x64
- Red Hat Enterprise Linux 6 x86 and x64
- Red Hat Enterprise Linux 7 x64
- Red Hat Enterprise Linux 8 x64
- SuSE Linux Enterprise Server 11 x86 and x64
- SuSE Linux Enterprise Server 12 x64
- SuSE Linux Enterprise Server 15 x64

Supported Compilers

Platform	Architecture	Compiler Name	Compiler Version
Microsoft Windows	x86	cl	Microsoft 32-bit C/C++ Optimizing Compiler for x86 Version 17 (Visual Studio 2012) to Version 19 (Visual Studio 2019)
	x64	cl	Microsoft C/C++ Optimizing Compiler for x64 Version 17 (Visual Studio 2012) to Version 19 (Visual Studio 2019).
Sun Solaris	x86 64-bit	Sun Studio 12	Sun C 5.9 SunOS_i386 Patch 124868-01 2007/07/12
	SPARC 64-bit	Sun Studio 11	Sun C 5.8 Patch 121015-06 2007/10/03
Linux	x86	gcc / g++	4.1.0 to 4.9.2
	x64	gcc / g++	4.1.0 to 4.9.2
IBM AIX	Power	xlc_r / cc_r	IBM XL C/C++ Enterprise Edition V8.0
macOS	Apple-Intel 64-bit	LLVM	Apple LLVM 5.1 (clang-503.0.40) (based on LLVM 3.4svn)
	Apple M1	LLVM	Apple LLVM 12.0.0 (clang 1200.0.32.28).

Supported Compilers for Java Components

Component	Compiler
Java components	Java 7

Software Dependencies

Some KeyView components require specific third-party software:

- Java Runtime Environment (JRE) or Java Software Developer Kit (JDK) version 7 or 8 is required for Java API and graphics conversion in Export SDK.
- Outlook 2002 or later is required to process Microsoft Outlook Personal Folders (PST) files using the MAPI-based reader (`psts_r`). The native PST readers (`pstxs_r` and `pstns_r`) do not require Outlook.

NOTE: You must install an edition of Microsoft Outlook (32-bit or 64-bit) that matches the KeyView software. For example, if you use 32-bit KeyView, install 32-bit Outlook. If you use 64-bit KeyView, install 64-bit Outlook.

If the editions do not match, KeyView returns `Error 32: KVErrror_PSTAccessFailed` and an error message from Microsoft Office Outlook is displayed: `Either there is a no default mail client or the current mail client cannot fulfill the messaging request. Please run Microsoft Outlook and set it as the default mail client.`

- Lotus Notes or Lotus Domino is required for Lotus Notes database (NSF) file processing. The minimum requirement is 6.5.1, but version 8.5 is recommended.
- Microsoft Visual C++ 2019 Redistributables (Windows only).

Windows Installation

To install the SDK on Windows, use the following procedure.

To install the SDK

1. Run the installation program, `KeyViewProductNameSDK_VersionNumber_OS.exe`, where *ProductName* is the name of the product, *VersionNumber* is the product version number, and *OS* is the operating system.

For example:

`KeyViewExportSDK_12.9_Windows_X86_64.exe`

The installation wizard opens.

2. Read the instructions and click **Next**.

The License Agreement page opens.

3. Read the agreement. If you agree to the terms, click **I accept the agreement**, and then click **Next**.

The Installation Directory page opens.

4. Select the directory in which to install the SDK. To specify a directory other than the default, click , and then specify another directory. After choosing where to install the SDK, click **Next**.

The Pre-Installation Summary opens.

5. Review the settings, and then click **Next**.

The SDK is installed.

6. Click **Finish**.

UNIX Installation

To install the SDK, use one of the following procedures.

To install the SDK from the graphical interface

- Run the installation program and follow the on-screen instructions.

To install the SDK from the console

1. Run the installation program from the console as follows:

```
./KeyViewExportSDK_VersionNumber_Platform.exe --mode text
```

where:

VersionNumber is the product version.

Platform is the name of the platform.

2. Read the welcome message and instructions and press `Enter`.

The first page of the license agreement is displayed.

3. Read the license information, pressing `Enter` to continue through the text. After you finish reading the text, and if you accept the agreement, type `y` and press `Enter`.

You are asked to choose an installation folder.

4. Type an absolute path or press `Enter` to accept the default location.

The Pre-Installation summary is displayed.

5. If you are satisfied with the information displayed in the summary, press `Enter`.

The SDK is installed.

Package Contents

The Export installation contains:

- Libraries and executable files necessary for converting source documents into high-quality, web-ready HTML (see [Files Required for Redistribution, on page 462](#)).
- The include files that define the functions and structures used by the application to establish an interface with Export (see the `include` directory for HTML Export).
- The Java API implemented in the `com.verity.api.export` package contained in the `KeyView.jar` file.
- Several sample programs that demonstrate Export's functionality.
- Sample images that can be used as navigation buttons and background textures in your output.
- Template files that enable you to set conversion options without modifying at the API level. They can be used to generate a wide range of output, from highly-stylized user-defined HTML to stripped-down, text-only output suitable for use with an indexing engine.
- Sample style sheet: `WordStyle.css` (for word processing documents).

License Information

Your license key controls whether you have the full version of the KeyView SDK, or a trial version. It also determines whether the following advanced features are enabled:

- Advanced character set detection with the character set detection library (`kvlangdetect`).
- Advanced document readers:
 - Microsoft Outlook Personal Folders (PST) readers (`pstsr`, `pstnsr`, and `pstxsr`)
 - Lotus Notes database (NSF) reader (`nsfsr`)
 - Mailbox (MBX) reader (`mbxsr`)
- Processing of documents protected by Microsoft RMS encryption.

If you obtain a new license key from Micro Focus, you must update the licensing information that you pass to KeyView. See [Pass License Information to KeyView](#).

Enable Advanced Document Readers

To enable advanced readers, you must obtain an appropriate license key from Micro Focus and pass the license key to KeyView as described in [Pass License Information to KeyView](#).

If you are enabling the MBX reader in an existing installation of Export, in addition to updating the license key, change the parameter `208=em1` to `208=mbx` in the `formats_e.ini` file.

Pass License Information to KeyView

To provide license information to KeyView, do one of the following:

- Provide the license information through the API. Micro Focus recommends using this approach.
- Provide the license information as a text file named `kv.lic`. In earlier versions of KeyView, license information had to be stored in a file and included in the `bin` folder with the KeyView libraries. The ability to provide license information as a file has been deprecated and might be removed in future. You should no longer include license information in your application as a file. Micro Focus recommends that you pass license information to KeyView through the API instead.

If you have an evaluation version of KeyView and purchase a full version of the SDK, or you are adding a document reader (for example, the PST reader), you must update the license information that you pass to KeyView.

To provide license information through the API

- In the C API, provide license information when you initialize KeyView by calling `fpInitWithLicenseData()`.
- In the Java API, provide license information to KeyView when you instantiate the `HtmlExport` object.

To provide license information as a file

1. Open or create the license key file, `kv.lic`, in a text editor. The file must be saved in the same directory as the KeyView libraries, and must contain your organization name and license key.

```
COMPANY NAME  
XXXXXXXX-XXXXXXXX-XXXXXXXX-XXXXXXXX
```

2. Replace the text `COMPANY NAME` with the company name that appears at the top of the License Key Sheet provided by Micro Focus. Enter the text exactly as it appears in the document.
3. Replace the characters `XXXXXX-XXXXXXXX-XXXXXXXX-XXXXXXXX` with the appropriate license key from the License Key Sheet provided by Micro Focus. The license key is listed in the **Key** column in the **Standalone Products** table. The key is a string that contains 31 characters, for example, `2TQD22D-2M6FV66-2KPF23S-2GEM5AB`. Enter the characters exactly as they appear in the document, including the dashes, but do not include a leading or trailing space.

4. The finished `kv.lic` file looks similar to the following:

```
Autonomy  
24QD22D-2M6FV66-2KPF23S-2G8M59B
```

5. Save the file.

Directory Structure

The following table describes the directories created during the HTML Export installation. The variable *install* is the path name of the Export installation directory (for example, /usr/autonomy/KeyviewExportSDK on UNIX, or C:\Program Files\Autonomy\KeyviewExportSDK on Windows). On UNIX, the HTML Export directory is named /htmlxpt.

The variable *OS* is the operating system for which the SDK is installed. For example, the bin directory on a standard 32-bit Windows installation would be located at C:\Program Files\Autonomy\KeyviewExportSDK\WINDOWS\bin.

HTML Export installed directory structure

Directory	Description
<i>install</i> \OS\bin	Contains the libraries, executables for sample programs, the Java program (kvraster.class), the Java applet (kvvector.jar), the format detection file, formats_e.ini, the license key file (kv.lic), and a number of other supporting files.
<i>install</i> \OS\lib	(Solaris installations only) Contains the redistributable libstlport.so.1 library, which is required to run KeyView on Solaris platforms.
<i>install</i> \dotnet\sample	The HtmlConvFileToFile.cs C# sample program demonstrating the .NET interface.
<i>install</i> \htmlxport\docs	Contains the converted version of the sample word processing, spreadsheet, and presentations files.
<i>install</i> \htmlxport\guide	Contains the <i>HTML Export C and COM Programming Guide</i> and <i>HTML Export Java Programming Guide</i> in HTML and PDF format.
<i>install</i> \htmlxport\include	Contains the header files for HTML Export.
<i>install</i> \htmlxport\programs\bin	Contains the executable files for the Visual Basic sample program called Export Demo.
<i>install</i> \htmlxport\programs\callback	Contains the C source code and supporting files for a sample program that demonstrates how user callbacks can dynamically shape the HTML conversion.
<i>install</i> \htmlxport\programs\cnv2html	Contains the C source code for a sample program that creates a single HTML file. The executable for this sample program is in the bin directory.
<i>install</i>	Contains the C source code for a sample program that creates

HTML Export installed directory structure, continued

Directory	Description
cnv2htmlloop	a single HTML file out of process.
<i>install</i> \htmllexport\programs\comsamp	Contains the Visual Basic source code and supporting files for a sample program that demonstrates the use of the COM interface.
<i>install</i> \htmllexport\programs\ExportDemo	Contains the source code for a sample Visual Basic program. The executable for this program is in the bin directory. The Export Demo is available through the Start menu.
<i>install</i> \htmllexport\programs\htmlini	Contains the C source code and supporting files for a sample program that uses template files to set the conversion options.
<i>install</i> \htmllexport\programs\htmlloop	Contains a Visual C++ sample program that uses the Microsoft Foundation Classes (MFC) to provide out-of-process HTML conversion using the COM automation server.
<i>install</i> \htmllexport\programs\images	Contains the background graphics and navigation buttons used by the template files.
<i>install</i> \htmllexport\programs\index	Contains the C source code and supporting files for a sample program that produces text-only HTML.
<i>install</i> \htmllexport\programs\ini	Contains the template files used to set the conversion options in the C API.
<i>install</i> \htmllexport\programs\io_samp	Contains the C source code and supporting files for a sample program that demonstrates how to input a stream by providing a simple wrapper around the ANSI C interface fread(), fopen(), and so on.
<i>install</i> \htmllexport\programs\jstree	Contains the C source code and supporting files for a sample program that employs JavaScript to produce an expandable table of contents in a frame-based HTML output file.
<i>install</i> \htmllexport\programs\jvtree	Contains the C source code and supporting files for a sample program that uses the JVTtree Java applet in creating an expandable table of contents in a frame-based HTML output file.
<i>install</i> \htmllexport\programs\jvtree_demo	C code sample that creates a frame-based HTML stream using the JVTtree Java applet to display the table of contents.
<i>install</i> \htmllexport\programs\pdfini	Contains the configuration file used to extract custom metadata from PDF documents.
<i>install</i> \htmllexport\programs\tempout	The default output directory for converted files. Contains a sample style sheet.

HTML Export installed directory structure, continued

Directory	Description
<i>install</i> \htmlexport\programs\ tstextract	Contains the C source code and supporting files for a sample program that demonstrates the File Extraction interface.
<i>install</i> \htmlexport\programs\wizard	Contains the source code and supporting files for the Visual Basic program HTML Export Template Wizard.
<i>install</i> \htmlexport\rel_notes	Contains the <i>HTML Export Release Notes</i> in HTML and PDF format.
<i>install</i> \javaapi\ini	Contains the template files used with the Java API.
<i>install</i> \javaapi\javadoc	Contains the Javadoc for the Java API.
<i>install</i> \javaapi\sample	Contains the source files and sample programs for the Java API.
<i>install</i> \pdfexport\cnv2pdf	Contains the C source code for a sample program that creates a PDF file. The executable for this sample program is in the bin directory.
<i>install</i> \pdfexport\include	Contains the header files for PDF Export. For more information, see the <i>PDF Export Programming Guide</i> .
<i>install</i> \testdocs	Contains sample word processing, spreadsheet, and presentation files that you can use to test HTML Export's options. You might also find this directory useful when testing your own applications.

Definition of Terms

The following are specialized terms used throughout the guide.

anchor	HTML markup that defines both anchors and hyperlinks. An anchor is a named place in a document to which other documents can form a link. Anchors use the HTML anchor tags (<a>) to facilitate navigation within a document.
block	All source document content (including subheadings) associated with Heading Level 1. Export identifies and/or generates blocks from the input stream for the implementation of the your HTML markup.
block chunk	All source document content associated with Heading Levels 2 through 6. Chunks are subdivisions of blocks. You can supply specific HTML markup for the different levels of

chunk	block chunks.
callback	A function optionally supplied by your application and called from the Export API. For example, callbacks allow your application to monitor the progress of the conversion process dynamically.
stream	Transmission of a file's content between memory and disk in a continuous flow.
token	The vehicle for conveying specific types of information to and from the API during the conversion process. Tokens are placeholders for markup that appears in the output. See Export Tokens, on page 451 .

Chapter 2: Getting Started

This section provides an overview of the HTML Export SDK and describes how to use the C and COM implementations of the API.

- [HTML Export Reference Implementation](#)26
- [Architectural Overview](#)28
- [Memory Abstraction](#)29
- [Enhance Performance](#)30
- [Convert Files](#)30
- [Convert Files Out of Process](#)31
- [Subfile Extraction](#)38
- [Set Conversion Options](#)39
- [Use the Export Demo Program](#)42
- [Use the C-Language Implementation of the API](#)46
- [Use the COM Implementation of the API](#)49

HTML Export Reference Implementation

The KeyView Export SDK includes a reference implementation that demonstrates how to export documents to HTML. The reference implementation includes source code for a library named `libkvhtmlexport`, and a sample program named `kvhtmlexport`.

The `libkvhtmlexport` library is written in C++ and provides a simple interface to HTML Export. You can:

- use the library in your own product, if it provides the functionality you need.
- modify the library to provide the functionality you desire.
- look at the source code to help you learn how to use the C API, which provides much greater flexibility.

The library uses partition information provided by KeyView to provide the following features out-of-the-box:

- A "print" view for word-processor documents. This creates a web page containing a representation of the original document, which is easy to read because it uses the correct page widths and margins.
- A "tabbed" view for spreadsheet files. This shows spreadsheets using a familiar tabbed interface, with one worksheet on each tab.
- A "list" view for presentations. This displays multiple slides, arranged in a vertical column one after another, on a single web page.

- A "full screen" view for presentations. This displays one slide at a time. You can navigate between slides using the arrow keys on your keyboard or the scroll wheel on your mouse.

The following image shows a Microsoft Word document that has been exported to HTML, being displayed in a web browser:

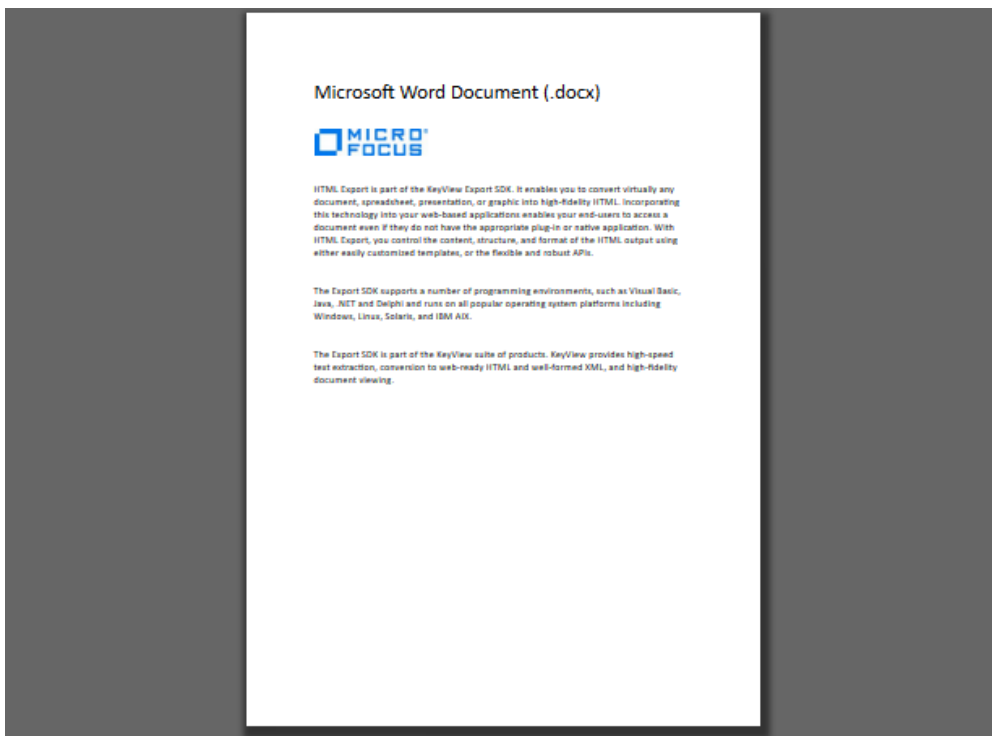

The following image shows a Microsoft Excel workbook that has been exported to HTML, being displayed in a web browser. Additional sheets can be viewed by clicking the tabs at the bottom of the window.

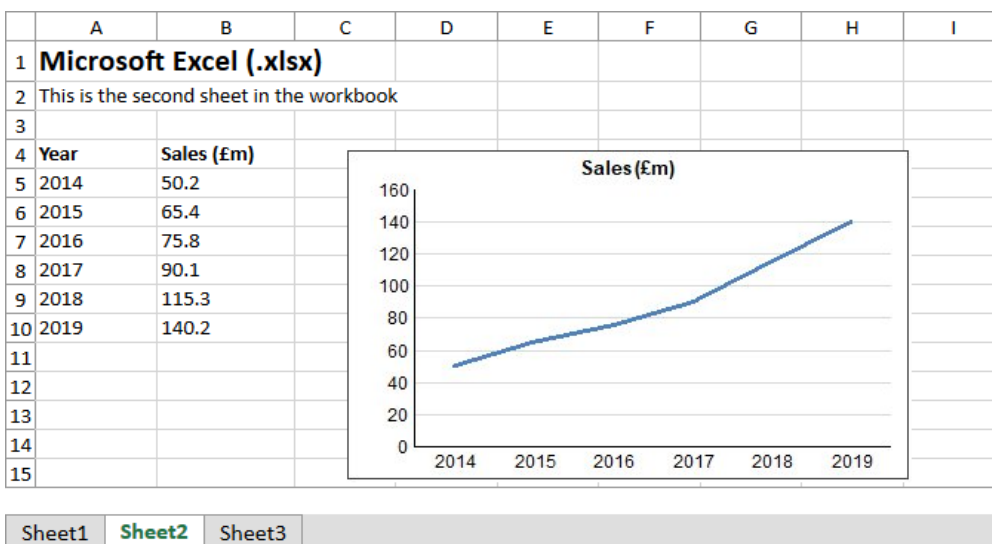

The interface for the library is in `htmlexport/libkvhtmlexport/include/libkvhtmlexport.h`, and the implementation is in `htmlexport/libkvhtmlexport/src/`.

The kvhtmlexport sample program uses the library to convert documents to HTML. The source code is provided in `htmlexport/libkvhtmlexport/sample/src/`. A compiled binary is also provided, in the `PLATFORM/bin` folder, so that you can try it without having to build it yourself. For more information, see [kvhtmlexport](#).

NOTE: The compiled binary for kvhtmlexport has an embedded trial license, which expires approximately five months after release.

Architectural Overview

The general architecture of the KeyView HTML conversion technology is the same across all supported platforms and is illustrated in the following diagram:

HTML Export Architecture

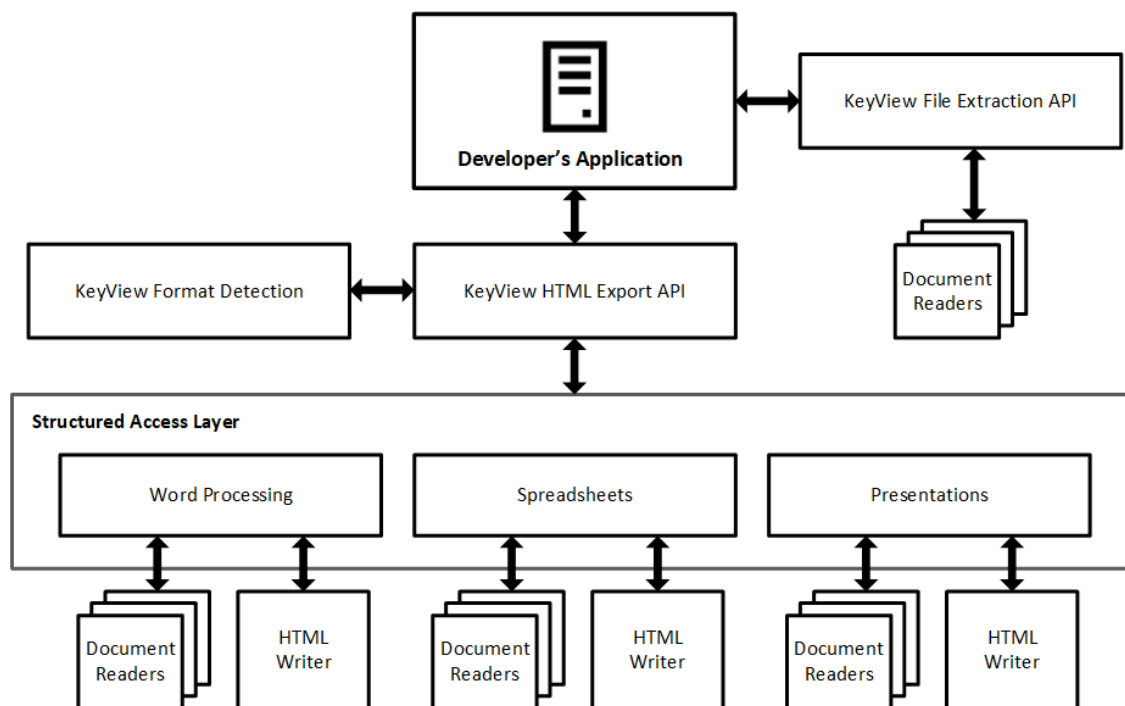

Each component is described in the following table.

Architectural Components

Component	Description
Developer's Application	The developer's application interfaces directly with the HTML Export API through either a C, COM, or Java implementation.
File Extraction	The File Extraction API opens a file and extracts the file's subfiles so that the subfiles are available for conversion. See Use the File Extraction API, on page 55 .

Architectural Components, continued

Component	Description
API	
HTML Export API	The HTML Export API exposes the functionality of HTML Export and controls all other HTML Export modules during the conversion process.
Format Detection Module	The format detection module determines the file type of the source file, which enables the HTML Export interface to load the appropriate structured access layer module and document reader. See File Format Detection, on page 454 .
Structured Access Layer	The structured access layer contains three modules: one for word processing, one for spreadsheets, and one for presentations and graphics. Information from the format detection module determines which access layer module operates at this stage of the conversion. The structured access layer performs the following: <ol style="list-style-type: none">1. Loads the appropriate document reader.2. Processes the data stream from the document reader.3. Determines table of contents entries.4. Sends the stream to the appropriate HTML writer.5. Accepts the HTML stream from the HTML writer.6. Generates the HTML output file with a table of contents, metadata, and the document's contents, and sends it to the HTML Export interface.
Document Reader	Each document reader reads a specific file format and sends a text stream of the document to the structured access layer. Word processing readers return a <i>token stream</i> to the structured access layer. A token stream contains the document contents and messages (tokens) that precede the content and identify the type of information that follows them. Each reader is loaded as required by the structured access layer. See Document Readers and Writers, on page 465 for a complete list of document readers.
HTML Writers	Each HTML writer accepts a text stream or token stream from the structured access layer and generates an equivalent HTML stream that is sent back to the structured access layer. The structured access layer then generates the output file. See Document Readers and Writers, on page 465 for a list of format writers.

Memory Abstraction

All dynamic memory allocations in Export modules are abstracted through a C interface. This memory allocation interface is defined in the `KVMemoryStream` structure in `kvtypes.h`. See [KVMemoryStream, on page 217](#). You can override all memory allocations by providing a C structure that contains pointers to functions identical in nature to their standard ANSI C counterpart.

The [callback, on page 131](#) sample program demonstrates Export memory management features.

Enhance Performance

KeyView is designed for optimal performance out of the box. However, there are some parameters that you can adjust to improve performance specifically for your system.

File Caching

To reduce the frequency of I/O operations, and consequently improve performance, the KeyView readers load file data into memory. The readers then read the data from the cache rather than the physical disk. You can configure the amount of memory used for file caching through the `formats_e.ini` file. Generally, when you increase the memory, performance improves.

By default, KeyView uses a maximum of 1 MB of memory for each thread, assuming a thread contains only one instance of `pContext` that is returned from the session initialization (`fplnit()` or `fplnitWithLicenseData()`). If the file data is larger than 1 MB, up to 1 MB of data is cached and the data beyond 1 MB is read from disk. The minimum amount of memory that can be used for file caching is 64 KB.

To determine a reasonable value, divide the maximum amount of memory you want KeyView to use for file caching by the total number of threads. For example, if you want KeyView to use a maximum of 50 MB of memory and have 10 threads, set the value to 5 MB.

To modify the memory allocated for file caching, change the value for the following parameter in the `[DiskCache]` section of the `formats_e.ini` file:

```
DiskCacheSize=1024
```

The value is in kilobytes. If this parameter is not set or is set to 0 (zero), the minimum value of 64 KB is used.

The `formats_e.ini` file is in the directory `install\OS\bin`, where `install` is the path name of the Export installation directory and `OS` is the name of the operating system.

Convert Files

KeyView Export SDK enables you to *convert* many different types of documents to HTML. Converting is the process of extracting the text from a document without the application-specific markup, and applying HTML markup. The conversion process can also include the following:

- Extracting subfiles to expose all subfiles for conversion. See [Subfile Extraction, on page 38](#).
- Setting conversion options to determine the content, structure, and appearance of the HTML output. See [Set Conversion Options, on page 39](#).
- Extracting the file's format to detect a file's format, and report the information to the API, which in turn reports the information to the developer's application. See [Extract File Format Information, on page 82](#).

- Extracting metadata (document properties) from a file. See [Extract Metadata, on page 79](#).
- Converting character sets to control the character set of both the input and the output text. See [Convert Character Sets, on page 83](#).
- Implementing callbacks to control the conversion while it is in progress. See [HTML Export API Callback Functions, on page 209](#).

You can use one of the following methods to convert documents:

- Use the Export Demo sample program. This Visual Basic program demonstrates most Export API functionality and is the easiest way to get started. See [Use the Export Demo Program, on page 42](#).
- Use the C-language implementation of the API from your C or C++ application. See [Use the C-Language Implementation of the API, on page 46](#).
- Use the COM implementation of the API from your Visual Basic, Delphi, or J++ or C application (32-bit Windows platforms only). See [Use the COM Implementation of the API, on page 49](#).
- Use the C and COM sample programs. See [Sample Programs, on page 122](#).

NOTE: Micro Focus strongly recommends that you convert documents *out of process*. During out-of-process conversion, Export runs independently from the calling application. Out-of-process conversions protects the stability of the calling application in the rare case when a malformed document causes Export to fail. [Convert Files Out of Process, below](#).

Convert Files Out of Process

Export can run independently from the calling application. This is called *out of process*. Out-of-process conversions protect the stability of the calling application in the rare case when a malformed document causes Export to fail. You can also run Export in the same process as the calling application. This is called *in process*. However, it is strongly recommended you convert documents out of process whenever possible.

The Export out-of-process framework uses a client-server architecture. The calling application sends an out-of-process conversion request to the Service Request Broker in the main Export process. The Broker then creates, monitors, and manages a Servant process for the request—each request is handled by one independent Servant process. Data is exchanged between the application thread and the Servant through TCP/IP sockets. The source data is sent to the Servant process as a data stream or file, converted in the Servant, and then returned to the application thread. At that point, the application can either terminate the Servant process or send more data for conversion.

Multiple conversion requests can be sent from multiple threads in the calling application simultaneously. All requests sent from one thread are processed by the Servant mapped to that thread. In other words, each thread can only have one Servant to process its conversion requests.

Any standard conversion errors generated by the Servant are sent to the application.

NOTE: Currently, the main Export process and Servant processes must run on the same host.

The following are requirements for running Export out of process:

- Internet Protocol (TCP/IP) must be installed
- Multithreaded processing must be supported on the operating system platform
- The user application must be built with a multithreaded runtime library

The following functions run in process or out of process:

fpConvertStream()	fpGetConvertFileList()
fpGetSummaryInfo()	fpSetStyleMapping()
KVHTMLConfig()	KVHTMLConvertFile()
KVHTMLSetStyleSheet()	

When converting out of process, these functions must be called after the call to start an out-of-process session and before the call to end an out-of-process session.

Other HTML Export functions, the File Extraction functions, and the COM methods always run in-process.

Configure Out-of-Process Conversions

Although most components of the out-of-process conversion are transparent, the following parameters are configurable:

- File-size threshold/temporary file location
- Conversion time-out
- Listener port numbers and time-out
- Connection time-out and retry
- Servant process name

These parameters are defined internally, but you can override the default by defining the parameter in the `formats_e.ini` file. The `formats_e.ini` file is in the directory `install\OS\bin`, where `install` is the path name of the Export installation directory and `OS` is the name of the operating system.

To set the parameters, add the following section to the `formats_e.ini` file:

```
[KVExportOOPOptions]
TempFileSizeMark=
TempFilePath=
WaitForConvert=
WaitForConnectionTime=
ListenerPortList=
ListenerTimeout=
ConnectRetryInterval=
ConnectRetry=
ServantName=
```

Each parameter is described in the following table.

The default values for these parameters are set to ensure reasonable performance on most systems. If you are processing a large number of files, or running Export on a slow machine, you might need to increase some of the time-out and retry values.

Parameters for Out-of-Process Conversion

Parameter	Description
TempFileSizeMark unit = megabytes default=10	The <i>file-size threshold</i> . If the input file received by the Servant is larger than this value, temporary files are created to store the data. The directory in which the temporary files are stored is defined by the TempFilePath parameter. If the file received is smaller than this value, the data is stored in memory in the Servant. This applies only when the input is a stream.
TempFilePath type = file path default = current working directory	The directory in which temporary files are stored. Temporary files are created when you use the fpConvertStream() API, and the input file surpasses the file-size threshold (TempFileSizeMark). If the Servant cannot access the file path, an error is generated. This applies only when converting in stream mode.
WaitForConvert unit = seconds default = 1800 range = 30~3600	The length of time to wait for a Servant to convert a file. If the conversion is not completed within the specified time, the error code "wait for child process failed" is generated.
WaitForConnectionTime unit = seconds default = 180 range = 15~600	The length of time to wait for the Servant to connect to the application thread after the application has sent a conversion request to the Broker. If the Servant does not connect within the specified time, the error code "wait for child process failed" is generated. If there are many Servant processes running simultaneously, you might need to increase this value.
ListenerPortList type = integer default = 9985, 9986, 9987, 9988, 9989	The TCP/IP port number used for communication between the calling application and the Servant. You can specify a single port number, or a series of numbers separated by commas.
ListenerTimeout unit = seconds default = 10 range = 5~30	The length of time to wait for the Servant listener thread to get a process ID from the Servant after the connection is established. If the ID is not obtained within the specified time, the error code "wait for child process failed" is generated. During this time, no other Servant can connect with the application.
ConnectRetryInterval unit = microseconds default = 0.1	The length of time to wait after a Servant has failed to connect to the application before it retries the connection. A Servant might be unable to connect because the application is waiting for another Servant to send a process ID.

Parameters for Out-of-Process Conversion, continued

Parameter	Description
range = 50000~500000	To calculate the <i>total retry interval</i> , the value set here is added to the platform-specific TCP retry value (on Windows, this is 1 second).
ConnectRetry type = integer default = 120 range = 30~600	<p>The number of attempts the Servant makes to connect to the calling application. This value and the total retry interval determine the total delay time. The total delay is calculated as follows:</p> $\text{ConnectRetryInterval} + \text{platform-specific_TCP_retry_value} * \text{ConnectRetry}$ <p>For example, if the <code>ConnectRetryInterval</code> is set to 2 seconds, and the Export process is running on Windows (the default TCP retry value on Windows is 1 second), the total delay would be:</p> $2 + 1 * 120 = 360$ <p>The Servant would attempt to connect to the application every 3 seconds for 120 attempts for a total of 360 seconds.</p>
ServantName type = string default = servant	The name of the Servant process. To move the Servant to another location, enter a fully qualified path.

Run Export Out of Process—Overview

To convert files out of process

1. If required, set parameters for the out-of-process conversion in the `formats_e.ini` file. See [Configure Out-of-Process Conversions, on page 32](#).
2. Initialize an Export session.
3. If you are using streams, create an input stream.
4. Define the conversion options.
5. Initialize an out-of-process session.
6. Convert the input and/or call other functions that can run out of process.
7. Shut down the out-of-process session.
8. Repeat Step 3 to Step 7 for additional files.
9. Terminate the out-of-process session and the Servant process.
10. Shutdown the Export session.

Recommendations

- To ensure that multithreaded conversions are thread-safe, you must create a unique context pointer for every thread by calling `fpInIt()` or `fpInItWithLicenseData()`. In addition, threads must not share context pointers, and the same context pointer must be used for all API calls in the same thread. Creating a context pointer for every thread does not affect performance because the context pointer uses minimal resources.
- All functions that can run in out-of-process mode must be called within the out-of-process session (that is, after the call to initialize the out-of-process session and before the call to end the out-of-process session).
- When terminating an out-of-process session, persist the Servant process by setting the Boolean flag `bKeepServantAlive` in the `KVHTMLEndOOPSession()` function or `endOOPSession` method. If the Servant process remains active, subsequent conversion requests are processed more quickly because the Servant process is already prepared to receive data. Only terminate the Servant when there are no more out-of-process requests.
- To recover from a failure in the Servant process, start a new out-of-process session. This creates a new Servant process for the next conversion.

Run Export Out of Process

The `cnv2htmlloop` sample program demonstrates how to run Export out of process.

To convert files out of process in the C API

1. If required, set parameters for the out-of-process conversion in the `formats_e.ini` file. See [Configure Out-of-Process Conversions, on page 32](#).
2. Declare instances of the following types and assign values to the members as required:

`KVHTMLTemplateEx`
`KVHTMLOptionsEx`
`KVHTMLHeadingInfo`
`KVHTMLTOCOptions`

See [HTML Export API Structures, on page 215](#) for more information.
3. Load the KVHTML library and obtain the `KVHTMLInterfaceEx` entry point by calling `KVHTMLGetInterfaceEx()`.

See [KVHTMLGetInterfaceEx\(\), on page 168](#).
4. Initialize an Export session by calling `fpInIt()` or `fpInItWithLicenseData()`. See [fpInIt\(\)](#) or [fpInItWithLicenseData\(\)](#).
5. If you are using streams for the input and output source, follow these steps; otherwise, proceed to [Step 6](#):
 - a. Create an input stream (`KVInputStream`) by calling `fpFileToInputStreamCreate()`. See [fpFileToInputStreamCreate\(\), on page 173](#).

- b. Create an output stream (KVOutputStream) by calling `fpFileToOutputStreamCreate()`. See [fpFileToOutputStreamCreate\(\)](#), on page 175.
 - c. Proceed to [Step 6](#).
 6. Set up an out-of-process session by calling `KVHTMLStartOOPSession()`. See [KVHTMLStartOOPSession\(\)](#), on page 205. This function performs the following:
 - Initializes the out-of-process session.
 - Specifies the input stream or file. If you are using an input file, set `pFileName` to the file name, and set `pInputStream` to `NULL`. If you are using an input stream, set `pInputStream` to point to `KVInputStream`, and set `pFileName` to `NULL`.
 - Passes conversion options from the `KVHTMLTemplateEx`, `KVHTMLOptionsEx`, and `KVHTMLTOCOptions` data structures.
 - Creates a Servant process.
 - Establishes a communication channel between the application thread and the Servant.
 - Sends the data to the Servant.See the sample code in [Example—KVHTMLStartOOPSession](#), below, and [KVHTMLStartOOPSession\(\)](#), on page 205.
7. Convert the input and generate the output files by calling `KVHTMLConvertFile()` or `fpConvertStream()`. The `KVHTMLTemplateEx`, `KVHTMLOptionsEx`, and `KVHTMLTOCOptions` structures are passed in the call to `KVHTMLStartOOPSession()`, and should be `NULL` in the conversion call. A conversion function can be called only once in a single out-of-process session. See [KVHTMLConvertFile\(\)](#), on page 198, and [fpConvertStream\(\)](#), on page 171.
8. Terminate the out-of-process session by calling `KVHTMLEndOOPSession()`. The Servant ends the current conversion session, and releases the source data and session resources. See sample code in [Example—KVHTMLEndOOPSession](#), on the next page, and [KVHTMLEndOOPSession\(\)](#), on page 200.
9. If you used streams, free the memory allocated for the input stream and output stream by calling the `fpFileToInputStreamFree()` and `fpFileToOutputStreamFree()` functions. See [fpFileToInputStreamFree\(\)](#), on page 174 and [fpFileToOutputStreamFree\(\)](#), on page 176.
10. Repeat [Step 5](#) to [Step 9](#) for additional files.
11. After all files are converted, terminate the out-of-process session *and* the Servant process by calling `KVHTMLEndOOPSession()` and setting the Boolean to `FALSE`.
12. After the out-of-process session and Servant are terminated, shut down the Export session by calling `fpShutDown()`. See [fpShutDown\(\)](#), on page 189.

Example—KVHTMLStartOOPSession

The following sample code is from the `cnv2htmlLoop` sample program:

```
/* declare OOP startsession function pointer */
KVHTML_START_OOP_SESSION fpKVHTMLStartOOPSession;
/* assign OOP startsession function pointer */
```

```

fpKVHTMLStartOOPSession = (KVHTML_START_OOP_SESSION)mpGetProcAddress
                          (hKVHTML, "KVHTMLStartOOPSession");
if(!fpKVHTMLStartOOPSession)
{
    printf("Error assigning KVHTMLStartOOPSession pointer\n");
    (*KVHTMLInt.fpFileToInputStreamFree)(pKVHTML, &Input);
    (*KVHTMLInt.fpFileToOutputStreamFree)(pKVHTML, &Output);
    mpFreeLibrary(hKVHTML);
    return 7;
}
/*****START OOP SESSION *****/
if(!(*fpKVHTMLStartOOPSession)(pKVHTML,
    &Input,
    NULL,
    &HTMLTemplates,      /* Markup and related variables */
    &HTMLOptions,        /* Options */
    NULL,                /* TOC options */
    &oopServantPID,
    &error,
    0,
    NULL,
    NULL))
{
    printf("Error calling fpKVHTMLStartOOPSession \n");
    (*KVHTMLInt.fpShutDown)(pKVHTML);
    mpFreeLibrary(hKVHTML);
    return 9;
}
    
```

Example—KVHTMLEndOOPSession

The following sample code is from the `cnv2htmlloop` sample program:

```

/* declare endsession function pointer */
KVHTML_END_OOP_SESSION  fpKVHTMLEndOOPSession;
/* assign OOP endsession function pointer */
fpKVHTMLEndOOPSession = (KVHTML_END_OOP_SESSION)mpGetProcAddress
                          (hKVHTML, "KVHTMLEndOOPSession");
if(!fpKVHTMLEndOOPSession)
{
    printf("Error assigning KVHTMLEndOOPSession pointer\n");
    (*KVHTMLInt.fpFileToInputStreamFree)(pKVHTML, &Input);
    (*KVHTMLInt.fpFileToOutputStreamFree)(pKVHTML, &Output);
    mpFreeLibrary(hKVHTML);
    return 8;
}
/*****END OOP SESSION, DO NOT KEEP SERVANT ALIVE *****/
if(!(*fpKVHTMLEndOOPSession)(pKVHTML,
    FALSE,
    &error,
    
```

```
    0,  
    NULL,  
    NULL))  
{  
    printf("Error calling fpKVHTMLEndOOPSession \n");  
    (*KVHTMLInt.fpShutDown)(pKVHTML);  
    mpFreeLibrary(hKVHTML);  
    return 10;  
}
```

Subfile Extraction

To convert a file, you must first determine whether the source file contains any subfiles (attachments, embedded objects, and so on). A file that contains subfiles is called a *container* file. Compressed files (such as Zip), mail messages with attachments (such as Microsoft Outlook Express), mail stores (such as Microsoft Outlook Personal Folders), and compound documents with embedded OLE objects (such as a Microsoft Word document with an embedded Excel chart) are examples of container files.

If the file is a container file, the container must be opened and its subfiles extracted by using the *File Extraction API*. The extraction process is done repeatedly until all subfiles are extracted and exposed for conversion. After a subfile is extracted, you can use the HTML Export API to convert the file.

If a file is not a container, you should pass it directly to the HTML Export API for conversion without extraction.

See [Use the File Extraction API, on page 55](#) for more information.

Convert Outlook Email without Using the Extraction API

Micro Focus strongly recommends that you convert all container files, including Microsoft Outlook files, by using the File Extraction API. However, you can convert Outlook email messages (MSG) directly by using the Export API and the MSG reader (msgsr).

NOTE: The MSG reader only extracts the message body of an MSG file. Attachments are not extracted.

To convert MSG files by using the MSG reader, add the following to the `formats_e.ini` file (TRUE is case-sensitive):

```
[ContainerOptions]  
bConvertMSG=TRUE
```

Set Conversion Options

Conversion options are parameters that determine the content, structure, and appearance of the HTML output. For example, you can specify:

- the markup inserted at the beginning and end of specific HTML blocks
- whether a heading is included in the table of contents
- the output character set
- the resolution at which graphics are converted.

Set Conversion Options by Using the API

You set conversion options by modifying the following data structures:

- [KVHTMLTemplateEx](#)
- [KVHTMLOptionsEx](#)
- [KVHTMLHeadingInfo](#)
- [KVHTMLTOCOptions](#)

These data structures are then passed into functions in the KeyView Export API, such as:

- [fpConvertStream\(\)](#)
- [KVHTMLConvertFile\(\)](#)
- [KVHTMLStartOOPSession\(\)](#)

Explore Conversion Options with the Sample Programs

To make it easier to explore the conversion options, HTML Export includes some sample configurations in the form of initialization (.ini) files. These are read by the [htmlini](#) sample program (you must supply the .ini file path as a command-line argument). The sample program reads the configuration, and converts your input file into HTML using the options you set, by passing them into the API. This lets you try out conversion options without programming.

You can use a text editor to customize the configuration files. In general, a section name refers to the structure containing an option, and a parameter name matches an element of that structure. For example:

```
[KVHTMLOptionsEx]
OutputCharSet=KVCS_SJIS
bForceOutputCharSet=TRUE
```

This sets the OutputCharSet and bForceOutputCharSet elements in the [KVHTMLOptionsEx](#) structure.

NOTE: To create valid HTML, an initialization file *must* define at least two structures: KVHTMLTemplateEx and KVHTMLOptionsEx. Additionally, if you enter markup in the template files that is not compliant with HTML standards, HTML Export inserts the markup into the output file unchanged. This might result in a malformed HTML file.

Templates

The template files for the C API implementation are in the directory `install\htmllexport\programs\ini`, where *install* is the path name of the Export installation directory. The following templates are provided:

Template	Description
Arabic (bidi_arabic.ini)	<ul style="list-style-type: none"> Based on the default template (default.ini). The Arabic character set is defined in the template. <dir="rtl"> added to the Body tag to indicate that the text is read from right to left.
Cascading style sheet (css_ex.ini)	<p>This template writes style sheet information to an external Cascading Style Sheet (CSS) file or reads the information from an existing CSS file. This makes the HTML output significantly smaller because the information is not stored within the output file. It also allows you to use the same style sheet for many conversions.</p> <p>See Use Style Sheets, on page 90 and Use Style Sheets with htmlini, on page 130 for more information on using an external CSS file.</p>
Default (default.ini)	<ul style="list-style-type: none"> Segments word processing documents, spreadsheets, and presentations into multiple files according to the document's heading levels. Creates two frames. The table of contents (based on the source document's heading levels and page breaks) appears in the left frame. The document contents associated with the table of contents entry selected in the left frame appears in the right frame. Inserts Previous and Next buttons at the end of each block. Supports URLs. Supports headers, footers, footnotes, and endnotes. Converts graphics to JPEG with the original size preserved. Converts presentation slides to HTML as individual JPEG files.
Hebrew (bidi_hebrew.ini)	<ul style="list-style-type: none"> Based on the default template (default.ini). The Hebrew character set is defined in the template. <dir="rtl"> added to the Body tag to indicate that text is read from right to left.
Low bandwidth	This template is useful when you need to provide information to a mobile

Template	Description
lowband.ini)	workforce that might not always have access to fast connections. <ul style="list-style-type: none"> • Creates text-only HTML. • Suppresses the source document's embedded graphics.
Multiple files with three frames (logotoc.ini)	<ul style="list-style-type: none"> • Segments word processing documents, spreadsheets, and presentations into multiple files according to the document's heading levels. • Creates three frames. A corporate logo is displayed in the top left frame. The table of contents (based on source document heading levels and page breaks) appears in the bottom left frame, and the HTML files appear in the right frame. • Inserts Previous and Next links at the end of each block. • Supports URLs.
No frills (nofrills.ini)	<ul style="list-style-type: none"> • Creates a single HTML file. • Supports URLs. • Maintains the source document's fonts and styles. • Does not create a table of contents. • Does not list the source document's metadata.
PDF bookmarks in a frame (pdfframe.ini)	This template is optimized to display PDF bookmarks in a separate frame. <ul style="list-style-type: none"> • Segments a PDF file into two HTML files; one contains the table of contents (based on the bookmarks in the PDF file), and the other contains the document text. • Creates two frames. The table of contents appears in the left frame, and the document appears in the right frame. • Forces the output character set to UTF-8. • Does not insert Back to Top, Previous, or Next links. See Convert PDF Files, on page 95 for more information on generating a table of contents from bookmarks in a PDF file.
Single file with table of contents (onefiletoc.ini)	This template is useful when you want to print the document. <ul style="list-style-type: none"> • Creates a single HTML file. • Creates a table of contents at the top of the HTML document. • Uses worksheet names to create the table of contents entries for spreadsheets. If worksheet names do not exist in the source document, "Sheet1," "Sheet2," "Sheet3," and so on are used. • Uses slide titles to create the table of contents entries for presentations. If slide titles do not exist in the source document, "slide 1," "slide 2," "slide 3,"

Template	Description
	<p>and so on are used.</p> <ul style="list-style-type: none">• Lists all metadata (Title, Subject, Author, Comments, and so on).• Converts graphics to JPEG with the original resolution preserved.• Converts presentation slides to HTML as individual JPEG files.
Style mapping (wordstyle.ini)	<p>This template demonstrates how to map paragraph and character styles in a word processing document to arbitrary markup (including CSS, XML, or HTML). Using style mapping, you can use external Cascading Style Sheet (CSS) files to define styles used in the HTML, alter the structure of a document, delete content, or replace content with a specified character (redact).</p> <p>See Map Styles, on page 87.</p>
UNIX web server (defunix.ini)	<ul style="list-style-type: none">• Based on the default template (default.ini).• Converts embedded graphics or presentations to either JPEG or HTML Export's Java target. See Display Vector Graphics on UNIX and Linux, on page 91.

Use the Export Demo Program

The easiest way to get started with Export is to become familiar with its capabilities through the Visual Basic sample program, Export Demo. Export Demo is for Windows only.

The source code for the program is in the directory `install\htmlexport\programs\ExportDemo`, where `install` is the path of the Export installation directory.

The output options that control the look of the output files are predefined in Export Demo and cannot be changed in the user interface. Export Demo uses a small sample of the options available in the Export API.

The Template Wizard sample program is an example of a Visual Basic program that does allow the user to control some of the output options with template files. See [Template Wizard, on page 133](#). You can use the sample documents in the directory `install\testdocs` to experiment with converting different file formats.

When you start the program, the following dialog appears:

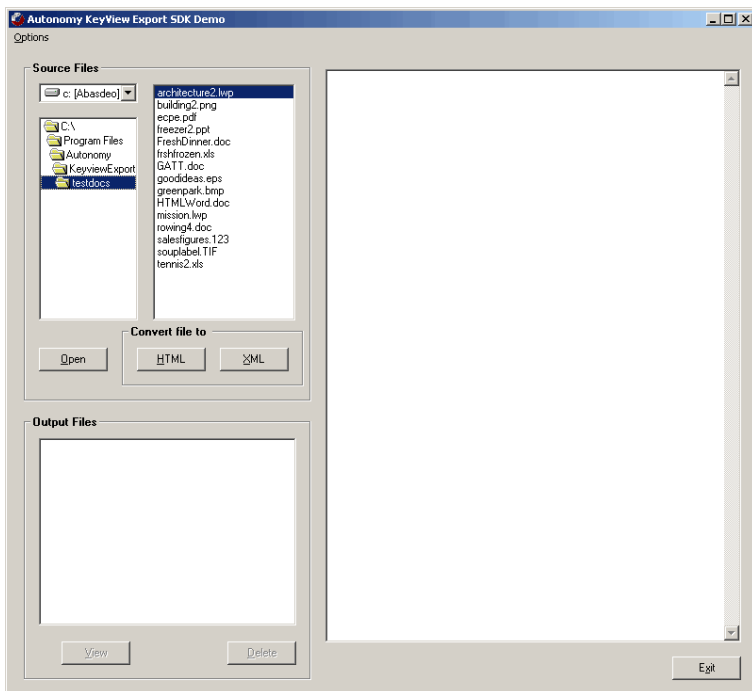

NOTE: XML conversion using XML Export is available in Export Demo if you have XML Export installed. If you do not have XML Export installed, the **XML** button is disabled.

Change Input/Output Directories

If HTML Export is installed in the default directory, the output and input directories are automatically set.

The default location for source files is the directory `install\testdocs`.

The default location for output files is the directory `install\htmlexport\programs\tempout`.

If HTML Export is installed in a directory other than the default, you are prompted to select an output and input directory when you first start Export Demo.

To change the default directories for the source and output files

1. Select **Options > Set Directories**. The following dialog appears:

Export Demo: Setting Directories

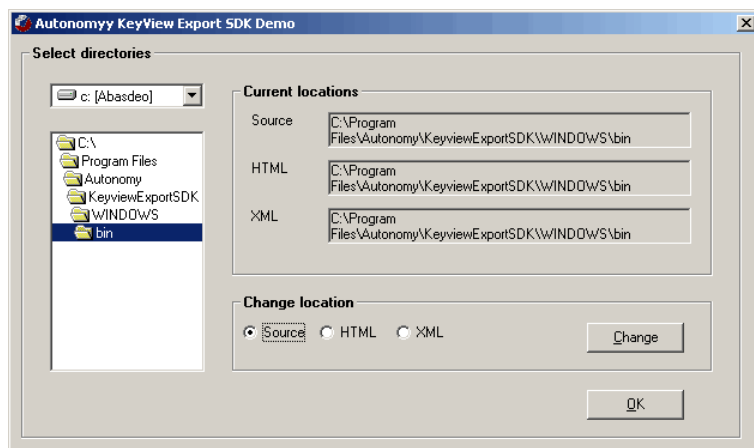

2. From the tree view, select the drive letter and directory for the source or output files.
3. In **Change Location**, select which files are stored in the directory, either **Source** or **HTML**.
4. Click **Change**. The **Current Locations** fields are updated with the new selection.
5. Follow the same procedure for the other file types. When you are finished, click **OK**.

Set Configuration Options

With HTML Export, you can configure options prior to the document conversion by using the `KVHTMLConfig()` function. Export Demo demonstrates this function, and allows you to:

- Specify a PDF reader.
- Specify whether rotated text in a PDF file is displayed in its original position or at the bottom of the page.

Convert PDF Files

In Export Demo, PDF documents can be converted in one of two ways:

- generate HTML output by using the basic PDF reader (`pdfsr`)
- generate a raster image for each page of the PDF file by using a graphic-based PDF reader (`kppdfldr` or `kppdf2ldr`). See [Convert PDF Files to Raster Images, on page 98](#).

Export Demo provides an option to select the type of reader you want to use to convert PDF documents. By default, the basic reader (`pdfsr`) is used to convert PDF documents.

To specify that the graphic-based reader be used to convert PDF documents

1. Ensure that Export Demo is not running.
2. Set the appropriate configuration file options. See [Use a Graphic-Based Reader, on page 96](#).
3. Start the Export Demo program.
4. Select **Options > HTML Config > Set Hifi**.

NOTE: You can also convert PDF documents to a logical reading order by using the pdfsr PDF reader. This feature is demonstrated in the `cnv2html` sample program. See [Convert PDF Files to a Logical Reading Order, on page 99](#).

Convert Rotated Text

In HTML Export, you can specify how rotated text is displayed in the HTML output. By default, rotated text in a file is displayed in its original position, at the original font size, and at zero degrees rotation. Because the text is the original size, but might be displayed in a smaller space, the text might overlap adjacent text in the HTML output. You use the text rotation configuration option to avoid this problem. If this option is set, rotated text is displayed at the bottom of the page on which it appears. See [Convert Rotated Text, on page 104](#). Currently, this configuration option applies only to PDF files.

To specify that rotated text be displayed at the bottom of the page on which it appears, select **Options > HTML Config > Set Text Rotate**.

Convert Files

To convert a single file

1. Select **Options > Convert > Single file**.
2. Select the document from the file list, and then click **HTML** in the **Convert file to** pane.

To convert files in a directory

1. Select **Options > Convert > Entire directory**.
2. Click **HTML** in the **Convert directory to** pane.

To view a converted file, double-click the output file in the **Output Files** pane, or select the output file, and then click **View**. The converted file is displayed in the view pane:

Export Demo: Converting Files

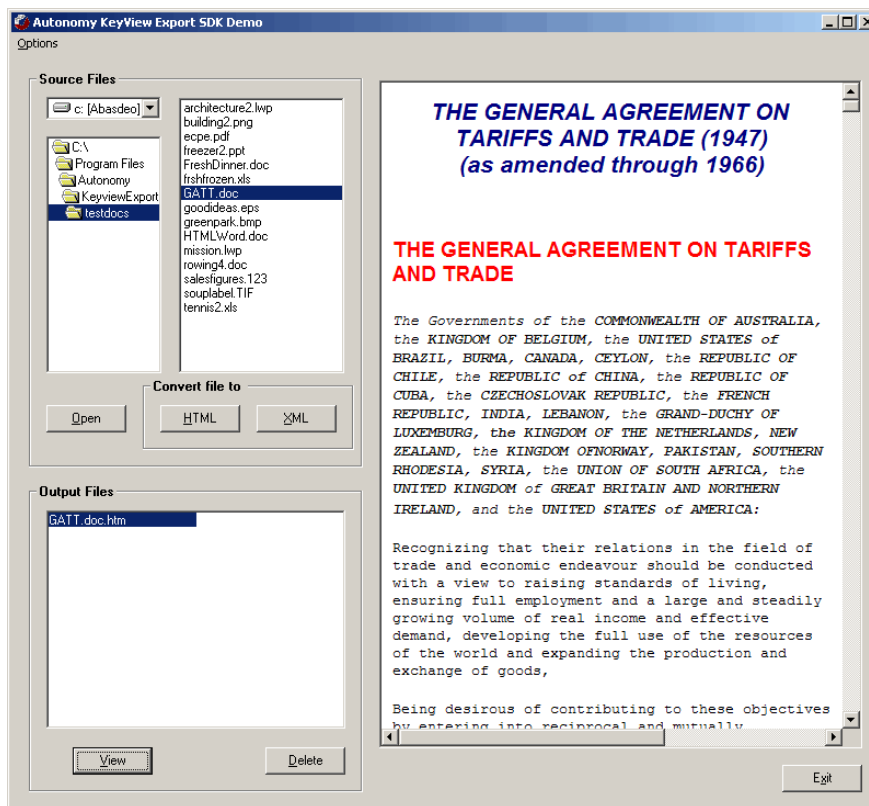

To view the original document, select the document from the file list, and then click **Open**. If you have an application on your system associated with the file, the file is displayed in that application.

To delete output files, select the file in the **Output Files** pane and click **Delete**.

Use the C-Language Implementation of the API

The C-language implementation of the API is divided into the following function suites:

- [File Extraction API Functions, on page 140](#)—Open and extract subfiles in a container file. These functions also extract metadata and file format information, and control character set conversion on extraction.
- [HTML Export API Functions, on page 167](#)—Extract format information (metadata, character set, and format), create an input/output stream from a file, and open, convert, and close the stream.
- [HTML Export API Callback Functions, on page 209](#)—Controls the conversion while it is in progress.

Input/Output Operations

In the Export API, the source input and target output can be either a physical file accessed through a file path, or a *stream* created from a data source. A stream is a C structure that contains pointers to I/O functions similar in nature to their standard ANSI C counterparts. This structure is passed to Export functions in place of the standard input source. See [KVInputStream, on page 216](#) and [KVOutputStream, on page 218](#).

You can create an input stream either by using the `fpFileToInputStreamCreate()` function, or by using code similar to the example code in the `io_samp` sample program. You can create an output stream by using the `fpFileToOutputStreamCreate()` function. These functions assign C equivalent I/O functions to `fpOpen()`, `fpRead()`, `fpSeek()`, `fpTell()`, and `fpClose()`. See [fpFileToInputStreamCreate\(\), on page 173](#) and [fpFileToOutputStreamCreate\(\), on page 175](#).

Convert Files

To use the C-language implementation of the API

1. Develop the HTML markup and tokens to be assigned to the required members of a declared instance of `KVHTMLTemplateEx`.

If you use markup in the structure that is not compliant with HTML standards, HTML Export inserts the markup into the output file unchanged. This might result in a malformed HTML file.

2. Declare instances of the following types and assign values to the members as required:

```
KVHTMLTemplateEx  
KVHTMLOptionsEx  
KVHTMLHeadingInfo  
KVHTMLTOCOptions
```

See [HTML Export API Structures, on page 215](#) for more information.

3. Load the KVHTML library and obtain the `KVHTMLInterfaceEx` entry point by calling `KVHTMLInterfaceEx`. See [KVHTMLGetInterfaceEx\(\), on page 168](#).
4. Initialize an Export session by calling `fpInit()` or `fpInitWithLicenseData()`. The function's return value, `pContext`, is passed as the first argument to all other Export functions. See [fpInit\(\)](#) or [fpInitWithLicenseData\(\)](#).
5. Pass the context pointer from [fpInit\(\)](#) or [fpInitWithLicenseData\(\)](#) and the address of a structure containing pointers to the File Extraction API functions in the call to `KVGetExtractInterface()`. See [KVGetExtractInterface\(\), on page 140](#).
6. If you are using streams for the input and output source, follow these steps; otherwise, proceed to [Step 7](#):
 - a. Create an input stream (`KVInputStream`) either by calling `fpFileToInputStreamCreate()`, or by using code similar to the example code in the `io_samp` sample program. [fpFileToInputStreamCreate\(\), on page 173](#).

- b. Create an output stream (KVOutputStream) either by calling `fpFileToOutputStreamCreate()`, or by using code similar to the example code in the `io_samp` sample program. [fpFileToOutputStreamCreate\(\), on page 175.](#)
 - c. Proceed to [Step 7.](#)
7. Declare the input stream or file name in the `KVOpenFileArg` structure. See [KVOpenFileArg, on page 160.](#)
8. Open the source file by calling `fpOpenFile()` and passing the `KVOpenFileArg` structure. This call defines the parameters necessary to open a file for extraction. See [fpOpenFile\(\), on page 149.](#)
9. Determine whether the source file is a container file (contains subfiles) by calling `fpGetMainFileInfo()`. See [fpGetMainFileInfo\(\), on page 144.](#)
10. If the call to `fpGetMainFileInfo()` determined the source file is a container file, proceed to [Step 11](#); otherwise, proceed to [Step 14.](#)
11. Determine whether the subfile is itself a container (contains subfiles) by calling `fpGetSubFileInfo()`. See [fpGetSubFileInfo\(\), on page 145.](#)
12. Extract the subfile by calling `fpExtractSubFile()`. See [fpExtractSubFile\(\), on page 142.](#)
13. If the call to `fpGetSubFileInfo()` determined the subfile is a container file, repeat [Step 6](#) through [Step 12](#) until all subfiles are extracted; otherwise, proceed to [Step 14.](#)
14. Setup an out-of-process session by calling `KVHTMLStartOOPSession()`. See [KVHTMLStartOOPSession\(\), on page 205.](#)
15. Convert the input and generate the output files by calling `KVHTMLConvertFile()` or `fpConvertStream()`. The structures `KVHTMLTemplate`, `KVHTMLOptions`, and `KVHTMLTOOptions` are defined in the call to `KVHTMLStartOOPSession()`, and should be `NULL` in the conversion call. A conversion function can be called only once in a single out-of-process session. See [KVHTMLConvertFile\(\), on page 198,](#) and [fpConvertStream\(\), on page 171.](#)
16. If you are using callbacks, they are called while the conversion process is underway. If required, you can specify alternate paths and file names for output files, including using the table of content entries for the file names. See [HTML Export API Callback Functions, on page 209.](#)
17. If you are converting additional files, terminate the out-of-process session by calling `KVHTMLEndOOPSession()` and setting the Boolean to `TRUE`. The Servant ends the current conversion session, and releases the source data and session resources.

If you are not converting additional files, terminate the out-of-process session *and* the Servant process by calling `KVHTMLEndOOPSession()` and setting the Boolean to `FALSE`. See [KVHTMLEndOOPSession\(\), on page 200.](#)
18. Close the file by calling `fpCloseFile()`. See [fpCloseFile\(\), on page 141.](#)
19. If you used streams, free the memory allocated for the input stream and output stream by calling the functions `fpFileToInputStreamFree()` and `fpFileToOutputStreamFree()`. See [fpFileToInputStreamFree\(\), on page 174](#) and [fpFileToOutputStreamFree\(\), on page 176.](#)
20. Repeat [Step 6](#) through [Step 18](#) for additional source files.
21. Shutdown the Export session by calling `fpShutDown()`. See [fpShutDown\(\), on page 189.](#)

Multithreaded Conversions

To ensure that multithreaded conversions are thread-safe, you must create a unique context pointer for every thread by initializing the Export session with `fpInit()` or `fpInitWithLicenseData()`. In addition, threads must not share context pointers, and the same context pointer must be used for all API calls in the same thread. Creating a context pointer for every thread does not affect performance because the context pointer uses minimal resources.

For example, your code should have the following logic for one thread:

```
fpInit()
    KVGetExtractInterface()
    fpFileToInputStreamCreate()
    fpFileToOutputStreamCreate()
    fpOpenFile()
    fpGetMainFileInfo()          /* container file */
    fpGetSubFileInfo()
    fpExtractSubFile
    KVHTMLStartOOPSession()
    fpConvertStream()
    KVHTMLEndOOPSession(bKeepServantAlive TRUE)
    fpCloseFile()
fpFileToInputStreamFree()
fpFileToOutputStreamFree()
    set input/output file
    fpOpenFile()
    fpGetMainFileInfo()          /* not a container file */
    KVHTMLStartOOPSession()
    KVHTMLConvertFile()
    KVHTMLEndOOPSession(bKeepServantAlive TRUE)
    fpCloseFile()
    ...
fpShutdown()
```

Use the COM Implementation of the API

The COM implementation of HTML Export is only applicable to Win32 environments. It is supported in both out-of-process (`htmserv.exe`) and in-process (`htmserv.dll`) versions. Programming with either interface is identical. The out-of-process version provides a more robust HTML conversion, but at the expense of making out-of-process calls. To use either version of the COM implementation, you must register the COM component. Both components support self-registration and self-unregistration. You can only register one COM component.

To use the COM Automation Server

1. Register the COM server by using one of the following methods:

- To register the out-of-process COM server, run:

```
install\OS\bin\htmserv.exe -RegServer
```

- To register the in-process COM server, run:

```
regsvr32.exe install\OS\bin\htmserv.dll
```

- To unregister the out-of-process COM server, run:

```
install\OS\bin\htmserv.exe -UnRegServer
```

and then reboot the machine.

- To unregister the in-process COM server, run:

```
regsvr32.exe -u install\OS\bin\htmserv.dll
```

where *install* is the path name of the Export installation directory.

The `regsvr32.exe` is a Microsoft Windows program used to register in-process COM objects and is stored in the `install\OS\bin` directory.

2. Confirm the following entry is in the Windows registry:

```
\\HKEY_CLASS_ROOT\VerityHtmServ.Application
```

3. Create an instance of the COM object. See the `comsamp` sample for an example.

4. Specify the source file by using the `pszInputFile` property.

5. Specify the location of the HTML Export libraries by using the `pszKeyViewDir` property.

6. Use the properties and methods described in [COM Interface Methods and Events, on page 279](#) and [COM Interface Properties, on page 284](#).

Sample Implementation

The following code, which is found in the sample Visual Basic program named `comsamp`, demonstrates how to use the properties, methods, and events of the ActiveX Controls from within Visual Basic.

Define the `htmserv` Object

The sample code will not function unless you first define the `htmserv` object in Visual Basic.

To define the object for Visual Basic 6

1. Select **References...** from the **Project** menu.
2. Search available references for "HTML Export COM Server Library," and select it.
3. If the HTML Export COM Server Library is unavailable, follow the registering instructions in [Use the COM Implementation of the API, on the previous page](#).

Sample Code

1. Declare the variable MyRef as an instance of htmserv (the HTML Export COM server):

```
Dim WithEvents MyRef As htmserv
```

2. Specify the source file by setting the input file property pszInputFile:

```
Private Sub Convert_Click()  
MyRef.pszInputFile = File1.Path & "\" & File1.FileName
```

3. Define the GetSummaryInfo method and metadata properties:

```
Dim nTotal As Long  
Dim nValid As Long  
Dim nType As Long  
Dim nVal As Long  
Dim szVal As String  
Dim szUserVal As String  
...  
On Error GoTo Handler  
Call MyRef.GetSummaryInfo(3, nTotal, nValid, nType, nVal, szVal, szUserVal)  
MsgBox szUserVal & " = " & szVal
```

4. Call the ConvertFileToFile method:

```
Convert:  
nRet = MyRef.ConvertFileToFile("c:\temp\temp.htm")  
WebBrowser1.Navigate ("c:\temp\temp.htm")  
Exit Sub
```

5. The comsmp sample program specifies the default directory for source files as the C:\Program Files\Autonomy\KeyviewExportSDK\testdocs directory, and the directory in which binaries are stored as the C:\Program Files\Autonomy\KeyviewExportSDK\>OS\bin directory, where OS is the name of the operating system. To change these directories to match your installation, set the Path property to the location of the testdocs directory, and set the pszKeyViewDir property to the location of the HTML Export binary files:

```
Private Sub Form_Load()  
Set MyRef = New htmserv  
Dir1.Path = "C:\myinstall\testdocs"  
MyRef.pszKeyViewDir = "C:\myinstall\bin"  
End Sub
```

6. Implement the Continue event that is called by HTML Export:

```
Private Function MyRef_Continue(ByVal PercentDone As Long) As Long  
ProgressBar1.Value = PercentDone  
MyRef_Continue = True  
ProgressBar1.Refresh  
End Function
```

See [Continue, on page 283](#) for more information.

7. Implement the UserCallback event:

```
Private Function MyRef_UserCallback(ByVal szUserString As String) As String
    MsgBox (szUserString)
    MyRef_UserCallback = "Output this text to HTML"
End Function
```

See [UserCallback](#), on page 283 for more information.

The code below demonstrates an alternate way to initiate an instance of the COM server:

```
Dim HTM As Object
Set HTM = CreateObject("VerityHtmServ.Application")
```

where HTM is the COM Automation Server object.

Part 2: Use the Export API

This section explains how to perform some basic tasks using the File Extraction and Export APIs, and describes the sample programs. It contains the following chapters:

- [Use the File Extraction API](#)
- [Use the HTML Export API](#)
- [Sample Programs](#)

Chapter 3: Use the File Extraction API

This section describes how to extract subfiles from a container file by using the File Extraction API.

• Introduction	55
• Extract Subfiles	56
• Extract Images	58
• Recreate a File's Hierarchy	58
• Extract Mail Metadata	60
• Extract Subfiles from Outlook Files	67
• Extract Subfiles from Outlook Express Files	67
• Extract Subfiles from Mailbox Files	67
• Extract Subfiles from Outlook Personal Folders Files	68
• Extract Subfiles from Lotus Domino XML Language Files	71
• Extract Subfiles from Lotus Notes Database Files	72
• Extract Subfiles from PDF Files	75
• Extract Embedded OLE Objects	76
• Extract Subfiles from ZIP Files	76
• Default File Names for Extracted Subfiles	76

Introduction

To convert a file, you must first determine whether the file contains any subfiles (attachments, embedded OLE objects, and so on). A file that contains subfiles is called a *container* file. A container file has a main file (parent) and subfiles (children) embedded in the main file.

The following are examples of container files:

- Archive files such as ZIP, TAR, and RAR.
- Mail messages such as Outlook (MSG) and Outlook Express (EML).
- Mail stores such as Microsoft Outlook Personal Folders (PST), Mailbox (MBX), and Lotus Notes database (NSF).
- PDF files that contain file attachments.
- Compound documents with embedded OLE objects such as a Microsoft Word document with an embedded Excel chart.

NOTE: [Document Readers, on page 392](#) indicates which formats are treated as container files and are supported by the File Extraction API.

The subfiles might also be container files, creating a file hierarchy of multiple levels. For example, an MSG file (the root parent) might contain three attachments:

- a Microsoft Word document that contains an embedded Microsoft Excel spreadsheet.
- an AutoCAD drawing file (DWG).
- an EML file with an attached Zip file, which in turn contains four archived files.

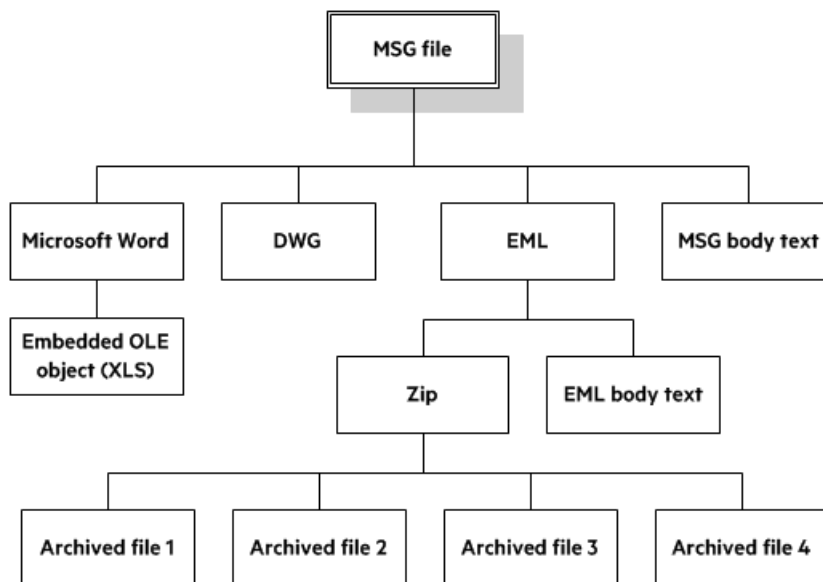

NOTE: The parent MSG file contains four first-level children. The body text of a message file, although not a standalone file in the container, is considered a child of the parent file.

Extract Subfiles

To convert all files in a container file, you must open the container and extract its subfiles by using the *File Extraction API*. The extraction process is done repeatedly until all subfiles are extracted and exposed for conversion. After a subfile is extracted, you can call Export API functions to convert the file.

If you want to convert a container file and its subfiles to a single file, you must extract all files from the container, convert the files, and then append each converted output file to its parent.

To extract subfiles

1. Pass the context pointer from `fpInit()` or `fpInitwithLicenseData()` and the address of a structure that contains pointers to the File Extraction API functions in the call to [KVGetExtractInterface\(\)](#).
2. Declare the input stream or file name in the [KVOpenFileArg](#) structure.
3. Open the source file by calling [fpOpenFile\(\)](#) and passing the [KVOpenFileArg](#) structure. This call

defines the parameters necessary to open a file for extraction.

4. Determine whether the source file is a container file (that is, whether it contains subfiles) by calling `fpGetMainFileInfo()`.
5. If the call to `fpGetMainFileInfo()` determined that the source file is a container file, proceed to step 6; otherwise, convert the file.
6. Determine whether the subfile is itself a container (that is, whether it contains subfiles) by calling `fpGetSubFileInfo()`.
7. Extract the subfile by calling `fpExtractSubFile()`.
8. If the call to `fpGetSubFileInfo()` determined that the subfile is a container file, repeat step 2 through step 7 until all subfiles are extracted and the lowest level of subfiles is reached; otherwise, convert the file.

Sanitize Absolute Paths

When you extract a subfile from a container and write it to disk, you specify an extract directory and a path to extract the file to.

To set the path, you might use the path in the container file that you are extracting from, as returned from the function `fpGetSubFileInfo()`, on page 145. However, if the path is an absolute path, the file could be created outside the directory you have chosen as the extract directory. Your application might then contain a vulnerability that could be exploited to write files to unexpected locations in the file system. This section discusses some KeyView features that can help you secure your application by sanitizing paths.

KeyView always sanitizes relative paths that you pass in when extracting files, so that the paths remain within the extract directory you specify. For example, KeyView does not allow the use of "." to move outside the extract directory.

KeyView can update absolute paths so that they remain within the extract directory. You can instruct KeyView to sanitize absolute paths programmatically (through the API), or by setting a parameter in the configuration file.

The following table shows the effect on some example paths.

Requested path	Path of extracted file (not sanitized)	Path of extracted file (sanitized)
file.txt	<i>extractDir/file.txt</i>	<i>extractDir/file.txt</i>
dir/file.txt	<i>extractDir/dir/file.txt</i>	<i>extractDir/dir/file.txt</i>
../file.txt	<i>extractDir/file.txt</i>	<i>extractDir/file.txt</i>
/dir/file.txt	<i>/dir/file.txt</i>	<i>extractDir/dir/file.txt</i>

To sanitize absolute paths

- In the `KVExtractSubFileArg` struct that you pass in to `fpExtractSubFile`, set the flag `KVExtractionFlag_SanitizeAbsolutePaths`. When KeyView sanitizes a path and the resulting

directory does not exist, extraction fails unless you instruct KeyView to create the directory, so you might also want to set the flag `KVExtractionFlag_CreateDir`. You can find the path that a file was actually extracted to from the [KVSubFileExtractInfo](#) structure.

To sanitize absolute paths (through configuration)

- In the `formats_e.ini` configuration file, set the parameter `SanitizeAbsoluteExtractPaths`, for example:

```
[Options]
SanitizeAbsoluteExtractPaths=TRUE
```

Extract Images

You can use the File Extraction API to extract images within the file by specifying the following in the `formats.ini` file:

```
[Options]
ExtractImages=TRUE
```

If you set this option, images within the file behave in the same way as any other subfile. Extracted images have the name `image[X].[Y]`, where `[X]` is an integer, and `[Y]` is the extension. The format of the image is the same as the format in which it is stored in the document.

This option can also be enabled by passing `KVFLT_EXTRACTIMAGES` to the `fpFilterConfig` function.

NOTE: Turning on `ExtractImages` can reduce the speed of the filtering operation.

Recreate a File's Hierarchy

When you extract a container file, any relationships between the subfiles in the container are not maintained. However, the File Extraction interface provides information that enables you to recreate the hierarchy. You can use the hierarchy to create a directory structure in a file system, or to categorize documents according to their relationship to each other. For example, if you use KeyView to generate text for a search engine, the hierarchical information enables your users to search for a document based on the document's parent or sibling. In addition, when the document is returned to the user, the parent and sibling documents can be returned as recommendations.

The information needed to recreate a file's hierarchy is provided in the call to [fpGetSubFileInfo\(\)](#). The members `KVSubFileInfo->parentIndex` and `KVSubFileInfo->childArray` provide information about a subfile's parent and children. Because you can only retrieve the first-level children in the subfile, you must call `fpGetSubFileInfo()` repeatedly until information for the leaf-node children is extracted.

Create a Root Node

Because of their structure, some container files do not contain a subfile or folder which acts as a root directory on which the hierarchy can be based. For example, subfiles in a Zip archive can be extracted, but none of the subfiles represent the root of the hierarchy. In this case, you must create an artificial *root node* at the top of the file hierarchy as a point of reference for each child, and ultimately to recreate the relationships. This artificial root node is an internal object, and is extracted to disk as a directory called *root*. Its index number is 0.

To create the root node, set `openFlag` to `KVOpenFileFlag_CreateRootNode` in the call to `fpOpenFile()`. When you create a root node, the value of `numSubFiles` in `KVMainFileInfo` includes the root node. For example, when you call `fpGetMainFileInfo()` on a Microsoft Word document with three embedded OLE objects and the root node is disabled, `numSubFiles` is 3. If you create a root node, `numSubFiles` is 4.

Recreate a File's Hierarchy—Example

For example, you might extract a PST file that contains seven subfiles with a root node enabled. The call to `fpGetMainFileInfo()` returns the number of subfiles as eight (seven subfiles and one root node). The following diagram shows the structure and the available hierarchy information after the subfiles are extracted:

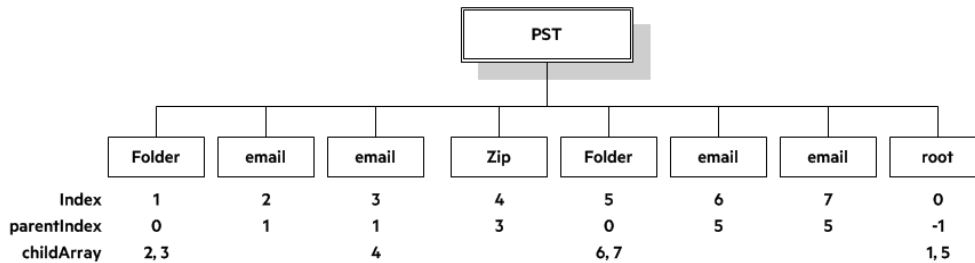

The `parentIndex` specifies the index number of a subfile's parent. The `childArray` specifies an array of a subfile's children. With this information, you can recreate the hierarchy shown in the following diagram.

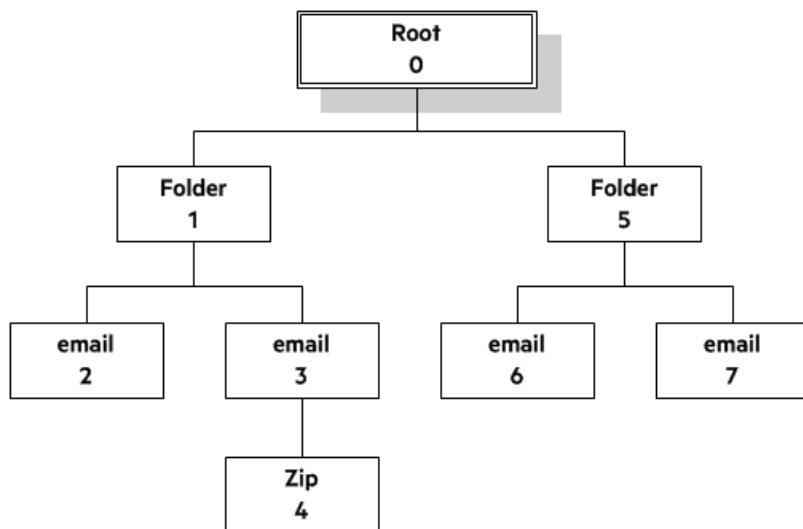

Extract Mail Metadata

You can extract metadata, such as subject, sender, and recipient, from subfiles of mail formats, by calling the [fpGetSubFileMetaData\(\)](#) function. You can extract a predefined set of common metadata fields, a list of metadata fields by their names or MAPI properties, or, for some subfile types, all the metadata in the file.

Default Metadata Set

KeyView internally defines a set of common mail metadata fields that you can extract as a group from mail formats. This default metadata set is listed in the following table.

Default Mail Metadata List

Field Name (string to specify)	Description
From	The display name and email address of the sender.
Sent	The time that the message was sent.
To	The display names and email addresses of the recipients.
Cc	The display names and email addresses of recipients who receive copies of the email.
Bcc	The display names and email addresses of recipients who received blind copies of the email.
Subject	The text in the subject line of the message.
Priority	The priority applied to the message.

Because mail formats use different terms for the same fields, the format's reader maps the default field name to the appropriate format-specific name. For example, when retrieving the default metadata set, the NSF field *Importance* is mapped to the name *Priority* and is returned.

You can also extract the default field names individually by passing the field name (such as *From*, *To*, and *Subject*); however, in this case, the string is not mapped to the format-specific name. For example, if you pass *Priority* in the call, you retrieve the contents of the *Priority* field from an MBX file, but do not retrieve the contents of the *Importance* field from an NSF file.

NOTE: You cannot pass the field names listed in the table individually for PST files. However, you can pass either the MAPI tag number or the MAPI tag name as integers. See [Microsoft Personal Folders File \(PST\) Metadata, on page 65](#).

Extract the Default Metadata Set

To extract the default metadata set, call the [fpGetSubFileMetaData\(\)](#) function, and pass in 0 for `metaArg->metaNameCount`, and NULL for `metaArg->metaNameArray`.

```
KVGetSubFileMetaArgRec metaArg;
KVSubFileMetaData pMetaData = NULL;
KVStructInit(&metaArg);

metaArg.index = subFileIndex;
metaArg.metaNameCount = 0;
metaArg.metaNameArray = NULL;

error = extractInterface->fpGetSubFileMetaData(pFile, &metaArg, &pMetaData);
...
extractInterface->fpFreeStruct(pFile, pMetaData);
pMetaData = NULL;
```

Extract All Metadata

KeyView can extract all metadata from EML, MBX, MIME, NSF, ICS, and DXL subfiles. You can extract all metadata in a similar way to extracting the default metadata set, but when you call the [fpGetSubFileMetaData\(\)](#) function, pass in -1 for `metaArg->metaNameCount` and NULL for `metaArg->metaNameArray`.

Microsoft Outlook (MSG) Metadata

In addition to the default metadata set, you can extract the metadata fields listed in the following table for MSG files. You must pass the field name to `metaNameArray` in the call to the `fpGetSubFileMetadata()` function.

MSG-specific Metadata List

Field Name (string to specify)	Description
AttachFileName	An attachment's long file name and extension, excluding the path.
ConversationTopic	The topic of the first message in a conversation thread. A conversation thread is a series of messages and replies. This is the first message's subject with any prefix removed.
CreationTime	The time that the message or attachment was created. This value is displayed in the Sent field in the message's Properties dialog in Outlook.
InternetMessageID	The identifier for messages that come in over the Internet. This is the MAPI property PR_INTERNET_MESSAGE_ID. This property is not in the MAPI headers or MAPI documentation.
LastModificationTime	The time that the message or attachment was last modified. This value is displayed in the Modified field in the message's Properties dialog in Outlook.
Location	The physical location of the event specified in the Outlook calendar entry.
MessageID	The message transfer system (MTS) identifier for the message transfer agent (MTA). This value is displayed on the Message ID tab in the message's Properties dialog in Outlook.
Received	The date and time a message was delivered. This value is displayed in the Received field in the message's Properties dialog in Outlook.
Sender	The name and email address of the message sender. This value is a concatenation of two MAPI properties in the following format: "PR_SENDER_NAME" <PR_SENDER_EMAIL_ADDRESS> The Sender value might be the same as or different than the default metadata From value (see Default Metadata Set, on page 60), depending on which MAPI properties exist in the MSG file.
Sensitivity	The value indicating the message sender's opinion of the sensitivity of a message. For example, Personal, Private, or Confidential. This value is displayed in the Sensitivity field in the message's Properties dialog in Outlook.
TransportMsgHeaders	Transport-specific message envelope information. This value corresponds to the MAPI property PR_TRANSPORT_MESSAGE_HEADERS.
StartDate	An appointment start date. This value corresponds to the PR_START_DATE MAPI property.
EndDate	An appointment end date. This value corresponds to the PR_END_DATE MAPI property.

Extract MSG-Specific Metadata

To extract specific metadata fields from an MSG file, call the [fpGetSubFileMetaData\(\)](#) function, and pass the field name defined in [Default Metadata Set, on page 60](#) to `metaNameArray` (the string is not case sensitive).

For example, the following code extracts the contents of the `ConversationTopic` and `MessageID` fields:

```
KVGetSubFileMetaArgRec metaArg;
KVSubFileMetaData pMetaData = NULL;
KVStructInit(&metaArg);
KVMetaNameRec names[2];
KVMetaName pname[2];

names[0].type = KVMetaNameType_String;
names[0].name.sname = "conversationtopic";
names[1].type = KVMetaNameType_String;
names[1].name.sname = "MessageID";

pname[0] = &names[0];
pname[1] = &names[1];

metaArg.metaNameCount = 2;
metaArg.metaNameArray = pname;
metaArg.index = subFileIndex;

error = extractInterface->fpGetSubFileMetaData(pFile, &metaArg, &pMetaData);
...
extractInterface->fpFreeStruct(pFile, pMetaData);
pMetaData = NULL;
```

Microsoft Outlook Express (EML) and Mailbox (MBX)

Metadata

In addition to the default metadata set, you can extract any metadata field that exists in the header of an EML or MBX file by passing the field's name. If the name is a valid field in the file, the content of the field is returned. For example, to retrieve the name of the last mail server that received the message before it was delivered, you can pass the string "Received".

Extract EML- or MBX-Specific Metadata

To extract specific metadata fields from an EML or MBX file, call the [fpGetSubFileMetaData\(\)](#) function, and pass the metadata name to `metaNameArray` (the string is *not* case sensitive).

For example, the following code extracts the contents of the `Received` and `Mime-version` fields:

```
KVGetSubFileMetaArgRec metaArg;
KVSubFileMetaData pMetaData = NULL;
```

```
KVStructInit(&metaArg);
KVMetaNameRec names[2];
KVMetaName pname[2];

names[0].type = KVMetaNameType_String;
names[0].name.sname = "Received";
names[1].type = KVMetaNameType_String;
names[1].name.sname = "Mime-version";

pname[0] = &names[0];
pname[1] = &names[1];

metaArg.metaNameCount = 2;
metaArg.metaNameArray = pname;
metaArg.index = subFileIndex;
error = extractInterface->fpGetSubFileMetaData(pFile, &metaArg, &pMetaData);
...
extractInterface->fpFreeStruct(pFile, pMetaData);
pMetaData = NULL;
```

Lotus Notes Database (NSF) Metadata

In addition to the default metadata set, you can extract any Lotus field name that exists in an NSF file by passing the field's name. (You can extract fields from mail NSF files and non-mail NSF files.) If the name is a valid field in the file, the field is returned. For example, to retrieve the date when a document in an NSF file was last accessed, you would pass the string "\$LastAccessedDB".

NOTE: A complete list of NSF fields is provided in the Lotus Notes file `stdnames.h`. This header file is available in the Lotus API Toolkit.

Extract NSF-Specific Metadata

To extract specific metadata fields from an NSF file, call the `fpGetSubFileMetaData()` function, and pass the metadata name to `metaNameArray` (the string is *not* case sensitive).

For example, the following code extracts the contents of the Description and Categories fields:

```
KVGetSubFileMetaArgRec metaArg;
KVSubFileMetaData pMetaData = NULL;
KVStructInit(&metaArg);
KVMetaNameRec names[2];
KVMetaName pname[2];

names[0].type = KVMetaNameType_String;
names[0].name.sname = "description";
names[1].type = KVMetaNameType_String;
names[1].name.sname = "Categories";

pname[0] = &names[0];
```



```
pname[1] = &names[1];

metaArg.metaNameCount = 2;
metaArg.metaNameArray = pname;
metaArg.index = subFileIndex;

error = extractInterface->fpGetSubFileMetaData(pFile, &metaArg, &pMetaData);
...
extractInterface->fpFreeStruct(pFile, pMetaData);
pMetaData = NULL;
```

Microsoft Personal Folders File (PST) Metadata

In addition to the default metadata set, you can extract Messaging Application Programming Interface (MAPI) properties from a PST file. These properties describe all elements of an Outlook item in a PST file (such as subject, sender, recipient, and message text). Because the properties are stored in the PST file itself, you can retrieve them *before* you extract the contents of the PST. This enables you to determine whether an Outlook item should be extracted based on its attributes. Some MAPI properties are also stored for Outlook attachments that are *not* mail messages (such as an attached Microsoft Word document or Lotus 1-2-3 file).

NOTE: Because all elements of a message (except non-mail attachments) are represented by MAPI properties, you can extract all components of a subfile, including the header and message text, by calling the `fpGetSubFileMetadata()` function.

MAPI Properties

Each MAPI property is identified by a property tag, which is a constant that contains the property type and a unique identifier. For example, the property that indicates whether a message has attachments has the following components:

Property	PR_HASATTACH
Identifier	0x0E1B
Property type	PT_BOOLEAN (000B)
Property tag	0x0E1B000B

The Microsoft MAPI documentation on the Microsoft Developer Network website lists all available MAPI properties, their tags, and types.

You can retrieve any MAPI property that is of one of the MAPI property types listed below:

PT_I2	PT_DOUBLE	PT_STRING8
PT_I4	PT_FLOAT	PT_TSTRING
PT_BINARY	PT_LONG	PT_SYSTIME
PT_BOOLEAN	PT_SHORT	PT_UNICODE

NOTE: Properties with a PT_TSTRING type have the property type recompiled to either a Unicode string (PT_UNICODE) or to an ANSI string (PT_STRING8) depending on the operating system's character set. To retrieve the Unicode property, pass in the Unicode version of the tag. For example, the property tag for PR_SUBJECT is either 0x0037001E for an ANSI string, or 0x0037001F for a Unicode string.

Extract PST-Specific Metadata

In the call to extract subfile metadata, you can pass either the MAPI tag number (such as 0x0070001e) or the MAPI tag name (such as PR_CONVERSATION_TOPIC). If you specify the MAPI tag name, you must include the mapitags.h and mapidefs.h Windows header files, in which the MAPI tag name is defined as a tag number.

To extract specific MAPI properties from a PST file, call the [fpGetSubFileMetaData\(\)](#) function, and pass the property tag to metaNameArray. The tag is passed as an integer.

For example, the following code extracts the MAPI properties PR_SUBJECT and PR_ALTERNATE_RECIPIENT:

```
KVGetSubFileMetaArgRec metaArg;
KVSubFileMetaData pMetaData = NULL;
KVMetaNameRec names[2];
KVMetaName pName[2];

names[0].type = KVMetaNameType_Integer;
names[0].name.iname = PR_SUBJECT;

names[1].type = KVMetaNameType_Integer;
names[1].name.iname = 0x3A010102;

pName[0] = &names[0];
pName[1] = &names[1];

KVStructInit(&metaArg);

metaArg.metaNameCount = 2;
metaArg.metaNameArray = pName;
metaArg.index = SubFileIndex;

error = extractInterface->fpGetSubFileMetaData (pFile,&metaArg,&pMetaData);
...
extractInterface->fpFreeStruct(pFile,pMetaData);

pMetaData = NULL;
```

NOTE: You must include the mapitags.h and mapidefs.h Windows header files, in which PR_SUBJECT is defined as 0x0037001E.

Exclude Metadata from the Extracted Text File

When you extract a mail message, the message text and header information (To, From, Sent, and so on) is also extracted. You can prevent the header information from appearing in the text file.

To exclude the header information, set `extractFlag` to `KVExtractionFlag_ExcludeMailHeader` in the call to `fpExtractSubFile()`.

Extract Subfiles from Outlook Files

When you extract an Outlook file (MSG) to disk, the message text and header information (To, From, Sent, and so on) is extracted to a text file. (If you do not want the header information to appear in the text file, see [Exclude Metadata from the Extracted Text File, above](#).) If the Outlook file contains a non-mail attachment, the attachment is extracted in its native format to a subdirectory. If the Outlook file contains a mail attachment, the attachment's message text is extracted to a subdirectory.

Extract Subfiles from Outlook Express Files

When you extract an Outlook Express (EML) file to disk, the message text and header information (To, From, Sent, and so on) is extracted to a text file. (If you do not want the header information to appear in the text file, see [Exclude Metadata from the Extracted Text File, above](#).) If the Outlook file contains a non-mail attachment, the attachment is extracted in its native format to the same directory as the message text file. If the Outlook file contains a mail attachment, the complete attachment (including message text and attachments), the message text file, and any non-mail attachments are extracted to the same directory as the main message.

NOTE: When the MBX reader (`mbxsr`) is enabled, it is used to filter MBX *and* EML files. If the MBX reader is not enabled, the EML reader (`emlsr`) is used.

Extract Subfiles from Mailbox Files

A Mailbox (MBX) file is a collection of individual emails compiled with RFC 822 and RFC 2045 - 2049 (MIME), and divided by message separators. There are many mail applications that export to an MBX format, such as Eudora Email and Mozilla Thunderbird.

When an MBX file is extracted to disk, the message text and header information (To, From, Sent, and so on) from each mail file is extracted to text files. (If you do not want the header information to appear in the text file, see [Exclude Metadata from the Extracted Text File, above](#).)

In Eudora MBX files, attachments are inserted as a link and are stored externally from the message. These attachments are not extracted, but the path to the attachment is returned in the call to the `fpGetSubFileInfo()` function. You can write code to retrieve the attachment based on the returned path.

For MBX files from other clients, KeyView extracts attachments when they are embedded in the message.

The Mailbox (MBX) reader is an advanced feature and is sold and licensed separately. To enable this reader in a KeyView SDK, you must obtain the appropriate license key from Micro Focus. See [Pass License Information to KeyView, on page 21](#) for information on adding a new license key to an existing installation.

Extract Subfiles from Outlook Personal Folders Files

KeyView can extract Outlook items such as messages, appointments, contacts, tasks, notes, and journal entries from a PST file. When a PST file is extracted to disk, the text and header information (To, From, Sent, and so on) from each Outlook item is extracted to a text file. (If you do not want the header information to appear in the text file, see [Exclude Metadata from the Extracted Text File, on the previous page.](#))

You can also extract messages from PST files as MSG files, including all their attachments, by setting the `KVExtractionFlag_SaveAsMSG` flag in the `KVExtractSubFileArg` structure when you call `fpExtractSubFile()`.

If an Outlook item contains a non-mail attachment, the attachment is extracted in its native format to a subdirectory. If an Outlook item contains an Outlook attachment, the attached item's text and any attachments are extracted to a subdirectory.

NOTE: The Microsoft Outlook Personal Folders (PST) readers are an advanced feature and are sold and licensed separately. To enable these readers in a KeyView SDK, you must obtain an appropriate license key from Micro Focus. For information about adding a new license key to an existing installation, see [Pass License Information to KeyView, on page 21](#).

Choose the Reader to use for PST Files

KeyView provides several ways of processing PST files:

- Indirectly, using the Microsoft Messaging Application Programming Interface (MAPI). MAPI is a Microsoft interface that enables different applications to exchange messages and attachments with each other. MAPI allows KeyView to open a PST file, traverse the folders, and extract items. The `psts_r` reader uses MAPI, but works only on Windows and requires that Microsoft Outlook is installed.
- Directly, without relying on the Microsoft interface to the PST format. Accessing the file directly does not require Microsoft Outlook. The `pstxs_r` reader is available for Windows (32-bit and 64-bit) and Linux (64-bit only). The `pstns_r` reader is an alternative native reader, for the platforms not supported by `pstxs_r`.

On Windows, the MAPI-based reader is used by default but you can choose `pstxs_r` if you prefer. On UNIX platforms, only one of the native readers is available (`pstxs_r` on Linux x64 and `pstns_r` on other platforms).

The differences between the readers are summarized in the following table.

Feature	Native Reader (pstxsr)	Native Reader (pstnsr)	MAPI-based Reader (pstsrr)
Platforms supported	Windows x86 and x64 Linux x64	All platforms not supported by pstxsr	Windows x86 and x64
Outlook required	No	No	Yes
MAPI properties supported	Yes. All properties defined in <code>mapitags.h</code> . Object properties are not supported.		
Password protection supported	Yes	Yes	Yes (using <code>KVCredential</code> structure)
Compressible encryption supported	Yes	Yes	Yes
High encryption supported	No	No	Yes

To change the reader used to process PST files, change the PST entry (file category value 297) in the `formats_e.ini` file. For example, to use `pstxsr`:

```
297=pstx
```

NOTE: You must make sure that the PST that you are extracting is not open in the Outlook client, and that the Outlook process is not running.

NOTE: When extracting subfiles from PST files, information on the distribution list used in an email is extracted to a file called `emailname.dist`. This applies to the MAPI reader (`pstsrr`) only.

System Requirements

MAPI is supported on Windows platforms only and relies on functionality in Outlook. If you want to use the MAPI-based reader, `pstsrr`, Microsoft Outlook must be installed on the same machine as your application. Outlook must also be the default email application. KeyView supports the following PST formats and Outlook clients:

- Outlook 97 or later PST files

NOTE: The Outlook client must be the same version as, or newer than, the version of Outlook that generated the PST file.

- Outlook 2002 or later clients

NOTE: You must install an edition of Microsoft Outlook (32-bit or 64-bit) that matches the KeyView software. For example, if you use 32-bit KeyView, install 32-bit Outlook. If you use 64-bit KeyView, install 64-bit Outlook.

If the editions do not match, KeyView returns Error 32: `KVError_PSTAccessFailed` and an error message from Microsoft Office Outlook is displayed: Either there is a no default mail client or the current mail client cannot fulfill the messaging request. Please run Microsoft Outlook and set it as the default mail client.

MAPI Attachment Methods

The way in which you can access the contents of a PST message attachment is determined by the MAPI *attachment method* applied to the attachment. For example, if the attachment is an embedded OLE object, it uses the `ATTACH_OLE` attachment method. KeyView can access message attachments that use the following attachment methods:

`ATTACH_BY_VALUE`

`ATTACH_EMBEDDED_MSG`

`ATTACH_OLE`

`ATTACH_BY_REFERENCE`

`ATTACH_BY_REF_ONLY`

`ATTACH_BY_REF_RESOLVE`

Attachments using the `ATTACH_BY_VALUE`, `ATTACH_EMBEDDED_MSG`, or `ATTACH_OLE` attachment methods are extracted automatically when the PST file is extracted. An "attach by reference" method means that the attachment is not in Outlook, but Outlook contains an absolute path to the attachment. Before you can extract these types of attachments, you must retrieve the path to access the attachment.

To extract "attach by reference" attachments

1. Determine whether the attachment uses an `ATTACH_BY_REFERENCE`, `ATTACH_BY_REF_ONLY`, or `ATTACH_BY_REF_RESOLVE` method by retrieving the MAPI property `PR_ATTACH_METHOD`.
2. If the attachment uses one of the "attach by reference" methods, get the fully qualified path to the attachment by retrieving the MAPI properties `PR_ATTACH_LONG_PATHNAME` or `PR_ATTACH_PATHNAME`.
3. You can then either copy the files from their original location to the path where the PST file is extracted, or use the Export API functions to convert the attachment.

Open Secured PST Files

KeyView enables you to specify a user name and password to use to open a secured PST file for extraction.

To open password-protected PST files that use high encryption, you must use the MAPI-based PST reader (`pstsr`). The native PST readers (`pstxsr` and `pstnsr`) return the error message `KVERR_PasswordProtected` if a PST file is encrypted with high encryption.

Detect PST Files While the Outlook Client is Running

If you are running an Outlook client while running the File Extraction API, the KeyView format detection module (kwad) might not be able to open the PST file to determine the file's format because Outlook has the file locked. In this case, you can do one of the following:

- Close Outlook when using the Extraction API.
- Detect PST files by extension only and bypass the format detection module. To enable this option, add the following lines to the `formats_e.ini` file:

```
[container_flags]
detectPSTbyExtension=1
```

The `detectPSTbyExtension` option applies only when you are using the MAPI reader (`psts_r`).

If you use this option, you must make sure in your code that valid PST files are passed to KeyView, because the format detection module is not available to verify the file type and pass the file to the appropriate reader.

Extract Subfiles from Lotus Domino XML Language Files

When you extract a Lotus Domino XML Language (.DXL) file, the message text and header information (*To*, *From*, *Sent*, and so on) is extracted to a text file.

NOTE: To prevent header information from being extracted, see [Exclude Metadata from the Extracted Text File, on page 67](#).

You can make sure that dates and times extracted from Lotus Domino .DXL files are displayed in a uniform format.

To extract custom date/time formats

- In the `formats_e.ini` file, set the `DateTimeFormat` option in the `[dxl_r]` section. For example:

```
[dxl_r]
DateTimeFormat=%m/%d/%Y %I:%M:%S %p
```

In this example, dates and times are extracted in the following format:

02/11/2003 11:36:09 AM

The format arguments are the same as those for the `strftime()` function. See <http://msdn.microsoft.com/en-us/library/fe06s4ak%28VS.71%29.aspx> for more information.

Extract .DXL Files to HTML

You can use the file extraction API to process .DXL files with an XSLT engine. The XSLT engine then transforms the extracted .DXL to .mail HTML files.

To extract .DXL files to HTML

- Set the following options in the `formats_e.ini` file:

```
[nsfsr]
ExportDXL=1
ExportDXL_PureXML=1

[dxlsr]
LNDParser=2
```

Extract Subfiles from Lotus Notes Database Files

A Lotus Notes database is a single file that contains multiple documents called *notes*. Notes include design notes (such as forms, views, folders, navigators, outlines, pages, framesets, agents, and resources), data document notes, profile document notes, access control list notes, and collection (index) notes. KeyView can extract text items, attachments, and OLE objects from *data document notes* only. Data document notes include emails, journal entries, discussion threads, documents (Microsoft Office and Lotus SmartSuite), and so on.

All components of a note are prefixed by field names such as "SendTo:", "Subject:", and "Body:". When a note is extracted, the field names are not included in the extracted output; only the field values are extracted.

When a mail message in an NSF file is extracted to disk, the body text and header information (such as the values from the SendTo, From, and DeliveredDate fields) in each message is extracted to a text file. (If you do not want the header information to appear in the message text file, see [Exclude Metadata from the Extracted Text File, on page 67.](#))

NOTE: The Lotus Notes Database (NSF) reader is an advanced feature and is sold and licensed separately. To enable this reader in a KeyView SDK, you must obtain the appropriate license key from Micro Focus. See [Pass License Information to KeyView, on page 21](#) for information on adding a new license key to an existing installation.

System Requirements

The NSF format is proprietary. Therefore, KeyView accesses NSF files indirectly by using the Lotus Notes API. Because the NSF reader relies on functionality in Lotus Notes, a Lotus Notes client or

Lotus Domino server must be installed and configured on the same machine as the application converting NSF files. On UNIX and Linux, the Lotus Domino server is required. On Windows, the Lotus Notes client or Lotus Domino server is required.

KeyView supports the following Lotus Notes clients and Domino servers:

- Lotus Notes 6.5.1
- Lotus Domino 6.5.1

KeyView supports NSF files on the same platforms supported by Lotus Notes and Lotus Domino:

- Windows XP x86 (Service Pack 1 and 2)
- Windows 2000 x86 (Service Pack 2)
- Solaris 8.0 and 9.0 (built on Solaris 8.0)
- Red Hat Enterprise Linux AS 3.0 (x86)
- SuSE Linux Enterprise Server 8 and 9 (x86)
- IBM AIX 5.1, 5L version 5.2

Installation and Configuration

Before KeyView can convert NSF files, you must set up the Lotus Notes client or Lotus Domino server. Full configuration is not required. The following steps outline the minimal setup for NSF conversion:

Windows

1. Install the Lotus Notes client or Lotus Domino server. You do not need to configure the client or server.
2. Make sure that the `notes.ini` file is in the proper location.
 - If Lotus Notes is installed, the file should appear in the `install\lotus\notes` directory, where `install` is the installation directory.
 - If only Lotus Domino is installed, the file should appear in the `install\lotus\domino` directory, where `install` is the installation directory.

If the file does not exist, create an ASCII file named `notes.ini`, and add the following text:

```
[Notes]
```

3. Add the KeyView `bin` directory and the `install\lotus\notes` or `install\lotus\domino` directory to the `PATH` environment variable (the KeyView `bin` directory must be first in the path). Micro Focus recommends that you add the KeyView `bin` directory because the Lotus Notes or Domino server installation might contain older KeyView OEM libraries.

Solaris

1. Install Lotus Domino server. You do not need to configure the server.
2. Make sure that the `notes.ini` file is in the `install/lotus/notes/latest/sunspa` directory,

where *install* is the directory where Lotus Notes is installed. If the file does not exist, create an ASCII file named *notes.ini*, and add the following text:

```
[Notes]
```

3. Add the *install/lotus/notes/latest/sunspa* directory to the PATH environment variable:

```
setenv PATH install/lotus/notes/latest/sunspa:$PATH
```

4. Add the *install/lotus/notes/latest/sunspa* and the KeyView bin directory to the LD_LIBRARY_PATH environment variable:

```
setenv LD_LIBRARY_PATH keyview_bin:install/lotus/notes/latest/sunspa:$LD_LIBRARY_PATH
```

where *keyview_bin* is the location of the KeyView bin directory. Micro Focus recommends that you add the KeyView bin directory because the Lotus Notes installation might contain older KeyView OEM libraries.

AIX 5.x

1. Install the *bos.iocp.rte* file set if it is not already installed, and reboot the machine. See the Lotus Domino server documentation for more information.
2. Install Lotus Domino server. You do not need to configure the server.
3. Make sure that the *notes.ini* file is in the *install/lotus/notes/latest/ibmpow* directory, where *install* is the directory where Lotus Notes is installed. If the file does not exist, create an ASCII file named *notes.ini*, and add the following text:

```
[Notes]
```

4. Add the *install/lotus/notes/latest/ibmpow* directory to the PATH environment variable:

```
setenv PATH install/lotus/notes/latest/ibmpow:$PATH
```

5. Add the *install/lotus/notes/latest/ibmpow* and the KeyView bin directory to the LIBPATH environment variable:

```
setenv LIBPATH keyview_bin:install/lotus/notes/latest/ibmpow:$LIBPATH
```

where *keyview_bin* is the location of the KeyView bin directory. Micro Focus recommends that you add the KeyView bin directory because the Lotus Notes installation might contain older KeyView OEM libraries.

Linux

1. Install Lotus Domino server. You do not need to configure the server.
2. Make sure that the *notes.ini* file is in the *install/lotus/notes/latest/linux* directory, where *install* is the directory where Lotus Notes is installed. If the file does not exist, create an ASCII file named *notes.ini*, and add the following text:

```
[Notes]
```

3. Add the *install/lotus/notes/latest/linux* directory to the PATH environment variable:

```
setenv PATH install/lotus/notes/latest/linux:$PATH
```

4. Add the *install/lotus/notes/latest/linux* and the KeyView bin directory to the LD_LIBRARY_PATH environment variable:

```
setenv LD_LIBRARY_PATH keyview_bin:install/lotus/notes/latest/linux:$LD_LIBRARY_PATH
```

where *keyview_bin* is the location of the KeyView bin directory. Micro Focus recommends that you add the KeyView bin directory because the Lotus Notes installation might contain older KeyView OEM libraries.

Open Secured NSF Files

KeyView enables you to specify a user ID file and password to use to open a secured NSF file for extraction.

Format Note Subfiles

The KeyView NSF reader uses XML templates to format note subfiles. You can customize the templates to approximate the look and feel of the original notes as closely as possible. For more information, see [Extract and Format Lotus Notes Subfiles, on page 438](#).

Extract Subfiles from PDF Files

KeyView can extract document-level and page-level attachments from a PDF document. Document-level attachments are added by using the **Attach A File** tool, and can include links to or from the parent document or to other file attachments. Page-level attachments are added as comments by using various tools. Page-level or comment attachments display the File Attachment icon or the Speaker icon on the page where they are located. KeyView can also extract the files from Portfolio PDFs.

When a PDF's attachments are extracted to disk, the attachments are saved in their native format.

Improve Performance for PDFs with Many Small Images

To improve performance when processing PDF files that contain many small images, you can choose to ignore images unless they exceed a minimum width and/or height. If an image is smaller than the minimum width or height, KeyView does not extract the image.

For example, to ignore images that are less than 16 pixels wide or less than 16 pixels in height, add the following to the [pdf_flags] section of the *formats_e.ini* file:

```
[pdf_flags]  
process_images_with_min_width=16  
process_images_with_min_height=16
```

Extract Embedded OLE Objects

Embedded OLE objects can be converted in two ways:

- Using the File Extraction API, the OLE object is first extracted from the main file and saved to disk. It can then be converted by making a separate conversion call.
- Using the HTML Export API, the main file is converted to HTML and the OLE object is converted to a graphics file that is referenced in the HTML file .

The File Extraction API can extract embedded OLE objects from the following types of documents:

- Lotus Notes (DXL)
- Microsoft Excel
- Microsoft Word
- Microsoft PowerPoint
- Microsoft Outlook
- Microsoft Visio
- Microsoft Project
- OASIS Open Document
- Rich Text Format (RTF)

When an embedded OLE object is extracted from its parent file, the location of the embedded file in the original document is not available. The parent and child are extracted as separate files.

Extract Subfiles from ZIP Files

You can extract ZIP files that are not password-protected by using the general method (see [Extract Subfiles, on page 56](#)). However, some ZIP files use password protection, in which case you must use a different method to enter the required credentials.

Default File Names for Extracted Subfiles

When you do not specify a file name in the call to [fpExtractSubFile\(\)](#), in some cases a default file name is applied to the extracted subfile.

Default File Name for Mail Formats

To avoid naming conflicts and problems with long file names, KeyView applies its own names to the extracted mail items when you do not supply a name in the call to `fpExtractSubFile()`. A non-mail attachment retains its original file name and extension.

When the contents of a mail store or the message body of a mail message are extracted, the extracted file names can include the following:

- The first valid eight characters of the original folder name or "Subject" line of the mail message. If the "Subject" line is empty, the characters `kvext` are used, where `ext` is the format's extension. For example, the characters would be `"kvmsg"` for MSG and `"kvnsf"` for NSF.

For notes, the file name is derived from the first 24 characters of the note text. For contact entries, the file name is derived from the full name of the contact.

The following special characters are considered invalid and are ignored:

any non-printing character with a value less than `0x1F`

angle brackets (`<` `>`) double quotation marks (`"`)

asterisk (`*`) forward slash (`/`)

back slash (`\`) pipe (`|`)

colon (`:`) question mark (`?`)

- The characters `_kvn`, where `n` is an integer incremented from 0 for each extracted item.
- One of the following extensions:

Type	File Extension
email message	<code>.mail</code>
calendar appointment	<code>.cal</code>
contact entry	<code>.cont</code>
task entry	<code>.task</code>
note	<code>.note</code>
journal entry	<code>.jrn1</code>
distribution list	<code>.dist</code>
posting note	<code>.post</code>

- If the type cannot be determined for an MSG or PST file, the file is given a `.mail` extension.
- If the type cannot be determined for a NSF file, the file is given a `.tmp` extension.
- The format of a MAIL file is plain text by default, but can be set to RTF with the `KVExtractionFlag_GetFormattedBody` flag.

For example, an MSG mail message with the subject line *RE: Product roadmap* that contains the Microsoft Excel attachment `release_schedule.xls` is extracted as:

```
RE produ_kv0.mail  
release_schedule.xls
```

If an extracted message contains an embedded OLE object or any attachment that does not have a name, the object or attachment is extracted as `_kv#.tmp`.

Default File Name for Embedded OLE Objects

KeyView can apply a default name to an extracted embedded OLE object when you do not supply a name in the call to `fpExtractSubFile()`. When an embedded OLE object is extracted, the extracted file name can include the following:

- The characters `subfile_kvn`, where *n* is an integer incremented from 0 for each extracted object.
- If KeyView can determine the embedded OLE is a Microsoft Office document, the original extension is used. If the file type cannot be determined, the file is given a `.tmp` extension.

For example, a Microsoft Word document (`sales_quarterly.doc`) might contain two embedded OLE objects: a Microsoft Excel file called `west_region.xls`, and a bitmap created in the Word document. The embedded objects are extracted as `subfile_kv0.xls` and `subfile_kv1.tmp`.

Chapter 4: Use the HTML Export API

This section describes how to perform some basic tasks by using the HTML Export API.

• Extract Metadata	79
• Extract File Format Information	82
• Convert Character Sets	83
• Map Styles	87
• Use Style Sheets	90
• Display Vector Graphics on UNIX and Linux	91
• Search and Highlight Terms	91
• Include Revision Information	92
• Extract Text from Text Boxes	95
• Convert PDF Files	95
• Convert Spreadsheet Files	106
• Convert Presentation Files	110
• Convert XML Files	111
• Show Hidden Data	116
• Exclude Japanese Guide Text	118
• Source Code Identification	118
• Partitioning	119
• Configure the Proxy for RMS	120

Extract Metadata

When a file format supports metadata, KeyView can extract and process that information. Metadata includes document information fields such as title, author, creation date, and file size. Depending on the file's format, metadata is referred to in a number of ways: for example, "summary information," "OLE summary information," "file information," and "document properties."

The metadata in mail formats (MSG and EML) and mail stores (PST, NSF, and MBX) is extracted differently than other formats. For information on extracting metadata from these formats, see [Extract Mail Metadata, on page 60](#).

NOTE: KeyView can extract metadata from a document only if metadata is defined in the document, and if the document reader can extract metadata for the file format. The section [Document Readers, on page 392](#) lists the file formats for which metadata can be extracted. KeyView does not generate metadata automatically from the document contents.

Extract Metadata by Using the API

You can extract the metadata at the API level. The API extracts all valid metadata fields that exist in the file.

Use the C API

To extract metadata by using the C API

1. Declare a pointer to the `KVSummaryInfoEx` structure. [KVSummaryInfoEx](#), on page 226.
2. Call the `fpGetSummaryInfo()` function. See [fpGetSummaryInfo\(\)](#), on page 182.

Use the COM interface

To extract metadata by using the COM interface, call the `GetSummaryInfo()` method. See [GetSummaryInfo](#), on page 281.

Extract Metadata by Using a Template File

When using a template file, KeyView recognizes two types of metadata: *standard* and *non-standard*. Standard metadata includes fields, such as Title, Author, and Subject. The standard fields are enumerated from 1 to 41 in `KVSumType` in the header file `kvtypes.h`. Non-standard metadata includes any field not listed from 1 to 41 in `KVSumType`, such as user-defined fields (for example, custom property fields in Microsoft Word documents), or fields that are unique to a particular file type (for example, "Artist" or "Genre" fields in MP3 files). Enumerated types 42 and greater are reserved for non-standard metadata.

To extract metadata by using a template file

1. Insert metadata tokens in a member of the `KVHTMLTemplateEx` structure in the template file. This defines the point at which the metadata appears in the HTML output.
2. If you are using the `$USERSUMMARY` or `$SUMMARY` token, define the `szUserSummary` member of the `KVHTMLTemplateEx` structure in the template file. This determines the markup and tokens generated when these metadata tokens are processed.
3. In your application, read the template file and write the data to the `KVHTMLTemplateEx` structure.
See [htmlini](#), on page 129.

The following metadata tokens can be used in the template files:

Token	Description
<code>\$SUMMARYNN</code>	Inserts the data from a <i>specified</i> metadata field. <i>NN</i> is a number from 00 through 42 enumerated in <code>KVSumType</code> in <code>kvtypes.h</code> .

Token	Description
\$SUMMARY	Inserts the data from valid metadata fields in the range of 0 to 33 using the markup provided in pszUserSummary.
\$USERSUMMARY	Inserts the data from every valid non-standard metadata field using the markup provided in pszUserSummary.
\$CONTENT	Inserts the content of the metadata field specified by the \$NAME token.
\$NAME	Inserts the name of a the metadata field, such as "Title," "Author," or "Subject."

Depending on the markup in szUserSummary, the extracted metadata might not appear in the browser when the HTML file is displayed, but might appear in the output file. Most of the KeyView-supplied template files extract standard metadata from a document, and include it in the output HTML. However, they do not display the metadata in a browser.

Examples

\$SUMMARYNN

The following markup displays the contents of the "Title" field at the top of the main HTML file:

```
szMainTop=<em><strong>$SUMMARY01</strong></em>
```

In KVSumType, 01 is the enumerated value for the "Title" metadata field.

\$SUMMARY

The following markup extracts all standard fields, and includes them in the first heading level 1 HTML block:

```
szFirstH1Start=$SUMMARY  
szUserSummary=<meta name="$NAME" content="$CONTENT" />
```

This example extracts the field name (\$NAME) and field content (\$CONTENT) for standard metadata from a document, and includes it at the beginning of the first Heading level 1 HTML block. However, it does not display the metadata in the browser. The HTML output might look like this:

```
<meta name="CodePage" content="1252" />  
<meta name="Title" content="My design document" />  
<meta name="Subject" content="design specifications" />  
<meta name="Author" content="John Doe" />  
<meta name="Keywords" content="" />  
<meta name="Comments" content="" />  
<meta name="Template" content="Normal.dot" />  
<meta name="LastAuthor" content="lchapman" />  
<meta name="RevNumber" content="6" />  
<meta name="EditTime" content="01/01/1601, 0:08" />  
<meta name="LastPrinted" content="14/01/2002, 14:06" />  
<meta name="Create_DTM" content="27/08/2003, 10:31" />  
<meta name="LastSave_DTM" content="29/08/2003, 14:07" />
```

```
<meta name="PageCount" content="1" />  
<meta name="WordCount" content="4062" />  
<meta name="CharCount" content="23159" />  
<meta name="AppName" content="Microsoft Word 9.0" />  
<meta name="Security" content="0" />  
<meta name="Category" content="software" />  
<meta name="LineCount" content="192" />  
<meta name="ParCount" content="46" />  
<meta name="ScaleCrop" content="FALSE" />  
<meta name="Manager" content="" />  
<meta name="Company" content="Autonomy" />
```

To display the metadata in a browser, use the following markup in `szUserSummary`:

```
<hr>name="$NAME" content="$CONTENT" <br>/>
```

\$USERSUMMARY

The following markup extracts non-standard fields, and includes them at the bottom of the main HTML file:

```
szMainBottom=$USERSUMMARY  
szUserSummary=<meta name="$NAME" content="$CONTENT" />
```

This example extracts the field name (`$NAME`) and field content (`$CONTENT`) for non-standard metadata from a document, and includes it at the bottom of the main HTML file. However, it does not display the metadata in the browser. The HTML output might look like this:

```
meta name="Telephone number" content="444-111-2222"  
meta name="Recorded date" content="07/03/2003, 23:00"  
meta name="Source" content="TRUE"  
meta name="my property" content="reserved"
```

To display the metadata in a browser, use the following markup in `szUserSummary`:

```
<hr>name="$NAME" content="$CONTENT" <br>/>
```

Extract File Format Information

Export can detect a file's format, and report the information to the API, which in turn reports the information to the developer's application. This feature enables you to apply customized conversion settings based on a file's format. See [File Format Detection, on page 454](#) for more information on format detection.

Use the C API

To extract file format information by using the C API

1. Declare a pointer to the `KVStreamInfo` data structure. [KVStreamInfo](#), on page 223.
2. Call the `fpGetStreamInfo()` function. [fpGetStreamInfo\(\)](#), on page 182.

Use the COM interface

To extract file format information by using the COM interface, call the `GetFileInfo()` method. See [GetFileInfo](#), on page 280.

Convert Character Sets

Export allows you to control the character set of both the input and the output text. This is accomplished by either

- setting the source and/or target character set in the API, or
- basing the input/output on the character set of the document (if the document character set is stored in the document and can be determined by the document reader).

The character sets are enumerated in `KVCharSet` in `kvcharset.h`.

Not all character sets can be used to specify the target character set. See [Code Character Sets](#), on page 432 for a list of character sets that can be used as a target character set.

Determine the Character Set of the Output Text

To determine the output character set of a converted document, Export considers the following:

- Whether the reader can extract the character set from the document. This depends on whether the file format can provide character set information and whether the document actually contains character set information.

The section [Document Readers](#), on page 392 indicates the file formats for which character set information can be extracted. If character set information cannot be determined for your document type, you must set the source, the target character set, or both, in the API.

- Whether a source character set is set in the API.

NOTE: To set the source character set, you must specify a character set *and* set the `bForceSrcCharSet` member of the `KVHTMLOptionsEx` structure to `TRUE`.

- Whether a target character set is set in the API.

NOTE: To set the target character set, you must specify a character set *and* set the `bForceOutputCharSet` member of the `KVHTMLOptionsEx` structure to `TRUE`.

Guidelines for Character Set Conversion

The following diagram shows how the output character set is determined when the document character set can be determined:

Document Character Set Can Be Determined

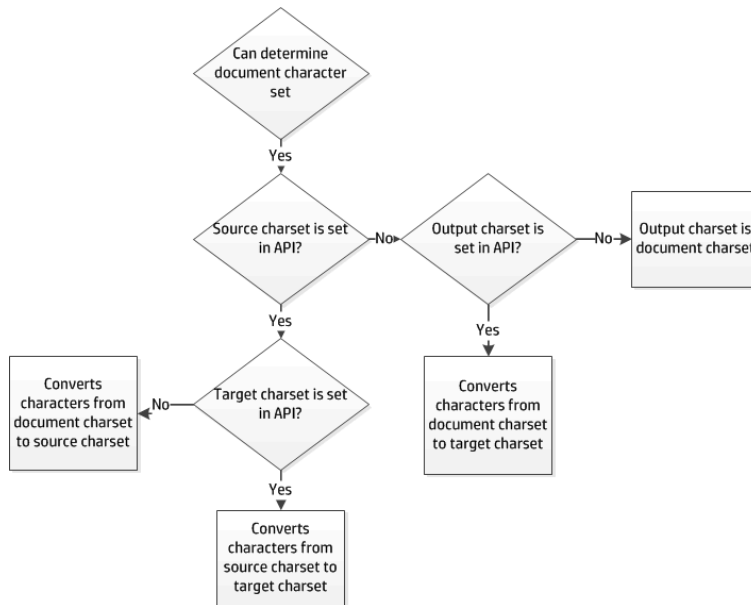

The following diagram shows how the output character set is determined when the document character set cannot be determined:

Document Character Set Cannot Be Determined

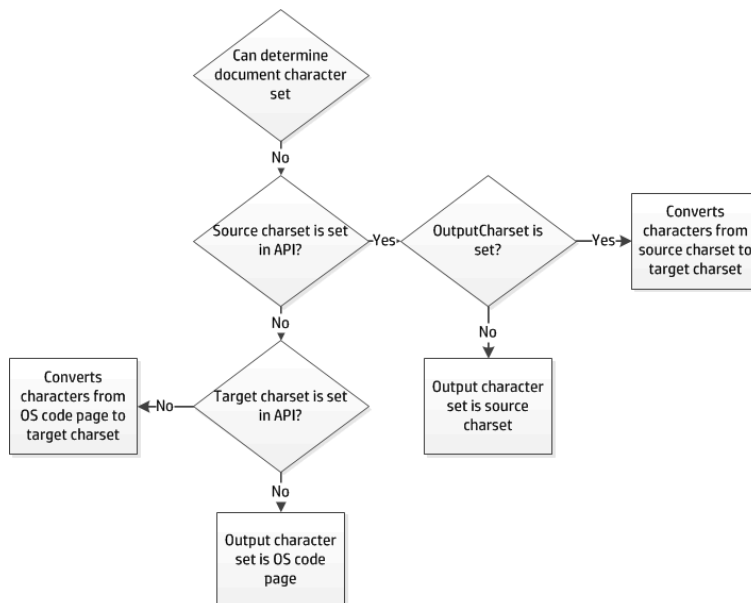

Examples of Character Set Conversion

The examples below demonstrate possible configurations for mapping character sets and the expected output for each scenario.

Document Character Set Can be Determined

For the example in the following table, the document is an RTF file. The section [Document Readers, on page 392](#) indicates that the document character set *can* be obtained from this file type. The document character set is Traditional Chinese (BIG5).

Document character set can be determined

Source charset set	Target charset set	Output charset
KVCS_GB	KVCS_UTF8	KVCS_UTF8 Converts GB (Simplified Chinese) to UTF-8. The output character set is the target character set specified in the API.
KVCS_GB	--	KVCS_GB Converts BIG5 to GB (Simplified Chinese). The output character set is the source character set specified in the API.
--	KVCS_UTF8	KVCS_UTF8 Converts BIG5 to UTF-8. The output character set is the target character set specified in the API.
--	--	KVCS_BIG5 The output character set is the document character set. No conversion.

Document Character Set Cannot be Determined

For the example in the following table, the document is an ASCII file. The section [Document Readers, on page 392](#) indicates that the document character set *cannot* be obtained from this file type. The document character set is KVCS_1251.

Document character set cannot be determined

Source charset set	Target charset set	Output charset
KVCS_1252	KVCS_UTF8	KVCS_UTF8 Converts KVCS_1252 to KVCS_UTF8. The output character set is the target

Document character set cannot be determined, continued

Source charset set	Target charset set	Output charset
		character set specified in the API.
KVCS_1252	KVCS_UNKNOWN	KVCS_1252 The output character set is the source character set specified in the API because KVCS_UNKNOWN cannot be used. No conversion.
KVCS_1252	--	KVCS_1252 The output character set is the source character set specified in the API. No conversion.
--	KVCS_1252	KVCS_1252 Converts OS code page to KVCS_1252. The output character set is the target character set specified in the API.
--	--	The output character set is OS code page. No conversion.

Set the Character Set During Conversion

You can convert the character set of a file at the time the file is converted.

To specify the source character set for documents from which the document character set cannot be obtained by the reader

1. Set the `eSrcCharSet` member of the `KVHTMLOptionsEx` structure to one of the character sets enumerated in `KVCharSet` in `kvcharset.h`. See [KVHTMLOptionsEx, on page 237](#).
2. Set the `bForceSrcCharSet` member of the `KVHTMLOptionsEx` structure to `TRUE`.

To specify the target character set

1. Set the `OutputCharSet` member of the `KVHTMLOptionsEx` structure to one of the character sets enumerated in `KVCharSet` in `kvcharset.h`. See [KVHTMLOptionsEx, on page 237](#).
2. Set the `bForceOutputCharSet` member of the `KVHTMLOptionsEx` structure to `TRUE`.

Set the Character Set During File Extraction from a Container

You can convert the character set of a container subfile at the time the subfile is extracted from the container and before it is converted to HTML. This is most often used to set the output character set of a mail message's body text. See [Use the HTML Export API, on page 79](#).

To specify the source character set of a subfile, call the `fpExtractSubFile()` function, and set the

KVExtractSubFileArg->srcCharset argument to any value in the enumerated list in KVCharSet in kvcharset.h. See [fpExtractSubFile\(\)](#), on page 142.

To specify the target character set of a subfile, call the fpExtractSubFile() function, and set the KVExtractSubFileArg->trgCharset argument to any value in the enumerated list in KVCharSet in kvcharset.h.

Map Styles

Export can map paragraph and character styles in any word processing format that contains styles (such as Microsoft Word, RTF, or Folio Flat File) to user-defined markup. This feature is useful for shaping the look of the HTML output, or for generating user-defined metadata (including using XML tags) for indexing, searching, and navigation. With this feature, you can redact (hide) text in the source document, delete content, or change the overall structure of the output. You can also embed style sheet styles in the output defined in the HTML.

To enable style mapping, you must indicate which paragraph and/or character styles are to be mapped, and define the starting and ending markup to be included in the HTML output.

For example, if the source Microsoft Word document contains the character style "Recipe," and the content of the style in Microsoft Word is "Brownies," you can specify that the starting markup be <recipe> and the ending markup </recipe>. This would result in the output HTML containing: <recipe>Brownies</recipe>.

You can also use style mapping to control the look of the HTML output either by using a Cascading Style Sheet (CSS) or by defining the style directly in the starting markup. For example, if a Word document contains the paragraph style "Colorful", you can have markup of the form <p><div class="rainbow"> inserted at the front of the paragraph and markup of the form </div></p> inserted at the end of the paragraph. "Rainbow" is a CSS style defined in an externally provided CSS file referenced at the top of the HTML output.

Style mapping is enabled in the wordstyle.ini template file. The *HTML Export Getting Started* page demonstrates the output resulting from a conversion with wordstyle.ini. The Getting Started page, named htmstart.html, is in the directory *install\htmlexport\docs*, where *install* is the path name of the Export installation directory. The source documents used in the page are in the directory *install\testdocs*.

NOTE: When the user-defined markup in KVStyle conflicts with other markup generated by Export, the user-defined markup takes precedence.

Use the C API

To map styles by using the C API

1. Define the KVStyle structure. See [KVStyle](#), on page 224. The information in this structure includes:

- the markup to be added to the beginning and end of a paragraph or character style.
 - the name of the word processing style (for example, "Heading 1") to which style mapping applies. Style names are case sensitive.
 - the flag which defines instructions on how to process the content associated with a paragraph or character style. The flags are defined in `kvtypes.h` and described in [Flags for Defining Styles, on the next page](#).
2. Call the `fpSetStyleMapping()` function. See [fpSetStyleMapping\(\), on page 188](#).

Use a Template file

To map styles by using a template file

1. Use the `KVStyle` parameter to specify how many styles are being mapped. For example, if there are nine mapped heading levels, add the following:

```
[KVStyle]
NumStyles=9
```

2. For each style, there must be a `[StyleX]` entry that contains the markup that appears at the start and end of the defined style. For example, in the `wordstyle.ini` sample file, the first heading level is defined as follows:

```
[Style1]
StyleName=Colorful
MarkupStart=<div class="colorful">
MarkupEnd=<!-- end of colorful --></div>
```

These values are used in `StyleName`, `MarkupStart`, and `MarkupEnd` in the `KVStyle` structure. See [KVStyle, on page 224](#).

3. For each style, define the flag that applies. Flags define instructions on how to process the content associated with a paragraph or character style.

They are defined in `kvtypes.h` and described in [Flags for Defining Styles, on the next page](#). This value is used in `dwFlags` of the `KVStyle` structure. See [KVStyle, on page 224](#). The value associated with each flag is a hexadecimal number. You can set an option by either entering the converted decimal value or entering the flag's text.

```
Flags=0
```

A finished entry in a template file could look like this:

```
[KVStyle]
NumStyles=3

[Style1]
StyleName=Colorful
MarkupStart=<div class="Colorful">
MarkupEnd=<!-- End of Colorful --></div>
Flags=0
```



```
[Style2]
StyleName=RedactPara
MarkupStart=<div class="RedactPara">
MarkupEnd=<!-- End of RedactPara --></div>
Flags=2048

[Style3]
StyleName=Code
MarkupStart=<pre>
MarkupEnd=<!-- End of Code --></pre>
Flags=KVSTYLE_PRE
```

Flags for Defining Styles

Flag	Description
KVSTYLE_PRE	The KVSTYLE_PRE flag specifies that white space should be preserved (treated as characters, not word separators), and that mode changes, such as changes in font size within a paragraph, should be ignored. This allows the tags <pre> and </pre> to be used.
KVSTYLE_HEADING[1-6]	The flags KVSTYLE_HEADING[1-6] specify that a given style is to be detected and processed as a heading. Heading flags are exclusive. This means a style cannot be processed as both h1 and h2. By default, Export maps the heading style "Heading 1" to <h1></h1>, and so on, for heading levels 1 through 6. If you use style mappings, the default mapping is overridden. Therefore, you must supply markup for <i>all</i> heading levels. HTML Export uses heading levels to define the overall structure of the HTML output.
KVSTYLE_ORDERLIST	The KVSTYLE_ORDERLIST flag specifies that the style should be tagged as an ordered list. Currently not implemented.
KVSTYLE_UNORDEREDLIST	The KVSTYLE_UNORDEREDLIST flag specifies that the style should be tagged as an unordered list. Currently not implemented.
KVSTYLE_DELETECONTENT	The KVSTYLE_DELETECONTENT flag specifies that the content associated with the style tag should be deleted from the output.
KVSTYLE_ONCONSECUTIVEPARAGRAPHS	The KVSTYLE_ONCONSECUTIVEPARAGRAPHS flag specifies that the style should be applied to consecutive paragraphs of the document. If this flag is used, and two or more paragraphs require the same style, the opening and closing tags that normally appear between each paragraph are not generated.
KVSTYLE_REDACT	The KVSTYLE_REDACT flag is used to hide sensitive or confidential information in the source document. It specifies that the text associated with the style tag should be replaced in the HTML output with a selected character. The default replacement character is "X," but you can specify a

Flags for Defining Styles, continued

Flag	Description
	different replacement character by setting <code>cRedact</code> . See cRedact , on page 243.

Use the COM interface

To map styles by using the COM interface

1. Call the `AddStyleMapping()`, `GetStyleMapping()`, and `RemoveStyleMapping()` methods. See [AddStyleMapping](#), on page 279, [GetStyleMapping](#), on page 281, and [RemoveStyleMapping](#), on page 282.
2. Define the `NumStyles` property. See [NumStyles](#), on page 296.

Use Style Sheets

You can use style sheets to define the overall layout and type specifications of the HTML output. Export can write style sheet information to an external Cascading Style Sheet (CSS) file, or read the information from an existing CSS file during the conversion. The formatting data can either be stored within the output HTML file (inline), or externally in a CSS file. Using an external style sheet makes the HTML output significantly smaller, and allows you to use the same style sheet for many conversions. The style sheet options are enumerated in `KVHTMLStyleSheetType`.

NOTE: Cascading style sheets can be used only with word processing documents.

To enable CSS formatting and output the generated formatting data within the output HTML stream, set `eStyleSheetType` member to `CSS_INLINE`, either directly in the `KVHTMLOptionsEx` structure or in the template file.

NOTE: You cannot retrieve the CSS if you have set `bNoPictures` to **TRUE** (see [KVHTMLOptionsEx](#), on page 237).

To enable CSS formatting and output the generated formatting data in an external CSS file that is referenced in the HTML output as a tag

1. Set `eStyleSheetType` to `CSS_TOFILE`, either directly in the `KVHTMLOptionsEx` structure or in the template file.
2. In the template file, use the `$STYLESHEET` token to specify the URL of the style sheet in the HTML output. The external CSS file is referenced in the output HTML by a LINK statement of the form:

```
<LINK rel="STYLESHEET" href="CSS_file" type="text/css">
```

3. Call the `KVHTMLSetStyleSheet()` function to set the path and file name of the external style sheet. See [KVHTMLSetStyleSheet\(\), on page 204](#).

The sample program `htmlini` provides an example of using style sheets. [htmlini, on page 129](#).

Display Vector Graphics on UNIX and Linux

Export offers the option of rasterizing vector graphic content from source documents into a variety of graphics formats including JPEG, PNG, WMF, and CGM. This solution is implemented with Windows Graphical Device Interface (GDI) code, and therefore is not portable to other platforms.

The output format of vector graphics is defined by the `OutputVectorGraphicType` member in the `KVHTMLOptionsEx` structure, and the options are enumerated in `KVHTMLGraphicType` in `kvhtml.h`. See [KVHTMLOptionsEx, on page 237](#) and [KVHTMLGraphicType, on page 266](#).

To display vector graphics in presentation, word processing, and spreadsheet files on UNIX and Linux, Export can convert the files directly to JPEG by using a Java program named `kvraster.class`. This program uses the Java Abstract Windowing Toolkit (AWT). Alternatively, rather than rasterizing, Export can output text from vector graphics in SVG format, which works the same as on Windows.

To convert the file

1. If rasterizing, add the location of the JRE to the PATH environment variable.
2. Set `OutputVectorGraphicType` to `KVGFX_JPEG` (for raster output), or `KVGFX_SVG` (for text-only vector output) in the `defunix.ini` template file or directly in the API.
3. Convert the document to HTML. The graphics in the document are converted to JPEG or SVG and stored in the output directory.

Search and Highlight Terms

`KeyView` can use the highlighting API to find and highlight specified text strings in the HTML output. Only text strings that exactly match the search term are highlighted. For example, if you specify the term *house*, the string *house* is highlighted in **house**, **houses**, and **housed**, but is not highlighted in the term *housing*. You can define the text attributes used to highlight the text, such as bold, red, or underlined, and the text's target character set.

If a specified term contains HTML code, it is not found. For example, if the phrase *weekly schedule* was specified, the following string in the output HTML would not be found:

```
weekly <b>schedule</b>
```

If you specify multiple terms, and some terms are subsets of other terms, Micro Focus recommends that you specify the superset first. For example,

```
["North American car manufacturers" "car manufacturers" "car"]
```

To specify search terms by using the C API

1. Define the `KVHTMLHighlight` data structure specifying the list of terms, the highlighting attributes, and the case-sensitivity Boolean. See [KVHTMLHighlight](#), on page 231.
2. Call the `fpSetHighlight()` function. See [KVHTMLSetHighlight\(\)](#), on page 202.

Include Revision Information

The revision tracking feature in applications—such as Microsoft Word's **Track Changes**—marks changes to a document (typically, strikethrough for deleted text and underline for inserted text) and tracks each change by reviewer name and date.

If revision tracking was enabled when changes were made to a document, You can configure Export to convert the deleted text and graphics and include revision information in the HTML output. (The deleted content and revision information is excluded from the HTML output by default.)

Content that was added to the document is identified by `<ins>` tags and is underlined when displayed in a browser. Content that was deleted from the document is identified by `` tags and is displayed with strikethrough formatting.

The `<ins>` and `` tags include the following attributes:

- | | |
|-----------------------|--|
| <code>style</code> | This is an optional attribute that is not included by default. You can define a unique HTML style (such as <code>color: red; background: orange</code>) that is applied to each reviewer's edits. See Configure the Revision Style , on page 94. |
| <code>title</code> | The <code>title</code> attribute can contain a prefix and revision information which is displayed in a browser. By default, the prefix is either the text string "inserted:" or "deleted:", and the revision information includes the reviewer name, and the date and time the revision was made.

You can exclude the <code>title</code> attribute or define different text strings for the <code>title</code> attribute (see Configure the Revision Title , on the next page). |
| <code>cite</code> | The <code>cite</code> attribute contains the name of the reviewer who made the revision. |
| <code>datetime</code> | The <code>datetime</code> attribute contains the date and time the revision was made. The date is in ISO-8601 format: YYYY-MM-DDThh:mm:ss. |

For example, the following markup can be generated for inserted text:

```
<ins style="color: red" title="Inserted: JohnD, 2006-04-24T14:47:00"
cite="mailto:JohnD" datetime="2006-04-24T14:47:00">This text was added</ins> in a
previous version.
```

This text is displayed in the browser as:

This text was added in a previous version.

When you hover the cursor over the underlined text in the browser, the text "**Inserted: JohnD, 2006-04-24T14:47:00**" is displayed as a ToolTip.

NOTE: Whether the text is displayed with strikethrough or underline depends on the configuration and capabilities of the browser.

To convert deleted text and graphics and include revision information

1. Call the `fpInit()` or `fpInitWithLicenseData()` function. See [fpInit\(\)](#) or [fpInitWithLicenseData\(\)](#).
2. Define the `KVRevisionMark` structure. See [KVRevisionMark](#), on page 252.
3. Call the `fpHTMLConfig()` function with the following arguments (see [KVHTMLConfig\(\)](#), on page 190):

Argument	Parameter
----------	-----------

<code>nType</code>	<code>KVCFG_INCLREVISIONMARK</code>
<code>nValue</code>	<code>TRUE</code>
<code>pData</code>	A pointer to the <code>KVRevisionMark</code> structure which defines the information that appears in the <code>title</code> attribute and the HTML styles applied to revised content. If you pass <code>NULL</code> to this function, defaults are used.

For example:

```
KVRevisionMark    RMark;
memset(&RMark, 0, sizeof(KVRevisionMark));
KVStructInit(&RMark);
RMark...
(*fpHTMLConfig)(pKVHTML, KVCFG_INCLREVISIONMARK, TRUE, &RMark)
```

The `htmlini` sample program demonstrates this function. See [htmlini](#), on page 129.

4. Call the `fpConvertStream()` or `KVHTMLConvertFile()` function. See [fpConvertStream\(\)](#), on page 171 or [KVHTMLConvertFile\(\)](#), on page 198.

Configure the Revision Title

The `title` attribute can contain a prefix and revision information which is displayed in a browser. By default, the prefix is either the text string "inserted:" or "deleted:" and the reviewer name and date/time are included in the title.

- To exclude the `title` attribute from the `<ins>` and `` tags, set the `RM_TITLE_FLAG` in the `KV_RM_Title` structure to `RMT_Off`. See [KV_RM_Title](#), on page 253.
- To define a different text string for the prefix, specify a new text string in the `pPrefix` member and set the `nSize` and `eCharSet` members of the `KV_RM_Title` structure. See [KV_RM_Title](#), on page 253.
- To change the revision information included in the `title` attribute, set the `RM_TITLE_FLAG` in the `KV_RM_Title` structure. See [RM_Title_Flag](#), on page 276.

The following example sets the prefix as "Added:" and "Removed:" for inserted and deleted text respectively, and only includes the reviewer name in the title attribute:

```
KVRevisionMark    RMark;
char              RMInsPre[16] = "Added:";
char              RMDelPre[16] = "Removed:";
    memset(&RMark, 0, sizeof(KVRevisionMark));
    KVStructInit(&RMark);
    RMark.InsTitle.eFlag = RMT_Author;
    RMark.InsTitle.pPrefix = (BYTE *)&RMInsPre;
    RMark.InsTitle.nSize = strlen(RMInsPre);
    RMark.InsTitle.eCharSet = KVCS_UTF8;
    RMark.DelTitle.eFlag = RMT_Author;
    RMark.DelTitle.pPrefix = (BYTE *)&RMDelPre;
    RMark.DelTitle.nSize = strlen(RMDelPre);
    RMark.DelTitle.eCharSet = KVCS_UTF8;
(*fpHTMLConfig)(pKVHTML, KVCFG_INCLREVISIONMARK, TRUE, &RMark))
```

Configure the Revision Style

You can define a unique HTML style (such as `color: red; background: orange`) that is applied to each reviewer's modifications. This allows you to easily differentiate between multiple reviewers' edits. For example, changes made by JSmith are highlighted in red, changes made by RBrown are highlighted in blue, and so on.

To define revision styles, set the number of revision styles in the `nAuthorStyles` member of the `KVRevisionMark` structure, and use the `ppAuthorStyles` member for each style to define the contents of the `style` attribute. See [KVRevisionMark, on page 252](#).

The following example defines two revision styles:

```
KVRevisionMark    RMark;
char              RMAuthorStyle0[60] = "color: red; background: yellow";
char              RMAuthorStyle1[60] = "color: green; background: silver";
    memset(&RMark, 0, sizeof(KVRevisionMark));
    KVStructInit(&RMark);
    RMark.nAuthorStyles = 2;
    RMark.ppAuthorStyles = (char **)malloc(sizeof(char *)*2);
    if(!RMark.ppAuthorStyles) return(1);
    RMark.ppAuthorStyles[0] = RMAuthorStyle0;
    RMark.ppAuthorStyles[1] = RMAuthorStyle1;
(*fpHTMLConfig)(pKVHTML, KVCFG_INCLREVISIONMARK, TRUE, &RMark))
```

If there are more reviewers than defined styles, KeyView applies all available styles to the reviewers in the order in which they are encountered in the document, and then applies styles starting from the beginning of the list to the remaining reviewers. This process is repeated until all reviewers' edits are highlighted.

NOTE: KeyView does not validate styles. They are written directly to the HTML output.

Generate a Revision Summary

You can configure Export to summarize the changes made to a document in a revision summary file that is generated during the HTML conversion. The summary file is created in the directory where the HTML output is generated. The default file name is `output_filename.revsum.htm`. You can customize this file name by using the `fpGetAnchor` callback function. See [GetAnchor\(\), on page 210](#).

To create a revision summary file, set the `bCreateSummary` flag to `TRUE` in the `KVRevisionMark` structure, and use the `pszRevSumStartBlock` and `pszRevSumEndBlock` members to define the markup and tokens inserted at the beginning and end of the revision summary file.

For example:

```
KVRevisionMark    RMark;
char              RMStartBlock[500] = "<!DOCTYPE HTML PUBLIC "-//W3C//DTD HTML
4.0//EN" > <html> <body>";
char              RMEndBlock[30] = "</body> </html>";
    memset(&RMark, 0, sizeof(KVRevisionMark));
    KVStructInit(&RMark);
    RMark.pszRevSumStartBlock = RMStartBlock;
    RMark.pszRevSumEndBlock = RMEndBlock;
    RMark.bCreateSummary = TRUE;
(*fpHTMLConfig)(pKVHTML, KVCFG_INCLREVISIONMARK, TRUE, &RMark))
```

Extract Text from Text Boxes

By default, the contents of Microsoft Word text boxes are converted to graphics and exported. Alternatively, you can convert the contents of text boxes to text.

NOTE: The extracted text box text is not formatted.

To enable text box extraction

- Add the following to the `formats_e.ini` file:

```
[WordTextBoxOptions]
OutputText=true
```

Convert PDF Files

Export has special configuration options that allow greater control over the conversion of PDF files. These options can improve the fidelity and accuracy of the HTML output.

Use the pdf2sr Reader

In KeyView Export SDK 10.24, the pdf2sr reader was added. It generates a high fidelity raster image of each page in the PDF and will insert text that has a zero opacity value in the HTML to allow for text searching in a web browser.

The pdf2sr reader has the following features:

- supports standard and custom metadata (non-XMP)
- supports basic text extraction
- supports password protected PDFs

The pdf2sr reader has the following limitations:

- does not support logical order
- does not support bidi PDFs
- does not extract subfiles
- does not extract bookmarks from PDFs
- does not give estimations on percent embedded fonts match with display glyphs
- does not support XMP metadata
- does not support headers or footers
- supports annotations only in the raster output, not as searchable text
- does not support content access stream
- does not support tagged content (PDFs)

To specify the pdf2sr reader

1. Open the `formats_e.ini` file with a text editor.
2. In the `[Formats]` section, set the following parameter to the pdf2sr reader:

```
200=pdf2
```

When you use the pdf2sr reader, the output HTML uses HTML5 syntax that might be disabled when using Internet Explorer to view the output. It might prompt the user for permission to run. To disable this behavior, configure Internet Explorer as follows:

1. In Internet Explorer, select **Tools** from the menu.
2. Select **Internet Options**.
3. Click the **Advanced** tab.
4. In the **Security** area, click **Allow active content to run in files on My Computer**.

Use a Graphic-Based Reader

Two graphic-based PDF readers are available. The readers display PDFs by converting each page of the PDF to an image. If you do not want to redistribute the Acrobat Reader with your application, you can use a graphic-based reader instead.

The two readers support different features. Choose the appropriate reader depending on your requirements:

- The kppdfdr reader supports highlighting, annotation, and several other features but also has several graphical limitations.
- The kppdf2rdr reader produces high-fidelity raster images but is a viewer only and does not support highlighting or other features.

Use the kppdfdr Reader

The kppdfdr graphic-based reader has the following features:

- supports vector images
- supports rotation and scaling
- supports multibyte and bidirectional text
- allows you to search text in the output

The kppdfdr reader has the following limitations:

- Embedded fonts in a PDF file are not translated correctly. They are usually displayed using the question mark (?) replacement character.
- If an unsupported font is encountered during conversion, the default font, Times New Roman, is substituted.
- Supports 180 degree rotation only for raster images.
- Supports the following color spaces: DeviceRGB, DeviceGray, DeviceCMYK, CalGray, and CalRGB color spaces. Indexed color spaces are supported as long as they are used with a supported basic color space.
- Does not support hyperlinks.
- Does not extract summary information (metadata).

Use the kppdf2rdr Reader

The kppdf2rdr graphic-based reader produces high-fidelity raster images. However, it has the following limitations:

- Does not support anything beyond viewing, such as text searching.
- Does not support PDFs that contain XFA forms content.

Specify the Graphic-based Reader

By default, the Acrobat control is used to convert PDF documents. Use the following procedure to specify that one of the graphic-based readers be used to convert PDF documents.

To specify the graphic-based reader

1. Open the `formats_e.ini` file with a text editor. The file is installed in the root of the Windows directory.
2. In the `[HiFi]` section, set the following parameter to the graphic-based reader you want to use. Set one of the following values:
 - For the `kppdf rdr` reader:
`200=kppdf rdr`
This is the default setting.
 - For the `kppdf2 rdr` reader:
`200=kppdf2 rdr`
3. Set the `KVCFG_SETHIFIPDF` option in the `fpHTMLConfig()` function (see [KVHTMLConfig\(\)](#), on page 190).

Convert PDF Files to Raster Images

Export allows you to convert each page of a PDF document to a raster image, providing a high-fidelity conversion of the document.

The output format depends on the value of `OutputRasterGraphicType` in `KVHTMLOptionsEx`. See [KVHTMLOptionsEx](#), on page 237.

On UNIX and Linux, the conversion of PDFs to JPEG uses the Java program `kvraster.class`. This Java program requires some setup. See [Display Vector Graphics on UNIX and Linux](#), on page 91.

To use a graphic-based reader to convert PDF documents

1. Specify the graphic-based reader that you want to use.
2. Call the `fpInit()` or `fpInitWithLicenseData()` function. See [fpInit\(\)](#) or [fpInitWithLicenseData\(\)](#).
3. Call the `KVHTMLConfig()` function with the following arguments (see [KVHTMLConfig\(\)](#), on page 190):

Argument	Parameter
<code>nType</code>	<code>KVCFG_SETHIFIPDF</code>
<code>nValue</code>	<code>TRUE</code> (non-zero)
<code>pData</code>	<code>NULL</code>

For example:

```
(*fpHTMLConfig)(pKVHTML, KVCFG_SETHIFIPDF, TRUE, NULL);
```

The `cnv2html` sample program demonstrates this function. See [cnv2html](#), on page 125.

4. Call the `fpConvertStream()` or `KVHTMLConvertFile()` function. See [fpConvertStream\(\)](#), on page 171 or [KVHTMLConvertFile\(\)](#), on page 198.

Convert PDF Files to a Logical Reading Order

The PDF format is primarily designed for presentation and printing of brochures, magazines, forms, reports, and other materials with complex visual designs. Most PDF files do not contain the *logical structure* of the original document—the correct reading order, for example, and the presence and meaning of significant elements such as headers, footers, columns, tables, and so on.

KeyView can convert a PDF file either by using the file's internal unstructured paragraph flow, or by applying a structure to the paragraphs to reproduce the logical reading order of the visual page. Logical reading order enables KeyView to produce PDF files that contain languages that read from right-to-left (such as Hebrew and Arabic) in the correct reading direction.

NOTE: The algorithm used to reproduce the reading order of a PDF page is based on common page layouts. The paragraph flow generated for PDFs with unique or complex page designs might not emulate the original reading order exactly.

For example, page design elements such as drop caps, callouts that cross column boundaries, and significant changes in font size might disrupt the logical flow of the output text.

Logical Reading Order and Paragraph Direction

By default, KeyView produces an *unstructured* text stream for PDF files. This means that PDF paragraphs are extracted in the order in which they are stored in the file, not the order in which they appear on the visual page. For example, a three-column article could be output with the headers and the title at the end of the output file, and the second column extracted before the first column. Although this output does not represent a logical reading order, it accurately reflects the internal structure of the PDF.

You can configure KeyView to produce a *structured* text stream that flows in a specified direction. This means that PDF paragraphs are extracted in the order (logical reading order) and direction (left-to-right or right-to-left) in which they appear on the page.

The following paragraph direction options are available.

Paragraph Direction Option	Description
Left-to-right	Paragraphs flow logically and read from left to right. You should specify this option when most of your documents are in a language that uses a left-to-right reading order, such as English or German.
Right-to-left	Paragraphs flow logically and read from right to left. You should specify this option when most of your documents are in a language that uses a right-to-left reading order, such as Hebrew or Arabic.

Paragraph Direction Option	Description
Dynamic	Paragraphs flow logically. The PDF reader determines the paragraph direction for each PDF page, and then sets the direction accordingly. When a paragraph direction is not specified, this option is used.

Conversions might be slower when logical reading order is enabled. For optimal speed, use an unstructured paragraph flow.

The paragraph direction options control the direction of paragraphs on a page; they do not control the text direction in a paragraph. For example, let us say that a PDF file contains English paragraphs in three columns that read from left to right, but 80% of the second paragraph contains Hebrew characters. If the left-to-right logical reading order is enabled, the paragraphs are ordered logically in the output—title paragraph, then paragraph 1, 2, 3, and so on—and flow from the top left of the first column to the bottom right of the third column. However, the *text* direction of the second paragraph is determined independently of the page by the PDF reader, and is output from right to left.

NOTE: Extraction of metadata is not affected by the paragraph direction setting. The characters and words in metadata fields are extracted in the correct reading direction regardless of whether logical reading order is enabled.

Enable Logical Reading Order

You can enable logical reading order by using either the API or the `formats_e.ini` file. Setting the direction in the API overrides the setting in the `formats_e.ini` file.

Use the C API

To enable PDF logical reading order in the C API

1. Call the `fpInit()` or `fpInitWithLicenseData()` function. See [fpInit\(\)](#) or [fpInitWithLicenseData\(\)](#).
2. Call the `KVHTMLConfig()` function with the following arguments (see [KVHTMLConfig\(\)](#), on [page 190](#)):

Argument	Parameter
<code>nType</code>	<code>KVCFG_LOGICALPDF</code>
<code>nValue</code>	Set to one of the following flags which are defined in <code>kvtypes.h</code> . (see LPDF_DIRECTION , on page 275): <ul style="list-style-type: none"> • <code>LPDF_LTR</code>—Logical reading order and left-to-right paragraph direction. • <code>LPDF_RTL</code>—Logical reading order and right-to-left paragraph direction.

Argument	Parameter
	<ul style="list-style-type: none"> • LPDF_AUTO—Logical reading order. The PDF reader determines the paragraph direction for each PDF page, and then sets the direction accordingly. When a paragraph direction is not specified, this option is used. • LPDF_RAW—Unstructured paragraph flow. This is the default behavior. If logical reading order is enabled, and you want to return to an unstructured paragraph flow, set this flag.
pData	NULL

For example:

```
(*fpHTMLConfig)(pKVHTML, KVCFG_LOGICALPDF, LPDF_RTL, NULL);
```

The `cnv2html` sample program demonstrates this function. See [cnv2html](#), on page 125.

3. Call the `fpConvertStream()` or `KVHTMLConvertFile()` function. See [fpConvertStream\(\)](#), on page 171 or [KVHTMLConvertFile\(\)](#), on page 198.

Use the `formats_e.ini` File

The `formats_e.ini` file is in the directory `install\OS\bin`, where `install` is the path name of the Export installation directory and `OS` is the name of the operating system.

To enable logical reading order by using the `formats_e.ini` file

1. Change the PDF reader entry in the `[Formats]` section of the `formats_e.ini` file as follows:

```
[Formats]
200=lpdf
```

2. Optionally, add the following section to the end of the `formats_e.ini` file:

```
[pdf_flags]
pdf_direction=paragraph_direction
```

where `paragraph_direction` is one of the following:

Flag Description

LPDF_ Left-to-right paragraph direction
LTR

LPDF_ Right-to-left paragraph direction
RTL

LPDF_ The PDF reader determines the paragraph direction for each PDF page, and then sets the direction accordingly. When a paragraph direction is not specified, this option is used.
AUTO

LPDF_ Unstructured paragraph flow. This is the default behavior. If logical reading order is enabled, and you want to return to an unstructured paragraph flow, set this flag.
RAW

Generate a Table of Contents from PDF Bookmarks

When you convert PDF files to HTML by using the basic reader (`pdfsr`), the table of contents is generated from "bookmarks" within the PDF file. The hyperlinked table of contents can appear either at the beginning of the HTML file or in a separate frame.

Micro Focus recommends that you configure the conversion so that the table of contents appears in a separate frame (the template `pdfframe.ini` demonstrates how to do this, see [Set Conversion Options, on page 39](#)). Export uses absolute positioning when converting a PDF file, that is, the text appears in the exact position as in the original document. Table of contents entries do not contain absolute positioning information. Therefore, if the main document and the table of contents are generated in the same output file, the table of contents entries might overlap the body text in the document.

NOTE: When PDF bookmarks are converted to a table of contents in HTML, the generated links do not lead to the exact location of the destination marker, but jump to the page on which the destination marker exists. This is similar to the behavior of the Adobe Acrobat Reader.

Disable Bookmark Conversion

By default, Export converts PDF bookmarks to a table of contents in the HTML output. However, you can configure Export not to generate a table of contents based on the PDF bookmarks.

To prevent conversion of PDF bookmarks

1. Call the `fpInit()` or `fpInitWithLicenseData()` function. See [fpInit\(\)](#) or [fpInitWithLicenseData\(\)](#).
2. Call the `KVHTMLConfig()` function with the following arguments (see [KVHTMLConfig\(\)](#), on page 190):

Argument	Parameter
<code>nType</code>	<code>KVCFG_SUPPRESSTOCPRINTIMAGE</code>
<code>nValue</code>	<code>TRUE</code> (non-zero)
<code>pData</code>	<code>NULL</code>

For example:

```
(*fpHTMLConfig)(pKVHTML, KVCFG_SUPPRESSTOCPRINTIMAGE, TRUE, NULL);
```

The sample programs `Export Demo` and `cnv2html` have `KVCFG_SUPPRESSTOCPRINTIMAGE` enabled. When you use these programs to convert a PDF file with bookmarks, the HTML output does not include a table of contents.

3. Call the `fpConvertStream()` or `KVHTMLConvertFile()` function. See [fpConvertStream\(\)](#), on page 171 or [KVHTMLConvertFile\(\)](#), on page 198.

Convert Invisible Text

PDF documents sometimes contain invisible text. You can search this text in Adobe PDF Reader, but you cannot view it in a web browser.

Toggle Invisible Text

You can add a JavaScript button to the upper right corner of the exported page, which you can click to toggle between invisible and regular text. When you turn on invisible text, the invisible text is displayed and the regular content is hidden; when you turn off invisible text, the invisible text is hidden.

Invisible text is hidden by default. The toggle button only appears if invisible text is detected in the PDF document.

To add an invisible text toggle button

1. Call the `fpInit()` or `fpInitWithLicenseData()` function. See [fpInit\(\)](#) or [fpInitWithLicenseData\(\)](#).
2. Call the `KVHTMLConfig()` function with the following arguments (see [KVHTMLConfig\(\)](#), on page 190):

Argument	Parameter
<code>nType</code>	<code>KVCFG_SETPDFINVISIBLETEXTTOGGLE</code>
<code>nValue</code>	0 (not used)
<code>pData</code>	<code>szButtonName</code>

For example:

```
(*fpHTMLConfig)(pKVHTML, KVCFG_SETPDFINVISIBLETEXTTOGGLE, 0, szButtonName);
```

The `cnv2html` and `htmlini` sample programs demonstrate this function. See [cnv2html](#), on page 125 and [htmlini](#), on page 129.

3. Call the `fpConvertStream()` or `KVHTMLConvertFile()` function. See [fpConvertStream\(\)](#), on page 171 or [KVHTMLConvertFile\(\)](#), on page 198.

NOTE: If no invisible text is detected in the PDF document, no toggle button appears in the HTML output even if you set `KVCFG_SETPDFINVISIBLETEXTTOGGLE`.

Specify Opacity of Invisible Text

Invisible text often occurs in PDF documents when the PDF software processes rasterized images through optical character recognition and then inserts the text in the PDF. You might want to display both the invisible text as well as the rasterized image. To do so, you can set the invisible text *opacity* as determined by an integer from 0 to 100, where 0 hides the invisible text and 100 displays it fully.

Invisible text opacity is set to 0 by default.

To set invisible text opacity

1. Call the `fpInit()` or `fpInitWithLicenseData()` function. See [fpInit\(\)](#) or [fpInitWithLicenseData\(\)](#).
2. Call the `KVHTMLConfig()` function with the following arguments (see [KVHTMLConfig\(\)](#), on page 190):

Argument	Parameter
<code>nType</code>	<code>KVCFG_SETPDFINVISIBLETOPACITY</code>
<code>nValue</code>	<code>iInvisOpacity</code>
<code>pData</code>	<code>NULL</code>

For example:

```
(*fpHTMLConfig)(pKVHTML, KVCFG_SETPDFINVISIBLETOPACITY, iInvisOpacity, NULL);
```

The `htmlini` sample program demonstrates this function. See [htmlini](#), on page 129.

3. Call the `fpConvertStream()` or `KVHTMLConvertFile()` function. See [fpConvertStream\(\)](#), on page 171 or [KVHTMLConvertFile\(\)](#), on page 198.

Convert Rotated Text

By default, rotated text is displayed in its original position, at the original font size, and at 0 degrees rotation in the HTML output. The text is not rotated in the HTML output because text rotation is not supported by HTML.

Because the text is the original size, but might be displayed in a smaller space (at 0 degrees), the text might overlap adjacent text in the HTML output. To avoid this problem, you can specify that the rotated text be removed from its original position and displayed at the bottom of the HTML page on which it appears.

To specify that rotated text be displayed at the bottom of the HTML page

1. Call the `fpInit()` or `fpInitWithLicenseData()` function. See [fpInit\(\)](#) or [fpInitWithLicenseData\(\)](#).
2. Call the `KVHTMLConfig()` function with the following arguments (see [KVHTMLConfig\(\)](#), on page 190):

Argument	Parameter
<code>nType</code>	<code>KVCFG_SETTEXTROTATE</code>
<code>nValue</code>	<code>TRUE</code> (non-zero)
<code>pData</code>	<code>NULL</code>

For example:

```
(*fpHTMLConfig)(pKVHTML, KVCFG_SETTEXTROTATE, TRUE, NULL);
```

The sample programs `Export Demo` and `cnv2html` demonstrate how to use this function. See [Use the Export Demo Program, on page 42](#), and [htmlini, on page 129](#).

3. Call the `fpConvertStream()` or `KVHTMLConvertFile()` function. See [fpConvertStream\(\), on page 171](#) or [KVHTMLConvertFile\(\), on page 198](#).

NOTE: When this feature is enabled, white space is added to the bottom of every HTML page to accommodate any rotated text.

Control Hyphenation

There are two types of hyphens in a PDF document:

- A *soft hyphen* is added to a word by a word processor to divide the word across two lines. This is a discretionary hyphen and is used to ensure proper text flow in justified text.
- A *hard hyphen* is intentionally added to a word regardless of the word's position in the text flow. It is required by the rules of grammar or word usage. For example, compound words, such as "three-week vacation" and "self-confident" contain hard hyphens.

By default, KeyView maintains the source document's soft hyphens in the output HTML to more accurately represent the source document's layout. However, if you are using Export to generate text output for an indexing engine or are not concerned with maintaining the document's layout, Micro Focus recommends that you remove soft hyphens from the HTML output. To remove soft hyphens, you must enable the soft hyphen flag.

NOTE: If the soft hyphen flag is enabled, every hyphen at the end of a line is considered a soft hyphen and removed from the HTML output. If a hard hyphen appears at the end of a line, it is also removed. This might result in an intentionally hyphenated word being extracted without a hyphen.

To remove soft hyphens from the HTML output

1. Call the `fpInit()` or `fpInitWithLicenseData()` function. See [fpInit\(\)](#) or [fpInitWithLicenseData\(\)](#).
2. Call the `KVHTMLConfig()` function with the following arguments (see [KVHTMLConfig\(\), on page 190](#)):

Argument	Parameter
nType	KVCFG_DELSOFTHYPHEN
nValue	TRUE (non-zero)
pData	NULL

For example:

```
(*fpHTMLConfig)(pKVHTML, KVCFG_DELSOFTHYPHEN, TRUE, NULL);
```

3. Call the `fpConvertStream()` or `KVHTMLConvertFile()` function. See [fpConvertStream\(\)](#), on page 171 or [KVHTMLConvertFile\(\)](#), on page 198.

Extract Custom Metadata from PDF Files

To extract custom metadata from your PDF files, add the custom metadata names to the `pdfsr.ini` file provided, and copy the modified file to the `\bin` directory. You can then extract metadata as you normally would.

The `pdfsr.ini` is in the directory `samples\pdfini`, and has the following structure:

```
<META>
<TOTAL>total_item_number</TOTAL>,
/metadata_tag_name datatype,
</META>
```

Parameter	Description
<code>total item number</code>	The total number of metadata tags that are listed.
<code>metadata_tag_name</code>	The metadata tag name used in the PDF files.
<code>datatype</code>	The data type of the metadata field. Data types are defined in <code>KVSumInfoType</code> . See KVSumInfoType , on page 271.

For example:

```
<META>
<TOTAL> 4 </TOTAL>
/part_number      INT4
/volume           INT4
/purchase_date    DATETIME
/customer         STRING
</META>
```

NOTE: Metadata cannot be extracted from PDFs when the PDF is converted to JPEG. See [Convert PDF Files to Raster Images](#), on page 98.

Convert Spreadsheet Files

Export has special configuration options that allow greater control over the conversion of spreadsheet files.

Convert Hidden Text in Microsoft Excel Files

Normally, Export does not convert hidden text from a Microsoft Excel spreadsheet because it is assumed that the text should not be exposed. You can change this default behavior and convert text in hidden rows, columns, and sheets by adding the following lines to the `formats_e.ini` file:

```
[Options]
gethiddeninfo=1
```

Convert Headers and Footers in Microsoft Excel 2003 Files

Normally, Export does not convert headers and footers from Microsoft Excel 2003 spreadsheets. You can change this default behavior and convert headers and footers by adding the following lines to the `formats_e.ini` file:

```
[Options]
ShowHeaderFooter=1
```

Specify Date and Time Format on UNIX Systems

In Microsoft Excel you can choose to format dates and times according to the system locale. On Windows, KeyView uses the system locale settings to determine how these dates and times should be formatted. In other operating systems, KeyView uses the U.S. short date format (*mm/dd/yyyy*). You can change this by specifying the formats you wish to use in the `formats.ini` file.

To specify the system date and time format on UNIX systems

- In the `formats.ini` file, specify the following options:
 - `SysDateTime`. The format to use when a cell is formatted using the system format including both the date and the time.
 - `SysLongDate`. The format to use when a cell is formatted using the system long date format.
 - `SysShortDate`. The format to use when a cell is formatted using the system short date format.
 - `SysTime`. The format to use when a cell is formatted using the system time format.

NOTE: These values cannot contain spaces.

For example, if you specify `SysDateTime=%d/%m/%Y`, dates and times are extracted in the following format:

28/02/2008

The format arguments are the same as those for the `strftime()` function. Refer to the following web page for more information.

See <http://linux.die.net/man/3/strftime> for more information.

Convert Very Large Numbers in Spreadsheet Cells to Precision Numbers

You can export numbers in Microsoft Excel files and write them to the output without formatting. By default, numbers are exported in the format specified by the Excel file (for example, *General*, *Currency*, and *Date*). Spreadsheets might contain cells that have very large numbers in them. Excel displays the numbers in a scientific notation that rounds or truncates the numbers.

To export numbers without formatting, add the following options in the following lines to the `formats_e.ini` file:

```
[Options]
ignoredefnumformats=1
```

Extract Microsoft Excel Formulas

Normally, the actual value of a formula is extracted from an Excel spreadsheet; the formula from which the value is derived is not included in the output. However, KeyView enables you to include the value as well as the formula in the output. For example, if Export is configured to extract the formula and the formula value, the output might look like this:

```
245 = SUM(B21:B26)
```

The calculated value from the cell is 245, and the formula from which the value is derived is SUM (B21:B26).

NOTE: Depending on the complexity of the formulas, enabling formula extraction might result in slightly slower performance.

To set the extraction option for formulas, add the following lines to the `formats_e.ini` file:

```
[Options]
getformulastring=option
```

where *option* is one of the following:

Option	Description
0	Extract the formula value only. This is the default.
	Set this option if formula extraction is enabled, and you want to return to the default.
1	Extract the formula only.
2	Extract the formula and the formula value.

NOTE: If a function in a formula is not supported or is invalid, and option 1 or 2 is specified, only the calculated value is extracted. See the following table for a list of supported functions.

When formula extraction is enabled, Export can extract Microsoft Excel formulas containing the functions listed in the following table:

Supported Microsoft Excel Functions

=ABS()	=ACOS()	=AND()	=AREAS()
=ASIN()	=ATAN2()	=ATAN2()	=AVERAGE()
=CELL()	=CHAR()	=CHOOSE()	=CLEAN()
=CODE()	=COLUMN()	=COLUMNS()	=CONCATENATE()
=COS()	=COUNT()	=COUNTA()	=DATE()
=DATEVALUE()	=DAVERAGE()	=DAY()	=DCOUNT()
=DDB()	=DMAX()	=DMIN()	=DOLLAR()
=DSTDEV()	=DSUM()	=DVAR()	=EXACT()
=EXP()	=FACT()	=FALSE()	=FIND()
=FIXED()	=FV()	=GROWTH()	=HLOOKUP()
=HOUR()	=ISBLANK()	=IF()	=INDEX()
=INDIRECT()	=INT()	=IPMT()	=IRR()
=ISERR()	=ISERROR()	=ISNA()	=ISNUMBER()
=ISREF()	=ISTEXT()	=LEFT()	=LEN()
=LINEST()	=LN()	=LOG()	=LOG10()
=LOGEST()	=LOOKUP()	=LOWER()	=MATCH()
=MAX()	=MDETERM()	=MID()	=MIN()
=MINUTE()	=MINVERSE()	=MIRR()	=MMULT()
=MOD()	=MONTH()	=N()	=NA()
=NOT()	=NOW()	=NPER()	=NPV()
=OFFSET()	=OR()	=PI()	=PMT()
=PPMT()	=PRODUCT()	=PROPER()	=PV()
=RATE()	=REPLACE()	=REPT()	=RIGHT()
=ROUND()	=ROUND()	=ROW()	=ROWS()
=SEARCH()	=SECOND()	=SIGN()	=SIN()
=SLN()	=SQRT()	=STDEV()	=SUBSTITUTE()
=SUM()	=SYD()	=T()	=TAN()
=TEXT()	=TIME()	=TIMEVALUE()	=TODAY()

```
=TRANPOSE()  =TREND()      =TRIM()      =TRUE()  
=TYPE()      =UPPER()      =VALUE()     =VAR()  
=VLOOKUP()   =WEEKDAY()    =YEAR()
```

Set Minimum Image Size

You can set a minimum size limit for the images to export from spreadsheet files. This option can improve performance for documents that have lots of very small images.

To set the minimum image size, add the following lines to the `formats_e.ini` file:

```
[ss_flags]  
process_images_with_min_width=N  
process_images_with_min_height=M
```

where *N* and *M* are the minimum image dimensions, in pixels. For example:

```
[ss_flags]  
process_images_with_min_width=150  
process_images_with_min_height=250
```

Convert Presentation Files

Export has special configuration options that allow greater control over the conversion of presentation files.

Convert Presentation Files to Raster Images

Export allows you to convert each slide in a presentation document to a raster image, providing a high-fidelity conversion of the document.

The output format depends on the value of `bRasterizeFiles` in `KVHTMLOptionsEx`. See [KVHTMLOptionsEx, on page 237](#).

Convert Presentation Files to a Logical Reading Order

Some presentation files do not store the logical structure of the original document—the correct reading order, for example, and the presence and meaning of significant elements such as headers, footers, columns, tables, and so on.

In general, when you convert a presentation slide to a raster image, the output file retains the logical reading order because it uses the correct coordinates for each element in the output. However, if you do not use the `bRasterizeFiles` option in `KVHTMLOptionsEx` to produce a raster image, you might find that the export process generates output for some files that does not match the logical reading order.

When you do not want to rasterize your presentation files, you can use the `formats_e.ini` file to retain the logical reading order in your files.

The `formats_e.ini` file is in the directory `install\OS\bin`, where `install` is the path name of the Export installation directory and `OS` is the name of the operating system.

To enable logical reading order by using the `formats_e.ini` file

- In the `formats_e.ini` file, find the `[Options]` section, and set `LogicalOrder` to `1`.

For example:

```
[Options]
LogicalOrder=1
```

Mitigate Text Wrapping

When KeyView cannot render text in exactly the same way as in the original presentation (for example because exact font information is not available), the text might end up too large for the box that contains it. In this case, it might clip at the box edge, or overwrite other text.

To mitigate this effect, you can use the `GraphicFontScale` option to reduce the size of all text rendered to images by a certain amount.

NOTE: This option is available on Microsoft Windows platforms only.

The default value is `1`. You can set it to a value between `0.01` and `100.0` to scale the text rendered into images by this amount. Setting `GraphicFontScale` to slightly less than one can help prevent truncation and wrapping when KeyView does not have access to exactly the correct font. For example:

```
[Options]
GraphicFontScale=0.95
```

Convert XML Files

Export enables you to extract all or selected content from source XML files (see [Configure Element Extraction for XML Documents](#), below). It detects the following XML formats:

- generic XML
- Microsoft Office 2003 XML (Word, Excel, and Visio)
- StarOffice/OpenOffice XML (text document, presentation, and spreadsheet)

See [File Format Detection](#), on page 454 for more information on format detection.

Configure Element Extraction for XML Documents

When you convert XML files, you can specify which elements and attributes are extracted according to the file's format ID or *root element*. This is useful when you want to extract only relevant text elements,

such as abstracts from reports, or a list of authors from an anthology.

A root element is an element in which all other elements are contained. In the XML sample below, `book` is the root element:

```
<book>
  <title>XML Introduction</title>
  <product id="33-657" status="draft">XML Tutorial</product>
  <chapter>Introduction to XML
    <para>What is HTML</para>
    <para>What is XML</para>
  </chapter>
  <chapter>XML Syntax
    <para>Elements must have a closing tag</para>
    <para>Elements must be properly nested</para>
  </chapter>
</book>
```

For example, you could specify that when converting files with the root element `book`, the element `title` is extracted as metadata, and only `product` elements with a `status` attribute value of `draft` are extracted.

When you extract an element, the child elements within the element are also extracted. For example, if you extract the element `chapter` from the sample above, the child element `para` is also extracted.

Export defines default element extraction settings for the following XML formats:

- generic XML
- Microsoft Office 2003 XML (Word, Excel, and Visio)
- StarOffice/OpenOffice XML (text document, presentation, and spreadsheet)

These settings are defined internally and are used when converting these file formats; however, you can modify their values.

In addition to the default extraction settings, you can also add custom settings for your own XML document types. If you do not define custom settings for your own XML document types, the settings for the generic XML are used.

Modify Element Extraction Settings

You can modify configuration settings for XML documents by using the API.

You can also test this feature by modifying the `kvxconfig.ini` file, and passing it to the sample program `htmlini`.

NOTE: You can use customized element extraction settings only when converting files in process. When converting out of process, the default extraction settings are used.

Use the C API

You can use the C API to modify the settings for the standard XML document types or add configuration settings for your own XML document types.

To modify settings

1. Call the [fpInit\(\)](#) or [fpInitWithLicenseData\(\)](#) function.
2. Define the `KVXConfigInfo` structure. See [KVXConfigInfo](#), on page 227.
3. Call the `KVHTMLConfig()` function with the following arguments (see [KVHTMLConfig\(\)](#), on page 190):

Argument	Parameter
<code>nType</code>	<code>KVCFG_SETXMLCONFIGINFO</code>
<code>nValue</code>	<code>0</code>
<code>pData</code>	address of the <code>KVXConfigInfo</code> structure

For example:

```
KVXConfigInfo xinfo; /* populate xinfo */  
(*fpHTMLConfig)(pKVHTML, KVCFG_SETXMLCONFIGINFO, 0, &xinfo);
```

4. Repeat steps 2 and 3 until the settings for all the XML document types you want to customize are defined.
5. Call the `fpConvertStream()` or `KVHTMLConvertFile()` function. See [fpConvertStream\(\)](#), on page 171 or [KVHTMLConvertFile\(\)](#), on page 198.

Modify Element Extraction Settings in the `kvxconfig.ini` File

The `kvxconfig.ini` file contains default element extraction settings for supported XML formats. The file is in the directory `install\OS\bin`, where `install` is the path name of the Export installation directory and `OS` is the name of the operating system.

For example, the following entry defines extraction settings for the Microsoft Visio 2003 XML format:

```
[config3]  
eKVFormat=MS_Visio_XML_Fmt  
szRoot=  
szInMetaElement=DocumentProperties  
szExMetaElement=PreviewPicture  
szInContentElement=Text  
szExContentElement=  
szInAttribute=
```

The following options are available.

Configuration Option	Description
<code>eKVFormat</code>	The format ID as detected by the KeyView detection module. This determines the file type to which these extraction settings apply. See File Format Detection , on page 454 for more information on format ID values.

Configuration Option	Description
	<p>If you are adding configuration settings for a custom XML document type, this is not defined.</p>
szRoot	<p>The file's root element. When the format ID is not defined, the root element is used to determine the file type to which these settings apply.</p> <p>To further qualify the element, specify its namespace. See Specify an Element's Namespace and Attribute, on the next page.</p>
szInMetaElement	<p>The elements extracted from the file as metadata. All other elements are extracted as text.</p> <p>Multiple entries must be separated by commas. To further qualify the element, specify its namespace, its attributes, or both. See Specify an Element's Namespace and Attribute, on the next page.</p>
szExMetaElement	<p>The child elements in the included metadata elements that are not extracted from the file as metadata. For example, the default extraction settings for the Visio XML format extract the DocumentProperties element as metadata. This element includes child elements such as Title, Subject, Author, Description, and so on. However, the child element PreviewPicture is defined in szExMetaElement because it is binary data and should not be extracted.</p> <p>You cannot exclude any metadata elements from the output for StarOffice files. All metadata is extracted regardless of this setting.</p> <p>Multiple entries must be separated by commas. To further qualify the element, specify its namespace, its attributes, or both. See Specify an Element's Namespace and Attribute, on the next page.</p>
szInContentElement	<p>The elements extracted from the file as content text. Enter an asterisk (*) to extract all elements including child elements.</p> <p>Multiple entries must be separated by commas. To further qualify the element, specify its namespace, its attributes, or both. See Specify an Element's Namespace and Attribute, on the next page.</p>
szExContentElement	<p>The child elements in the included content elements that are not extracted from the file as content text.</p> <p>Multiple entries must be separated by commas. To further qualify the element, specify its namespace, its attributes, or both. See Specify an Element's Namespace and Attribute, on the next page.</p>
szInAttribute	<p>The attribute values extracted from the file. If attributes are not defined here, attribute values are not extracted.</p> <p>Enter the namespace (if used), element name, and attribute name in the following format:</p> <p><i>namespace:elementname@attributename</i></p>

Configuration Option	Description
	For example: <code>keyview:division@name</code> Separate multiple entries with commas.

Specify an Element's Namespace and Attribute

To further qualify an element, you can specify that the element must exist in a certain namespace, must contain a specific attribute, or both. To define the namespace *and* attribute of an element, enter the following:

```
ns_prefix:elemname@attribname=attribvalue
```

You must enclose attribute values that contain space in quotation marks.

For example, the following entry:

```
bg:language@id=xml
```

extracts a language element in the namespace `bg` that contains the attribute name `id` with the value of `"xml"`. This entry extracts the following element from an XML file:

```
<bg:language id="xml">XML is a simple, flexible text format derived from  
SGML</bg:language>
```

but does not extract:

```
<bg:language id="sgml">SGML is a system for defining markup  
languages.</bg:language>
```

or

```
<adv:language id="xml">The namespace should be a Uniform Resource Identifier  
(URI).</adv:language>
```

Add Configuration Settings for Custom XML Document Types

You can define element extraction settings for custom XML document types by adding the settings to the `kvxconfig.ini` file. For example, for files containing the root element `keyviewxml`, you could add the following section to the end of the initialization file:

```
[config101]  
eKVFormat=  
szRoot=keyviewxml  
szInMetaElement=dc:title,dc:meta@title,dc:meta@name=title  
szExMetaElement=  
  
szInContentElement=keyview:division@name=dev,keyview:division@name=export,p@style="Heading 1"  
szExContentElement=  
szInAttribute=keyview:division@name
```

The custom extraction settings must be preceded by a section heading named `[configN]`, where *N* is an integer that starts at 100 and increases by 1 for each additional file type (for example, `[config100]`, `[config101]`, `[config102]`, and so on). The default extraction settings for the supported XML formats are numbered `config0` to `config99`. Currently only 0 to 6 are used.

Because a custom XML document type is not recognized by the KeyView detection module, the format ID is not defined. The file type is identified by the file's root element only.

If a custom XML document type is not defined in the `kvxconfig.ini` file or by the `KVHTMLConfig()` function, the default extraction settings for a generic XML document are used.

Show Hidden Data

Microsoft Word, Excel, and PowerPoint documents contain hidden information, some of which is shown by default when exported, and some of which is hidden by default. There are several options that allow you to determine which types of hidden data are shown.

Hidden Data in Microsoft Documents

You can show several types of hidden data from Microsoft Word, Excel, and PowerPoint documents, each of which has a corresponding flag in the [KVHTMLConfig\(\)](#), [on page 190](#) function, which you can set to change the default behavior. The following table lists each data type, its default behavior, and its corresponding configuration API flag.

Hidden data settings

Hidden Data Type	Default Behavior	Configuration API Flag
Microsoft Word		
Comments ¹	Shown ²	KVCFG_WP_NOCOMMENTS
Hidden text	Hidden	KVCFG_WP_SHOWHIDDENTEXT
Date field codes	Calculated date	KVCFG_WP_SHOWDATEFIELDPCODE
File name field codes	Document file name	KVCFG_WP_SHOWFILENAMEFIELDPCODE
Microsoft Excel		
Hidden information	Hidden	KVCFG_SS_SHOWHIDDENINFOR
Comments	Hidden	KVCFG_SS_SHOWCOMMENTS
Formulas	Calculated value	KVCFG_SS_SHOWFORMULA

¹Word comment settings can also be toggled with a configuration parameter in the `formats_e.ini` file. See [Toggle Word Comment Settings in the formats_e.ini File, on the next page](#).

²Shown by default in documents from Microsoft Word 97 and later.

Hidden data settings, continued

Hidden Data Type	Default Behavior	Configuration API Flag
Microsoft PowerPoint		
Hidden slides	Shown	KVCFG_PG_HIDEHIDDENSLIDE
Comments	Shown ¹	KVCFG_PG_HIDECOMMENT
Comments slide	Hidden	KVCFG_PG_SHOWCOMMENTSSSLIDE ²
Slide notes ³	Hidden	KVCFG_PG_SHOWSLIDENOTES

To toggle the display of any type of hidden data

- Use the configuration API and set the third parameter to **TRUE** or **FALSE**:

```
(*fpHTMLConfig)(pKVHTML, KVCFG_WP_NOCOMMENTS, TRUE, NULL)
```

In this example, comments will not be exported from Word documents.

NOTE: The third parameter affects the *default* behavior. To change the default behavior, set it to **TRUE**.

For more information, see [KVHTMLConfig\(\)](#), on page 190.

Toggle Word Comment Settings in the `formats_e.ini` File

Microsoft Word 97 to 2003 comment settings can also be controlled through a parameter in the `formats_e.ini` file.

The `formats_e.ini` file is in the directory `install\OS\bin`, where `install` is the path name of the Export installation directory and `OS` is the name of the operating system.

To toggle comment output in `formats_e.ini`

1. Open the `formats_e.ini` file in a text editor.
2. Under `[Options]`, add the `WP_NOCOMMENTS` parameter and set it to `0` to show comments, or `1` to hide comments. For example:

```
[Options]  
WP_NOCOMMENTS=1
```

¹Shown by default in Microsoft PowerPoint 97 to 2000 documents.

²This setting affects PowerPoint 2003 and 2007 only.

³PowerPoint slide note settings can also be toggled with a configuration parameter in the `formats_e.ini` file. See [Toggle PowerPoint Slide Note Settings in the `formats_e.ini` File, on the next page](#).

NOTE: The `KVCFG_WP_NOCOMMENTS` configuration API flag overrides the setting in `formats_e.ini`.

Toggle PowerPoint Slide Note Settings in the `formats_e.ini` File

Microsoft PowerPoint slide note settings can also be controlled through a parameter in the `formats_e.ini` file.

The `formats_e.ini` file is in the directory `install\OS\bin`, where `install` is the path name of the Export installation directory and `OS` is the name of the operating system.

To toggle slide note output in `formats_e.ini`

1. Open the `formats_e.ini` file in a text editor.
2. Under `[Options]`, add the `ShowSlideNotes` parameter and set it to `1` to show slide notes, or `0` to hide slide notes. For example:

```
[Options]
ShowSlideNotes=1
```

NOTE: The `KVCFG_PG_SHOWSLIDENOTES` configuration API flag overrides the setting in `formats_e.ini`.

Exclude Japanese Guide Text

This option prevents output of Japanese phonetic guide text when Microsoft Excel (`.xlsx`) files are processed.

To prevent output of Japanese phonetic guide text

- Set `NoPhoneticGuides` to `TRUE` in the `formats_e.ini` file:

```
[Options]
NoPhoneticGuides=TRUE
```

You can also enable this option programatically when filtering by passing `KVFLT_NOPHONETICGUIDES` to `fpFilterConfig`.

Source Code Identification

When KeyView auto-detects a file that contains source code, it can attempt to identify the programming language that it is written in.

NOTE: Source code identification is available only on Windows 64-bit, Linux 64-bit, and macOS 64-

bit platforms.

You can set source code identification to different levels.

Option	Description
KVSOURCECODE_OFF	Do not enable source code identification.
KVSOURCECODE_ENABLED	Enable source code identification for the most common source code formats.
KVSOURCECODE_EXTENDED	Enable source code identification for all supported source code formats. This option might lead to false positives in some cases (for example, a C++ file might get identified as a rarer format).

For the complete list of source code formats supported for both options, see [Supported Formats, on page 314](#).

You can enable source code identification by setting the appropriate level in the `formats_e.ini` file. For example:

```
[Options]  
SourceCodeDetection=KVSOURCECODE_ENABLED
```

Partitioning

To increase the flexibility of KeyView output, you can output the HTML rendering of different parts of a file to different partitions. These partitions are snippets of HTML output for a given portion of the file. The calling code can then combine these partitions into the desired output structure. This option allows for highly flexible and customizable output.

For each partition, KeyView returns information about the partition, such as dimensions and background color, which you can use to better reflect the appearance of the original document in your output. For an example of how to do this, see [HTML Export Reference Implementation, on page 26](#).

You can enable partitioning by using `fpSetPartitionOn`. You can obtain information about each partition by using `fpGetPartitionInfoList`.

The KeyView interface allows you to create new partitions for several reasons. The following table lists the available reasons.

Partition Start Reason	Description
Format Standard	This start reason applies only to documents that were converted by using the presentation graphic or spreadsheet structured access layers. The format standard start reason is:

Partition Start Reason	Description
	<ul style="list-style-type: none"> • a new worksheet for spreadsheet formats • a table for database formats • a slide for presentation graphic formats • a graphic for image/graphic formats
Heading	A heading in a Word Processing document.
Hard Break	A hard page break in a Word Processing document.
Block Size	The block size limit was reached.
Page Size Change	A page size change in a Word Processing document.

Configure the Proxy for RMS

When KeyView needs to access contents that are protected by the Microsoft Rights Management System (RMS), it must make HTTP requests. By default, KeyView uses the system proxy settings for these requests.

To use different proxy settings, you can configure them in the [RMS] section of the `formats_e.ini` configuration file. The following table describes the available options.

Parameter	Description
UseSystemProxy	<p>Whether to obtain details about your HTTP proxy from the system. By default, this parameter is set to TRUE, which means:</p> <ul style="list-style-type: none"> • On Microsoft Windows platforms, KeyView reads the proxy settings that are configured in the Windows Control Panel. • On Linux, KeyView reads the proxy settings from environment variables such as <code>HTTP_PROXY</code> and <code>HTTPS_PROXY</code>. <p>You can use <code>UseSystemProxy</code> instead of setting the other proxy parameters (<code>ProxyHost</code>, <code>ProxyPort</code>, <code>ProxyUsername</code>, and <code>ProxyPassword</code>). When <code>UseSystemProxy</code> is set to TRUE, you must remove these other parameters from your configuration.</p> <p>Set <code>UseSystemProxy</code> to FALSE to use different proxy settings. In this case you must set at least <code>ProxyHost</code> and <code>ProxyPort</code>.</p>
ProxyHost	The host name or IP address of the proxy server.

Parameter	Description
ProxyPassword	The password to use to authenticate with the proxy server.
ProxyPort	The port of the proxy server to use to access the repository. This port must be greater than 0, and less than 65535.
ProxyUsername	The user name to use to authenticate with the proxy server.

Chapter 5: Sample Programs

This section describes the sample programs provided with HTML Export.

• Introduction	122
• tstxtract	124
• cnv2html	125
• cnv2htmlloop	126
• onefile	128
• index	128
• io_samp	128
• htmlini	129
• callback	131
• jvtree_demo	131
• JVTree	132
• kvhtmlexport	132
• Export Demo	133
• Template Wizard	133
• comsamp	138
• htmlloop	138

Introduction

The sample programs demonstrate how to use the C and COM implementations of HTML Export. The sample code is intended to provide a starting point for your own applications or to be used for reference purposes.

The source code and makefile for each program are in the following directory, where *install* is the path of the Export installation directory, and *program_name* is the name of the sample program:

```
install\htmlexport\programs\program_name
```

In addition to the sample programs, Micro Focus provides a reference implementation for HTML Export. For more information, see [HTML Export Reference Implementation, on page 26](#).

C Sample Programs

The C sample programs demonstrate how to use the C implementation of HTML Export. The following sample programs are provided:

- [tstxtract, on page 124](#)

- [cnv2html](#), on page 125
- [cnv2htmlloop](#), on page 126
- [onfile](#), on page 128
- [index](#), on page 128
- [io_samp](#), on page 128
- [htmlini](#), on page 129
- [callback](#), on page 131

You can use the `tstextract`, `cnv2html`, `cnv2htmlloop`, and `htmlini` sample programs on Windows and UNIX. All other sample programs are for Windows only.

NOTE: The sample programs do not parse white space in file names. If your file names contain spaces, use quotation marks around the entire path name. Inserting quotation marks around the file name only does not work.

The sample programs pass license information to KeyView using `fpInitWithLicenseData()`. This is the method recommended by Micro Focus. Before the sample programs can be compiled, you must replace the parameters `YOUR_LICENSE_ORGANIZATION` and `YOUR_LICENSE_KEY` in the `fpInitWithLicenseData()` function call with your license information.

To compile the sample programs, use the makefiles provided in the sample programs' directory. Ensure the HTML Export `include` directory is specified in the include path of the project. After the executables are compiled and built, you must place them in the same directory as the HTML Export libraries.

NOTE: Compiled binaries are provided for some of the sample programs, in the `PLATFORM/bin` folder. These have an embedded trial license, which expires approximately five months after release.

Compile the Visual Basic Sample Program

To compile Export Demo, use the Visual Studio project file (`demo_vb.vbp`) in the directory `install\htmlexport\programs\ExportDemo`, where `install` is the path of the Export installation directory. The executable is in the same directory.

COM Sample Program

The COM API is a COM interface to HTML Export and is available on 32-bit Windows platforms only. The interface is well suited for Visual Basic and Visual J++ programmers. The interface is an `IDispatch` interface, and can therefore be used with scripting environments such as Active Server Pages.

The following COM sample programs are provided:

- [Template Wizard, on page 133](#)
- [comsamp, on page 138](#)
- [htmlloop, on page 138](#)

To compile the Template Wizard, use the Visual Studio project file (`htmwbwzd.vbp`) in the `install\htmllexport\programs\wizard` directory, where `install` is the path name of the Export installation directory.

To compile the `comsamp` sample program, use the Visual Studio project file (`comsamp.vbp`) in the `install\htmllexport\programs\comsamp` directory.

To compile `htmlloop`, use the Visual Studio project file (`htmlloop2.dsw`) in the `install\htmllexport\programs\htmlloop` directory.

tstxtract

The `tstxtract` sample program demonstrates the File Extraction API. It opens a file, extracts subfiles from the file, and repeats the extraction process until all subfiles are extracted. It also demonstrates how to extract the default set of metadata and pass integer or string names to extract specific metadata. After the files are extracted, you can convert the files by using one of the conversion sample programs.

The source code for the `tstxtract` sample program is the same for the Filter and Export SDKs. A flag in the makefile specifies whether the program is compiled for Filter, HTML Export, or XML Export.

To run `tstxtract`, type the following at the command line:

```
tstxtract [options] input_file output_directory bin_directory
```

where *options* is one or more of the following.

Option	Description
-c charset	Specify the target character set, for example <code>KVCS_SJIS</code> . See Coded Character Sets, on page 432 for a full list of supported character sets.
-cf keyfile1, keyfile2,...	Specify one or more credential files (private keys) to use to decrypt encrypted <code>.EML</code> , <code>.MBX</code> , <code>.PST</code> , or <code>.MSG</code> files.
-l logfile	Specify the path and file name of the log file in which metadata is written.
-lm	Retrieve metadata and write the data to the log file.
-lms metaname1, metaname2,...	Retrieve metadata with string metanames and write the data to the log file for <code>.MSG</code> , <code>.EML</code> , <code>.MBX</code> , and <code>.NSF</code> files.
-lmi metaint1,	Retrieve metadata with integer (hexadecimal) metanames and write the data to the log file for <code>.PST</code> files.

Option	Description
metaint2,...	
-lma	Retrieve all metadata from an .NSF file and write the data to the log file.
-r	Recursively extract second-level subfiles to the specified output directory. For example, if a .ZIP file contains a Microsoft Word file and the Word file contains an embedded Microsoft Excel file, set the -r option to extract both the Word and Excel files. If this option is not set, only first-level subfiles are extracted. For the example above, only the Word file would be extracted.
-msg	Extract mail messages in a .PST file as an .MSG file, including all of its attachments. If this flag is not set, the mail message is extracted as text. This option applies to PST files on Windows only.
-f	Extract the formatted version of the message body (HTML or RTF) from mail files when possible. If neither an HTML nor RTF version of the message body exists in the mail file, then it is extracted as plain text. If this flag is not set, the message body is extracted as plain text when possible.
-t	Preserve the timestamp of embedded files when possible.
-h	Extract hidden text.

input_file is the full path and file name of the source document.

output_directory is the directory to which the files will be extracted.

bin_directory is the path to the Export bin directory. This is required if you do not run the program from the *install\Export SDK\bin* directory.

cnv2html

The *cnv2html* sample program creates a single, formatted HTML output file. It is called by the Export Demo sample program, but can also be used on its own.

To run *cnv2html*, type the following at the command line:

```
cnv2html [options] inputfile outputfile
```

where:

options is one or more of the options listed in [Options for cnvhtml, on the next page](#).

inputfile is the full path and file name of the source document.

outputfile is the full path and file name of the HTML output file.

The following options are available.

Options for `cnvhtml`

Option	Description
<code>-c KVCFG_SETHIFIPDF</code>	<p>This option specifies the type of reader used to convert PDF documents. In Export, you can convert PDF documents by using either the graphic-based PDF reader, named <code>kppdfldr</code>, or the basic PDF reader, named <code>pdfsr</code>. For more information on each reader, see Convert PDF Files to Raster Images, on page 98.</p> <p>By default, the basic reader (<code>pdfsr</code>) is used to convert PDF documents.</p>
<code>-c KVCFG_SETTEXTROTATE</code>	<p>This option specifies that rotated text should be displayed at the bottom of a page on which it appears. By default, rotated text in a file is displayed in its original position, at the original font size, and at 0 degrees rotation. The text is not rotated in the output because text rotation is not supported by HTML. See Convert Rotated Text, on page 104 for more information.</p> <p>Currently, this configuration option applies only to PDF files.</p>
<code>-c KVCFG_DELSOFTHYPHEN</code>	<p>This option specifies that soft hyphens in PDF files are deleted from the converted output. See Control Hyphenation, on page 105.</p>
<code>-c KVCFG_SETPDFINVESTEXTTOGGLE</code> <i>ButtonName</i>	<p>y.</p>
<code>-pdfauto</code>	<p>This option specifies that PDF files are output in a logical reading order. The PDF reader determines the paragraph direction (left-to-right or right-to-left) for each PDF page, and then sets the direction accordingly. See Convert PDF Files to a Logical Reading Order, on page 99.</p>
<code>-pdfltr</code>	<p>This option specifies that PDF files are output in a logical reading order, and the paragraph direction is left to right. See Convert PDF Files to a Logical Reading Order, on page 99.</p>
<code>-pdfrtl</code>	<p>This option specifies that PDF files are output in a logical reading order, and the paragraph direction is right to left. See Convert PDF Files to a Logical Reading Order, on page 99.</p>
<code>-pdfraw</code>	<p>This option specifies that PDF files are output in an unstructured paragraph flow. This is the default. Set this flag if logical reading order is enabled, and you want to return to an unstructured paragraph flow. See Convert PDF Files to a Logical Reading Order, on page 99.</p>

cnv2htmlloop

The `cnv2htmlloop` sample program creates a single, formatted HTML output file, but unlike `cnv2html1`, it converts the file out of process. See [Convert Files Out of Process, on page 31](#) for more information on

out of process conversions.

To run `cnv2htmlloop`, type the following at the command line:

```
cnv2htmlloop [options] inputfile outputfile
```

where:

options is one or more of the options listed in [Options for `cnv2htmlloop`, below](#).

inputfile is the full path and file name of the source document.

outputfile is the full path and file name of the HTML output file.

The following options are available.

Options for `cnv2htmlloop`

Option	Description
-f	Convert by using out-of-process file mode (default)
-s	Convert by using out-of-process stream mode
-c KVCFG_SETHIFIPDF	This option specifies the type of reader used to convert PDF documents. In Export, you can convert PDF documents by using either the graphic-based PDF reader, named <code>kppdfldr</code> , or the basic PDF reader, named <code>pdfsr</code> . For more information on each reader, see Convert PDF Files to Raster Images, on page 98 . By default, the basic reader (<code>pdfsr</code>) is used to convert PDF documents.
-c KVCFG_SETTEXTROTATE	This option specifies that rotated text should be displayed at the bottom of a page on which it appears. By default, rotated text in a file is displayed in its original position, at the original font size, and at 0 degrees rotation. The text is not rotated in the output because text rotation is not supported by HTML. See Convert Rotated Text, on page 104 for more information. Currently, this configuration option applies only to PDF files.
-c KVCFG_DELSOFTYPHEN	This option specifies that soft hyphens in PDF files are deleted from the converted output. See Control Hyphenation, on page 105 .
-pdfauto	This option specifies that PDF files are output in a logical reading order. The PDF reader determines the paragraph direction (left-to-right or right-to-left) for each PDF page, and then sets the direction accordingly. See Convert PDF Files to a Logical Reading Order, on page 99 .
-pdfltr	This option specifies that PDF files are output in a logical reading order, and the paragraph direction is left to right. See Convert PDF Files to a Logical Reading Order, on page 99 .
-pdfrtl	This option specifies that PDF files are output in a logical reading order, and the paragraph direction is right to left. See Convert PDF Files to a Logical Reading Order, on page 99 .
-pdfraw	This option specifies that PDF files are output in an unstructured paragraph flow.

Options for `cnv2htmlloop`, continued

Option	Description
	This is the default. Set this flag if logical reading order is enabled, and you want to return to an unstructured paragraph flow. See Convert PDF Files to a Logical Reading Order , on page 99.

onfile

The `onfile` sample program converts a source document into a single, formatted HTML file.

To run `onfile`, type the following at the command line:

```
onfile inputfile outputfile
```

where:

inputfile is the full path and file name of the source document.

outputfile is the full path and file name of the HTML output file.

index

The `index` sample program produces minimal HTML output suitable for use with indexing engines. It converts a source document into a single, largely unformatted HTML file.

To run `index`, type the following at the command line:

```
index inputfile outputfile
```

where:

inputfile is the full path and file name of the source document.

outputfile is the full path and file name of the HTML output file.

io_samp

The `io_samp` sample program demonstrates how to create an input and an output stream by providing a simple wrapper around the ANSI C interface `fOpen()`, `fRead()`, `fSeek()`, `fTell()`, and `fClose()`. It converts a source document into a single, largely unformatted HTML file.

To run `io_samp`, type the following at the command line:

```
io_samp inputfile outputfile
```

where:

inputfile is the full path and file name of the source document.

outputfile is the full path and file name of the HTML output file.

htmlini

The `htmlini` sample program is used in conjunction with template files to produce HTML documents. For more information on template files, see [Explore Conversion Options with the Sample Programs, on page 39](#). Sample template files are in the directory `install\htmlexport\programs\ini`. You can use this sample program on Windows and UNIX platforms.

To run `htmlini`, type the following at the command line:

```
htmlini [options] inifile inputfile outputfile
```

where:

options is one or more of the options listed in [Options for htmlini, below](#).

inifile is the full path and file name of a template file.

inputfile is the full path and file name of the source document.

outputfile is the full path and file name of the first HTML output file.

The following options are available.

Options for htmlini

Option	Description
-c <i>css_</i> <i>filename</i>	This option writes Cascading Style Sheet (CSS) information to an external file. See Use Style Sheets with htmlini, on the next page .
-x <i>xmlconfig_</i> <i>path</i>	This option converts an XML file by using customized element extraction settings defined in the <code>kvxconfig.ini</code> file. If you do not enter the full path to the template file, the program looks for the file in the current working directory (<code>install\OS\bin</code> , where <code>install</code> is the path name of the Export installation directory and <code>OS</code> is the name of the operating system). See Convert XML Files, on page 111 .
-hl <i>term</i> <i>term term</i>	This option specifies the text string or strings that are found and highlighted in the HTML output. You can specify a maximum of three terms. See Search and Highlight Terms, on page 91 .
-hc <i>charset</i>	This option specifies the character set of the highlighted search terms in the HTML output.
-hi	This option specifies that the text search is case insensitive. You can use this option only when the target character set for the highlighted search term is <code>KVCS_1252</code> .
-rm	This option converts text and graphics that were deleted from a document with revision tracking enabled, and includes revision information in the HTML output.

Options for `htmlini`, continued

Option	Description
	See Include Revision Information, on page 92 . This option uses the following hard-coded defaults: <ul style="list-style-type: none">• the revision title includes the text string "inserted:" for <code><ins></code> tags and "deleted:" for <code></code> tags.• the revision title includes the reviewer name, date, and time.• defines two HTML styles used to highlight reviewers' edits.• creates a revision summary file.
<code>-bp</code>	This option prevents graphics from being converted and generates image tags with empty <code>src</code> attributes. This makes the conversion faster, and maintains the text flow of the original document, because placeholders are generated for the graphics.
<code>-oop</code>	This option runs the conversion out of process.
<code>-fl</code>	This option prints a list of converted files in the console.
<code>-pi</code> ButtonName	This option enables a toggle button in exported PDF documents that you can click to show or hide invisible text. ButtonName determines the name of the toggle button. See Toggle Invisible Text, on page 103 .
<code>-ov</code> OpacityValue	This option specifies the opacity of invisible text in exported PDF documents. OpacityValue is an integer from 0 (invisible) to 100 (fully visible). The default is 0. See Specify Opacity of Invisible Text, on page 103 .

If the HTML file is output to a directory other than `programs\tempout`, you must update the HTML markup so that the browser can find images used by the templates (such as backgrounds or corporate logos) and the style sheet. The markup contains relative references to the image files (`..\images`).

Use Style Sheets with `htmlini`

The `htmlini` sample program has an option that allows Cascading Style Sheet (CSS) information to be written to an external file. This makes the HTML output document significantly smaller and enables you to use the same style sheet for many conversions. If the style sheet does not exist or if it is empty, it is created.

To write CSS information to an external file:

1. In the template file, set `eStyleSheetType` to `CSS_TOFILE`. This specifies that the formatting data is stored in a CSS file.
2. In the template file, use the `$STYLESHEET` token to specify the URL of the style sheet in the HTML output. The external CSS file is referenced in the output HTML by a `LINK` statement of the form:

```
<LINK rel="STYLESHEET" href="CSS_file" type="text/css">
```

3. At the command prompt, type:

```
htmlini -c stylesheetname infile inputfile outputfile
```

where *stylesheetname* is the path and file name of the CSS file.

callback

The `callback` sample program demonstrates how you can control the conversion to generate specialized output while it is in progress. The program employs developer-defined callbacks and memory management functions during conversion.

To run `callback`, type the following at the command line:

```
callback inputfile outputfile
```

where:

inputfile is the full path and file name of the source document.

outputfile is the full path and file name of the first HTML output file.

jvtree_demo

The C program `jvtree_demo` creates a frame-based HTML stream which uses the `JVTree.jar` to display the table of contents.

To compile the `jvtree_demo` sample program, use the makefile (`kvhtml.mak`) in the directory `install\html\export\programs\jvtree_demo`, where `install` is the path name of the Export installation directory.

To run `jvtree_demo`, type the following at the command line:

```
jvtree inputfile outputfile.htm
```

where:

inputfile is the full path and file name of the source document.

outputfile.htm is the full path and file name of the first HTML output file.

NOTE: This program requires the Java Runtime Environment (JRE) 1.3 or higher.

The Java applet, `JVTree.jar`, must be in the same directory as the HTML Export libraries and the output HTML files.

Set the `CLASSPATH` environment variable to include the location of the `\lib` directory and `lib\tools.jar` file for the JDK installed on the machine. Multiple path entries should be separated by semicolons. You must also include the current directory in the search path by using "." in the new setting.

JVTree

The `JVTree` sample program employs user callbacks and a Java applet to produce an expandable tree view of the table of contents in a frame-based HTML output file.

To compile the `JVTree` sample program, use the makefile (`kvhtml.mak`) in the directory `install\html\export\programs\jvtree`, where `install` is the path name of the Export installation directory.

To run `JVTree`, type the following at the command line:

```
jvtree inputfile outputfile.htm
```

where:

inputfile is the full path and file name of the source document.

outputfile.htm is the full path and file name of the first HTML output file.

NOTE: This program requires the Java Runtime Environment (JRE) 1.5 or higher.

The Java applet, `JVTree.jar`, must be in the same directory as the HTML Export libraries and the output HTML files.

Set the `CLASSPATH` environment variable to include the location of the `\lib` directory and `lib\tools.jar` file for the JDK installed on the machine. Separate multiple path entries with semicolons. You must also include the current directory in the search path by using `."` in the new setting.

kvhtmlexport

A sample program that you can use to try out the KeyView [HTML Export Reference Implementation](#).

This sample program is available in the directory `PLATFORM\bin`, where `PLATFORM` is the name of the platform on which you are running KeyView.

You can run the program as follows:

```
kvhtmlexport [options] inputfile outputfile
```

where:

- *options* are described in the following table.
- *inputfile* is the path and file name of the source document.
- *outputfile* is the path and file name of the HTML output file.

Option	Description
--fullscreen	When you set this option, presentations are displayed in "full screen" view, one slide at a time. You can navigate between slides using the arrow keys on your keyboard or the scroll wheel on your mouse. By default, presentations are displayed in "list" view, with slides arranged in a vertical column one after another.

Export Demo

Export Demo is a Visual Basic program that provides an easy-to-use graphical user interface to the Export technology. It allows you to select files, convert them to HTML, and view the result in a browser object. The output options that control the look of the output files are predefined in Export Demo and cannot be changed in the user interface.

Export Demo accesses the Export functionality by returning to the operating system and running a C program named `cnv2html`. To adapt the sample program to your needs, modify the GUI by using Visual Basic, and modify the `cnv2html` program by using C. For more information on the C program, see [htmlini](#), on page 129.

The source code for the program is in the directory `install\htmlexport\programs\ExportDemo`, where `install` is the path name of the Export installation directory. Export Demo is for Windows only.

See [Use the Export Demo Program](#), on page 42 for more information.

Template Wizard

The Template Wizard is a Visual Basic program that provides an easy-to-use graphical user interface to the Export technology. It is an example of how to use most of the properties, methods, and events available in the COM Automation Server. See [COM Interface Methods and Events](#), on page 279 and [COM Interface Properties](#), on page 284 for more information on the properties and methods.

The Template Wizard converts documents based on the predefined templates. Several templates are supplied with HTML Export, and they can be customized to suit your needs. See [Explore Conversion Options with the Sample Programs](#), on page 39 for details on the template files.

NOTE: The Template Wizard requires a COM server to be registered. See [Use the COM Implementation of the API](#), on page 49.

You can use the Template Wizard to modify existing template files to create your own customized files, and to convert documents to HTML. However, the Template Wizard does not allow you to modify all structures in the template files. To control some display options, you might have to modify the template files directly or use the API.

Convert Documents to HTML by Using the Template Wizard

To convert a document to HTML

1. Launch HTML Export Template Wizard.

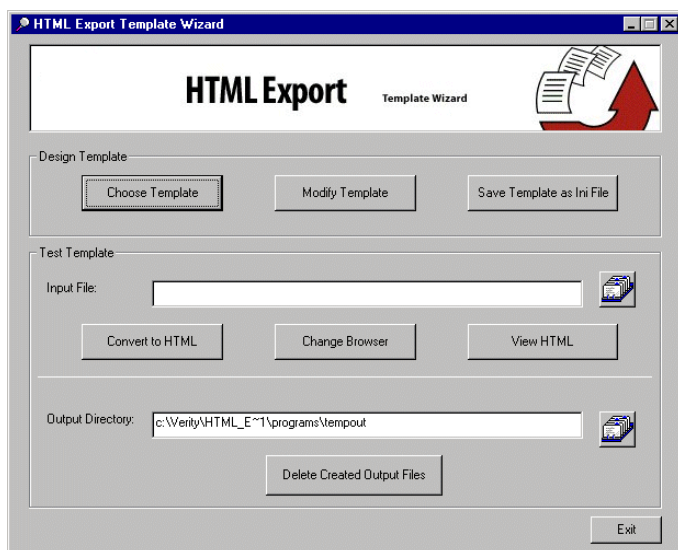

2. Click **Choose Template**.
3. Select one of the templates listed in the Choose Template dialog box, or click the browse button to select another template file. The template files are located in the `programs\ini` directory. Click **OK**.
4. Select an input file by using the browse button next to the **Input File** field.
5. Click **Convert to HTML** to produce an HTML file of the source document.
6. Click **View HTML** to open the converted file in your browser. To specify which browser is used to view the converted HTML files, click **Change Browser**.

When you change the default browser, the location of the browser's executable file is written to a file named `browser.wiz`. If the browser is not changed, the default browser is the Visual Basic web browser object\OCX.

Change the Output Directory

By default, the output file is stored in the `programs\tempout` directory. To change this directory, click the browse button next to the **Output Directory** field and select a new directory.

If you change the default output directory, you must make the following modifications to the templates:

1. Update the HTML markup so that any images used by the templates (such as backgrounds or corporate logos) are found by the browser. The markup contains relative references to the image files (`..\images`).

2. Update the templates so that the Java applet (JVTree.jar) is found.

NOTE: JVTree.jar is used to display an expandable table of contents. [JVTree](#), on page 132 for more information on JVTree.jar.

To delete the HTML and image files created in the output directory, click **Delete Created Output Files**.

Modify a Template in the Wizard

The Template Wizard provides limited control over the templates. You might wish to modify the template files directly in a text editor to provide maximum customization of the converted HTML. See [Explore Conversion Options with the Sample Programs](#), on page 39.

To modify the default options specified in the Wizard

1. Click **Modify Template**.
2. Modify the properties in the **Options** dialog box. The template parameters associated with each option in the **Options** dialog box are listed below and are described in [HTML Export API Structures](#), on page 215.

Wizard field	Template parameter
All Formats tab	
Use text color in the original document	bUseDocumentColors
Use font information in the original document	bUseDocumentFontInfo
Use font face attributes in the document	bSupportFontFace
Set font size relative to base font size	bDisplayRelativeFontSize
Support user font size mapping	bSupportUserFontSizeMapping
User Font Size Map	FontSizeMap
Emit <td>\$nbsp;</td> for empty cells	bNbspEmptyCells
Support "col=x" HTML parameter	bSupportRFC1942_cols
Convert tabs to tables	bTabsToTables
Table Border	SATableBorder
Table Cell Width	nTableBorderWidth
Output Language ID	OutputLanguageID
Style Sheet Type	eStyleSheetType
Replace Character	cReplaceChar
Redact Character	cRedact

Wizard field	Template parameter
Word Processing tab	
Minimum length of paragraph	minParaLen
Maximum length of paragraph	maxParaLen
Minimum font size	fontSizeMin
Maximum font size	fontSizeMax
Required space before paragraph	mSpaceBefore
Required space after paragraph	mSpaceAfter
Must be bold	bMustBeBold
Must be italic	bMustBeItalic
Must be underlined	bMustBeUnderlined
Can be non-zero indent	bNonZeroIndent
Cannot contain tab	bNoTabs
Cannot contain two or more spaces	bNoMultiSpaces
Heading Create Options	headingCreateType
Force source character set	bForceSrcCharSet
Source Character Set	eSrcCharSet
Force output character set	bForceOutputCharSet
Output Character Set	OutputCharSet
Spreadsheet tab	
Support column width	bSupportColumnWidth
Generate column headings	bSupportColumnHeadings
Generate row headings	bSupportRowHeadings
Support cell span	bSupportCellSpan
Support row span	bSupportRowSpan
Remove empty columns	bRemoveEmptyColumns
Enable empty rows	bEnableEmptyRows
Specify maximum rows per table	nRowsBeforeSplit
Presentation/Image tab	

Wizard field	Template parameter
Output any raster images to the following format	OutputRasterGraphicType
Output any vector images to the following format	OutputVectorGraphicType
Resolution of output image in x direction	cxVectorToRasterXRes
Resolution of output image in y direction	cyVectorToRasterYRes
Output presentation graphics as text and images	bRasterizeFiles
No pictures	bNoPictures
Compression quality	nCompressionQuality
Paragraph Styles tab	
Style Name	StyleName
MarkUpStart	MarkUpStart
MarkUpEnd	MarkUpEnd
Heading 1	Flags=KVSTYLE_HEADING1 (see Flags for Defining Styles, on page 89)
Heading 2	Flags=KVSTYLE_HEADING2 (see Flags for Defining Styles, on page 89)
Heading 3	Flags=KVSTYLE_HEADING3 (see Flags for Defining Styles, on page 89)
Heading 4	Flags=KVSTYLE_HEADING4 (see Flags for Defining Styles, on page 89)
Heading 5	Flags=KVSTYLE_HEADING5 (see Flags for Defining Styles, on page 89)
Heading 6	Flags=KVSTYLE_HEADING6 (see Flags for Defining Styles, on page 89)
PRE	Flags=KVSTYLE_PRE (see Flags for Defining Styles, on page 89)
Redact	Flags=KVSTYLE_REDACT (see Flags for Defining Styles, on page 89)
Order List	Flags=KVSTYLE_ORDERLIST (see Flags for Defining Styles, on page 89)
Unordered List	Flags=KVSTYLE_UNORDERLIST (see Flags for Defining Styles, on page 89)
Delete Content	Flags=KVSTYLE_DELETECONTENT (see Flags for Defining Styles, on page 89)

Wizard field	Template parameter
On Consecutive Paragraphs	Flags=ONCONSECUTIVEPARAGRAPHS (see Flags for Defining Styles, on page 89)

3. You can use the **Paragraph Styles** tab to map paragraph and character styles in any word processing document that contains styles (such as Microsoft Word, RTF, or Folio Flat File) to arbitrary markup.
4. To create a new template that preserves any modifications that have been made, click **Save Template as Ini File**.

comsamp

This Visual Basic program illustrates how to use the properties, methods, and events of the ActiveX controls from within Visual Basic. Before you can use this sample you must:

- Register an htmserv COM object. See the registration instructions in [Use the COM Implementation of the API, on page 49](#).
- If required, specify the location of the HTML Export binaries and the default directory containing source files.

More detailed information on properties, methods, and events is found in [COM Interface Methods and Events, on page 279](#) and [COM Interface Properties, on page 284](#).

htmlloop

The htmlloop sample program demonstrates how to use the COM interface from within a C++ application. Using the COM interface allows C++ developers to take advantage of out-of-process HTML conversion.

To run htmlloop, type the following command:

```
htmlloop install, infile, inputfile, outputfile.htm
```

where:

install is the directory where the Export libraries are installed.

infile is the full path and file name of a template file.

inputfile is the full path and file name of the source document.

outputfile.htm is the full path and file name of the HTML output file.

NOTE: You must separate the arguments with commas (,). You must **not** enclose directory names that contain spaces in quotation marks. This program does not indicate when the conversion has finished.

Part 3: C API Reference

This section provides detailed reference information for the C-language implementation of the File Extraction and Export APIs.

- [File Extraction API Functions](#)
- [File Extraction API Structures](#)
- [HTML Export API Functions](#)
- [HTML Export API Callback Functions](#)
- [HTML Export API Structures](#)
- [Enumerated Types](#)

Chapter 6: File Extraction API

Functions

This section describes the functions in the File Extraction API. The File Extraction functions open a container file, and extract the container's subfiles so that the subfiles are exposed and available for conversion. Subfiles can be files within a Zip archive, messages in a mail store, attachments in a mail message, or OLE objects embedded in a compound document.

Each function appears as a function prototype followed by a description of its arguments, its return value, and a discussion of its use.

• KVGetExtractInterface()	140
• fpCloseFile()	141
• fpExtractSubFile()	142
• fpFreeStruct()	143
• fpGetMainFileInfo()	144
• fpGetSubFileInfo()	145
• fpGetSubFileMetaData()	147
• fpOpenFile()	149

KVGetExtractInterface()

This function is the entry point to obtain the file extraction functions. When `KVGetExtractInterface()` is called, it assigns the function pointers in the structure `KVExtractInterface` to the functions described in this section.

Syntax

```
int pascal KVGetExtractInterface (  
    void *pContext,  
    KVExtractInterface pIextract);
```

Arguments

- `pContext` A pointer returned from `fpInit()` or `fpInitWithLicenseData()`.
- `pIextract` A pointer to the [KVExtractInterface](#) structure, which contains function pointers that `KVGetExtractInterface()` assigns to all other file extraction functions.

Before you initialize the `KVExtractInterface` structure, use the macro `KVStructInit` to initialize the `KVStructHead` structure.

Returns

- If the call is successful, the return value is `KVERR_Success`.
- If the call is not successful, the return value is an error code.

Example

```
fpKVGetExtractInterface =  
(int (pascal *) ( void *, KVExtractInterface))myGetProcAddress(hKVExport,  
(char*)"KVGetExtractInterface");  
/*Initialize file extraction interface structure using KVStructInit*/  
KVStructInit(&extractInterface);  
/* Retrieve file extraction interface */  
error = (*fpKVGetExtractInterface)(pExport,&extractInterface)
```

fpCloseFile()

This function frees the memory allocated by [fpOpenFile\(\)](#) and closes the file.

Syntax

```
int (pascal *fpCloseFile) (void *pFile);
```

Arguments

`pFile` The identifier of the file. This is a file handle returned from `fpOpenFile()`.

Returns

- If the file is closed, the return value is `KVERR_Success`.
- If the file is not closed, the return value is an error code.

Example

```
extractInterface->fpCloseFile(pFile);  
pFile = NULL;
```

fpExtractSubFile()

This function extracts a subfile from a container file to a user-defined path or output stream. This call returns file format information when file is extracted to a path.

Syntax

```
int (pascal *fpExtractSubFile) (  
    void *pFile,  
    KVExtractSubFileArg extractArg,  
    KVSubFileExtractInfo *extractInfo);
```

Arguments

- | | |
|--------------------------|--|
| <code>pFile</code> | The identifier of the file. This is a file handle returned from fpOpenFile() . |
| <code>extractArg</code> | A pointer to the structure KVExtractSubFileArg , which defines the subfile to be extracted.

Before you initialize the KVExtractSubFileArg structure, use the macro KVStructInit to initialize the KVStructHead structure. |
| <code>extractInfo</code> | A pointer to the structure KVSubFileExtractInfo , which defines information about the extracted subfile. |

Returns

- If the subfile is extracted from the container file, the return value is [KVERR_Success](#).
- If the subfile is not extracted from the container file, the return value is an error code.

Discussion

- After the file is extracted, call [fpFreeStruct\(\)](#) to free the memory allocated by this function.
- If the subfile is embedded in the main file as a link and is stored externally, `extractInfo->infoFlag` is set to [KVSubFileExtractInfoFlag_External](#).

For example, the subfile might be an object that was embedded in a Word document by using "Link to File," or an attachment that is referenced in an MBX message. This type of subfile cannot be extracted. You must write code to access the subfile based on the path in the member `extractInfo->filePath` or `extractInfo->fileName`. See [KVSubFileExtractInfo](#), on page 162.

Example

```
KVSubFileExtractInfo  extractInfo = NULL;

KVStructInit(&extractArg);

extractArg.index = index;
extractArg.extractionFlag = KVExtractionFlag_CreateDir | KVExtractionFlag_Overwrite;
extractArg.filePath = subFileInfo->subFileName;

/*Extract this subfile*/
error=extractInterface->fpExtractSubFile(pFile,&extractArg,&extractInfo);
if ( error )
{
    extractInterface->fpFreeStruct(pFile,extractInfo);
    subFileInfo = NULL;
}
```

fpFreeStruct()

This function frees the memory allocated by `fpGetMainFileInfo()`, `fpGetSubFileInfo()`, `fpGetSubFileMetadata()`, and `fpExtractSubFile()`.

Syntax

```
int (pascal *fpFreeStruct) (
    void      *pFile,
    void      *obj);
```

Arguments

- `pFile` The identifier of the file. This is a file handle returned from [fpOpenFile\(\)](#).
- `obj` A pointer to the result object returned by `fpGetMainFileInfo()`, `fpGetSubFileInfo()`, `fpGetSubFileMetaData`, or `fpExtractSubFile()`.

Returns

- If the allocated memory is freed, the return value is `KVERR_Success`.
- Otherwise, the return value is an error code.

Example

The example below frees the memory allocated by `fpGetSubFileInfo()`:

```
if ( subFileInfo )
{
    extractInterface->fpFreeStruct(pFile,subFileInfo);
    subFileInfo = NULL;
}
```

fpGetMainFileInfo()

This function determines whether a file is a container file—that is, whether it contains subfiles—and should be extracted further.

Syntax

```
int (pascal *fpGetMainFileInfo) (
    void          *pFile,
    KVMainFileInfo *fileInfo);
```

Arguments

- `pFile` The identifier of the file. This is a file handle returned from [fpOpenFile\(\)](#).
- `fileInfo` A pointer to the structure [KVMainFileInfo](#). This structure contains information about the file.

Returns

- If the file information is retrieved, the return value is `KVERR_Success`.
- If the file information is not retrieved, the return value is an error code.

Discussion

- After the file information is retrieved, call [fpFreeStruct\(\)](#) to free the memory allocated by this function.
- If the file is a container (`fileInfo->numSubFiles` is non-zero), call [fpGetSubFileInfo\(\)](#) and [fpExtractSubFile\(\)](#) for each subfile.
- If the file is not a container (`fileInfo->numSubFiles` is 0) and contains text (`fileInfo->infoFlag` is set to `KVMainFileInfoFlag_HasContent`), pass the file directly to the conversion functions.

Example

```
KVMainFileInfo  fileInfo  = NULL;
if( (error=extractInterface->fpGetMainFileInfo(pFile,&fileInfo))
{
    /* Free result object allocated in fileInfo */
    extractInterface->fpFreeStruct(pFile,fileInfo);
    fileInfo = NULL;
}
```

fpGetSubFileInfo()

This function gets information about a subfile in a container file.

Syntax

```
int (pascal *fpGetSubFileInfo) (
    void          *pFile,
    int           index,
    KVSubFileInfo *subFileInfo);
```

Arguments

- `pFile` The identifier of the main file. This is a file handle returned from [fpOpenFile\(\)](#).
- `index` The index number of the subfile for which to retrieve information.
- `subFileInfo` A pointer to the [KVSubFileInfo](#) structure, which defines information about the subfile.

Returns

- If the file information is retrieved, the return value is `KVERR_Success`.
- If the file information is not retrieved, the return value is an error code.

Discussion

- After the subfile information is retrieved, call [fpFreeStruct\(\)](#) to free the memory allocated by this function.
- If the root node is *not* enabled, the first subfile is index 0. If the root node is enabled, the first subfile is index 1. The root node is required to recreate a file's hierarchy. See [Create a Root Node, on page 59](#).
- The members `subFileInfo->parentIndex` and `subFileInfo->childArray` enable you to recreate a file's hierarchy. Because `childArray` retrieves only the first-level children in the subfile, you must call `fpGetSubFileInfo()` repeatedly until information for the leaf-node children is extracted. See [Recreate a File's Hierarchy, on page 58](#).
- If the subfile is embedded in the main file as a link and is stored externally, `subFileInfo->infoFlag` is set to `KVSubFileInfoFlag_External`. For example, the subfile might be an object that was embedded in a Word document by using "Link to File," or an attachment that is referenced in an MBX message. This type of subfile cannot be extracted. You must write code to access the subfile based on the path in the member `subFileInfo->subFileName`. See [KVSubFileInfo, on page 163](#).
- The `KVSubFileInfoFlag_External` flag is not set for an OLE object that is embedded as a link in a Microsoft PowerPoint file. KeyView can detect linked objects in a Microsoft PowerPoint file only when the object is extracted. See [fpExtractSubFile\(\), on page 142](#).

Example

```
KVSubFileInfo    subFileInfo = NULL;
for ( index = 0; index < fileInfo->numSubFiles; index++)
{
    error=extractInterface->fpGetSubFileInfo(pFile,index,&subFileInfo);
    if ( error )
    {
        extractInterface->fpFreeStruct(pFile,subFileInfo);
        subFileInfo = NULL;
    }
}
```

fpGetSubFileMetaData()

This function extracts metadata from mail stores, mail messages, and non-mail items. See [Extract Mail Metadata, on page 60](#).

Syntax

```
int (pascal *fpGetSubFileMetaData) (  
    void *pFile,  
    KVGetSubFileMetaArg metaArg,  
    KVSubFileMetaData *metaData);
```

Arguments

- pFile** The identifier of the file. This is a file handle returned from [fpOpenFile\(\)](#).
- metaArg** A pointer to the [KVGetSubFileMetaArg](#) structure, which defines metadata tags whose values are retrieved.
- Before you initialize the [KVGetSubFileMetaArg](#) structure, use the [KVStructInit](#) macro to initialize the [KVStructHead](#) structure.
- metaData** A pointer to the [KVSubFileMetaData](#) structure, which contains the retrieved metadata values.

Returns

- If the metadata is retrieved, the return value is `KVERR_Success`.
- If the metadata is not retrieved, the return value is an error code.

Discussion

- KeyView can extract a predefined set of common subfile metadata fields for all mail formats, and can extract all metadata from EML, MBX, MIME, NSF, ICS, and DXL files. To extract the common metadata fields, pass in 0 for `metaArg->metaNameCount`, and NULL for `metaArg->metaNameArray`. To extract all metadata, pass in -1 for `metaArg->metaNameCount` and NULL for `metaArg->metaNameArray`. For more information, see [Extract Mail Metadata, on page 60](#).
- After the metadata is retrieved, call [fpFreeStruct\(\)](#) to free the memory allocated by this function.

- If a field is repeated in an EML or MBX mail header, the values in each instance of the field are concatenated and returned as one field. The values are separated by five pound signs (#####) as a delimiter.

Example

```
KVSubFileMetaData metaData = NULL;

KVStructInit(&metaArg);

/* retrieve all the default metadata elements */
metaArg.metaNameCount = 0;
metaArg.metaNameArray = NULL;
metaArg.index = Index;

error = extractInterface->fpGetSubFileMetaData(pFile,&metaArg,&metaData);
...

extractInterface->fpFreeStruct(pFile,metaData);
metaData = NULL;

/* retrieve specific metadata fields */
KVMetaName pName[2];
KVMetaNameRec names[2];

names[0].type = KVMetaNameType_Integer;
names[0].name.iname = KVPR_SUBJECT;

names[1].type = KVMetaNameType_Integer;
names[1].name.iname = KVPR_DISPLAY_TO;

pName[0] = &names[0];
pName[1] = &names[1];

metaArg.metaNameCount = 2;
metaArg.metaNameArray = pName;
metaArg.index = Index;

error = extractInterface->fpGetSubFileMetaData (pFile,&metaArg,&metaData);
...
extractInterface->fpFreeStruct(pFile,metaData);
metaData = NULL;
```

fpOpenFile()

This function opens a file to make the file accessible for subfile extraction or conversion.

Syntax

```
int (pascal *fpOpenFile) (  
    void *pContext,  
    KVOpenFileArg openArg,  
    void **pFile);
```

Arguments

pContext A pointer returned from `fpInit()` or `fpInitWithLicenseData()`.

openArg A pointer to the [KVOpenFileArg](#) structure. This structure defines the input parameters necessary to open a file for extraction, such as credentials, and the default extraction directory.

Before you initialize the `KVOpenFileArg` structure, use the macro `KVStructInit` to initialize the `KVStructHead` structure.

pFile A handle for the opened file. This handle is used in subsequent file extraction calls to identify the source file.

Returns

- If the file is opened, the return value is `KVERR_Success`.
- If the file is not opened, the return value is an error code and `pFile` is `NULL`.

Discussion

Call [fpCloseFile\(\)](#) to free the memory allocated by this function.

Example

```
KVOpenFileArgRec    openArg;  
  
/*Initialize the structure using KVStructInit*/  
KVStructInit(&openArg);
```

```
openArg.extractDir = destDir;
openArg.filePath   = srcFile;

/*Open the main file */
if ( (error = extractInterface->fpOpenFile(pExport,&openArg,&pFile)))
{
    extractInterface->fpCloseFile(pFile);
    pFile = NULL;
}
```

Chapter 7: File Extraction API Structures

This section provides information on the structures used by the File Extraction API. These structures define the input and output parameters required to extract subfiles from a container file, and are defined in `kvextract.h`.

- [KVCredential](#) 151
- [KVCredentialComponent](#) 152
- [KVExtractInterface](#) 152
- [KVExtractSubFileArg](#) 153
- [KVGetSubFileMetaArg](#) 156
- [KVMainFileInfo](#) 157
- [KVMetadataElem](#) 158
- [KVMetaName](#) 159
- [KVOpenFileArg](#) 160
- [KVOutputStream](#) 161
- [KVSubFileExtractInfo](#) 162
- [KVSubFileInfo](#) 163
- [KVSubFileMetaData](#) 166

KVCredential

This structure contains a count of the number of credential elements, and a pointer to the first element of the array of individual elements. The structure is initialized by calling [fpOpenFile\(\)](#), and is defined in `kvextract.h`.

```
typedef struct tag_KVCredential
{
    int                itemCount;
    KVCredentialComponent *items;
}
KVCredentialRec, *KVCredential;
```

Member Descriptions

`itemCount` The number of credentials defined for this file.

items A pointer to the [KVCredentialComponent](#) structure. This structure contains the individual credential elements used to open a protected file.

KVCredentialComponent

This structure contains the value of a credential item. The structure is defined in `kvextract.h`.

```
typedef struct tag_KVCredentialComponent
{
    KVCredKeyType    keytype;
    union
    {
        void          *pkey;
        char           *skey;
        unsigned int   ikey;
    }
    keyobj;
}
KVCredentialComponentRec, *KVCredentialComponent;
```

Member Descriptions

keytype The type of credential (such as a user name or password). The types are defined by the [KVCredKeyType](#) enumerated type.

pkey A pointer to a structure defining credentials. Reserved for future use.

skey A pointer to a string credential key.

ikey An integer credential key.

KVExtractInterface

The members of this structure are pointers to the file extraction functions described in [File Extraction API Functions, on page 140](#). When you call the [KVGetExtractInterface\(\)](#) function, this structure assigns pointers to the functions. The structure is defined in `kvextract.h`.

```
typedef struct tag_KVExtractInterface
{
    KVStructHeader;
    int (pascal *fpOpenFile) (void *pContext, KVOpenFileArg openArg, void
**pFileHandle);
    int (pascal *fpCloseFile) (void *pFileHandle);
    int (pascal *fpGetMainFileInfo) (void *pFile, KVMainFileInfo *MainFileInfo);
}
```



```
    int (pascal *fpGetSubFileInfo) (void *pFile, int index, KVSubFileInfo
*subFileInfo);
    int (pascal *fpGetSubFileMetaData) (void *pFile, KVGetSubFileMetaArg metaArg,
KVSubFileMetaData *metaData);
    int (pascal *fpExtractSubFile) (void *pFile, KVExtractSubFileArg extractArg,
KVSubFileExtractInfo *extractInfo);
    int (pascal *fpFreeStruct) (void *pFile, void *obj);
}
KVExtractInterfaceRec, *KVExtractInterface;
```

Member Descriptions

The member functions are described in [File Extraction API Functions, on page 140](#).

Discussion

Before you initialize a File Extraction structure, use the `KVStructInit` macro to initialize the `KVStructHead` structure. This process sets the revision number of the File Extraction API and supports binary compatibility with future releases.

KVExtractSubFileArg

This structure defines the input parameters required to extract a subfile. See [fpExtractSubFile\(\), on page 142](#). The structure is defined in `kvxtract.h`.

```
typedef struct tag_KVExtractSubFileArg
{
    KVStructHeader;
    int          index;
    KVCharSet    srcCharset;
    KVCharSet    trgCharset;
    int          isMSBLSB;
    DWORD        extractionFlag;
    char         *filePath;
    char         *extractDir;
    KVOutputStream *stream;
}
KVExtractSubFileArgRec, *KVExtractSubFileArg;
```

Member Descriptions

`KVStructHeader` The KeyView version of the structure. See [KVStructHead, on page 224](#).

<code>index</code>	The index number of the subfile to be extracted.
<code>srcCharset</code>	Specifies the source character set of the subfile when the file format's reader cannot determine the character set. The character sets are enumerated in <code>KVCharset</code> in <code>kvcharset.h</code> . See Discussion, on the next page .
<code>trgCharset</code>	If the file type is <code>KVFileType_Main</code> , this is the target character set of the extracted file. Otherwise, this is ignored. The character sets are enumerated in <code>KVCharset</code> in <code>kvcharset.h</code> . See Discussion, on the next page .
<code>isMSBLSB</code>	This flag indicates whether the byte order for Unicode text is Big Endian (MSBLSB) or Little Endian (LSBMSB).
<code>extractionFlag</code>	<p>A bitwise flag that defines additional parameters for file extraction. The following flags are available:</p> <ul style="list-style-type: none">• <code>KVExtractionFlag_CreateDir</code><p>This flag indicates whether the directory structure of a subfile should be created. If you set this flag, the path defined in <code>filePath</code> is created if it does not already exist. If you do not set this flag, the path is not created, and the function returns <code>FALSE</code>.</p>• <code>KVExtractionFlag_Overwrite</code><p>If you set this flag, and the file being extracted has the same name as a file in the target path, the file in the target path is overwritten without warning. If you do not set this flag, and a subfile has the same name as a file in the target path, the error <code>KVError_OutputFileExists</code> is generated.</p>• <code>KVExtractionFlag_ExcludeMailHeader</code><p>If you set this flag, header information (To, From, Sent, and so on) in a mail file is not included in the extracted data. If you do not set this flag, the extracted data contains header information and the message's body text. See Exclude Metadata from the Extracted Text File, on page 67.</p>• <code>KVExtractionFlag_GetFormattedBody</code><p>If you set this flag, the formatted version of the message body (HTML or RTF) is extracted from mail files when possible. If neither an HTML nor RTF version of the message body exists in the mail file, it is extracted as plain text. If you do not set this flag, the message body is extracted as plain text when possible.</p><div data-bbox="521 1549 1383 1738" style="border-left: 2px solid blue; padding-left: 10px;"><p>NOTE: When an HTML or RTF message body is extracted, the message's mail headers (such as "From," "To," and "Subject,") are extracted, saved in the same format, and added to the beginning of the subfile. This applies to PST (MAPI-based reader), MSG, and NSF files only.</p></div>• <code>KVExtractionFlag_SaveAsMSG</code><p>If you set this flag, the mail message is extracted as an MSG file, including all of its attachments. If you do not set this flag, the mail message is</p>

extracted as text. This applies to PST files on Windows only.

NOTE: In file mode, when the application sets this flag in `fpExtractSubFile()`, it must also check the `KVSubFileExtractInfo` structure's `filePath` parameter to verify the file name used for extraction.

- `KVExtractionFlag_SanitizeAbsolutePaths`

If you set this flag, KeyView ensures that the file is extracted to a location within the extract directory (`extractDir`), even if an absolute path is supplied using `filePath`. When KeyView sanitizes a path and the resulting directory does not exist, extraction fails unless you instruct KeyView to create the directory, so you might also want to set the flag `KVExtractionFlag_CreateDir`. For more information, see [Sanitize Absolute Paths, on page 57](#).

<code>filePath</code>	A pointer to the suggested path or file name to which the subfile is extracted. This can be a file name, partial path, or full path. You can use this in conjunction with <code>extractDir</code> to create the full output path. See Discussion, below .
<code>extractDir</code>	A pointer to the directory to which subfiles are extracted. This directory must exist. If you set this flag, the path specified in <code>KVOpenFileArg->extractDir</code> is ignored. You can use this in conjunction with <code>filePath</code> to create the full output path.
<code>stream</code>	A pointer to an output stream defined by KVOutputStream . See Discussion, below .

Discussion

- If the document character set is detected and is also specified in `srcCharset`, the detected character set is overridden by the specified character set. If the source character set is *not* detected and is *not* specified, character set conversion does not occur. The [Document Readers, on page 392](#) section lists the formats for which the source character set can be determined.
- The `KVSubFileExtractInfoFlag_CharsetConverted` flag in the `KVSubFileExtractInfo` structure indicates whether the character set of the subfile was converted during extraction.
- The following applies when the output is to a file:
 - If `filePath` is a valid absolute path, the file is extracted to the specified path and `extractDir` is ignored. However, if you have set the flag `KVExtractionFlag_SanitizeAbsolutePaths` the output path is modified to ensure it is within the `extractDir`. For more information, see [Sanitize Absolute Paths, on page 57](#).
 - If `filePath` is a file name or partial path, the target directory specified in either `KVExtractSubFileArg->extractDir` or `KVOpenFileArg->extractDir` is used to create the full path. See [KVOpenFileArg, on page 160](#).
 - If `filePath` is a full path or partial path, and `createDir` is `TRUE`, the directory is created if it does not already exist.

- If `filePath` is not specified, a default name and the target directory specified in either `KVExtractSubFileArg->extractDir` or `KVOpenFileArg->extractDir` are used to create a full path.
- If both `filePath` and `extractDir` are not specified or are invalid, an error is returned.
- If `filePath` is valid, but `extractDir` is not valid, an error is returned.
- The following applies when the output is to a stream:
 - Set `filePath` and `extractDir` to `NULL`.
 - The file format (`docInfo`) and extraction file path (`filePath`) are not returned in [KVSubFileExtractInfo](#).
 - The `KVExtractionFlag_CreateDir` and `KVExtractionFlag_Overwrite` flags are ignored.

KVGetSubFileMetaArg

This structure defines the metadata tags whose values are retrieved by [fpGetSubFileMetaData\(\)](#). This structure is defined in `kvextract.h`.

```
typedef struct tag_KVGetSubFileMetaArg
{
    KVStructHeader;
    int          index;
    int          metaNameCount;
    KVMetaName   *metaNameArray;
    KVCharSet    srcCharset;
    KVCharSet    trgCharset;
    int          isMSBLSB;
}
KVGetSubFileMetaArgRec, *KVGetSubFileMetaArg;
```

Member Descriptions

<code>KVStructHeader</code>	The KeyView version of the structure. See KVStructHead, on page 224 .
<code>index</code>	The index number of the subfile for which metadata is extracted.
<code>metaNameCount</code>	The number of metadata fields to be extracted.
<code>metaNameArray</code>	A pointer to the KVMetaName structure that contains an array of metadata tags whose values are retrieved.
<code>srcCharset</code>	Specifies the source character set of the metadata when the format's reader cannot determine the character set. The character sets are enumerated in <code>KVCharSet</code> in <code>kvcharset.h</code> . See Discussion, on the next page .
<code>trgCharset</code>	The target character set of the extracted metadata.

The character sets are enumerated in KVCharSet in kvcharset.h.

isMSBLSB This flag indicates whether the byte order for Unicode text is Big Endian (MSBLSB) or Little Endian (LSBMSB).

Discussion

- If the character set is detected and is also specified in srcCharset, the detected character set is overridden by the specified character set. If the source character set is *not* detected and is *not* specified, character set conversion does not occur. The section [Document Readers, on page 392](#) lists the formats for which the source character set can be determined.
- KeyView can extract a predefined set of common subfile metadata fields for all mail formats, and can extract all metadata from EML, MBX, MIME, NSF, ICS, and DXL files. To extract the common metadata fields, pass in 0 for metaArg->metaNameCount, and NULL for metaArg->metaNameArray. To extract all metadata, pass in -1 for metaArg->metaNameCount and NULL for metaArg->metaNameArray. For more information, see [Extract Mail Metadata, on page 60](#).

KVMainFileInfo

This structure contains information about a main file that is open for extraction. It is initialized by calling [fpGetMainFileInfo\(\)](#). This structure is defined in kvextract.h.

```
typedef struct tag_KVMainFileInfo
{
    KVStructHeader;
    int          numSubFiles;
    ADDOCINFO   docInfo;
    KVCharSet   charset;
    int         isMSBLSB;
    unsigned long infoFlag;
}
KVMainFileInfoRec, *KVMainFileInfo;
```

Member Descriptions

KVStructHeader The KeyView version of the structure. See [KVStructHead, on page 224](#).

numSubFiles The number of subfiles in the main file.

docInfo The file's major format (such as Microsoft Word or Corel Presentation), as defined by the structure ADDOCINFO. See [ADDOCCINFO, on page 216](#).

charset The character set of the main file.

isMSBLSB This flag indicates whether the byte order for Unicode text is Big Endian

MSBLSB) or Little Endian (LSBMSB).

infoFlag

A bitwise flag that provides additional information about the main file. The following flag is available:

KVMainInfoFlag_HasContent—The main file contains text that can be converted. Below are some examples of how this flag is used:

- For an MSG file without attachments, numSubFiles is 1 (message body text), and this flag is FALSE because the MSG file itself does not contain text.
- For a Zip file with three files, numSubFiles is 3, and this flag is FALSE because a Zip file does not contain text.
- For a Microsoft Word file with an embedded OLE object, numSubFiles is 1 (OLE object), and this flag is TRUE (Word file contains text to be converted).

Discussion

- If numSubFiles is non-zero, get information on the subfile by calling [fpGetSubFileInfo\(\)](#), and then extract the subfiles by using [fpExtractSubFile\(\)](#).
- If numSubFiles is 0, the file does not contain subfiles and does not need to be extracted further. If the KVMainInfoFlag_HasContent flag is set, the file contains body text and can be passed directly to the conversion functions. See [HTML Export API Functions, on page 167](#).
- If openFlag is set to **KVOpenFileFlag_CreateRootNode** in the call to [fpOpenFile\(\)](#), numSubFiles also includes the root object (index 0) which is created by KeyView for reconstructing the file's hierarchy. See [KVOpenFileArg, on page 160](#).

KVMetadataElem

This structure contains metadata field values extracted from a mail file. This structure is defined in `kvtypes.h`.

```
typedef struct tag_KVMetadataElem
{
    int          isValid;
    int          dataID;
    KVMetadataType  dataType;
    char*        strType;
    void*        data;
    int          dataSize;
}
KVMetadataElem;
```

Member Descriptions

<code>isValid</code>	Specifies whether the metadata returned from the API is valid data.
<code>dataID</code>	The integer name of the extracted metadata field.
<code>dataType</code>	The data type of the metadata field. The types are defined in KVMetadataType in <code>kvtypes.h</code> .
<code>strType</code>	A pointer to the string name of the metadata field.
<code>data</code>	The contents of the metadata field. If the type member is <code>KVMetadata_Int4</code> or <code>KVMetadata_Bool</code> , this member contains the actual value. Otherwise, this member is a pointer to the actual value. <code>KVMetadata_DateTime</code> points to an 8-byte value. <code>KVMetadata_String</code> and <code>KVMetadata_Unicode</code> point to the beginning of the string that contains the text. The strings are NULL terminated. <code>KVMetadata_Binary</code> points to the first element of a byte array.
<code>dataSize</code>	The byte count of data when the type is <code>KVMetadata_Binary</code> , <code>KVMetadata_Unicode</code> , or <code>KVMetadata_String</code> .

KVMetaName

This structure defines the names of the metadata fields to be extracted from a mail file. This structure is defined in `kvextract.h`.

```
typedef struct tag_KVMetaName
{
    KVMetaNameType    type;
    union
    {
        void          *pname;
        int           iname;
        char          *sname;
    }name;
}
KVMetaNameRec, *KVMetaName;
```

Member Descriptions

<code>type</code>	The type of metadata name (such as integer or string). The types are defined by the KVMetaNameType enumerated type.
-------------------	---

NOTE: MAPI property names are of type integer.

pname A pointer to a structure defining the metadata fields to be retrieved.

iname The name of a metadata field of type integer.

sname A pointer to the name of a metadata field of type string.

Discussion

If you specify the MAPI tag name (for example, `PR_CONVERSATION_TOPIC`), you must include the `mapitags.h` and `mapidefs.h` Windows header files, in which `PR_CONVERSATION_TOPIC` is defined as `0x0070001e`.

KVOpenFileArg

This structure defines the input arguments necessary to open a file for extraction. It is initialized by calling [fpOpenFile\(\)](#). This structure is defined in `kvextract.h`.

```
typedef struct tag_KVOpenFileArg
{
    KVStructHeader;
    KVCredential    cred;
    KVInputStream  *stream;
    char            *filePath;
    char            *extractDir;
    DWORD          openFlag;
    DWORD          reserved;
    void           *pReserved;
}
KVOpenFileArgRec, *KVOpenFileArg;
```

Member Descriptions

KVStructHeader The KeyView version of the structure. See [KVStructHead](#), on page 224.

cred The credentials required to open a protected PST or NSF file. This is a pointer to the [KVCredential](#) structure. Your application can define multiple credentials to this member for multiple formats.

stream A pointer to the developer-assigned instance of `KVInputStream`. The `KVInputStream` structure defines the input stream that contains the source. See [KVInputStream](#), on page 216.

If you are using a file as input, this is `NULL`.

<code>filePath</code>	<p>A pointer to the full file path to the source file.</p> <p>If you are using a stream as input, this is <code>NULL</code>.</p>
<code>extractDir</code>	<p>A pointer to the default directory to which subfiles are extracted. This directory must exist.</p> <p>You can use this in conjunction with <code>KVExtractSubFileArg->filePath</code> to create the full output path. See KVExtractSubFileArg, on page 153.</p>
<code>openFlag</code>	<p>A bitwise flag that defines additional parameters for opening the file. The following flag is available:</p> <p><code>KVOpenFileFlag_CreateRootNode</code>—If you set this flag, KeyView creates a root object when extracting this file’s subfiles. This root node does not have a parent and is at the highest level of the file’s tree structure. It is used internally to provide a reference point from which all other child nodes are determined, and the file’s hierarchy is created.</p> <p>If you want to maintain the file’s hierarchy when you extract subfiles from a container, you must set this flag. See Recreate a File’s Hierarchy, on page 58 for more information.</p> <p>The root node has an index of zero. Although not all container formats require an artificial root node, the root is created for all container formats regardless of whether the file itself contains a root directory or file.</p>
<code>reserved</code>	<p>Reserved for future use. It must be <code>NULL</code>.</p>
<code>pReserved</code>	<p>Reserved for future use. It must be <code>NULL</code>.</p>

KVOutputStream

This structure defines an output stream for the extracted subfile. The structure is defined in `kvstream.h`.

```
typedef struct tag_OutputStream
{
    void *pOutputStreamPrivateData;
    BOOL (pascal *fpCreate)(struct tag_OutputStream *,TCHAR *);
    UINT (pascal *fpWrite) (struct tag_OutputStream *, BYTE *, UINT);
    BOOL (pascal *fpSeek) (struct tag_OutputStream *, long, int);
    long (pascal *fpTell) (struct tag_OutputStream *);
    BOOL (pascal *fpClose) (struct tag_OutputStream *);
}
KVOutputStream;
```

Member Descriptions

All member functions are equivalent to their counterparts in the ANSI standard library.

KVSubFileExtractInfo

This structure contains information about an extracted subfile. It is initialized by calling [fpExtractSubFile\(\)](#). This structure is defined in `kvextract.h`.

```
typedef struct tag_KVSubFileExtractInfo
{
    KVStructHeader;
    char          *filePath;
    char          *fileName;
    unsigned long  infoFlag;
    ADDOCINFO     docInfo;
}
KVSubFileExtractInfoRec, *KVSubFileExtractInfo;
```

Member Descriptions

- | | |
|-----------------------------|---|
| <code>KVStructHeader</code> | The KeyView version of the structure. See KVStructHead, on page 224 . |
| <code>filePath</code> | The full path to which the subfile was extracted.

If the subfile is embedded in the main file as a link, this is the external path to the subfile.

If you output the data to a stream, the extraction path is not returned. |
| <code>fileName</code> | The original path, file name, or path and file name of the subfile.

If the subfile is embedded in the main file as a link, this is the external path to the subfile. |
| <code>infoFlag</code> | A bitwise flag that provides additional information about the extracted subfile. The following flags are available: <ul style="list-style-type: none">• <code>KVSubFileExtractInfoFlag_NeedsExtraction</code>—The file might contain subfiles and should be extracted further.• <code>KVSubFileExtractInfoFlag_FileCreated</code>—The file was created on disk.• <code>KVSubFileExtractInfoFlag_CharsetConverted</code>—The subfile's character set was converted.• <code>KVSubFileExtractInfoFlag_External</code>—The subfile is embedded in the main file as a link and is stored externally. For example, the subfile might be an object that was embedded in a Word document using "Link to File," or an attachment that is referenced in an MBX message. This type of file cannot be extracted. You must write code to access the subfile based on the path in the member <code>filePath</code> or <code>fileName</code>.• <code>KVSubFileExtractInfoFlag_FolderCreated</code>—A folder was created. |

- `KVSubFileExtractInfoFlag_NonFormattedBodyExtracted`—Indicates that a plain text version of the message was extracted due to an error extracting the formatted version of the message.

`docInfo` The file's major format (such as Microsoft Word or Corel Presentation), as defined by the structure `ADDOCINFO`. See [ADDOCINFO](#), on page 216.

If you output the data to a stream, the file format is not returned.

KVSubFileInfo

This structure contains information about a subfile in a container file. It is initialized by calling [fpGetSubFileInfo\(\)](#). This structure is defined in `kvextract.h`.

```
typedef struct tag_KVSubFileInfo
{
    KVStructHeader;
    char          *subFileName;
    int           subFileType;
    long          subFileSize;
    unsigned long infoFlag;
    KVCharSet     charset;
    int           isMSBLSB;
    BYTE         fileTime[8];
    int           parentIndex;
    int           childCount;
    int           *childArray;
}
KVContainerSubFileInfoRec, *KVSubFileInfo;
```

Member Descriptions

`KVStructHeader` The KeyView version of the structure. See [KVStructHead](#), on page 224.

`subFileName` The path, file name, or path and file name of the subfile.
If the subfile is the body text of a mail file or is an embedded OLE object, KeyView provides a default file name. See [Default File Names for Extracted Subfiles](#), on page 76.

`subFileType` The subfile's position in the container file's hierarchy.

- `KVSubFileType_Main` The subfile is at the top level of the main file. This is the default subfile type. See [Discussion](#), on page 165.
- `KVSubFileType_Attachment` The subfile is an attachment in a file.
- `KVSubFileType_OLE` The subfile is an embedded OLE object in a compound document.

- `KVSubFileType_Folder` The subfile is a folder or the artificial root node (see [Create a Root Node, on page 59](#)).
- `KVSubFileType_UncategorisedImage` An embedded image that has not been categorized by the reader.
- `KVSubFileType_EmbeddedImage` An embedded image.
- `KVSubFileType_EmbeddedIcon` An icon used to represent an embedded file.
- `KVSubFileType_EmbeddedContent` An image used to represent content for an embedded file. This could be an preview image of the actual content, or another representation such as an icon.
- `KVSubFileType_EmbeddedPreview` A preview of an embedded file. This is usually an image that shows part of the embedded file.
- `KVSubFileType_XrML` The subfile contains the XrML that describes the RMS protection used on an RMS-encrypted main file.

NOTE: The classification of embedded images into images, icons, content, and previews is supported only for some Microsoft Office file formats (DOC, DOCX, XLSX, PPT, PPTX).

<code>subFileSize</code>	<p>The size of the subfile in bytes. This information might be useful if you do not want to extract very large files.</p> <p>This value is approximate and is the maximum size of the subfile. The subfile is usually smaller than this value when it is extracted.</p>
<code>infoFlag</code>	<p>A bitwise flag that provides additional information about the subfile. The following flags are available:</p> <ul style="list-style-type: none">• <code>KVSubFileInfoFlag_NeedsExtraction</code>—The subfile might contain subfiles. It must be extracted further to conclusively determine whether it contains subfiles.• <code>KVSubFileInfoFlag_Secure</code>—The subfile is secured and credentials (such as user name and password) are required to extract it. This flag applies to ZIP, RAR, and PDF files only.• <code>KVSubFileInfoFlag_SMIME</code>—The subfile is S/MIME-encrypted and credentials are required to extract it. This applies to .eml and .pst files only.• <code>KVSubFileInfoFlag_External</code>—The subfile is embedded in the main file as a link and is stored externally. For example, the subfile might be an object that was embedded in a Word document by using "Link to File," or an attachment that is referenced in an MBX message. This type of file cannot be extracted. You must write code to access the subfile based on the path in the member <code>subFileName</code>.• <code>KVSubFileInfoFlag_MailItem</code>—When the subfile type is <code>KVSubFileType_Attachment</code>, this indicates that the attachment is a mail item. This flag applies to PST, MSG, and NSF files only.

charset	If the subfile is not an attachment, this is the character set of the subfile. If the subfile is an attachment, the character set is KVCS_UNKNOWN.
isMSBLSB	This flag indicates whether the byte order for Unicode text is Big Endian (MSBLSB) or Little Endian (LSBMSB).
fileTime	When the subfile is a mail message, this is the file's Sent time. Otherwise, it is the last modified time. The file time is not available for the following file types: <ul style="list-style-type: none">• EML attachments• OLE objects in a Microsoft Office document• Embedded images
parentIndex	The index number of this file's parent. For example, the index of a folder in which the subfile is stored, or the file to which the subfile is attached. If a file does not have a parent, the parentIndex is -1.
childCount	The number of first-level children in the subfile.
childArray	A pointer to an array of first-level children in the subfile.

Discussion

- The KVSubFileType_Main type applies to the following for each file format:

File format	KVSubFileType_Main applies to...
MSG and EML	The message body.
Zip files	A file inside the archive.
PST files	An item that is not an attachment, an OLE object, or a root node.
MBX files	A message in the MBX file.
NSF files	An item that is not an attachment, an OLE object, or a root node.
PDF files	An item that is not an attachment or a root node.

- If you set the KVSubFileInfoFlag_NeedsExtraction flag, open the subfile and extract its children. See [fpOpenFile\(\)](#), on page 149 and [fpExtractSubFile\(\)](#), on page 142.
- The parentIndex and childArray members provide information about the subfile's parent and children. You can use this information to recreate the file hierarchy on extraction. Because childArray retrieves only the first-level children in the subfile, you must call fpGetSubFileInfo () repeatedly until information for the leaf-node children is extracted. See [Recreate a File's Hierarchy](#), on page 58.

KVSubFileMetaData

This structure contains a count of the number of metadata elements extracted from a mail file, and a pointer to the first element of the array of elements. It is initialized by calling [fpGetSubFileMetaData\(\)](#). This structure is defined in `kvextract.h`.

```
typedef struct tag_KVSubFileMetaData
{
    KVStructHeader;
    int          nElem;
    KVMetadataElem** ppElem;
    unsigned long infoFlag;
}
KVSubFileMetaDataRec, *KVSubFileMetaData;
```

Member Descriptions

<code>KVStructHeader</code>	The KeyView version of the structure. See KVStructHead , on page 224.
<code>nElem</code>	The number of metadata fields contained in the array.
<code>ppElem</code>	A pointer to an array of pointers that are the memory addresses of metadata field values in the KVMetadataElem structure.
<code>infoFlag</code>	A bitwise flag that defines additional properties of the extracted metadata. The following flag is available: <code>KVSubFileMetaInfoFlag_CharsetConverted</code> —Indicates that the metadata's character set was converted.

Chapter 8: HTML Export API Functions

This section describes the functions in the HTML Export API. These functions manage the input and output streams, and perform the document conversion. Each function appears as a function prototype followed by a description of its arguments, its return value, and discussion of its use.

• KVHTMLGetInterfaceEx()	168
• KVHTMLGetInterfaceEx2()	168
• fpConfigureRMS()	170
• fpConvertStream()	171
• fpFileToInputStreamCreate()	173
• fpFileToInputStreamFree()	174
• fpFileToOutputStreamCreate()	175
• fpFileToOutputStreamFree()	176
• fpFreePartitionInfoList	177
• fpGetAnchor()	178
• fpGetConvertFileList()	179
• fpGetKvErrorCode	180
• fpGetKvErrorCodeEx	180
• fpGetPartitionInfoList	181
• fpGetStreamInfo()	182
• fpGetSummaryInfo()	182
• fpInit()	184
• fpInitWithLicenseData()	185
• fpSetPartitionOn	187
• fpSetStyleMapping()	188
• fpShutDown()	189
• fpValidateTemplate()	190
• KVHTMLConfig()	190
• KVHTMLConvertFile()	198
• KVHTMLEndOOPSession()	200
• KVHTMLSetHighlight()	202
• KVHTMLSetStyleSheet()	204
• KVHTMLStartOOPSession()	205

KVHTMLGetInterfaceEx()

NOTE: This function has been superseded by [KVHTMLGetInterfaceEx2\(\)](#); `KVHTMLInterfaceEx2()` should be used instead of `KVHTMLInterfaceEx()`.

This is exported by the Export definition file. It supplies function pointers to other Export functions. When `KVHTMLGetInterfaceEx()` is called, it assigns the function pointers in the `KVHTMLInterfaceEx` structure to other functions described in this chapter. For example, `KVHTMLInterfaceEx.fpInit` is assigned to point to `KVHTMLInitEx()`.

Syntax

```
void pascal KVHTMLGetInterfaceEx (KVHTMLInterfaceEx *pInterface);
```

Arguments

`pInterface` A pointer to the structure `KVHTMLInterfaceEx`. See [KVHTMLInterfaceEx](#), on page 232.

Returns

None.

Discussion

- One of the initial steps in using the HTML Export API is to create an instance of a `KVHTMLInterfaceEx` structure and use this function to gain access to other functions.
- You can call the API functions directly. For example, you can call `KVHTMLGetSummaryInfo()` instead of using `fpGetSummaryInfo()` in `KVHTMLInterfaceEx`. However, Micro Focus recommends that you assign the function pointers in `KVHTMLInterfaceEx` to the functions for efficiency.

KVHTMLGetInterfaceEx2()

This function is exported by the Export definition file. It supplies function pointers to other Export functions. When `KVHTMLGetInterfaceEx2()` is called, it assigns the function pointers in the structure `KVHTMLInterfaceEx2` to other functions described in this chapter. For example, `KVHTMLInterfaceEx2.fpInit` is assigned to point to `KVHTMLInitEx()`.

Syntax

```
BOOL pascal KVHTMLGetInterfaceEx2 (KVHTMLInterfaceEx2 *pInterface);
```

Arguments

`pInterface` A pointer to the structure `KVHTMLInterfaceEx2`. See [KVHTMLInterfaceEx2](#), on page 234.

Returns

- If the call is successful, the return value is `TRUE`.
- If the call is unsuccessful, the return value is `FALSE`.

If the function fails, all function pointers in `pInterface` are set to `NULL`.

You must initialize `pInterface` by calling `KVStructInit` prior to passing it to `KVHTMLGetInterfaceEx2`. If you do not do this, the function fails.

Discussion

- One of the initial steps in using the HTML Export API is to create an instance of a `KVHTMLInterfaceEx2` structure and use this function to gain access to other functions.
- The API functions can be called directly. For example, you can call `KVHTMLGetSummaryInfo()` instead of using `fpGetSummaryInfo()` in `KVHTMLInterfaceEx2`. However, Micro Focus recommends that you assign the function pointers in `KVHTMLInterfaceEx2` to the functions for efficiency.
- You must initialize `KVHTMLInterfaceEx2` by calling `KVStructInit` prior to passing it to `KVHTMLGetInterfaceEx2`, otherwise `KVHTMLGetInterfaceEx2` fails.

Example

```
KVHTMLInterfaceEx2 KVHTMLInt;  
BOOL (pascal *fpGetInterfaceEx2)(KVHTMLInterfaceEx2 *);  
...  
KVStructInit(&KVHTMLInt);  
(*fpGetInterfaceEx2)(&KVHTMLInt);
```

fpConfigureRMSO

This function provides a way to set the credentials required to access Azure RMS protected files. After you set these credentials, the HTML Export and File Extraction API functions can operate on the contents of the Azure RMS files. This functionality is only available when running in process.

Syntax

```
KVErrorCode pascal *fpConfigureRMS(  
    void*          pContext,  
    KVRMSCredentials* credentials);
```

Arguments

pContext A pointer returned from [fpInit\(\)](#) and [fpInitWithLicenseData\(\)](#).

credentials A pointer to a `KVRMSCredentials` structure that contains the required credentials. See [KVRMSCredentials](#), on page 221.

Set this value to NULL to discard the existing credentials. You can call the function again with new credentials to override the existing configuration.

Before you fill out the `KVRMSCredentials` structure, use the macro `KVStructInit` to initialize the `KVStructHead` structure.

Returns

The return value is an error code. See [KVErrorCode](#), on page 258.

If the function returns `KVERR_General`, you can retrieve the extended error code by using the `fpGetKvErrorCodeEx()` function (see [fpGetKvErrorCodeEx](#), on page 180).

Discussion

- This function has an effect only when you export or extract documents in-process. KeyView does not currently support exporting or extracting RMS protected documents out-of-process.
- Azure RMS decryption is licensed as an additional product. If your license does not allow for Azure RMS decryption, this function returns the extended error code `KVError_ReaderUsageDenied`.
- To access the protected content, KeyView must make an HTTP request. The time required to do so means that KeyView processes protected files slower than unprotected files.

- By default, KeyView uses the system proxy when it makes HTTP requests to obtain the key. You can also specify the proxy manually in the configuration file. See [Configure the Proxy for RMS, on page 120](#).
- This function is supported only on Windows 64-bit, Linux 64-bit, Solaris SPARC 64-bit, and Solaris x86 64-bit. On Linux 64-bit, the minimum supported versions of particular distributions are:
 - Red Hat Enterprise Linux (RHEL) 6
 - CentOS 6
 - SuSE Linux Enterprise Server (SLES) 12

CAUTION: When HTML Export or File Extraction API functions access the protected contents of Azure RMS-protected files, KeyView may place decrypted contents into the temporary directory. If you want to manage the security of such files, you might want to change the temporary directory, by using [KVHTMLConfig\(\)](#).

fpConvertStream()

This function converts either a source stream or file to an output stream.

Syntax

```
BOOL pascal fpConvertStream(  
    void *pContext,  
    void *pCallingContext,  
    KVInputStream *pInput,  
    KVOutputStream *pOutput,  
    KVHTMLTemplateEx *pTemplatesEx,  
    KVHTMLOptionsEx *pOptionsEx,  
    KVHTMLCallbacksEx *pCallbacksEx,  
    KVHTMLTOCOptions *pTOCCreateOptions,  
    BOOL bIndex,  
    KVErrCode *pError );
```

Arguments

pContext	A pointer returned from fplnit() or fplnitWithLicenseData() .
pCallingContext	A pointer passed back to the callback functions.
pInput	A pointer to the developer-assigned instance of KVInputStream. The KVInputStream structure defines the input stream that contains the source for the conversion. See KVInputStream, on page 216 .

<code>pOutput</code>	<p>A pointer to the developer-assigned instance of <code>KVOutputStream</code>. The <code>KVOutputStream</code> structure defines the output stream to which Export writes the generated HTML. See KVOutputStream, on page 218.</p>
<code>pTemplatesEx</code>	<p>A pointer to the <code>KVHTMLTemplateEx</code> data structure. It defines the overall structure of the output. Individual elements within the structure define the markup written at specific points in the output stream. See KVHTMLTemplateEx, on page 246.</p> <p>If this pointer is <code>NULL</code>, the default values for the structure are used.</p>
<code>pOptionsEx</code>	<p>A pointer to the <code>KVHTMLOptionsEx</code> data structure. It defines the options that control the markup written in response to the general style and attributes (font, color, and so on) of the document. See KVHTMLOptionsEx, on page 237.</p> <p>If this pointer is <code>NULL</code>, the default values for the structure are used.</p>
<code>pCallbacksEx</code>	<p>A pointer to the <code>KVHTMLCallbacksEx</code> data structure. It is a structure of functions that Export calls for specific, user-defined purposes. See KVHTMLCallbacksEx, on page 228.</p> <p>If callbacks are not used, this can be <code>NULL</code>.</p>
<code>pTOCCreateOptions</code>	<p>A pointer to the <code>KVHTMLTOCOptions</code> data structure. It specifies whether a heading is included in the table of contents. See KVHTMLTOCOptions, on page 250.</p> <p>If this pointer is <code>NULL</code>, the default values for the structure are used.</p>
<code>bIndex</code>	<p>Set <code>bIndex</code> to <code>TRUE</code> to generate output with minimal markup and without images. Because the generated output is minimized to textual content, it is suitable for an indexing engine. If you set <code>bIndex</code> to <code>FALSE</code>, embedded images in a document are regenerated as separate files and stored in the output directory.</p> <p>You can also set this option through the bNoPictures, on page 244 member in the template files.</p>
<code>pError</code>	<p>A pointer to an error code if the call to <code>fpConvertStream()</code> fails.</p>

Returns

- If the call is successful, the return value is `TRUE`.
- If the call is unsuccessful, the return value is `FALSE`.

Discussion

- Only `pContext`, `pInput`, `pOutput`, and `bIndex` are required. All other pointers should be `NULL` when they are not set.

- If pCallbacksEx is NULL, pOptionsEx->pszDefaultOutputDirectory must be valid, except when bIndex is set to TRUE.
- This function runs in-process or out of process. See [Convert Files Out of Process, on page 31](#).
- When converting out of process, this function must be called after the call to KVHTMLStartOOPSession() and before the call to KVHTMLEndOOPSession(). See [KVHTMLStartOOPSession\(\), on page 205](#) and [KVHTMLEndOOPSession\(\), on page 200](#).
- When converting out of process, the values for the KVHTMLTemplateEx, KVHTMLOptionsEx, and KVHTMLTOCOptions structures should be set to NULL. These structures are already passed in the call to KVHTMLStartOOPSession(). See [KVHTMLStartOOPSession\(\), on page 205](#).

Example

The following sample code is from the cnv2html sample program:

```
if(!(*KVHTMLInt.fpConvertStream)(
    pKVHTML,          /* A pointer returned by fpInit() */
    NULL,             /* A pointer for callback functions */
    &Input,           /* Input stream */
    &Output,          /* Output stream */
    &HTMLTemplates,  /* Markup and related variables */
    &HTMLOptions,    /* Options */
    NULL,            /* A pointer to callback functions */
    NULL,           /* TOC options */
    FALSE,         /* Index mode */
    &error))       /* Error return value */
{
    printf("Error converting %s to HTML %d\n", argv[i - 1], error);
}
else
{
    printf("Conversion of %s to HTML completed.\n\n", argv[i - 1]);
}
```

fpFileToInputStreamCreate()

This function creates an input stream from an input file.

Syntax

```
BOOL pascal _export fpFileToInputStreamCreate(
    void          *pContext,
    char          *pszFileName,
    KVInputStream *pInput);
```

Arguments

- pContext** A pointer returned from [fpInit\(\)](#) or [fpInitWithLicenseData\(\)](#).
- pszFileName** A pointer to the name of the input file to be converted.
- pInput** A pointer to the developer-assigned instance of `KVInputStream`. The `KVInputStream` structure defines the input stream that contains the source for the conversion. See [KVInputStream](#), on page 216.

Returns

- If the call is successful, the return value is `TRUE`.
- If this call is unsuccessful, the return value is `FALSE`. Processing is halted.

Discussion

After the conversion is complete, call `fpFileToInputStreamFree()` to free the memory allocated by this function.

Example

The following sample code is from the `cnv2html` sample program:

```
if(!(*KVHTMLInt.fpFileToInputStreamCreate)(pKVHTML, argv[i++], &Input))
{
    printf("Error creating input stream\n");
    (*KVHTMLInt.fpShutDown)(pKVHTML);
    mpFreeLibrary(hKVHTML);
    return (5);
}
```

fpFileToInputStreamFree()

This function frees the memory used to create an input stream.

Syntax

```
BOOL pascal _export fpFileToInputStreamFree(
    void          *pContext,
    KVInputStream *pInput);
```

Arguments

- pContext** A pointer returned from [fpInit\(\)](#) or [fpInitWithLicenseData\(\)](#).
- pInput** A pointer to the developer-assigned instance of `KVInputStream`. The `KVInputStream` structure defines the input stream that contains the source for the conversion. See [KVInputStream](#), on page 216.

Returns

- If the call is successful, the return value is `TRUE`.
- If this call is unsuccessful, the return value is `FALSE`. Processing is halted.

Discussion

After the conversion is complete, call this function to free the memory allocated by `fpFileToInputStreamCreate()`.

fpFileToOutputStreamCreate()

This function creates an output stream from an output file.

Syntax

```
BOOL pascal _export fpFileToOutputStreamCreate(  
    void          *pContext,  
    char          *pszFileName,  
    KVOutputStream *pOutput );
```

Arguments

- pContext** A pointer returned from [fpInit\(\)](#) or [fpInitWithLicenseData\(\)](#).
- pszFileName** A pointer to the name of the output file to create.
- pOutput** A pointer to the developer-assigned instance of `KVOutputStream`. The `KVOutputStream` structure defines the output stream to which Export writes the generated HTML. See [KVOutputStream](#), on page 218.

Returns

- If the call is successful, the return value is TRUE.
- If this call is unsuccessful, the return value is FALSE. Processing is halted.

Discussion

After the conversion is complete, call `fpFileToOutputStreamFree()` to free the memory allocated by this function.

Example

The following sample code is from the `cnv2html` sample program:

```
if (!(*KVHTMLInt.fpFileToOutputStreamCreate)(pKVHTML, argv[i], &Output))
{
    printf("Error creating output stream\n");
    (*KVHTMLInt.fpFileToInputStreamFree)(pKVHTML, &Input);
    (*KVHTMLInt.fpShutDown)(pKVHTML);
    mpFreeLibrary(hKVHTML);
    return 6;
}
```

fpFileToOutputStreamFree()

This function frees the memory used to create the output stream.

Syntax

```
BOOL pascal _export fpFileToOutputStreamFree(
    void *pContext,
    KVOutputStream *pOutput );
```

Arguments

pContext A pointer returned from [fpInIt\(\)](#) or [fpInItWithLicenseData\(\)](#).

pOutput A pointer to the developer-assigned instance of `KVOutputStream`. The `KVOutputStream` structure defines the output stream to which Export writes the generated HTML. See [KVOutputStream, on page 218](#).

Returns

- If the call is successful, the return value is `TRUE`.
- If this call is unsuccessful, the return value is `FALSE`. Processing is halted.

Discussion

After the conversion is complete, call this function to free the memory allocated by `fpFileToOutputStreamCreate()`.

fpFreePartitionInfoList

This function frees a [KVPartitionInfoList](#) that was allocated by [fpGetPartitionInfoList\(\)](#).

Syntax

```
void pascal fpFreePartitionInfoList (  
void* pContext,  
KVPartitionInfoList* pPartitionInfoList)
```

Arguments

<code>pContext</code>	A pointer returned from fpInit() or fpInitWithLicenseData() .
<code>pPartitionInfoList</code>	A pointer to a KVPartitionInfoList instance. The <code>fpFreePartitionInfoList</code> function frees the resources associated with this structure.

Returns

None.

Discussion

This function is idempotent; that is, it does not do anything if you call it again on the same `pPartitionInfoList`.

You must call `fpFreePartitionInfoList` before you call [fpShutDown\(\)](#).

fpGetAnchor()

This function gets the file name automatically generated by Export and used for external graphics referenced with tags and for heading-level table of contents entries.

Syntax

```
BOOL pascal fpGetAnchor(  
    void *pCallingContext,  
    KVHTMLAnchorTypeEx eAnchorTypeEx,  
    KVXMLAnchorType eAnchorType,  
    char *pszAnchor,  
    int cbAnchorMax,  
    BYTE *pcHTML,  
    UINT cbHTML);
```

Arguments

pCallingContext	A pointer passed back to the callback functions.
eAnchorTypeEx	The graphic or block anchor type for the output stream. It must be one of the enumerated types defined in KVHTMLAnchorTypeEx. See KVHTMLAnchorTypeEx, on page 264 .
pszAnchor	A pointer to the location in which the new anchor is stored.
cbAnchorMax	The maximum number of bytes to place in pszAnchor.
pcHTML	A pointer to either the markup defining the contents of the table of contents entry, a pointer to the external graphic name, or NULL.
cbHTML	The number of valid bytes in pcHTML.

Returns

- If the call is successful, the return value is TRUE.
- If this call is unsuccessful, the return value is FALSE. Processing is halted.

Discussion

- `pszAnchor` must be assigned. It might be derived from the `cbAnchorMax`, `pcHTML`, and `cbHTML` values that are also provided.
- `pcHTML` can be `NULL` if the graphic is an internal part of the document.
- This function is exposed so that it can be called from the `GetAnchor()` callback function to obtain default behavior for anchor types the callback is not set to handle.

fpGetConvertFileList()

This function gets the list of files automatically converted to HTML during a call to `fpConvertStream()` or `KVHTMLConvertFile()`.

Syntax

```
char ** pascal _export fpGetConvertFileList(  
    void *pContext,  
    int *pnSize );
```

Arguments

`pContext` A pointer returned from [fpInit\(\)](#) or [fpInitWithLicenseData\(\)](#).

`pnSize` A pointer to the number of files generated by the conversion.

Returns

If no files are converted, the return value is a `NULL` pointer. Otherwise, the return value is a pointer to an array of strings that provides the available path information for each converted file.

Discussion

- The array of file path information includes all externally generated files, including graphic files. Note that the main output file is not included in the array, nor in the count of the number of files converted.
- The memory used by the array of file path information is freed by the API.
- The array is not valid after a call to `fpShutdown()`.

- This function runs in-process or out of process. See [Convert Files Out of Process, on page 31](#).
- When converting out of process, this function must be called after the call to `KVHTMLStartOOPSession()` and before the call to `KVHTMLEndOOPSession()`. See [KVHTMLStartOOPSession\(\), on page 205](#) and [KVHTMLEndOOPSession\(\), on page 200](#).

fpGetKvErrorCode

This function gets an extended error code defined in `KVErrorCode`. If a KeyView HTML Export function fails, you can call `fpGetKvErrorCode()` to find extra information on the failure.

Syntax

```
KVErrorCode pascal fpGetKvErrorCode (  
    void          *pContext );
```

Arguments

`pContext` A pointer returned from [fpInit\(\)](#) or [fpInitWithLicenseData\(\)](#).

Returns

The current error code.

Discussion

If there has not been a failure, this function returns `KVERR_Success`.

fpGetKvErrorCodeEx

This function gets an extended error code defined in `KVErrorCodeEx`. It is called to provide additional information when `fpGetKvErrorCode()` returns the error `KVERR_General`.

Syntax

```
KVErrorCodeEx pascal fpGetKvErrorCodeEx (  
    void          *pContext );
```

Arguments

`pContext` A pointer returned from [fpInIt\(\)](#) or [fpInItWithLicenseData\(\)](#).

Returns

The current extended error code.

fpGetPartitionInfoList

This function allocates and fills a [KVPartitionInfoList](#) instance. This list gives you the information you need to arrange the output so that you can view it in your preferred layout. For more information, see [Partitioning, on page 119](#).

Syntax

```
KVErrorCode pascal fpGetPartitionInfoList (  
void* pContext,  
KVPartitionInfoList* pPartitionInfoList)
```

Arguments

`pContext` A pointer returned from [fpInIt\(\)](#) or [fpInItWithLicenseData\(\)](#).

`pPartitionInfoList` A pointer to a [KVPartitionInfoList](#) instance.

Returns

The return value is one of the error codes defined in [KVErrorCode](#) in `kverrorcodes.h`.

Discussion

This function runs in-process or out of process. See [Convert Files Out of Process, on page 31](#).

When you convert out of process, you must call this function after the call to [KVHTMLStartOOPSession\(\)](#) and before the call to [KVHTMLEndOOPSession\(\)](#).

When you have finished using `pPartitionInfoList`, you must call [fpFreePartitionInfoList](#) to free the memory that this function allocates, before you call [fpShutDown\(\)](#).

fpGetStreamInfo()

This function extracts file format and character set information from the source document.

Syntax

```
BOOL pascal _export fpGetStreamInfo (  
    void *pContext,  
    KVInputStream *pInput,  
    KVStreamInfo *pStreamInfo );
```

Arguments

- pContext** A pointer returned from [fpInit\(\)](#) or [fpInitWithLicenseData\(\)](#).
- pInput** A pointer to the developer-assigned instance of `KVInputStream`. The `KVInputStream` structure defines the input stream that contains the source for the conversion. See [KVInputStream, on page 216](#).
- pStreamInfo** A pointer to the developer-assigned instance of `KVStreamInfo`. The `KVStreamInfo` structure defines the input stream document type and character set. See [KVStreamInfo, on page 223](#).
- You can examine the fields in the structure to determine the appropriate template to use based on the document type.

Returns

- If the call is successful, the return value is `TRUE`.
- If this call is unsuccessful, the return value is `FALSE`.

fpGetSummaryInfo()

This function extracts all metadata from the input stream. See [Extract Metadata, on page 79](#) for more information.

Syntax

```
BOOL pascal _export fpGetSummaryInfo(  
    void *pContext,  
    KVInputStream *pInput,  
    KVSummaryInfoEx *pSummary,  
    BOOL bFree );
```

Arguments

- pContext** A pointer returned from [fplnit\(\)](#) or [fplnitWithLicenseData\(\)](#).
- pInput** A pointer to the developer-assigned instance of `KVInputStream`. The `KVInputStream` structure points to the input stream that contains the source for the conversion. See [KVInputStream, on page 216](#).
- pSummary** A pointer to the developer-assigned instance of `KVSummaryInfoEx`.
In this structure, `nElem` provides a count of the number of metadata elements, and `pElem` points to the first element of the array of individual elements as defined by the structure `KVSumInfoElemEx`. See [KVSummaryInfoEx, on page 226](#).
- bFree** A flag to free or fill the memory allocated to the document metadata.

Returns

- If the call is successful, the return value is `TRUE`. When the document does *not* contain metadata, but the document reader can extract metadata from the specified format, this function returns `TRUE` with `nElem` set to 0.
- If this call is unsuccessful, the return value is `FALSE`. This function returns `FALSE` when the document reader does not support metadata extraction for the specified format, or there is an error in extraction. The section [Document Readers, on page 392](#) lists the file formats for which metadata can be determined.

Discussion

- For metadata to be extracted by Export, metadata must be defined in the source document, and the document reader must be able to extract metadata for the file format. [Document Readers, on page 392](#) lists the file formats for which metadata can be determined. Export does not generate metadata automatically from the document contents.
- This function runs in-process or out of process. See [Convert Files Out of Process, on page 31](#).
- You can call this function at any time after the call to [fplnit\(\)](#) or [fplnitWithLicenseData\(\)](#).

- When converting out of process, this function must be called after the call to `KVHTMLStartOOPSession()` and before the call to `KVHTMLEndOOPSession()`. See [KVHTMLStartOOPSession\(\), on page 205](#) and [KVHTMLEndOOPSession\(\), on page 200](#).
- Call this function with `bFree` set to **FALSE** to return an array of `KVSummaryInfoEx` structures, each containing an element of available document metadata.
- After processing the information in the structure, call this function with `bFree` set to **TRUE** to free the memory allocated to the document metadata.

fpInit()

This function initializes an Export session. Its return value, `pContext`, is passed as the first parameter to the File Extraction interface and all other Export functions.

DEPRECATED: The `fpInit()` function is deprecated in KeyView 12.7.0 and later. Micro Focus recommends that you use [fpInitWithLicenseData\(\)](#) instead, so that your license key is passed to KeyView through the API. You should not include license information in your application as a file (`kv.lic`).

This function is still available for existing implementations, but it might be incompatible with new functionality. The function might be removed in future.

Syntax

```
void* pascal _export fpInit(  
    KVMemoryStream *pMemAllocator,  
    char *pszKeyViewDir,  
    char *pszDataFile,  
    KVErrorCode *pError,  
    DWORD dWord);
```

Arguments

- `pMemAllocator` A pointer to a developer-defined memory allocator. If `NULL` is passed, the default C run-time memory allocation is used.
- `pszKeyViewDir` A pointer to the directory where the Export components are located. This is normally the directory `install\OS\bin`, where `install` is the path name of the Export installation directory and `OS` is the name of the operating system.
- `pszDataFile` A pointer to the directory and file name of the Export data file, `formats_e.ini`. This file determines whether a format is supported. If a format does not exist in this file, the conversion fails.

The `formats_e.ini` file is normally stored in the directory `install\OS\bin`, where `install` is the path name of the Export installation directory and `OS` is the name of the operating system. See [File Format Detection, on page 454](#) for more information.

<code>pError</code>	A pointer to an error code defined in <code>KVErrorCode</code> or <code>KVErrorCodeEx</code> in <code>kverrorcodes.h</code> . See KVErrorCode, on page 258 and KVErrorCodeEx, on page 260 .
<code>dWord</code>	Reserved. Must be 0.

Returns

- If the call is successful, the return value is a pointer passed to all other functions.
- If the call is unsuccessful, the return value is a NULL pointer.

Discussion

- If `pszKeyViewDir` is NULL, the required components cannot be found. Ensure that it is valid.
- If this function returns NULL, check `stderr` for the KeyView installation error messages, "KeyView Export SDK License Key has Expired" and "KeyView Export SDK License Key is Invalid", and pass them to your application. See the *Export SDK Installation Instructions* for more information on the KeyView license feature.
- To ensure multithreaded conversions are thread-safe, you must create a unique context pointer for every thread by calling `fpInit()`. In addition, threads must not share context pointers, and the same context pointer must be used for all API calls in the same thread. Creating a context pointer for every thread does not affect performance because the context pointer uses minimal resources.
- When the conversion context is no longer required, it should be terminated by calling `fpShutdown()`. See [fpShutdown\(\), on page 189](#).

fpInitWithLicenseData()

This function initializes an Export session with license information passed in function parameters rather than a license file. Its return value, `pContext`, is passed as the first parameter to the File Extraction interface and all other Export functions.

This function is similar to [fpInit\(\)](#), but it uses a different licensing method. You can use either [fpInit\(\)](#) or `fpInitWithLicenseData` to initialize your Export session. However, these functions are mutually exclusive. That is, neither takes the context pointer from the other as an argument. If you call both functions, you initialize two distinct Export sessions, in the same way as calling [fpInit\(\)](#) twice.

Syntax

```
void* pascal _export fpInitWithLicenseData(  
    KVMemoryStream*    pMemAllocator,  
    char*              pszKeyViewDir,  
    const char* const  pszLicenseOrganization  
    const char* const  pszLicenseKey  
    char*              pszDataFile,  
    KVErrorCode*       pError,  
    DWORD              dWord);
```

Arguments

<code>pMemAllocator</code>	A pointer to a developer-defined memory allocator. If NULL is passed, the default C run-time memory allocation is used.
<code>pszKeyViewDir</code>	A pointer to the directory where the Export components are located. This is normally the directory <i>install\OS\bin</i> , where <i>install</i> is the path name of the Export installation directory and <i>OS</i> is the name of the operating system.
<code>pszLicenseOrganization</code>	A pointer to a string that contains the organization name under which this installation of KeyView is licensed. This value is the company name that appears at the top of the license key provided by Micro Focus. Add the text exactly as it appears in this file.
<code>pszLicenseKey</code>	A pointer to a string that contains the license key for this installation of KeyView. This value is the appropriate license key provided by Micro Focus. The key is a string that contains 31 characters, for example 2TQD22D-2M6FV66-2KPF23S-2GEM5AB. Type these characters exactly as they appear in the license key file, including the dashes, but do not include any leading or trailing spaces.
<code>pszDataFile</code>	A pointer to the directory and file name of the Export data file, <i>formats_e.ini</i> . This file determines whether a format is supported. If a format does not exist in this file, the conversion fails. The <i>formats_e.ini</i> file is normally stored in the directory <i>install\OS\bin</i> , where <i>install</i> is the path name of the Export installation directory and <i>OS</i> is the name of the operating system. See File Format Detection, on page 454 for more information.
<code>pError</code>	A pointer to an error code defined in <code>KVErrorCode</code> or <code>KVErrorCodeEx</code> in <code>kverrorcodes.h</code> . See KVErrorCode, on page 258 and KVErrorCodeEx, on page 260 .
<code>dWord</code>	Reserved. Must be 0.

Returns

- If the call is successful, the return value is a pointer passed to all other functions.
- If the call is unsuccessful, the return value is a NULL pointer.

Discussion

- If `pszKeyViewDir` is NULL, the required components cannot be found. Ensure that it is valid.
- If this function returns NULL, check `stderr` for the KeyView installation error messages, "KeyView Export SDK License Key has Expired" and "KeyView Export SDK License Key is Invalid", and pass them to your application. See the *Export SDK Installation Instructions* for more information on the KeyView license feature.
- To ensure multithreaded conversions are thread-safe, you must create a unique context pointer for every thread by calling `fpInit()` or `fpInitWithLicenseData()`. In addition, threads must not share context pointers, and the same context pointer must be used for all API calls in the same thread. Creating a context pointer for every thread does not affect performance because the context pointer uses minimal resources.
- When the conversion context is no longer required, it should be terminated by calling `fpShutDown()`.

Example

The following sample code is from the `cnv2html` sample program:

```
pKVHTML = (*KVHTMLInt.fpInitWithLicenseData)(NULL, szDir, YOUR_LICENSE_
ORGANIZATION, YOUR_LICENSE_KEY, NULL, &error, 0);
if(!pKVHTML)
{
    printf("Error initializing KVHTML: %d\n", error);
    mpFreeLibrary(hKVHTML);
    return 4;
}
```

fpSetPartitionOn

This function tells KeyView when to begin a new partition. For more information, see [Partitioning, on page 119](#).

Syntax

```
KVErrorCode pascal fpSetPartitionOn(  
    void* pContext,  
    const KVPartitionSetOn* pSetPartitionOn);
```

Arguments

- pContext** A pointer returned from [fplnit\(\)](#) or [fplnitWithLicenseData\(\)](#).
- pSetPartitionOn** A pointer to a [KVPartitionSetOn](#) structure that tells KeyView when to create a new partition.

Returns

The return value is one of the error codes defined in [KVErrorCode](#) in `kverrorcodes.h`.

Discussion

This function runs in-process or out of process. See [Convert Files Out of Process, on page 31](#).

When you convert out of process, you must call this function after the call to [KVHTMLStartOOPSession\(\)](#) and before the call to [KVHTMLEndOOPSession\(\)](#).

When you convert Word Processing documents with partitioning on hard breaks or page size changes:

- To create a table of contents by using the Export Tokens (see [Export Tokens, on page 451](#)) in the [KVHTMLTemplateEx](#) structure, you must set the `pszChunkTemplate` member in [KVHTMLTemplateEx](#).
- When you turn off partitioning on headings, you must not create a table of contents by using the Export Tokens (see [Export Tokens, on page 451](#)) in the [KVHTMLTemplateEx](#) structure. Instead, Micro Focus recommends that you create a table of contents by using the information from [fpGetPartitionInfoList](#).

fpSetStyleMapping()

This function is used to set the mapping for user-defined styles. Export does not make a distinction between paragraph styles or character styles, but operates under the assumption that each style has a unique name.

Syntax

```
BOOL pascal _export fpSetStyleMapping(  
    void      *pContext,  
    KVStyle   *pStyles,  
    int       iStyles,  
    BOOL      bCopy);
```

Arguments

- pContext** A pointer returned from [fplnit\(\)](#) or [fplnitWithLicenseData\(\)](#).
- pStyles** A pointer to the developer-assigned instance of `KVStyle`. See [KVStyle](#), on page 224. The `KVStyle` structure defines the elements of a custom style.
- iStyles** The number of elements in the `pStyles` array.
- bCopy** If Export is to allocate memory to copy the `pStyles` array, set this to **TRUE**. If `pStyles` remains valid throughout the conversion process, set this to **FALSE**.

Returns

- If the call is successful, the return value is **TRUE**.
- If this call is unsuccessful, the return value is **FALSE**.

Discussion

- Paragraph styles are presently implemented only for documents in Microsoft Word 97-2003 (DOC), RTF, Folio Flat files, WordPro, and WordPerfect 6.x.
- This function runs in-process or out of process. See [Convert Files Out of Process](#), on page 31.
- When converting out of process, this function must be called after the call to `KVHTMLStartOOPSession()` and before the call to `KVHTMLEndOOPSession()`. See [KVHTMLStartOOPSession\(\)](#), on page 205 and [KVHTMLEndOOPSession\(\)](#), on page 200.
- After this API function is called, the styles are valid until `fpShutDown()` is called, or until this function is called again with a new style or `NULL`.

fpShutDown()

This function terminates an Export session that was initialized by [fplnit\(\)](#) or [fplnitWithLicenseData\(\)](#), and frees allocated system resources. It is called when the conversion context is no longer required.

Syntax

```
void pascal _export fpShutdown(KVHTMLContext *pContext);
```

Arguments

`pContext` A pointer returned from [fpInit\(\)](#) or [fpInitWithLicenseData\(\)](#).

Returns

None.

Discussion

After this function is called, the `pContext` pointer must not be passed to any HTML Export API.

fpValidateTemplate()

This function is used to ensure that the markup in the structures is valid. It is currently not implemented.

KVHTMLConfig()

This function is called directly and provides a way to configure options prior to document conversion. You can use this function to:

- **Enable PDF conversion to JPEG or PNG**
Enable the graphic-based PDF readers `kppdfldr` and `kppdf2ldr` to convert PDF documents to JPEG files.
- **Configure PDF bookmarks**
Specify whether bookmarks in a PDF file are used to create a table of contents in the HTML output.
- **Configure rotated text**
Specify whether rotated text is displayed in its original position or at the bottom of the page. Currently, this option applies only to PDF files.

- **Designate temporary directory**

Specify a directory in which temporary files created during the conversion process are stored.

NOTE: On Windows systems, there is a 64 K size limit to the temporary directory. When the limit is reached, you must either create a new directory or delete the contents of the existing directory; otherwise, you might receive an error message.

- **Configure XML conversion**

Specify the elements and attributes extracted from an XML document based on a file's document type.

- **Enable PDF logical reading order**

Convert paragraphs in PDF files in the order in which they appear on the PDF page and with left-to-right or right-to-left paragraph direction. See [Convert PDF Files to a Logical Reading Order, on page 99](#).

- **Configure PDF soft hyphens**

Specify whether soft hyphens in a PDF file are removed from the HTML output. See [Control Hyphenation, on page 105](#).

- **Enable revision marks**

Convert text and graphics that were deleted from a document with revision tracking enabled and include revision information in the HTML output. See [Include Revision Information, on page 92](#).

- **Enable empty image tags**

Prevent graphics from being converted and generate image tags with empty `src` attributes. This makes the conversion faster, but, because placeholders are generated for the graphics, maintains the text flow of the original document. This is similar to the `bNoPictures` parameter; however, `bNoPictures` does not generate an image tag. See [bNoPictures, on page 244](#).

- **Toggle hidden data output from Microsoft Word, Excel, and PowerPoint documents**

Show or hide information from hidden sources such as comments or slides. See [Show Hidden Data, on page 116](#).

- **Enable a PDF invisible text toggle button**

Enable a JavaScript button that toggles the display of invisible text and regular content in exported PDF documents. [Toggle Invisible Text, on page 103](#).

- **Specify opacity of invisible text in PDFs**

Specify the opacity of invisible text in exported PDF documents, from 0 (invisible) to 100 (fully visible). See [Specify Opacity of Invisible Text, on page 103](#).

- **Protected file password**

Specify the password to use to open a password-protected file for export.

- **Specify output character set for summary information**

Specify the output character set for the document's metadata, when using `fpGetSummaryInfo()`.

- **Enable tabbed spreadsheet view**
Enables a tabbed navigation view for spreadsheets.
- **Enable previews for large spreadsheets**
Limits the number of rows, columns, and sheets that are exported to HTML.

Syntax

```
KVErrorCode pascal KVHTMLConfig(  
    void *pContext,  
    int nType,  
    int nValue,  
    void *p );
```

Arguments

- pContext** A pointer returned from [fplnit\(\)](#) or [fplnitWithLicenseData\(\)](#).
- nType** The configuration flag. This is a symbolic constant defined in `kvtypes.h`. The available options are described in [Configuration Flags for KVHTMLConfig\(\)](#), on the next page.
- nValue** The integer value defined for the flags above. This is TRUE or FALSE for all flags except:
- `KVCFG_LOGICALPDF`—`nValue` is one of the paragraph direction options defined in the `LPDF_DIRECTION` enumerated type in `kvtypes.h`. See [LPDF_DIRECTION](#), on page 275.
 - `KVCFG_SETTEMPDIRECTORY`—`nValue` is not set.
 - `KVCFG_SETXMLCONFIGINFO`—`nValue` is not set.
 - `KVCFG_SETINVISTEXTTOGGLE`—`nValue` is not set.
 - `KVCFG_SETINVISTEXTOPACITY`—`nValue` is an integer that specifies text opacity, from 0 (invisible) to 100 (fully visible).
 - `KVCFG_SETMETADATACHARSET`—`nValue` is a character set enumerated in `KVCharSet` in `kvcharset.h`. See [Convert Character Sets](#), on page 83.
- p** The data for the configuration flag. This is NULL for all flags except:
- `KVCFG_SETTEMPDIRECTORY`—This is a pointer to a path to the directory where temporary files are stored.
 - `KVCFG_SETXMLCONFIGINFO`—This is a pointer to the `KVXConfigInfo` structure. See [KVXConfigInfo](#), on page 227.
 - `KVCFG_INCLREVISIONMARK`—This is a pointer to the `KVRevisionMark` structure. See [KVRevisionMark](#), on page 252.
 - `KVCFG_SETINVISTEXTTOGGLE`—This is a null-terminated string that determines the

toggle button name.

- `KVCFG_SETPASSWORD`—This is the source file password.

Returns

The return value is one of the error codes defined in `KVErrorCode` in `kverrorcodes.h`.

Discussion

- You must call this function after the call to `fpInit()` or `fpInitWithLicenseData()` and before the call to `fpConvertStream()` or `KVHTMLConvertFile()`.
- This function runs in-process or out of process. See [Convert Files Out of Process, on page 31](#).
- When converting out of process, this function must be called after the call to `KVHTMLStartOOPSession()` and before the call to `KVHTMLEndOOPSession()`. See [KVHTMLStartOOPSession\(\), on page 205](#) and [KVHTMLEndOOPSession\(\), on page 200](#).
- The configuration flags are described in the following table.

Configuration Flags for `KVHTMLConfig()`

Flag	Description
<code>KVCFG_SETHIFIPDF</code>	This flag enables the graphic-based PDF readers <code>kppdfldr</code> and <code>kppdf2ldr</code> to convert PDF documents. See Use a Graphic-Based Reader, on page 96 . By default, Export uses the basic PDF reader, <code>pdfsr</code> , to convert PDF
<code>KVCFG_SETMETADATACHARSET</code>	This flag enables you to specify the output character set for metadata when using <code>fpGetSummaryInfo()</code> . <code>nValue</code> is a character set enumerated in <code>KVCharSet</code> in <code>kvcharset.h</code> . See Convert Character Sets, on page 83 . You should call this function before <code>fpGetSummaryInfo()</code> .
<code>KVCFG_SUPPRESSTOCPRINTIMAGE</code>	If you set <code>KVCFG_SUPPRESSTOCPRINTIMAGE</code> , bookmarks in a PDF file are not used to generate a table of contents in the HTML output. By default, the table of contents is generated from bookmarks within the PDF file. See Generate a Table of Contents from PDF Bookmarks, on page 102 .
<code>KVCFG_SETTEXTROTATE</code>	If you set <code>KVCFG_SETTEXTROTATE</code> , rotated text in a file is displayed at 0 degrees at the bottom of the page on which it appears. The page is enlarged to accommodate the text. By default, rotated text in a file is displayed in its original position, at the original font size, and at 0 degrees rotation. Because the text is the original size, but might be displayed in a smaller space, the text might

Configuration Flags for KVHTMLConfig(), continued

Flag	Description
	<p>overlap adjacent text in the HTML output. You use the <code>KVCFG_SETTEXTROTATE</code> option to avoid this problem. See Convert Rotated Text, on page 104.</p> <p>HTML markup does not support text rotation.</p>
<p><code>KVCFG_SETTEMPDIRECTORY</code></p>	<p>This flag enables you to specify the directory in which temporary files created during conversion processes are stored. By default, the system temporary directory is used.</p> <p>To define a directory for temporary files generated during an out-of-process conversion, set the <code>tempfilepath</code> parameter in the <code>formats_e.ini</code> file. See Convert Files Out of Process, on page 31.</p> <p>On Windows systems, there is a 64 K size limit to the temporary directory. When the limit is reached, you must either create a new directory or delete the contents of the existing directory; otherwise, you might receive an error message.</p>
<p><code>KVCFG_SETXMLCONFIGINFO</code></p>	<p>This flag enables you to define which elements and attributes are extracted from XML documents with a specified format ID or root element. You can use this to override the default settings for the supported XML formats (see Convert XML Files, on page 111), or to define settings for custom XML document types.</p> <p>The settings are defined in the <code>KVXConfigInfo</code> structure (see KVXConfigInfo, on page 227). To set custom settings for more than one document type, call the <code>KVHTMLConfig()</code> function once for each type.</p> <p>You can also modify element extraction settings by using the <code>kvxconfig.ini</code> file. See Configure Element Extraction for XML Documents, on page 111.</p>
<p><code>KVCFG_LOGICALPDF</code></p>	<p>This flag converts paragraphs in a PDF file in the order in which they appear on the page (logical reading order). The <code>nValue</code> argument specifies the paragraph direction. See Convert PDF Files to a Logical Reading Order, on page 99.</p>
<p><code>KVCFG_DELSOFTHYPHEN</code></p>	<p>If you set this flag, soft hyphens in the source document are removed, and the hyphenated words are joined in the HTML output. By default, soft hyphens are maintained. See Control Hyphenation, on page 105.</p> <p>Micro Focus recommends that you remove soft hyphens if you use Export to generate text output for an indexing engine or are not concerned with maintaining the document's layout. See fpConvertStream(), on page 171 or KVHTMLConvertFile(), on page 198 for more information on running Export in index mode.</p>

Configuration Flags for KVHTMLConfig(), continued

Flag	Description
KVCFG_INCLREVISIONMARK	<p>If you set this flag to TRUE, text and graphics that were deleted from a document with revision tracking enabled are converted, and revision information (revision title, reviewer name, and revision date and time) is included in the HTML output.</p> <p>To reset the flag and exclude deleted content and revision information from the HTML output, set the flag to FALSE. See Include Revision Information, on page 92.</p> <p>The default is FALSE.</p>
KVCFG_BLANKPICTURE	<p>If you set this flag to TRUE, graphics in a document are not converted, but an image tag is generated with an empty <code>src</code> attribute, creating an empty placeholder for the graphic. For example:</p> <pre data-bbox="574 806 1089 835"></pre> <p>This allows you to generate output without graphics, but still maintain the text flow of the original document.</p> <p>This option applies to word processing formats only. The default is FALSE.</p>
KVCFG_WP_NOCOMMENTS	<p>Set this flag to TRUE not to export text from comments in Microsoft Word documents. Comment text is exported by default from Microsoft Word 97 to 2003 files.</p> <p>You can also toggle the display of comment output by modifying the <code>formats_e.ini</code> file. See Show Hidden Data, on page 116.</p>
KVCFG_WP_SHOWHIDDENTEXT	<p>Set this flag to TRUE to export hidden text from Microsoft Word documents.</p>
KVCFG_WP_SHOWDATEFIELDPCODE	<p>Set this flag to TRUE to export date field codes from Microsoft Word documents.</p>
KVCFG_WP_SHOWFILENAMEFIELDPCODE	<p>Set this flag to TRUE to export the file name field code from Microsoft Word documents.</p>
KVCFG_SS_SHOWHIDDENINFOR	<p>Set this flag to TRUE to export hidden information from Microsoft Excel files.</p>
KVCFG_SS_SHOWCOMMENTS	<p>Set this flag to TRUE to export comments from Microsoft Excel files.</p>
KVCFG_SS_SHOWFORMULA	<p>Set this flag to TRUE to export formulas from Microsoft Excel files.</p>
KVCFG_PG_HIDEHIDDENSLIDE	<p>Set this flag to TRUE not to export hidden slides from Microsoft PowerPoint files.</p>
KVCFG_PG_HIDECOMMENT	<p>Set this flag to TRUE not to export comments from Microsoft PowerPoint files. Comments are exported by default from PowerPoint</p>

Configuration Flags for KVHTMLConfig(), continued

Flag	Description
	97 to 2000 files.
KVCFG_PG_SHOWCOMMENTSSLIDE	Set this flag to TRUE to export comments slides from Microsoft PowerPoint 2003 and 2007 files.
KVCFG_PG_SHOWSLIDENOTES	Set this flag to TRUE to export slide notes from Microsoft PowerPoint files. You can also toggle slide note output by modifying the <code>formats_e.ini</code> file. See Show Hidden Data, on page 116 .
KVCFG_SETPDFINVISIBLETEXTTOGGLE	This flag enables a JavaScript button in exported PDF documents, which you can use to show and hide invisible text. Invisible text is hidden by default. See Toggle Invisible Text, on page 103 .
KVCFG_SETPDFINVISIBLETEXTOPACITY	This flag allows you specify the degree of invisible text opacity in exported PDFs, from 0 (invisible) to 100 (opaque). Use this option if you want to view both the invisible text and the rasterized image in the document. Invisible text opacity is set to 0 by default. See Specify Opacity of Invisible Text, on page 103 .
KVCFG_SETPASSWORD	This flag enables you to define a password used to open a password-protected file for export. See Export Password Protected Files, on page 474 . For a list of supported file types, see Supported Password Protected File Types, on page 473 . nValue is TRUE. p is the source file password, which can have a maximum length of 255 characters (the final byte is null).
KVCFG_TABNAVIGATION	If you set this flag to TRUE , it enables a tabbed navigation view for spreadsheets. A row of tabs is displayed at the bottom of the browser window, and enables the user to switch between multiple sheets in a workbook. NOTE: JavaScript must be enabled.
KVCFG_SS_PREVIEW	Specifies whether to export a preview for large spreadsheets rather than exporting all content. Web browsers might take a long time, or fail completely, to render spreadsheets with large numbers of cells. If you set this flag to TRUE , KeyView limits the numbers of rows, columns, and sheets that are exported to HTML.

Examples

- To specify that the graphic-based PDF reader is used to convert PDF files:

```
(*fpHTMLConfig)(pKVHTML, KVCFG_SETHIFIPDF, TRUE, NULL);
```
- To specify that bookmarks in a PDF file are not used to generate a table of contents in the HTML output:

```
(*fpHTMLConfig)(pKVHTML, KVCFG_SUPPRESSTOCPRINTIMAGE, TRUE, NULL);
```
- To specify that rotated text in a file is displayed at 0 degrees at the bottom of the page on which it appears:

```
(*fpHTMLConfig)(pKVHTML, KVCFG_SETTEXTROTATE, TRUE, NULL);
```
- To set a directory for temporary files:

```
char    tmpDir[250];  
strcpy (tmpDir, "c:\\temp\\htmllexport");  
(*fpHTMLConfig)(pKVHTML, KVCFG_SETTEMPDIRECTORY, 0, tmpDir);
```
- To specify custom extraction settings for conversion of an XML file:

```
KVXConfigInfo    xinfo;  
(*fpHTMLConfig)(pKVHTML, KVCFG_SETXMLCONFIGINFO, 0, &xinfo);
```
- To specify that PDF files are converted to a logical reading order, and the paragraph direction for the PDF output is left to right:

```
(*fpHTMLConfig)(pKVHTML, KVCFG_LOGICALPDF, LPDF_LTR, NULL);
```
- To specify that PDF files are converted to a logical reading order, and the paragraph direction for the PDF output is right to left:

```
(*fpHTMLConfig)(pKVHTML, KVCFG_LOGICALPDF, LPDF_RTL, NULL);
```
- To specify that PDF files are converted to a logical reading order, and the paragraph direction for the PDF output is determined automatically for each page:

```
(*fpHTMLConfig)(pKVHTML, KVCFG_LOGICALPDF, LPDF_AUTO, NULL);
```
- To specify that soft hyphens are removed from the HTML output:

```
(*fpHTMLConfig)(pKVHTML, KVCFG_DELSOFTHYPHEN, TRUE, NULL);
```
- To convert text and graphics that are identified by revision marks:

```
KVRevisionMark    RMark;  
(*fpHTMLConfig)(pKVHTML, KVCFG_INCLREVISIONMARK, TRUE, &RMark))
```
- To generate a placeholder for all pictures:

```
(*fpHTMLConfig)(pKVHTML, KVCFG_BLANKPICTURE, TRUE, NULL);
```
- To toggle hidden data output from Microsoft Word documents, use one of the KVCFG_WP flags:

```
(*fpHTMLConfig)(pKVHTML, KVCFG_WP_NOCOMMENTS, TRUE, NULL);
```

- To toggle hidden data output from Microsoft Excel documents, use one of the KVCFG_SS flags:
`(*fpHTMLConfig)(pKVHTML, KVCFG_SS_SHOWHIDDENINFOR, TRUE, NULL);`
- To toggle hidden data output from Microsoft PowerPoint documents, use one of the KVCFG_PG flags:
`(*fpHTMLConfig)(pKVHTML, KVCFG_PG_HIDEHIDDENSLIDE, TRUE, NULL);`
- To enable an invisible text toggle button in exported PDF documents:
`(*fpHTMLConfig)(pKVHTML, KVCFG_SETPDFINVESTEXTTOGGLE, 0, szButtonName);`
where `szButtonName` is a null-terminated string that determines the button name.
- To specify the opacity of invisible text in exported PDF documents:
`(*fpHTMLConfig)(pKVHTML, KVCFG_SETPDFINVESTEXTOPACITY, iInvisOpacity, NULL);`
where `iInvisOpacity` is an integer from 0 (invisible) to 100 (fully visible).
- To specify a password to open a password-protected file for export:
`(*fpHTMLConfig)(pKVHTML, KVCFG_SETPASSWORD, TRUE, password);`
where `password` is a null-terminated string of 255 or fewer characters.
- To produce summary information in UTF8:
`(*fpHTMLConfig)(pKVHTML, KVCFG_SETMETADATACHARSET, KVCS_UTF8, NULL);`
- To export only a preview of spreadsheets to HTML:
`(*fpHTMLConfig)(pKVHTML, KVCFG_SS_PREVIEW, TRUE, NULL);`

KVHTMLConvertFile()

This function is called directly and converts a source file to an output file.

Syntax

```
BOOL pascal KVHTMLConvertFile (  
    void                *pContext,  
    void                *pCallingContext,  
    char                *pInFileName,  
    char                *pOutFileName,  
    KVHTMLTemplateEx   *pTemplatesEx,  
    KVHTMLOptionsEx    *pOptionsEx,  
    KVHTMLCallbacksEx  *pCallbacksEx,  
    KVHTMLTOCOptions   *pTOCCreateOptions,  
    BOOL                bIndex,  
    KVErrCode          *pError)
```

Arguments

<code>pContext</code>	A pointer returned from fplnit() or fplnitWithLicenseData() .
<code>pCallingContext</code>	A pointer passed back to the callback functions.
<code>pInFileName</code>	A pointer to the input file.
<code>pOutFileName</code>	A pointer to the output file.
<code>pTemplatesEx</code>	<p>A pointer to the <code>KVHTMLTemplateEx</code> data structure. It defines the overall structure of the output. Individual elements within the structure define the markup written at specific points in the output stream. See KVHTMLTemplateEx, on page 246.</p> <p>If this pointer is <code>NULL</code>, the default values for the structure are used.</p>
<code>pOptionsEx</code>	<p>A pointer to the <code>KVHTMLOptionsEx</code> data structure. It defines the options that control the markup written in response to the general style and attributes (font, color, and so on) of the document. See KVHTMLOptionsEx, on page 237.</p> <p>If this pointer is <code>NULL</code>, the default values for the structure are used.</p>
<code>pCallbacksEx</code>	<p>A pointer to the <code>KVHTMLCallbacksEx</code> data structure. It is a structure of functions that Export calls for specific, user-defined purposes. See KVHTMLCallbacksEx, on page 228.</p> <p>If you do not use callbacks, this can be <code>NULL</code>. Only the <code>Continue()</code> callback can be used with <code>KVHTMLConvertFile()</code>.</p>
<code>pTOCCreateOptions</code>	<p>A pointer to the <code>KVHTMLTOCOptions</code> data structure. It specifies whether a heading is included in the table of contents. See KVHTMLTOCOptions, on page 250.</p> <p>If this pointer is <code>NULL</code>, the default values for the structure are used.</p>
<code>bIndex</code>	<p>Set this to <code>TRUE</code> to generate output with minimal markup and without images. Because the generated output is minimized to textual content, it is suitable for an indexing engine. If you set <code>bIndex</code> to <code>FALSE</code>, embedded images in a document are regenerated as separate files and stored in the output directory.</p> <p>You can also set this through the bNoPictures, on page 244 member in the template files.</p>
<code>pError</code>	A pointer to an error code if the call to <code>KVHTMLConvertFile()</code> fails.

Returns

- If the call is successful, the return value is `TRUE`.
- If the call is unsuccessful, the return value is `FALSE`.

Discussion

- Only pContext, pInFileName, pOutFileName, and bIndex are required. All other pointers should be NULL when they are not set.
- If pCallbacksEx is NULL, pOptionsEx->pszDefaultOutputDirectory must be valid, except when you set bIndex to TRUE.
- This function runs in-process or out of process. See [Convert Files Out of Process, on page 31](#).
- When converting out of process, this function must be called after the call to KVHTMLStartOOPSession() and before the call to KVHTMLEndOOPSession(). See [KVHTMLStartOOPSession\(\), on page 205](#) and [KVHTMLEndOOPSession\(\), below](#).
- When converting out of process, the values for the KVHTMLTemplateEx, KVHTMLOptionsEx, and KVHTMLTOCOptions structures should be set to NULL. These structures are already passed in the call to KVHTMLStartOOPSession(). See [KVHTMLStartOOPSession\(\), on page 205](#).

Example

```
if(!(*KVHTMLInt.KVHTMLConvertFile)(
    pKVHTML,          /* A pointer returned by fpInit() */
    NULL,             /* A pointer for callback functions */
    &InputFile,       /* Input file */
    &OutputFile,      /* Output file */
    &HTMLTemplates,  /* Markup and related variables */
    &HTMLOptions,     /* Options */
    NULL,             /* A pointer to callback functions */
    NULL,             /* TOC options */
    FALSE,           /* Index mode */
    &error))         /* The error return value */
{
    printf("Error converting %s to HTML %d\n", argv[i - 1], error);
}
else
{
    printf("Conversion of %s to HTML completed.\n\n", argv[i - 1]);
}
```

KVHTMLEndOOPSession()

This function terminates the current out-of-process conversion session, and releases the source data and resources related to the session.

Syntax

```
BOOL pascal KVHTMLEndOOPSession(  
    void          *pContext,  
    BOOL          bKeepServantAlive,  
    KVErrCodeEx  *pError  
    DWORD        dwOptions,  
    void          *pReserved1,  
    void          *pReserved2 );
```

Arguments

<code>pContext</code>	A pointer returned from <code>fplnit()</code> or <code>fplnitWithLicenseData()</code> .
<code>bKeepServantAlive</code>	Set this to TRUE to keep a Servant process active after the Export out-of-process session is terminated. If the Servant remains active, subsequent conversion requests are processed more quickly because the Servant is already prepared to receive data. Set this to FALSE to terminate the Export out-of-process session and the associated Servant process.
<code>pError</code>	A pointer to an error code defined in <code>KVErrCodeEx</code> in <code>kverrorcodes.h</code> .
<code>dwOptions</code>	Reserved for future use.
<code>pReserved1</code>	Reserved for future use.
<code>pReserved2</code>	Reserved for future use.

Returns

- If the call is successful, the return value is **TRUE**.
- If the call is unsuccessful, the return value is **FALSE**.

Example

The following sample code is from the `cnv2htmlloop` sample program:

```
/* declare endsession function pointer */  
BOOL (pascal *fpKVHTMLEndOOPSession)( void *,  
    BOOL          ,  
    KVErrCode     *,  
    DWORD        ,  
    void          *,  
    void          *);
```

```
/* assign OOP endsession function pointer */
fpKVHTMLEndOOPSession = (BOOL (pascal *) ( void *,
    BOOL ,
    KVErrorCode *,
    DWORD ,
    void *,
    void * ))mpGetProcAddress(hKVHTML,
"KVHTMLEndOOPSession");
if(!fpKVHTMLEndOOPSession)
{
    printf("Error assigning KVHTMLEndOOPSession() pointer\n");
    (*KVHTMLInt.fpFileToInputStreamFree)(pKVHTML, &Input);
    (*KVHTMLInt.fpFileToOutputStreamFree)(pKVHTML, &Output);
    mpFreeLibrary(hKVHTML);
    return 8;
}
/*****END OOP SESSION, DO NOT KEEP SERVANT ALIVE *****/
if(!(*fpKVHTMLEndOOPSession)(pKVHTML,
    FALSE,
    &error,
    0,
    NULL,
    NULL))
{
    printf("Error calling fpKVHTMLEndOOPSession \n");
    (*KVHTMLInt.fpFileToInputStreamFree)(pKVHTML, &Input);
    (*KVHTMLInt.fpFileToOutputStreamFree)(pKVHTML, &Output);
    (*KVHTMLInt.fpShutdown)(pKVHTML);
    mpFreeLibrary(hKVHTML);
    return 10;
}
```

KVHTMLSetHighlight()

This function is called directly and enables you to specify search terms that are found and highlighted in the HTML output. See [Search and Highlight Terms, on page 91](#). The `htmlini` sample program demonstrates this function. See [htmlini, on page 129](#).

Syntax

```
int pascal_export KVHTMLSetHighlight(
    void *pContext,
    KVHTMLHighlight *pHLConfig,
    void *pReserved1,
    void *pReserved2 );
```

Arguments

- `pContext` A pointer returned from [fplnit\(\)](#) or [fplnitWithLicenseData\(\)](#).
- `pHLConfig` A pointer to the `KVHTMLHighlight` data structure. This structure defines the terms to be found and the highlight format applied. See [KVHTMLHighlight](#), on page 231.
- `pReserved1` Reserved for future use.
- `pReserved2` Reserved for future use.

Returns

- If the call is successful, the return value is `KVERR_Success`.
- If the call is unsuccessful, the return value is an error code.

Discussion

- This function must be called after the call to [fplnit\(\)](#) or [fplnitWithLicenseData\(\)](#) and before the call to [fpConvertStream\(\)](#) or [KVHTMLConvertFile\(\)](#).
- When converting out of process, this function must be called before the call to [KVHTMLStartOOPSession\(\)](#). See [Convert Files Out of Process](#), on page 31.

Example

```
KVHTMLHighlight    HTMLHighlight;
int (pascal *fpHTMLSetHighlight)(void *, KVHTMLHighlight *, void *, void *);
//get function pointer and call the function
fpHTMLSetHighlight = (int (pascal *)
    (void *, KVHTMLHighlight *, void *, void*))myGetProcAddress(hKVHTML,
"KVHTMLSetHighlight");
    if(!fpHTMLSetHighlight)
    {
        printf("Error accessing HTMLSetHighlight().\n");
    }
    else
    {
        if(KVERR_Success != (*fpHTMLSetHighlight)(pKVHTML, &HTMLHighlight, NULL,
NULL))
        {
            printf("Error setting HTML highlight.\n");
        }
    }
```

```
}  
}
```

KVHTMLSetStyleSheet()

This function is called directly and is used to specify the full path and file name of an external Cascading Style Sheet (CSS).

NOTE: You cannot retrieve the CSS if you have set `bNoPictures` to **TRUE** (see [KVHTMLOptionsEx](#), on page 237).

Syntax

```
BOOL pascal KVHTMLSetStyleSheet(  
    void *pContext,  
    char *pszStyleSheetName,  
    char *pszRef);
```

Arguments

<code>pContext</code>	A pointer returned from fplnit() or fplnitWithLicenseData() .
<code>pszStyleSheetName</code>	A pointer to the full path and file name of the style sheet.
<code>pszUr1Ref</code>	A pointer to the URL or file name of style sheet.

Returns

- If the call is successful, the return value is `TRUE`.
- If this call is unsuccessful, the return value is `FALSE`.

Discussion

- When the value for `eStyleSheetType` in `KVHTMLOptionsEx` is set to `CSS_TOFILE`, and the token `$STYLESHEET` is specified in the templates, an external CSS file is referenced in the output HTML by a `LINK` statement of the form:

```
<LINK rel="STYLESHEET" href="pszRef" type="text/css">
```

- If the name of the style sheet is not specified by using this function, a style sheet file is created with an automatically generated file name.

- If this function is used to specify the name of the style sheet file, that file name is used in the conversion.
 - If the file does not exist in the specified location, it is created.
 - If the file exists, but is empty, CSS styles are written to the file.
 - If the file exists and is not empty, the conversion attempts to use the predefined styles, and appends any new styles that are required for the conversion.
- If the value for `pszStyleSheetName` includes the output directory, the `href` only consists of the file name because the HTML output resides in the same directory as the CSS file.
- If the value for `pszStyleSheetName` points to a directory other than the output directory, the `href` consists of the full path and file name.
- If the value for `pszStyleSheetName` points to a file that is not a CSS file or to a non-existent directory, the LINK statement is written; but, the style sheet information is added inline (`CSS_INLINE`), and an external CSS file is not generated.
- If there are multiple calls made to `fpConvertStream()` or `KVHTMLConvertFile()`, and the name of the style sheet is set with `KVHTMLSetStyleSheet`, the file name can be disabled by calling `KVHTMLSetStyleSheet` again with the `pszStyleSheetName` and `pszRef` set to `NULL`. The file name can then be set to a different value by calling `KVHTMLSetStyleSheet` with the new file name prior to the next call to `fpConvertStream()` or `KVHTMLConvertFile()`.
- This function runs in-process or out of process. See [Convert Files Out of Process, on page 31](#).
- When converting out of process, this function must be called after the call to `KVHTMLStartOOPSession()` and before the call to `KVHTMLEndOOPSession()`. See [KVHTMLStartOOPSession\(\), below](#) and [KVHTMLEndOOPSession\(\), on page 200](#).

KVHTMLStartOOPSession()

This function performs the following:

- Initializes the out-of-process session.
- Specifies the input stream or file.
- Passes conversion options from the `KVHTMLTemplateEx`, `KVHTMLOptionsEx`, and `KVHTMLTOOptions` data structures.
- Creates a Servant process.
- Establishes a communication channel between the application thread and the Servant.
- Sends the data to the Servant.

Syntax

```
BOOL pascal KVHTMLStartOOPSession(  
    void *pContext,
```

```
KVInputStream      *pInputStream,  
char              *pFileName,  
KVHTMLTemplateEx *pTemplatesEx,  
KVHTMLOptionsEx  *pOptionsEx,  
KVHTMLTOCOptions *pTOCCreateOptions  
DWORD            *pPID,  
KVErrCode        *pError  
DWORD            dwOptions,  
void             *pReserved1,  
void             *pReserved2 );
```

Arguments

<code>pContext</code>	A pointer returned from fplnit() or fplnitWithLicenseData() .
<code>pInputStream</code>	<p>A pointer to the developer-assigned instance of <code>KVInputStream</code>. The <code>KVInputStream</code> structure defines the input stream containing the source for the conversion.</p> <p>If <code>pInput</code> is defined, then <code>pFileName</code> must be <code>NULL</code>. The input data can be defined as a data stream or file, but not both.</p>
<code>pFileName</code>	<p>A pointer to the file to be converted. The file must exist on the same file system as the Servant.</p> <p>If <code>pFileName</code> is defined, then <code>pInput</code> must be <code>NULL</code>. The input data can be defined as a data stream or file, but not both.</p>
<code>pTemplatesEx</code>	<p>A pointer to the <code>KVHTMLTemplateEx</code> data structure. It defines the overall structure of the output. Individual elements within the structure define the markup written at specific points in the output stream. See KVHTMLTemplateEx, on page 246.</p> <p>If this pointer is <code>NULL</code>, the default values for the structure are used.</p>
<code>pOptionsEx</code>	<p>A pointer to the <code>KVHTMLOptionsEx</code> data structure. It defines the options that control the markup written in response to the general style and attributes (font, color, and so on) of the document. See KVHTMLOptionsEx, on page 237.</p> <p>If this pointer is <code>NULL</code>, the default values for the structure are used.</p>
<code>pTOCCreateOptions</code>	<p>A pointer to the <code>KVHTMLTOCOptions</code> data structure. It specifies whether a heading is included in the table of contents. See KVHTMLTOCOptions, on page 250.</p> <p>If this pointer is <code>NULL</code>, the default values for the structure are used.</p>
<code>pPID</code>	Address of a <code>DWORD</code> into which the Servant process ID is returned.
<code>pError</code>	A pointer to an error code defined in <code>KVErrCode</code> in <code>kverrorcodes.h</code> .
<code>dwOptions</code>	Reserved for future use.

pReserved1 Reserved for future use.
pReserved2 Reserved for future use.

Returns

If the call is successful, the return value is TRUE.

If the call is unsuccessful, the return value is FALSE.

Discussion

- After the out-of-process session is started successfully, all conversion functions can be called. The data is then processed on the Servant until the session is terminated by a call to [KVHTMLEndOOPSession\(\)](#), on page 200.
- All functions that can run out of process must be called within the out-of-process session, that is, after the call to [KVHTMLStartOOPSession\(\)](#), and before the call to [KVHTMLEndOOPSession\(\)](#).
- The [KVHTMLConvertFile\(\)](#) function can only be called once in a single out-of-process session.
- Since the [KVHTMLTemplateEx](#), [KVHTMLOptionsEx](#), and [KVHTMLTOCOptions](#) data structures are passed by this function, the same pointers in the call to [KVHTMLConvertFile\(\)](#) are ignored.

Example

The following sample code is from the `cnv2htmlloop` sample program:

```
/* declare OOP startsession function pointer */
BOOL (pascal *fpKVHTMLStartOOPSession)( void       *,
          KVInputStream       *,
          char                *,
          KVHTMLTemplateEx   *,
          KVHTMLOptionsEx    *,
          KVHTMLTOCOptions   *,
          DWORD               *,
          KVErrCode          *,
          DWORD               *,
          void                *,
          void                * );

/* assign OOP startsession function pointer */
fpKVHTMLStartOOPSession = (BOOL (pascal *)( void       *,
          KVInputStream       *,
          char                *,
          KVHTMLTemplateEx   *,
          KVHTMLOptionsEx    *,
          KVHTMLTOCOptions   *,
          DWORD               *,
          KVErrCode          *,
          DWORD               *,
          void                *,
          void                * )
```

```

        DWORD          ,
        void           *,
        void           * ))mpGetProcAddress(hKVHTML,
"KVHTMLStartOOPSession");
if(!fpKVHTMLStartOOPSession)
{
    printf("Error assigning KVHTMLStartOOPSession() pointer\n");
    (*KVHTMLInt.fpFileToInputStreamFree)(pKVHTML, &Input);
    (*KVHTMLInt.fpFileToOutputStreamFree)(pKVHTML, &Output);
    mpFreeLibrary(hKVHTML);
    return 7;
}
/*****START OOP SESSION *****/
if(!(*fpKVHTMLStartOOPSession)(pKVHTML,
    &Input,
    NULL,
    &HTMLTemplates,      /* Markup and related variables */
    &HTMLOptions,        /* Options */
    NULL,                /* TOC options */
    &oopServantPID,
    &error,
    0,
    NULL,
    NULL))
{
    printf("Error calling fpKVHTMLStartOOPSession \n");
    (*KVHTMLInt.fpFileToInputStreamFree)(pKVHTML, &Input);
    (*KVHTMLInt.fpFileToOutputStreamFree)(pKVHTML, &Output);
    (*KVHTMLInt.fpShutdown)(pKVHTML);
    mpFreeLibrary(hKVHTML);
    return 9;
}

```

Chapter 9: HTML Export API Callback Functions

This section describes the HTML Export API callback functions.

- [Introduction](#) 209
- [Continue\(\)](#) 209
- [GetAnchor\(\)](#) 210
- [GetAuxOutput\(\)](#) 212
- [UserCB\(\)](#) 213

Introduction

The `fpConvertStream()` and `KVHTMLConvertFile()` functions enable you to specify a callback function. A callback function controls the conversion while it is in progress. For example, you can specify a callback function to report progress during the conversion.

To use the API callback functions, declare one or more instances of the `KVHTMLCallbacksEx` structure. Each member of this instance can then be initialized by assigning a function pointer to the application-defined callback functions, cast to the appropriate function prototype. Each instance of `KVHTMLCallbacksEx` can define unique callback functions. Alternatively, the functions can be common to all instances of `KVHTMLCallbacksEx`; these functions take appropriate action, depending on the value of the pointer `pCallingContext`.

The second parameter (`pCallingContext`) of the call to `fpConvertStream()` and `KVHTMLConvertFile()` provides a void pointer used to identify the context of this call. If more than one call to `fpConvertStream()` or `KVHTMLConvertFile()` is made within a single application, any resulting callbacks are identified by the first parameter of the callback function. This enables the callback function to take any appropriate action, depending on which calling context is returned.

The seventh parameter (`pCallbacks`) of the call to `fpConvertStream()` and `KVHTMLConvertFile()` must be set to the address of the `KVHTMLCallbacksEx` structure to be used for this call.

For sample code, see the sample program `callback.c`. It creates a frame-based HTML stream and demonstrates the use of the callback functions.

Continue()

When `fpConvertStream()` or `KVHTMLConvertFile()` is called, control is not returned to the application until the entire document is processed. This callback function provides a means of monitoring progress and terminating the conversion process before the conversion is completed.

Syntax

```
BOOL (pascal *Continue) (  
    void *pCallingContext,  
    int nPercentComplete);
```

Arguments

- pCallingContext** A pointer passed back to the caller-provided callback functions. This pointer, which can be NULL, is specified as the second parameter of the call to `fpConvertStream()` and `KVHTMLConvertFile()`.
- nPercentComplete** The approximate percentage of the current conversion that is completed. You can monitor the progress of the conversion by checking this value, which indicates the percentage of blocks that have been processed.

Returns

- To continue the conversion, return TRUE.
- To terminate the conversion process without completing the conversion, return FALSE.

Discussion

- There is a callback to this function for every entry that appears in the generated table of contents.
- The application is free to execute any required code in the callback function, with the exception of `fpShutDown()`.

GetAnchor()

This function should provide the anchor name used for external graphics referenced with `` tags, heading-level table of contents entries, and external files (such as CSS files and revision summary files).

The anchor name you provide is passed into [GetAuxOutput\(\)](#), on page 212 to identify the output stream if defined, otherwise it is used as the auxiliary file name.

Syntax

```
BOOL (pascal *GetAnchor) (  
    void *pCallingContext,  
    KVHTMLXMLAnchorTypeEx eAnchorTypeEx,  
    char *pszAnchor,  
    int cbAnchorMax,  
    BYTE *pcHTML,  
    UINT cbHTML);
```

Arguments

<code>pCallingContext</code>	A pointer that gets passed back to the caller-provided callback functions. This pointer, which can be NULL, is specified as the second parameter of the call to <code>fpConvertStream()</code> .
<code>eAnchorTypeEx</code>	The anchor type for the output stream. It must be one of the enumerated types defined in <code>KVHTMLAnchorTypeEx</code> .
<code>pszAnchor</code>	A pointer to the memory that you should write the new anchor to.
<code>cbAnchorMax</code>	The maximum number of bytes to place in <code>pszAnchor</code> .
<code>pcHTML</code>	KeyView will have set this to either NULL or a pointer to one of the following: <ul style="list-style-type: none">• markup defining the contents of a table of contents entry• the external graphic file name• the external file name
<code>cbHTML</code>	The number of valid bytes in <code>pcHTML</code> .

Returns

- To continue the conversion, return TRUE.
- To terminate the conversion process without completing the conversion, return FALSE.

Discussion

- If this callback is NULL, default anchor names are generated. The generated names are unique across the document.
- This function is called once per block, block chunk, graphic anchor, or extra file. Any required code can be executed here as long as a unique value for `pszAnchor` is assigned. If this string is not unique, an existing file might be overwritten, producing undesirable results. The callback

function should contain the functionality to verify whether files already exist.

- This function can call the [fpGetAnchor\(\)](#), on page 178 interface function, which returns the default anchor generated by Export. For example, to specify only graphic anchor names, provide an anchor when eAnchorTypeEx is VectorPictureAnchorEx or RasterPictureAnchorEx. For all other anchor types, call fpGetAnchor() with the same parameters you were passed.
- pszAnchor must be assigned. It can be derived from the cbAnchorMax, pchTML, and cbHTML values, which are also provided.
- pchTML can be null if the graphic is an internal part of the document.

GetAuxOutput()

This callback function enables the calling application to specify an auxiliary output stream for a block or graphic.

Syntax

```
BOOL (pascal *GetAuxOutput) (  
    void *pCallingContext,  
    KVHTMLXMLAnchorTypeEx eAnchorTypeEx,  
    char *pszAnchor,  
    KVOutputStream *pNewOutput);
```

Arguments

- | | |
|-----------------|--|
| pCallingContext | A pointer passed back to the caller-provided callback functions. This pointer, which can be NULL, is specified as the second parameter of the call to fpConvertStream(). |
| eAnchorTypeEx | A graphic or block anchor as defined by the enumerated types in KVHTMLAnchorTypeEx. |
| pszAnchor | KeyView will have set this to the anchor associated with this stream. pszAnchor is based on the call to GetAnchor(). |
| pNewOutput | A pointer to a KVOutputStream structure that can be used to write data to the current block. |

Returns

- To continue the conversion, return TRUE.
- To terminate the conversion process without completing the conversion, return FALSE.

Discussion

- If `GetAuxOutput()` is `NULL`, the `pszDefaultOutputDirectory` member of the instance of `KVHTMLOptionsEx` is used as the base storage location for auxiliary output files. If `pszDefaultOutputDirectory` is also `NULL`, auxiliary files are placed in the current working directory.
- This function must fill out the provided stream function by setting an appropriate function for each member. Memory allocated to the I/O structure must be tracked and freed within the call to `Close()`.

UserCBO

This callback function is triggered by including the `$USERCB` token in a member of `KVHTMLTemplateEx`. For example, placing "`$USERCB=my_callback` " in `pszFirstH1Start` results in a callback at the point when `pszFirstH1Start` is processed. The user callback function is identified by the text assigned to `$USERCB`, which in this example is `my_callback`. This identifier is passed to the argument `pszUserCBid`.

Syntax

```
BOOL (pascal *UserCB) (  
    void          *pCallingContext,  
    char          *pszUserCBid,  
    KVOutputStream *pNewOutput  
    void          *pReserved);
```

Arguments

<code>pCallingContext</code>	A pointer that gets passed back to the caller-provided callback function. This pointer, which can be <code>NULL</code> , is specified as the second parameter of the call to <code>fpConvertStream()</code> .
<code>pszUserCBid</code>	A pointer to a string that identifies the source of the callback. The identifier must be delimited by a trailing white space. For example, " <code>my_callback</code> ".
<code>pNewOutput</code>	A pointer to a <code>KVOutputStream</code> structure that can be used to write data to the current block.
<code>pReserved</code>	Reserved for future use.

Returns

- To continue the conversion, return TRUE.
- To terminate the conversion process without completing the conversion, return FALSE.

Chapter 10: HTML Export

API Structures

This section provides information on the structures used by the HTML Export API. These structures are defined in `kvhtml.h`, `kvtypes.h`, and `adinfo.h`.

• <code>ADDOCINFO</code>	216
• <code>KVInputStream</code>	216
• <code>KVMemoryStream</code>	217
• <code>KVOutputStream</code>	218
• <code>KVPartitionDimensions</code>	218
• <code>KVPartitionInfo</code>	219
• <code>KVPartitionInfoList</code>	220
• <code>KVPartitionSetOn</code>	221
• <code>KVRMSCredentials</code>	221
• <code>KVSTR</code>	222
• <code>KVStreamInfo</code>	223
• <code>KVStructHead</code>	224
• <code>KVStyle</code>	224
• <code>KVSumInfoElemEx</code>	226
• <code>KVSummaryInfoEx</code>	226
• <code>KVXConfigInfo</code>	227
• <code>KVHTMLCallbacksEx</code>	228
• <code>KVHTMLHeadingInfo</code>	229
• <code>KVHTMLHighlight</code>	231
• <code>KVHTMLInterfaceEx</code>	232
• <code>KVHTMLInterfaceEx2</code>	234
• <code>KVHTMLOptionsEx</code>	237
• <code>KVHTMLTemplateEx</code>	246
• <code>KVHTMLTOCOptions</code>	250
• <code>KVRevisionMark</code>	252
• <code>KV_RM_Title</code>	253

ADDOCINFO

This structure provides the format, file class, and version number of the source document. It is defined in `adinfo.h`, and is initialized by calling the `fpGetStreamInfo()` function. See [fpGetStreamInfo\(\)](#), on page 182.

```
typedef struct
{
    ENdocClass      eClass;
    ENdocFmt        eFormat;
    long            lVersion;
    unsigned long   ulAttributes;
}
ADDOCINFO, *ADDOCINFOPTR;
```

Member Descriptions

<code>eClass</code>	The file class of the source document (for example, spreadsheet, word processor, or encapsulation format) as defined by the <code>ENdocClass</code> enumerated type in <code>adinfo.h</code> .
<code>eFormat</code>	The major format of the source document (such as Microsoft Word or Corel Presentation) as defined by the <code>ENdocFmt</code> enumerated type in <code>adinfo.h</code> .
<code>lVersion</code>	The version number of the file format. The number is multiplied by 1000. For example, 1.02 is represented by 1020.
<code>ulAttributes</code>	Other attributes of the document as defined by the ENDocAttributes , on page 256 enumerated type in <code>adinfo.h</code> .

Discussion

When format detection is enhanced in future releases, new format IDs might be added to the `ENdocFmt` enumerated type. When you use this type, your code should ensure binary compatibility with future releases. For example, if you use an array to access format information based on a format ID, your code should check that the format ID is less than `Max_Fmt` before accessing the data. This ensures that new format codes are detected when you add KeyView binary files from new releases to your existing installation.

KVInputStream

This structure defines an input stream for the HTML conversion. The structure is defined in `kvstream.h`.

```
typedef struct tag_InputStream
{
    void *pInputStreamPrivateData;
    long lcbFileSize;
    BOOL (pascal *fpOpen) (struct tag_InputStream *);
    UINT (pascal *fpRead) (struct tag_InputStream *, BYTE *, UINT);
    BOOL (pascal *fpSeek) (struct tag_InputStream *, long, int);
    long (pascal *fpTell) (struct tag_InputStream *);
    BOOL (pascal *fpClose)(struct tag_InputStream *);
}
KVInputStream;
```

Member Descriptions

All member functions are equivalent to their counterparts in the ANSI standard library, except `fpOpen()`, which returns `FALSE` on failure. On `fpOpen()`, if the size of the stream is known, assign that value to `lcbFileSize`. Otherwise, set `lcbFileSize` to `0`.

KVMemoryStream

This structure defines an optional memory allocator to be used by HTML Export. It is initialized by calling [fplnit\(\)](#) or [fplnitWithLicenseData\(\)](#).

```
typedef struct tag_MemoryStream
{
    void *pMemoryStreamPrivateData;
    void * (pascal *fpMalloc)(struct tag_MemoryStream*,size_t);
    void (pascal *fpFree) (struct tag_MemoryStream*, void *);
    void * (pascal *fpRealloc)(struct tag_MemoryStream*,void *, size_t);
    void * (pascal *fpCalloc)(struct tag_MemoryStream*, size_t, size_t);
}
KVMemoryStream;
```

Member Descriptions

All member functions are equivalent to their counterparts in the ANSI standard library.

Discussion

- `fpRealloc()` must handle a `NULL` pointer.
- For systems that do not support `fpRealloc()`, refer to the `callback` sample program, which demonstrates how to use the memory management features.
- If `KVMemoryStream` is not provided, the default C run-time memory allocation is used.

KVOutputStream

This structure defines an output stream for the HTML conversion. The structure is defined in `kvstream.h`.

```
typedef struct tag_OutputStream
{
    void *pOutputStreamPrivateData;
    BOOL (pascal *fpCreate)(struct tag_OutputStream *,TCHAR *);
    UINT (pascal *fpWrite) (struct tag_OutputStream *, BYTE *, UINT);
    BOOL (pascal *fpSeek) (struct tag_OutputStream *, long, int);
    long (pascal *fpTell) (struct tag_OutputStream *);
    BOOL (pascal *fpClose) (struct tag_OutputStream *);
}
KVOutputStream;
```

Member Descriptions

All member functions are equivalent to their counterparts in the ANSI standard library.

KVPartitionDimensions

This structure contains the dimensions of a partition. This structure is defined in `kvpartition.h`.

```
typedef struct tag_KVPartitionDimensions
{
    KVStructHeader;
    //These values are in pixels
    int width;
    int height;
    int left_margin;
    int right_margin;
    int top_margin;
    int bottom_margin;
}
KVPartitionDimensions;
```

Member Descriptions

KVStructHeader	The KeyView version of the structure. See KVStructHead , on page 224.
----------------	---

width	The partition width in pixels.
height	The partition height in pixels.
left_margin	The partition left margin in pixels.
right_margin	The partition right margin in pixels.
top_margin	The partition top margin in pixels.
bottom_margin	The partition bottom margin in pixels.

Discussion

The pixel values use the CSS definition of a pixel (that is, 1/96 inch).

The dimensions are derived from the values stored in the processed document, and can be zero if no values were stored. In particular:

- Documents that were converted by using the spreadsheet structured access layer never produce partitions with dimension information.
- Documents that were converted by using the presentation graphic structured access layer never produce partitions with margins.

For documents that were converted by using the word processing structured access layer, this structure gives the page height that the document specifies. Export does not support partitioning at soft page breaks, and therefore it is unlikely that the height of the converted document will match the reported height. You can use the reported height to ensure that partitions do not display with a smaller height than native pages.

KVPartitionInfo

This structure defines the individual partition information objects. This structure is defined in `kvpartition.h`.

```
typedef struct tag_KVPartitionInfoList
{
    KVStructHeader;
    const char* anchor;
    KVPartitionStartReason startReason;
    KVPartitionDimensions dimensions;
    const char* backgroundColor;
}
KVPartitionInfo;
```

Member Descriptions

KVStructHeader	The KeyView version of the structure. See KVStructHead .
anchor	The anchor name corresponding to the file or stream this partition was written to.
startReason	The reason this partition was created. The reasons are defined in the KVPartitionStartReason enum in <code>kvpartition.h</code> .
dimensions	The dimensions of the partition, given as a KVPartitionDimensions structure.
backgroundColor	The background color of the partition, as a hex code of the form #RRGGBB. If KeyView does not find background color information in the source document, this value is NULL.

KVPartitionInfoList

This structure provides a count of the number of partitions, and a pointer to the first partition of the array of individual partitions. You fill out the structure by calling the `fpGetPartitionInfoList()` function. See [fpGetPartitionInfoList](#), on page 181.

This structure is defined in `kvpartition.h`.

```
typedef struct tag_KVPartitionInfoList
{
    KVStructHeader;
    KVPartitionInfo* partitionInfoList;
    int partitionInfoListLength;
}
KVPartitionInfoList;
```

Member Descriptions

KVStructHeader	The KeyView version of the structure. See KVStructHead , on page 224.
partitionInfoList	Points to the first element of the array of partition information objects, defined by the KVPartitionInfo structure.
partitionInfoListLength	The number of partitions contained in the array.

KVPartitionSetOn

This structure defines the reason for creating a new partition. This structure is defined in `kvpartition.h`.

```
typedef struct tag_KVPartitionSetOn
{
    KVStructHeader;
    BOOL formatStandard;
    BOOL headings;
    BOOL hardBreaks;
    BOOL pageSizeChange;
}
KVPartitionSetOn;
```

Member Descriptions

<code>KVStructHeader</code>	The KeyView version of the structure. Before you initialize the <code>KVPartitionSetOn</code> structure, use the macro <code>KVStructInit</code> to initialize the <code>KVStructHead</code> structure. See KVStructHead .
<code>formatStandard</code>	The format standard start reason. For more information, see Partitioning, on page 119 .
<code>headings</code>	A heading in a Word Processing document.
<code>hardBreaks</code>	A hard page break in a Word Processing document.
<code>pageSizeChange</code>	A page size change in a Word Processing document.

NOTE: You can also partition documents into evenly sized blocks, but you do not configure that in `KVPartitionSetOn`. See [KVHTMLTemplateEx, on page 246](#).

KVRMSCredentials

This structure defines each element of the RMS credentials. This structure is defined in `kvdecryptionsettings.h`.

```
typedef struct _KVRMSCredentials
{
    KVStructHeader;

    const char* tenantID;
```

```
    const char* clientID;  
    const char* clientSecret;  
}  
KVRMSCredentials;
```

Member Descriptions

KVStructHeader	The KeyView version of the structure. See KVStructHead , on page 224.
tenantID	The tenant ID of the domain.
clientID	The client ID of the application.
clientSecret	The client secret for the application.

For KeyView to access the protected contents of Microsoft Azure Rights Management System (RMS) protected files, your end-user application must be registered on the relevant Azure domain. For more information about how to register an app, refer to the Microsoft documentation: <https://docs.microsoft.com/en-us/azure/active-directory/develop/quickstart-register-app>.

After you register an application, you can find the client and tenant IDs in the Azure Portal, in the Overview section. You can find the client secret in the Certificates & Secrets section.

CAUTION: This information is linked to the domain itself, rather than to a specific user. Providing this information allows KeyView to access the contents of all files protected by this domain. Therefore you must handle these three pieces of information securely.

KVSTR

This structure is used to identify string types (string text and byte count) for the first three members of KVStyle. See [KVStyle](#), on page 224.

```
typedef struct tag_KVSTR  
{  
    char    *pcString;  
    int     cbString;  
}  
KVSTR;
```

Member Descriptions

`pcString` A text string.

`cbString` The length of `pcString`, excluding the terminating NULL(s). This allows UNICODE or double bytes to be employed.

KVStreamInfo

This structure defines a document's character set and format. It is initialized by calling `fpGetStreamInfo()`. See [fpGetStreamInfo\(\)](#), on page 182.

```
typedef struct tag_KVStreamInfo
{
    KVCharSet    charset;
    ADDOCINFO    adInfo;
}
KVStreamInfo;
```

Member Descriptions

`charset` The character set of the source document, if that information is ascertainable. The available character sets are enumerated in `KVCharSet` in `kvcharset.h`. See [Convert Character Sets](#), on page 83.

`adInfo` The file class, major format, and version of the source document. A pointer to the `ADDOCINFO` structure. The structure of `ADDOCINFO` is defined in `adinfo.h`. See [ADDOCINFO](#), on page 216.

- `adInfo.eClass` represents the class of the source document, as defined by the `ENdocClass` enumerated type.
- `adInfo.eFormat` represents the format of the source document, as defined by the `ENdocFmt` enumerated type.
- `adInfo.lVersion` represents the version number of the file format. The number is multiplied by 1000. For example, 1.02 is represented by 1020.
- `adInfo.ulAttributes` represents other attributes of the document as defined by the `ENdocAttributes` enumerated type.

Discussion

When format detection is enhanced in future releases, new format IDs might be added to the `ENdocFmt` enumerated type. When you use this type, your code should ensure binary compatibility with future

releases. For example, if you use an array to access format information based on a format ID, your code should check the format ID is less than `Max_Fmt` before accessing the data. This ensures that new format codes are detected when you add KeyView binary files from new releases to your existing installation.

KVStructHead

This structure contains the current KeyView version number and is the first member of other structures. It enables Micro Focus to modify the structures in future releases, but to maintain backward compatibility. Before initializing a structure that contains the `KVStructHead` structure, use the macro `KVStructInit` to initialize it as illustrated in the example below. You do not need to set any of the members of `KVStructHead` because this is handled by `KVStructInit`. The structure and macro are defined in `kvstructhead.h`.

```
typedef struct _KVStructHead
{
    WORD    version;
    WORD    size;
    DWORD   reserved;
    void    *internal;
} KVStructHeadRec, *KVStructHead;
```

Member Descriptions

<code>version</code>	The current KeyView version number. This is a symbolic constant (<code>KeyviewVersion</code>) defined in <code>kvtypes.h</code> . This constant is updated for each KeyView release.
<code>size</code>	The size of the <code>KVStructHeadRec</code> structure.
<code>reserved</code>	Reserved for internal use.
<code>internal</code>	Reserved for internal use.

Example

```
KVOpenFileArgRec openArg;
KVStructInit(&openArg);
```

KVStyle

This structure defines the style mapping support for `KVSTR`-defined styles. The first three members of `KVStyle` are `KVSTR` structures (see [KVSTR](#), on page 222). Each `KVSTR` structure contains the text

string and byte count for `StyleName`, `MarkupStart`, and `MarkupEnd`. The structure is initialized by calling the function `fpSetStyleMapping()`.

See [fpSetStyleMapping\(\), on page 188](#) and [Map Styles, on page 87](#).

HTML Export supports both paragraph styles and character styles. It works on the assumption that each style has a unique name. Only one paragraph style can be active at one time; therefore, the opening of a new paragraph style automatically closes the previous paragraph style. By contrast, several character styles can be active at once. When HTML Export receives an `EndCharStyle` token from the format parser, the most recent character style is terminated.

```
typedef struct tag_KVStyles
{
    KVSTR    StyleName;
    KVSTR    MarkupStart;
    KVSTR    MarkupEnd;
    DWORD    dwFlags;
}
KVStyle;
```

Member Descriptions

<code>StyleName</code>	The name of the word processing style (for example, "Heading 1") to which style mapping applies. A pointer to the <code>KVSTR</code> structure. See KVSTR, on page 222 . Style names are case sensitive.
<code>MarkupStart</code>	The markup added to the beginning of a paragraph or character style. A pointer to the <code>KVSTR</code> structure. See KVSTR, on page 222 .
<code>MarkupEnd</code>	The markup added to the end of a paragraph or character style. A pointer to the <code>KVSTR</code> structure. See KVSTR, on page 222 .
<code>dwFlags</code>	Instructions on how to process the content associated with a paragraph or character style. The flag can be one of the types defined in <code>kvtypes.h</code> . They are described in Flags for Defining Styles, on page 89 . The value associated with each flag is a hexadecimal number. You can set an option by either entering the converted decimal value, or by entering the flag's text (for example, <code>KVSTYLE_PRE</code>). The value of <code>Flags</code> in the template files is passed to this member of <code>KVStyle</code> .

Discussion

- This structure applies to word processing documents only.
- By default, HTML Export maps the heading style "Heading 1" to `<h1></h1>`, and so on, for heading levels 1 through 6. If you use style mappings, the default mapping is overridden. Therefore, you must supply markup for *all* heading levels.

- When the user-defined markup in `KVStyle` conflicts with other markup generated by HTML Export, the user-defined markup takes precedence.

KVSumInfoElemEx

This structure defines the individual metadata elements.

```
typedef struct tag_KVSumInfoElemEx
{
    int             isValid;
    KVSumInfoType  type;
    void           *data;
    char          *pcType;
}
KVSumInfoElemEx;
```

Member Descriptions

- `isValid` Specifies whether the data value is present in the document. The setting 1 specifies that the value is valid and exists.
- `type` The data type of the metadata element. The types are defined in the `KVSumInfoType` structure in `kvtypes.h`. See [KVSumInfoType, on page 271](#).
- `data` The content of the metadata field.
- If the `type` member is `KV_Int4` or `KV_Boo1`, this member contains the actual value. Otherwise, this member is a pointer to the actual value.
- `KV_DateTime` and `KV_IEEE8` point to an 8-byte value.
- `KV_String` and `KV_Unicode` point to the beginning of the string that contains the text.
- `pcType` A pointer to the name of the metadata field.

KVSummaryInfoEx

This structure provides a count of the number of metadata elements, and a pointer to the first element of the array of individual elements. The structure is initialized by calling the `fpGetSummaryInfo()` function. See [fpGetSummaryInfo\(\), on page 182](#).

```
typedef struct tag_KVSummaryInfoEx
{
    int             nElem;
    KVSumInfoElemEx *pElem;
```

```
}  
KVSummaryInfoEx;
```

Member Descriptions

nElem The number of metadata elements contained in the array. **nElem** can be zero. This indicates that the document did not contain metadata, such as an ASCII text document.

pElem Points to the first element of the array of document metadata elements defined by the **KVSumInfoElemEx** structure. See [KVSumInfoElemEx](#), on the previous page.

KVXConfigInfo

This structure defines an XML document type and the element extraction settings for that type. The settings can be applied based on the file format ID, or the file's root element. This structure is in `kvtypes.h` and is initialized by calling the `KVHTMLConfig()` function. See [Convert XML Files](#), on page 111 and [KVHTMLConfig\(\)](#), on page 190.

```
typedef struct TAG_KVXConfigInfo  
{  
    ENdocFmt    eKVFormat;  
    char*      pszRoot;  
    char*      pszInMeta;  
    char*      pszExMeta;  
    char*      pszInContent;  
    char*      pszExContent;  
    char*      pszInAttribute;  
}KVXConfigInfo;
```

Member Descriptions

eKVFormat The format ID as detected by the KeyView detection module. This determines the file type to which these extraction settings apply. The format ID is defined by the **ENdocFmt** enumerated type in `adinfo.h`. See [File Format Detection](#), on page 454 for more information on format ID values.

If you are adding configuration settings for a custom XML document type, this is not defined.

pszRoot The file's root element. When the format ID is not defined, the root element is used to determine the file type to which these settings apply.

To further qualify the element, specify its namespace. See [Specify an Element's Namespace and Attribute](#), on page 115.

pszInMeta	<p>The elements extracted from the file as metadata. All other elements are extracted as text. Multiple entries must be separated by commas.</p> <p>To further qualify the element, specify its namespace, its attributes, or both. See Specify an Element's Namespace and Attribute, on page 115.</p>
pszExMeta	<p>The child elements in the included metadata elements that are not extracted from the file as metadata. For example, the default extraction settings for the Visio XML format extract the DocumentProperties element as metadata. This element includes child elements such as Title, Subject, Author, Description, and so on. However, the child element PreviewPicture is defined in pszExMeta because it is binary data and should not be extracted.</p> <p>You cannot exclude any metadata elements from the output for StarOffice files. All metadata is extracted regardless of this setting.</p> <p>To further qualify the element, specify its namespace, its attributes, or both. See Specify an Element's Namespace and Attribute, on page 115.</p>
pszInContent	<p>The elements extracted from the file as content text. An asterisk (*) extracts all elements including child elements.</p> <p>To further qualify the element, specify its namespace, its attributes, or both. See Specify an Element's Namespace and Attribute, on page 115.</p>
pszExContent	<p>The child elements in the included content elements that are not extracted from the file as content text.</p> <p>To further qualify the element, specify its namespace, its attributes, or both. See Specify an Element's Namespace and Attribute, on page 115.</p>
pszInAttribute	<p>The attribute values extracted from the file. If attributes are not defined, attribute values are not extracted. The namespace (if used), element name, and attribute name must be defined in the following format:</p> <p><i>namespace:elementname@attributename</i></p> <p>For example:</p> <p>microfocus:division@name</p>

KVHTMLCallbacksEx

This structure provides all callbacks that can result from a call to `fpConvertStream()` or `KVHTMLConvertFile()`. See [fpConvertStream\(\), on page 171](#) and [KVHTMLConvertFile\(\), on page 198](#). Any and all of the function pointers can be NULL.

```
typedef BOOL (pascal *KVHTMLCB_CONTINUE)(
    void                *pcallingContext,
    int                 nPercentDone);
typedef BOOL (pascal *KVHTMLCB_GETANCHOREX)(
    void                *pCallingContext,
    KVHTMLAnchorTypeEx eAnchorTypeEx,
```

```
    char                *pszAnchor,
    int                 cbAnchorMax,
    BYTE               *pcHTML,
    UINT               cbHTML);
typedef BOOL (pascal *KVHTMLCB_GETAUXOUTPUTEX) (
    void                *pCallingContext,
    KVHTMLAnchorTypeEx eAnchorTypeEx,
    char                *pszAnchor,
    KVOutputStream      *pNewOutput);
typedef BOOL (pascal *KVHTMLCB_USERCBEX) (
    void                *pCallingContext,
    char                *psUserCBid,
    KVOutputStream      *pOutput,
    void                *pReserved);
typedef struct tag_KVHTMLCallbacksEx
{
    KVHTMLCB_CONTINUE      Continue;
    KVHTMLCB_GETANCHOREX  GetAnchor;
    KVHTMLCB_GETAUXOUTPUTEX GetAuxOutput;
    KVHTMLCB_USERCBEX     UserCB;
}
KVHTMLCallbacksEx;
```

Member Descriptions

- The members of this structure are pointers to the functions described in [HTML Export API Callback Functions, on page 209](#).
- If `GetAuxOutput()` is NULL, the `pszDefaultOutputDirectory` member of the instance of `KVHTMLOptionsEx` is used as the base storage location for auxiliary output files. If `pszDefaultOutputDirectory` is also NULL, auxiliary files are placed in the current working directory. See [KVHTMLOptionsEx, on page 237](#).

KVHTMLHeadingInfo

This structure defines how HTML Export creates heading information based on the source document's content and attributes. Source text is converted to a heading and included in the table of contents if

- it meets *all* the criteria defined by this structure, and
- the `headingCreateType` member of `KVHTMLTOCOptions` is set to allow automatic heading generation.

HTML Export evaluates the text against each member in the order in which the members appear below.

See [KVHTMLTOCOptions, on page 250](#) for more information on automatic generation of headings.

When you convert PDF files to HTML by using the default reader, `pdfsr`, the table of contents is generated from "bookmarks" within the PDF file. This structure is not used. The table of contents appear either at the beginning of the HTML file or in a separate frame.

```
typedef struct tag_KVHTMLHeadingInfo
{
    int        minParaLen;
    int        maxParaLen;
    int        fontSizeMin;
    int        fontSizeMax;
    BOOL       bMustBeBold;
    BOOL       bMustBeItalic;
    BOOL       bMustBeUnderlined;
    BOOL       bNonZeroIndent;
    BOOL       bNoTabs;
    BOOL       bNoMultiSpaces;
    int        mSpaceBefore;
    int        mSpaceAfter;
}
KVHTMLHeadingInfo;
```

Member Descriptions

<code>minParaLen</code>	<p>The minimum number of characters that text in the source document can contain for the text to meet the criteria for heading conversion.</p> <p>This option applies to word processing documents only.</p> <p>The default is 3 for heading levels 1 to 3.</p>
<code>maxParaLen</code>	<p>The maximum number of characters that text in the source document can contain for the text to meet the criteria for heading conversion.</p> <p>This option applies to word processing documents only.</p> <p>The default is 80 for heading levels 1 to 3.</p>
<code>fontSizeMin</code>	<p>The minimum font size of text in the source document for the text to meet the criteria for heading conversion.</p> <p>The default is 14 for heading level 1, and 12 for heading levels 2 and 3.</p>
<code>fontSizeMax</code>	<p>The maximum font size of text in the source document for the text to meet the criteria for heading conversion.</p> <p>The default is 20 for heading level 1, and 14 for heading levels 2 and 3.</p>
<code>bMustBeBold</code>	<p>If you set <code>bMustBeBold</code> to TRUE, the text in the source document must be bold to meet the criteria for heading conversion.</p> <p>The default is TRUE for heading levels 1 and 2, and FALSE for heading level 3.</p>
<code>bMustBeItalic</code>	<p>If you set <code>bMustBeItalic</code> to TRUE, the text in the source document must be</p>

	italic to meet the criteria for heading conversion. The default is FALSE.
<code>bMustBeUnderlined</code>	If you set <code>bMustBeUnderlined</code> to <code>TRUE</code> , the text in the source document must be underlined to meet the criteria for heading conversion. The default is FALSE.
<code>bNonZeroIndent</code>	If you set <code>bNonZeroIndent</code> to <code>TRUE</code> , the text in the source document must be indented to meet the criteria for heading conversion. If you set <code>bNonZeroIndent</code> to <code>FALSE</code> , the text must be aligned left. The default is FALSE.
<code>bNoTabs</code>	If you set <code>bNoTabs</code> to <code>TRUE</code> , the text in the source document must <i>not</i> contain tabs to meet the criteria for heading conversion. The default is FALSE.
<code>bNoMultiSpaces</code>	If you set <code>bNoMultiSpaces</code> to <code>TRUE</code> , the text in the source document must <i>not</i> contain two or more contiguous white spaces to meet the criteria for heading conversion. The default is FALSE.
<code>mSpaceBefore</code>	The amount of space in TWIPS (20th of a point) that must come before a paragraph in the source document for the text to meet the criteria for heading conversion. If <code>-1</code> is used, the amount of space before the paragraph is not considered in the heading generation. The default is <code>0</code> .
<code>mSpaceAfter</code>	The amount of space in TWIPS (20th of a point) that must follow a paragraph in the source document for the text to meet the criteria for heading conversion. If <code>-1</code> is used, the amount of space after the paragraph is not considered in the heading generation. The default is <code>0</code> .

KVHTMLHighlight

This structure defines the search terms that are found and highlighted in the HTML output. It is initialized by calling `KVHTMLSetHighlight()` and is defined in `kvtypes.h`. See [KVHTMLSetHighlight\(\), on page 202](#).

```
typedef struct tag_KVHTMLHighlight
{
    KVStructHeader;
    char          **pPHLTerms;
    int           nSize;
    KVCharset     eCharset;
    char          *pHLStart;
```

```
    char        *pHLEnd;  
    BOOL        bMatchCase;  
    int         nReserved;  
    void        *pReserved;  
}  
KVHTMLHighlight;
```

Member Descriptions

KVStructHeader	The KeyView version of the structure. See KVStructHead, on page 224 .
ppHLTerms	An array of terms to be found and highlighted in the HTML output.
nSize	The number of terms to be found and highlighted in the HTML output.
eCharset	The character set of the terms. The available character sets are enumerated in KVCharSet in kvcharset.h. See Convert Character Sets, on page 83 .
pHLStart	The start tag that specifies the text attributes used to highlight the text string.

NOTE: If you output images as SVG, KeyView uses this tag to highlight the terms found in images, so you must make sure that the tag works as expected. In particular, CSS that applies a style to a class does not affect a tag with that class that is inside an SVG.

For example:

```
<span style="color:#ff0000;background-color:#00FF00;">
```

pHLEnd	The end tag used to close the highlighting start tag. The end tag for the example above would be
bMatchCase	This Boolean applies only to searches on documents with a target character set of 1252. If this Boolean is set, the text search is case sensitive. By default, the text search is case insensitive.
nReserved	Reserved for future use.
pReserved	Reserved for future use.

KVHTMLInterfaceEx

NOTE: This structure has been superseded by [KVHTMLInterfaceEx2](#); KVHTMLInterfaceEx2 should be used instead of KVHTMLInterfaceEx.

The members of this structure are pointers to the API functions described in [HTML Export API Functions, on page 167](#).

```
typedef void* (pascal *KVHTML_INITEX) (  
    KVMemoryStream      *pMemAllocator,  
    char                 *pszKeyViewDir,  
    char                 *pszDataFile,  
    KVErrorCode          *pError,  
    DWORD                dWord);  
typedef void (pascal *KVHTML_SHUTDOWN)(void*);  
typedef BOOL (pascal *KVHTML_CONVERT_STREAMEX) (  
    void                 *pContext,  
    void                 *pCallingContext,  
    KVInputStream        *pInput,  
    KVOutputStream       *pOutput,  
    KVHTMLTemplateEx    *pTemplatesEx,  
    KVHTMLOptionsEx     *pOptionsEx,  
    KVHTMLTOCOOptions   *pTOCCreateOptions,  
    KVHTMLCallbacksEx   *pCallbacksEx,  
    BOOL                 bIndex,  
    KVErrorCode          *pError);  
typedef char** (pascal *KVHTML_GET_FILE_LIST)(  
    void                 *pContext,  
    int                  *pnSize );  
typedef BOOL (pascal *KVHTML_GET_STREAM_INFO)(  
    void                 *pContext,  
    KVInputStream        *pInput,  
    KVStreamInfo         *pStreamInfo );  
typedef BOOL (pascal *KVHTML_GET_ANCHOREX) (  
    void                 *pCallingContext,  
    KVHTMLAnchorTypeEx  eAnchorTypeEx,  
    char                 *pszAnchor,  
    int                  cbAnchorMax,  
    BYTE                 *pcHTML,  
    UINT                 cbHTML);  
typedef BOOL (pascal *KVHTML_INPUTSTREAM_CREATE) (  
    void                 *pContext,  
    char                 *pszFileName,  
    KVInputStream        *pInput);  
typedef BOOL (pascal *KVHTML_INPUTSTREAM_FREE) (  
    void                 *pContext,  
    KVInputStream        *pInput);  
typedef BOOL (pascal *KVHTML_OUTPUTSTREAM_CREATE) (  
    void                 *pContext,  
    char                 *pszFileName,  
    KVOutputStream       *pOutput );  
typedef BOOL (pascal *KVHTML_OUTPUTSTREAM_FREE)(  
    void                 *pContext,  
    KVOutputStream       *pOutput );  
typedef KVLanguageID (pascal *KVHTML_LANGUAGE_ID)(void *pContext);  
typedef BOOL (pascal *KVHTML_GET_SUMMARY_INFO)(  
    void                 *pContext,
```

```
    KVInputStream      *pInput,
    KVSummaryInfoEx   *pSummary,
    BOOL              bFree );
typedef BOOL (pascal *KVHTML_SET_STYLE_MAPPING) (
    void              *pContext,
    KVStyle           *pStyles,
    int               iStyles,
    BOOL              bCopy);
typedef BOOL (pascal *KVHTML_VALIDATE_TEMPLATE)(
    void              *pContext,
    KVOutputStream    *pOutput,
    KVHTMLTemplate    *pTemplate,
    KVHTMLOptions     *pOptions,
    KVHTMLTOCOptions *pTOCOptions,
    KVHTMLCallbacks   *pCallBalls,
    KVMemoryStream    *pMemStream)
typedef struct tag_KVHTMLInterfaceEx
{
    KVHTML_INITEX      fpInit;
    KVHTML_SHUTDOWN    fpShutDown;
    KVHTML_CONVERT_STREAMEX fpConvertStream;
    KVHTML_GET_FILE_LIST fpGetConvertFileList;
    KVHTML_GET_STREAM_INFO fpGetStreamInfo;
    KVHTML_GET_ANCHOREX fpGetAnchor;
    KVHTML_INPUTSTREAM_CREATE fpFileToInputStreamCreate;
    KVHTML_INPUTSTREAM_FREE fpFileToInputStreamFree;
    KVHTML_OUTPUTSTREAM_CREATE fpFileToOutputStreamCreate;
    KVHTML_OUTPUTSTREAM_FREE fpFileToOutputStreamFree;
    KVHTML_GET_SUMMARY_INFO fpGetSummaryInfo;
    KVHTML_SET_STYLE_MAPPING fpSetStyleMapping;
    KVHTML_VALIDATE_TEMPLATE fpValidateTemplate;
}
        KVHTMLInterfaceEx;
```

Member Descriptions

The members of this structure are function pointers to the functions described in [HTML Export API Functions, on page 167](#).

KVHTML_LANGUAGE_ID and KVHTML_VALIDATE_TEMPLATE are currently not implemented.

KVHTMLInterfaceEx2

The members of this structure are pointers to the API functions described in [HTML Export API Functions, on page 167](#).

This structure supersedes KVHTMLInterfaceEx. KVHTMLInterfaceEx2 should be used instead of KVHTMLInterfaceEx.

Compared to KVHTMLInterfaceEx, KVHTMLInterfaceEx2 adds two functions for checking error codes, and allows for binary compatible extensibility in future releases.

```
typedef void* (pascal *KVHTML_INITEX) (  
    KVMemoryStream *pMemAllocator,  
    char *pszKeyViewDir,  
    char *pszDataFile,  
    KVErrrorCode *pError,  
    DWORD dWord);  
typedef void (pascal *KVHTML_SHUTDOWN)(void*);  
typedef BOOL (pascal *KVHTML_CONVERT_STREAMEX) (  
    void *pContext,  
    void *pCallingContext,  
    KVInputStream *pInput,  
    KVOutputStream *pOutput,  
    KVHTMLTemplateEx *pTemplatesEx,  
    KVHTMLOptionsEx *pOptionsEx,  
    KVHTMLTOCOptions *pTOCCreateOptions,  
    KVHTMLCallbacksEx *pCallbacksEx,  
    BOOL bIndex,  
    KVErrrorCode *pError);  
typedef char** (pascal *KVHTML_GET_FILE_LIST)(  
    void *pContext,  
    int *pnSize );  
typedef BOOL (pascal *KVHTML_GET_STREAM_INFO)(  
    void *pContext,  
    KVInputStream *pInput,  
    KVStreamInfo *pStreamInfo );  
typedef BOOL (pascal *KVHTML_GET_ANCHOREX) (  
    void *pCallingContext,  
    KVHTMLAnchorTypeEx eAnchorTypeEx,  
    char *pszAnchor,  
    int cbAnchorMax,  
    BYTE *pcHTML,  
    UINT cbHTML);  
typedef BOOL (pascal *KVHTML_INPUTSTREAM_CREATE) (  
    void *pContext,  
    char *pszFileName,  
    KVInputStream *pInput);  
typedef BOOL (pascal *KVHTML_INPUTSTREAM_FREE) (  
    void *pContext,  
    KVInputStream *pInput);  
typedef BOOL (pascal *KVHTML_OUTPUTSTREAM_CREATE) (  
    void *pContext,  
    char *pszFileName,  
    KVOutputStream *pOutput );  
typedef BOOL (pascal *KVHTML_OUTPUTSTREAM_FREE)(  
    void *pContext,
```

```
        KVOutputStream *pOutput );
typedef KVLanguageID (pascal *KVHTML_LANGUAGE_ID)(void *pContext);
typedef BOOL (pascal *KVHTML_GET_SUMMARY_INFO)(
    void *pContext,
    KVInputStream *pInput,
    KVSummaryInfoEx *pSummary,
    BOOL bFree );
typedef BOOL (pascal *KVHTML_SET_STYLE_MAPPING) (
    void *pContext,
    KVStyle *pStyles,
    int iStyles,
    BOOL bCopy);
typedef BOOL (pascal *KVHTML_VALIDATE_TEMPLATE)(
    void *pContext,
    KVOutputStream *pOutput,
    KVHTMLTemplate *pTemplate,
    KVHTMLOptions *pOptions,
    KVHTMLTOCOOptions *pTOCOOptions,
    KVHTMLCallbacks *pCallBalls,
    KVMemoryStream *pMemStream);
typedef KVErrCode (pascal *KVHTML_GET_KV_ERROR_CODE)(void *);
typedef KVErrCodeEx (pascal *KVHTML_GET_KV_ERROR_CODE_EX)(void *);

typedef struct tag_KVHTMLInterfaceEx2
{
    KVStructHeader;
    KVHTML_INITEX fpInit;
    KVHTML_SHUTDOWN fpShutDown;
    KVHTML_CONVERT_STREAMEX fpConvertStream;
    KVHTML_GET_FILE_LIST fpGetConvertFileList;
    KVHTML_GET_STREAM_INFO fpGetStreamInfo;
    KVHTML_GET_ANCHOREX fpGetAnchor;
    KVHTML_INPUTSTREAM_CREATE fpFileToInputStreamCreate;
    KVHTML_INPUTSTREAM_FREE fpFileToInputStreamFree;
    KVHTML_OUTPUTSTREAM_CREATE fpFileToOutputStreamCreate;
    KVHTML_OUTPUTSTREAM_FREE fpFileToOutputStreamFree;
    KVHTML_GET_SUMMARY_INFO fpGetSummaryInfo;
    KVHTML_SET_STYLE_MAPPING fpSetStyleMapping;
    KVHTML_VALIDATE_TEMPLATE fpValidateTemplate;
    KVHTML_GET_KV_ERROR_CODE fpGetKvErrorCode;
    KVHTML_GET_KV_ERROR_CODE_EX fpGetKvErrorCodeEx;
}
KVHTMLInterfaceEx2;
```

KVHTMLOptionsEx

This structure defines the options that control the HTML markup written in response to the general style and attributes (font, color, and so on) of the document. A pointer to this structure is passed as an argument to the function `fpConvertStream()` or `KVHTMLConvertFile()`.

```
typedef struct tag_KVHTMLOptionsEx
{
    KVCharSet                OutputCharSet;
    BOOL                    bUseDocumentColors;
    BOOL                    bUseDocumentFontInfo;
    BOOL                    bSupportFontFace;
    BOOL                    bSupportUserFontSizeMapping;
    KVFontSizeMap           FontSizeMap;
    BOOL                    bDisplayRelativeFontSize;
    BOOL                    bSupportRFC1942_cols;
    BOOL                    bNbspEmptyCells;
    ENSATableBorder         STableBorder;
    int                     nTableBorderWidth;
    char                    *pszBaseURL;
    char                    *pszMainURL;
    char                    *pszDefaultOutputDirectory;
    char                    *pszPicPath;
    char                    *pszPicURL;
    char                    *pszJavaURL;
    char                    *pszJavaArchive;
    BOOL                    bRemoveFileNameSpaces;
    BOOL                    bRasterizeFiles
    KVHTMLGraphicType       OutputRasterGraphicType;
    KVHTMLGraphicType       OutputVectorGraphicType;
    int                     cxVectorToRasterXRes;
    int                     cyVectorToRasterYRes;
    BOOL                    bGenerateURLs;
    long                    lcbMaxMemUsage;
    BOOL                    bSupportColumnHeadings;
    BOOL                    bSupportRowHeadings;
    BOOL                    bSupportCellSpan;
    BOOL                    bSupportRowSpan;
    BOOL                    bSupportColumnWidth;
    BOOL                    bRemoveEmptyColumns;
    BOOL                    bRemoveEmptyRows;
    int                     nRowsBeforeSplit;
    KVLanguageID            OutputLanguageID;
    KVHTMLStyleSheetType    eStyleSheetType
    BOOL                    bTabsToTables;
    BOOL                    bForceOutputCharSet;
    BOOL                    bEnableEmptyRows;
}
```

```
        BYTE                cReplaceChar;  
        BYTE                cRedact;  
        KVCharSet          eSrcCharSet;  
        BOOL               bForceSrcCharSet;  
        int                 nCompressionQuality;  
    }  
KVHTMLOptionsEx;
```

Member Descriptions

OutputCharSet	<p>The character set to use for textual output. The available character sets are enumerated in KVCharSet in kvcharset.h. See Convert Character Sets, on page 83</p> <p>To make sure that the character set defined here is used, you must set bForceOutputCharSet to TRUE.</p> <p>The default is KVCS_UNKNOWN.</p>
bUseDocumentColors	<p>Set bUseDocumentColors to TRUE to retain the color attributes information contained in the source document. If you set bUseDocumentColors to FALSE, no color attributes appear in the tags of the output.</p> <p>The default is FALSE.</p>
bUseDocumentFontInfo	<p>Set bUseDocumentFontInfo to TRUE to retain the font information contained in the source document. If you set bUseDocumentFontInfo to FALSE, no font information appears in the tags in the output.</p> <p>The default is FALSE.</p>
bSupportFontFace	<p>Set bSupportFontFace to TRUE to retain the font face information contained in the source document. If you set bSupportFontFace to FALSE, no FACE attributes appear in the tags of the HTML output.</p> <p>This applies only when you set eStyleSheetType to STYLESHEET_DISABLED. The default is TRUE.</p>
bSupportUserFontSizeMapping	<p>Set bSupportUserFontSizeMapping to TRUE to use the font sizes specified in the FontSizeMap. If you set bSupportUserFontSizeMapping to FALSE, HTML Export uses default size attributes.</p> <p>This applies only when you set eStyleSheetType to STYLESHEET_DISABLED. The default is FALSE.</p>
FontSizeMap	<p>The font sizes to which the HTML tags through correspond. If bSupportUserFontSizeMapping is FALSE, this member can be left blank.</p>

	See the Discussion section for more information.
<code>bDisplayRelativeFontSize</code>	<p>Set <code>bDisplayRelativeFontSize</code> to TRUE to use relative font size tags in the HTML output. For example, the tag <code></code> adds one to the base font size, which is normally three.</p> <p>The default is FALSE.</p>
<code>bSupportRFC1942_cols</code>	<p>Set <code>bSupportRFC1942_cols</code> to TRUE to include <code>cols=integer</code> specifications in the <code><table></code> tags of the HTML output.</p> <p>The default is TRUE.</p>
<code>bNbspEmptyCells</code>	<p>Set <code>bNbspEmptyCells</code> to TRUE to include a non-breaking space (<code><td>&nbsp;</td></code>) in the markup for empty table cells in the source document. If you set <code>bNbspEmptyCells</code> to FALSE, <code><td></td></code> is generated for empty table cells.</p> <p>This option applies to word processing documents and spreadsheets only.</p> <p>The default is TRUE.</p>
<code>SATableBorder</code>	<p>Specifies whether table borders are based on the setting in the source document, are always on, or are always off. The options are enumerated in <code>ENSATableBorder</code> in <code>kvtypes.h</code>. See ENSATableBorder, on page 257.</p> <p>This option applies to word processing documents only.</p> <p>The default is <code>SA_BaseOnDocument</code>.</p>
<code>nTableBorderWidth</code>	<p>Sets the width of the table border in pixels.</p> <p>This option applies to word processing documents only.</p> <p>The default is 1.</p>
<code>pszBaseURL</code>	<p>The base URL that replaces the <code>\$BASE</code> token in the HTML output. See \$BASE, on page 451.</p> <p>The default is <code>NULL</code>.</p>
<code>pszMainURL</code>	<p>The URL that replaces the <code>\$MAINURL</code> token in the HTML output. See \$MAINURL, on page 452.</p> <p>The default is <code>NULL</code>.</p>
<code>pszDefaultOutputDirectory</code>	<p>The default output directory for auxiliary files created during the conversion.</p> <p>The default is <code>NULL</code>, and the files are placed in the directory in which your application is running.</p>
<code>pszPicPath</code>	<p>The output directory for graphics created during the conversion. If specified, this member can also be used by the callback functions <code>KVHTMLGetAnchorEx</code> and <code>KVHTMLGetAuxOutputEx</code>.</p>

	<p>This option applies to word processing documents only.</p> <p>The default is NULL, and the files are placed in the directory in which your application is running.</p>
pszPicURL	<p>The URL of the picture files created from embedded graphics in the source document. To specify a complete image source, this element must be combined with pszAnchor of the GetAnchor() callback function. See GetAnchor(), on page 210.</p> <p>For example, setting pszPicURL to <code>../cgi-bin/</code> and setting pszAnchor to <code>pic.jpg</code> results in the following markup:</p> <pre></pre> <p>This element applies to word processing documents only. The default is NULL.</p>
bRemoveFileNameSpaces	<p>Set bRemoveFileNameSpaces to TRUE to remove spaces from generated output file names.</p> <p>The default is FALSE.</p>
bRasterizeFiles	<p>Set bRasterizeFiles to TRUE to rasterize slides from presentations into single images. For this setting to take effect, you must set the bNoPictures, on page 244 member to FALSE. The format the images are converted to is determined by the OutputRasterGraphicType, below member.</p> <p>Set bRasterizeFiles to FALSE to convert the text in slides to HTML. When you set this member to FALSE, images do not appear in the HTML output.</p> <p>The default is FALSE.</p> <div style="border: 1px solid #0070C0; padding: 5px;"><p>NOTE: When bRasterizeFiles is FALSE, the export process uses the ordering in the file to produce the output, which does not necessarily match the logical reading order for the presentation. To use a logical reading order instead, you can set the LogicalOrder parameter in the [Options] section of formats_e.ini. See Convert Presentation Files, on page 110.</p></div>
OutputRasterGraphicType	<p>The output format of rasterized embedded graphics. There are six options enumerated in KVHTMLGraphicType in kvhtml.h. See KVHTMLGraphicType, on page 266.</p>
OutputVectorGraphicType	<p>The output format of vector graphics. The options are enumerated in KVHTMLGraphicType in kvhtml.h. See KVHTMLGraphicType, on page 266. For more information on displaying vector graphics on UNIX or Linux, see Display Vector Graphics on UNIX and Linux, on page 91.</p> <p>If you turn on highlighting by using KVHTMLSetHighlight(), KeyView highlights matching terms that occur in vector graphics.</p>

When you output to SVG, it highlights the terms by using the HTML you specify in `KVHTMLHighlight`. When you output to any other format, KeyView highlights the terms by changing the text color.

<code>cxVectorToRasterXRes</code>	<p>Specifies the horizontal resolution when converting presentation files and vector graphics. This is set in conjunction with <code>cyVectorToRasterYRes</code>. For more information, see Set the Resolution of Presentations and Vector Graphics, on page 245.</p> <p>The default value is 0, which means the original resolution is retained.</p>
<code>cyVectorToRasterYRes</code>	<p>Specifies the vertical resolution when converting presentation files and vector graphics. This is set in conjunction with <code>cxVectorToRasterXRes</code>. For more information, see Set the Resolution of Presentations and Vector Graphics, on page 245.</p> <p>The default value is 0, which means the original resolution is retained.</p>
<code>bGenerateURLs</code>	<p>Set <code>bGenerateURLs</code> to TRUE to add anchor tags (<code><a . . .></code>) to text starting with "www", "http:" or "file:".</p> <p>This option applies to word processing documents only. The default is FALSE.</p>
<code>lcbMaxMemUsage</code>	<p>The maximum memory allocated dynamically for token buffers during file processing. If this maximum is reached, Export performs a swap-to-disk operation internally, and then reuses the memory blocks. Export maintains an internal minimum memory size.</p> <p>This option applies to word processing or text documents only. The default is <code>LONG_MAX</code>. The unit is in bytes.</p>
<code>bSupportColumnHeadings</code>	<p>Set <code>bSupportColumnHeadings</code> to TRUE to include column headings from the source spreadsheet in the output.</p> <p>This option applies to spreadsheets only. The default is FALSE.</p>
<code>bSupportRowHeadings</code>	<p>Set <code>bSupportRowHeadings</code> to TRUE to include row headings from the source spreadsheet in the output.</p> <p>This option applies to spreadsheets only. The default is FALSE.</p>
<code>bSupportCellSpan</code>	<p>Set <code>bSupportCellSpan</code> to TRUE to include <code>colspan="n"</code> markup in the output. If text in the source document spans across empty columns, and <code>bSupportCellSpan</code> is enabled, the text is output across columns in the HTML. If this option is disabled, text that spans across columns is output in a single cell.</p> <p>This option applies to spreadsheets only. The default value is FALSE.</p>

<code>bSupportRowSpan</code>	<p>Set <code>bSupportRowSpan</code> to TRUE to include row span data from the source spreadsheet in the output.</p> <p>This option applies to spreadsheets only. The default value is FALSE. Currently not supported.</p>
<code>bSupportColumnWidth</code>	<p>Set <code>bSupportColumnWidth</code> to TRUE to include column width data from the source document in the output.</p> <p>This option applies to spreadsheets only. The default value is FALSE.</p>
<code>bRemoveEmptyColumns</code>	<p>Set <code>bRemoveEmptyColumns</code> to TRUE to remove columns that do not contain text or color. To remove empty columns, you must set <code>bSupportCellSpan</code> to FALSE.</p> <p>This option applies to spreadsheets only. The default is FALSE.</p>
<code>bRemoveEmptyRows</code>	<p>Set <code>bRemoveEmptyRows</code> to TRUE to remove empty rows that do not contain text or color. This option applies to spreadsheets only.</p> <p>The default is FALSE.</p>
<code>nRowsBeforeSplit</code>	<p>The approximate number of spreadsheet rows to be processed before splitting a table. This helps to prevent large spreadsheet tables from occurring in a single document, which can cause speed and processing problems for the browser.</p> <p>This option applies to spreadsheets only. The default is 0.</p>
<code>OutputLanguageID</code>	<p>The language for the textual output of language-specific data such as time and date. <code>OutputLanguageID</code> must be in the system locale. If <code>OutputLanguageID</code> is invalid or not supplied, the system default is used. Language IDs are defined in <code>KVLanguageID</code> in <code>kvtypes.h</code>.</p> <p>The default is <code>Language_UNKNOWN</code>.</p>
<code>eStyleSheetType</code>	<p>One of the enumerated options for processing style sheet information. The options are defined in <code>KVHTMLStyleSheetType</code> in <code>kvhtml.h</code>. See KVHTMLStyleSheetType, on page 264.</p> <p>STYLESHEET_DISABLED—Disables Cascading Style Sheet (CSS) formatting.</p> <p>CSS_INLINE—Enables CSS formatting, and adds style sheet information inline to the HTML output file.</p> <p>CSS_TOFILE—Enables CSS formatting, and generates an external file or uses an existing external file, which is referenced in a <code><link...></code> element.</p> <p>The default is <code>STYLESHEET_DISABLED</code>.</p>
<code>bTabsToTables</code>	<p>Set <code>bTabsToTables</code> to TRUE to convert tabbed columns to tables. This option applies to word processing documents only.</p>

When you use `bTabsToTables`, the original font in the cells is not maintained. The `bTabsToTables` option is intended for use on plain text files. Its purpose is to make the text more readable when viewed in a browser. Font information is not written into the table cells that are generated. Instead, the default font of the browser is used.

The default is `FALSE`.

`bForceOutputCharSet` Set `bForceOutputCharSet` to `TRUE` to use the output character set specified in `OutputCharSet`. Forcing a character set to `KVCS_UNKNOWN` is always ignored. See [Convert Character Sets, on page 83](#).

The default is `FALSE`.

`bEnableEmptyRows` Set `bEnableEmptyRows` to `TRUE` to display empty rows in spreadsheets. If you set `bEnableEmptyRows` to `FALSE`, empty rows are not displayed. This option applies only to 20 or more consecutive empty rows.

This option applies to spreadsheets only. The default is `FALSE`.

`cReplaceChar` The character used when a character in the source document's character set cannot be mapped to the output character set.

The default replacement character is a question mark (?).

`cRedact` The character used to replace text that is designated through style mapping to be omitted from the output. This functionality is useful when you need to hide confidential or sensitive information.

The specified character is used for all text that is mapped to a style processed with the `KVSTYLE_REDACT` flag (defined in `kvtypes.h`). See [Map Styles, on page 87](#).

This option applies to word processing documents only. The default replacement character is "X".

`eSrcCharSet` Specifies the source character set of the document. The available character sets are enumerated in `KVCharSet` in `kvcharset.h`. See [Convert Character Sets, on page 83](#).

To make sure that the character set defined here is used, you must set `bForceSrcCharSet` to `TRUE`.

The default is `KVCS_UNKNOWN`.

`bForceSrcCharSet` Set `bForceSrcCharSet` to `TRUE` to use the source character set specified in `eSrcCharSet`, regardless of the internal document information. See [Convert Character Sets, on page 83](#).

Forcing a character set to `KVCS_UNKNOWN` is always ignored.

The default is `FALSE`.

<code>nCompressionQuality</code>	<p>Controls the output quality of graphics that support compression quality (for example, JPEG). A value of 0 means default quality (85 compression); 1 is the lowest quality (highest compression and therefore the smallest file size); 100 is the highest quality (no compression and therefore the largest file size).</p> <p>This option applies to word processing documents only. The default is 0.</p>
<code>bNoPictures</code>	<p>This member is only available in the structure in the template files. It is not part of the structure in the API.</p> <p>If you set <code>bNoPictures</code> to TRUE, embedded graphics in a document are not generated as separate files, image tags are not included in the output, CSS files do not work, and verbose markup is generated. Because graphics are not generated, the conversion is faster.</p> <div style="border: 1px solid #0070C0; padding: 5px;"><p>NOTE: If you want to use CSS files, you must set <code>bNoPictures</code> to FALSE and use the <code>KVHTMLSetStyleSheet()</code> function to request the CSS file (see Use Style Sheets, on page 90).</p></div> <p>If you set <code>bNoPictures</code> to FALSE, embedded graphics in a document are regenerated as separate files, stored in the output directory, and image tags are included in the output.</p> <p>This member is passed to the <code>bIndex</code> argument of the <code>fpConvertStream()</code> or <code>KVHTMLConvertFile()</code> functions.</p> <p>The default is FALSE.</p>

Discussion

- A pointer to this structure is passed as an argument to `fpConvertStream()` or `KVHTMLConvertFile()`. If the pointer to the structure is not `NULL`, the values of the members specified in the structure are used. If the pointer to the structure is `NULL`, the default values are used.
- `bNoPictures` is similar to the `KVCFG_BLANKPICTURE` flag in the call to `KVHTMLConfig()`. Unlike `bNoPictures`, the `KVCFG_BLANKPICTURE` flag generates image tags with an empty `src` attribute. [KVHTMLConfig\(\), on page 190](#).
- To output graphics for presentations, you must set `bNoPictures` to **FALSE**, and set `bRasterizeFiles` to **TRUE**.
- The values in [FontSizeMap, on page 238](#) indicate the range for the HTML tag ``. For example, if you specify 8, 10, 12, 14, 18, and 24:
 - font size `<= 8` in the source document is mapped to `` in the output HTML
 - else, font size `<=10` in the source document is mapped to `` in the output HTML
 - else, font size `<=12` in the source document is mapped to `` in the output HTML

- else, font size ≤ 14 in the source document is mapped to `` in the output HTML
- else, font size ≤ 18 in the source document is mapped to `` in the output HTML
- else, font size ≤ 24 in the source document is mapped to `` in the output HTML
- font size > 24 in source the document is mapped to `` in the output HTML

When the HTML output is viewed, the browser maps `` to a specific font size.

Set the Resolution of Presentations and Vector Graphics

The `cxVectorToRasterXRes` and `cyVectorToRasterYRes` members are set in conjunction to specify the resolution (width and height) at which presentation files and vector graphics are converted.

You can specify the resolution as an absolute size in pixels, or as a proportion of the original size.

KeyView always maintains the aspect ratio of the original graphic and does not increase the resolution. If you set values that would enlarge a graphic, KeyView only changes the size of the HTML element.

To set the resolution in pixels

To specify the resolution in pixels, specify the width (`cxVectorToRasterXRes`) and/or height (`cyVectorToRasterYRes`).

To export the largest image that fits within a bounding box, without changing the original aspect ratio, set both the width and height. For example, to export the largest image that fits in an 800x500 bounding box:

```
cxVectorToRasterXRes=800  
cyVextorToRasterYRes=500
```

Alternatively you can fix one of the dimensions. Set one value and set the other to zero. For example, to export images with a height of 1500 pixels and whatever width is necessary to maintain the original aspect ratio:

```
cxVectorToRasterXRes=0  
cyVextorToRasterYRes=1500
```

The maximum size permitted for either dimension is 4000 pixels.

To set the resolution proportionally

To set the resolution proportionally, set `cxVectorToRasterXRes` to a negative value. A negative value represents a percentage of the original resolution. Set `cyVectorToRasterYRes` to 0 (zero). Negative (percentage) values for `cyVectorToRasterYRes` are ignored.

The following example exports a graphic at 50 percent of its original resolution:

```
cxVectorToRasterXRes=-50  
cyVectorToRasterYRes=0
```

KVHTMLTemplateEx

This structure defines the overall framework of the HTML output. Members in this structure define the HTML markup written at specific points in the output stream. The pointers contain HTML markup that might include embedded KeyView tokens. See [Export Tokens, on page 451](#) for more information on tokens. The structure is initialized by calling the `fpConvertStream()` or `KVHTMLConvertFile()` function. See [fpConvertStream\(\), on page 171](#) or [KVHTMLConvertFile\(\), on page 198](#).

```
typedef struct tag_KVHTMLTemplateEx
{
    char        *pszMainTop;
    char        *pszMainBottom;
    char        *pszFirstH1Start;
    char        *pszFirstH1End;
    char        *pszMiddleH1Start;
    char        *pszMiddleH1End;
    char        *pszLastH1Start;
    char        *pszLastH1End;
    char        *pszH[2..6]HTML;
    char        *pszTOCH[1..6]Start;
    char        *pszTOC_H[1..6];
    char        *pszTOCH[1..6]End;
    char        *pszXFile;
    char        *pszStartBlock;
    char        *pszEndBlock;
    BOOL        bPutBlocksInSeparateFiles;
    BOOL        bHardPageMakesNewBlock
    long        lcbBlockSize;
    char        *pszChunkTemplate;
    char        *pszTableHTML;
    BOOL        bTableHTMLForSpreadsheetOnly;
    char        *pszUserSummary;
    char        *pszXStartBlock;
    char        *pszXEndBlock;
    char        *pszTOCH[1..6]LeafNode;
}
KVHTMLTemplateEx;
```

Member Descriptions

<code>pszMainTop</code>	The markup and tokens inserted at the beginning of the main HTML file. Most of the template files feature <code><meta></code> tags with tokens that store the input document's metadata. This member should at least contain the <code><html></code> and <code><body></code> tags. For frame-
-------------------------	---

style output, this member must include the <frame> tag.

The default is NULL.

pszMainBottom The markup and tokens inserted at the end of the main HTML file. This member should at least contain the </html> and </body> tags, and should close the elements that are opened by pszMainTop.

The default is NULL.

pszFirstH1Start The markup and tokens inserted at the beginning of the first created H1 HTML block (that is, the block associated with the first H1 table of contents entry).

The default is NULL.

pszFirstH1End The markup and tokens inserted at the end of the first created H1 HTML block (that is, the block associated with the first H1 table of contents entry).

The default is NULL.

pszMiddleH1Start The markup and tokens inserted at the beginning of those H1 HTML blocks that are neither the first nor the last H1 blocks created (that is, blocks associated with all but the first and last H1 table of contents entries).

The default is NULL.

pszMiddleH1End The markup and tokens inserted at the end of those H1 HTML blocks that are neither the first nor the last H1 blocks created (that is, blocks associated with all but the first and last H1 table of contents entries).

The default is NULL.

pszLastH1Start The markup and tokens inserted at the beginning of the last created H1 HTML block (that is, the block associated with the last H1 table of contents entry).

The default is NULL.

pszLastH1End The markup and tokens inserted at the end of the last created H1 HTML block (that is, the block associated with the last H1 table of contents entry).

The default is NULL.

pszH[2..6]HTML The markup and tokens inserted in an HTML block for heading levels 2 through 6.

The default is NULL.

pszTOCH[1..6]Start The markup and tokens inserted at the beginning of a table of contents block for heading levels 1 through 6 entries. For example:

	<pre><ol type="I"> <ol type="1"> <ol type="i"></pre>
	<p>The default is NULL.</p>
<code>pszTOC_H[1..6]</code>	<p>The markup and tokens required to process the table of contents entries for heading levels 1 through 6. For example:</p> <pre>\$TOCTE</pre>
	<p>The default is NULL.</p>
<code>pszTOCH[1..6]End</code>	<p>The markup and tokens inserted at the end of a table of contents block for heading levels 1 through 6 entries. For example:</p> <pre></pre>
	<p>The default is NULL.</p>
<code>pszXFile</code>	<p>The markup and tokens generated and placed in an extra HTML file. This file holds content from the source document. For example, it could contain the table of contents (using the \$TOC token), which could then be displayed in an HTML frame. To process this file, you would use the \$XANCHOR token.</p> <p>For example, if the extra file contains the table of contents in frame-based HTML, set <code>pszXFile=\$TOC</code> and place the following HTML markup in the <code>pszMainTop</code> element:</p> <pre><frame src="\$XANCHOR" name="left" scrolling="auto" target="right"></pre>
	<p>See Export Tokens, on page 451 for more information on Export tokens.</p>
	<p>The default is NULL.</p>
<code>pszStartBlock</code>	<p>The markup and tokens inserted at the beginning of each block created as a result of <code>lcbBlockSize</code> or <code>bHardPageMakesNewBlock</code>.</p>
	<p>The default is NULL.</p>
<code>pszEndBlock</code>	<p>The markup and tokens inserted at the end of each block created as a result of the of <code>lcbBlockSize</code> or <code>bHardPageMakesNewBlock</code>.</p>
	<p>The default is NULL.</p>
<code>bPutBlocksInSeparateFiles</code>	<p>Set <code>bPutBlocksInSeparateFiles</code> to TRUE to create a separate HTML file for each heading level 1 block. Each new block uses the markup defined in <code>pszStartBlock</code> and <code>pszEndBlock</code>. If you set <code>bPutBlocksInSeparateFiles</code> to FALSE, each heading level 1 block is placed sequentially in the same file after the initial markup is written.</p>

	<p>The default is FALSE.</p>
bHardPageMakesNewBlock	<p>Set bHardPageMakesNewBlock to TRUE to have hard page breaks in the source document generate new HTML files during the conversion process. The bPutBlocksInSeparateFiles, on the previous page member must also be set to TRUE, and the pszChunkTemplate, below member must specify a table of contents entry for the new file.</p> <p>This option applies to word processing documents and spreadsheets only. Page boundaries in PDF documents are considered page breaks.</p> <p>The default is FALSE.</p>
lcbBlockSize	<p>The maximum size (in bytes) of heading level 1 HTML output files. This number is used as a guideline and can be exceeded to break content at a logical location. This setting is not used when exporting spreadsheets. To use lcbBlockSize, it must be set to a non-zero number, the bPutBlocksInSeparateFiles, on the previous page member must be set to TRUE, and the pszChunkTemplate, below member must specify a table of contents entry for new files created when the maximum size is reached.</p> <p>The default is 0. This means that the size is undefined and unlimited.</p>
pszChunkTemplate	<p>If a heading level 1 HTML block is subdivided into separate files because the block exceeds the size limitations specified in lcbBlockSize, or bHardPageMakesNewBlock is set, or partitioning on hard breaks or page size changes is turned on by using fpSetPartitionOn, this member defines the table of contents entry for the new file.</p> <p>The page number can be included in the table of contents entry by inserting the \$SPLITBLOCKNUMBER token. For example:</p> <p>Page \$SPLITBLOCKNUMBER</p> <p>The default is NULL.</p>
pszTableHTML	<p>Specifies the markup (no tokens) inserted at the beginning of each table created during the conversion process. If you set pszTableHTML, table cell color and border information from the document is ignored. This is used in conjunction with bTableHTMLForSpreadsheetOnly to control the look of generated spreadsheets.</p> <p>For example, to center the table, set the background color to teal, and set the border width to 13, use:</p> <pre>pszTableHTML=<table bgcolor="teal" border="13" align="center"></pre>

	The default is NULL.
bTableHTMLForSpreadsheetOnly	If set to TRUE, bTableHTMLForSpreadsheetOnly controls how spreadsheets are displayed in the output. If set to FALSE, cell color and border information from the source document is used. Use this member in conjunction with pszTableHTML. The default is FALSE.
pszUserSummary	The markup and tokens generated when the tokens \$USERSUMMARY or \$SUMMARY are used. For example: <code><meta name="\$NAME" content="\$CONTENT" /></code> The default is NULL.
pszXStartBlock	The markup and tokens inserted at the beginning of each HTML block generated by the \$XANCHOR token. If either this member or pszXEndBlock is defined, both pszStartBlock and pszEndBlock are ignored. See Export Tokens, on page 451 for more information on \$XANCHOR. The default is NULL.
pszXEndBlock	The markup and tokens inserted at the end of each HTML block generated by the \$XANCHOR token. If either this member or pszXStartBlock is defined, both pszStartBlock and pszEndBlock are ignored. See Export Tokens, on page 451 for more information on \$XANCHOR. The default is NULL.
pszTOCH[1..6]LeafNode	The markup that replaces pszTOC_H[1..6] entries for leaf nodes in the table of contents. A leaf node is a node that has no children. The default is NULL.

Discussion

A pointer to this structure is passed as an argument to `fpConvertStream()` and `KVHTMLConvertFile()`. If the pointer to the structure is not NULL, the values of the members specified in the structure are used. If the pointer to the structure is NULL, the default values are used.

KVHTMLTOCOptions

This structure defines whether a heading is included in the table of contents. Source text is converted to a heading in the HTML output if

- it meets *all* the criteria defined by the members of KVHTMLHeadingInfo (see [KVHTMLHeadingInfo](#), on page 229), and
- the headingCreateType member of KVHTMLTOCOptions is set to allow automatic heading generation.

The structure is initialized by calling the fpConvertStream() or KVHTMLConvertFile() function. See [fpConvertStream\(\)](#), on page 171 or [KVHTMLConvertFile\(\)](#), on page 198.

When PDF files are converted to HTML by using the default reader, pdfsr, the table of contents is generated from "bookmarks" within the PDF file. This structure is not used.

```
Typedef struct tag_KVHTMLTOCOptions
{
    BOOL                bAllowHeadingsInTables;
    KVHeadingCreateOptions headingCreateType;
    KVHTMLHeadingInfo  *pH1;
    KVHTMLHeadingInfo  *pH2;
    KVHTMLHeadingInfo  *pH3;
    KVHTMLHeadingInfo  *pH4;
    KVHTMLHeadingInfo  *pH5;
    KVHTMLHeadingInfo  *pH6;
}
KVHTMLTOCOptions;
```

Member Descriptions

bAllowHeadingsInTables This option determines if the text in tables is considered for automatic heading generation. If you set bAllowHeadingsInTables to **TRUE**, the text in tables is included in the determination of headings and table of contents entries.

This option applies to word processing documents and spreadsheets only.

The default is **FALSE**.

headingCreateType This option determines how HTML Export subdivides the source document into table of contents entries. This should be set to one of the two options that are enumerated in KVHeadingCreateOptions in kvhtml.h. See [KVHeadingCreateOptions](#), on page 267.

The determination of table of contents entries is based on whether the source document contains *heading styles* or whether *text attributes* conform to the criteria defined in the KVHTMLHeadingInfo structure. See [KVHTMLHeadingInfo](#), on page 229.

Heading styles are predefined style tags, such as "Heading 1" and "Heading 2" tags in a Microsoft Word document. Text attributes are bold, underlined, italic, and so on.

This option applies to word processing documents only.

	The default is <code>KVCS_DocHeadingsOnly</code> .
<code>KVHTMLHeadingInfo</code>	A pointer to the <code>KVHTMLHeadingInfo</code> structure. See KVHTMLHeadingInfo , on page 229. When the table of contents entries are not based on the source documents heading styles, the table of contents entries are determined by whether text attributes (such as bold, underlined, and italic text) in the source document meet all the criteria defined in <code>KVHTMLHeadingInfo</code> .

Discussion

A pointer to this structure is passed as an argument to `fpConvertStream()` and `KVHTMLConvertFile()`. If the pointer to the structure is not `NULL`, the values of the members specified in the structure are used. If the pointer to the structure is `NULL`, the default values are used.

KVRevisionMark

This structure defines the information generated when the revision feature is enabled and how the information is displayed. (see [Include Revision Information](#), on page 92). It defines the following:

- the contents of the `title` attribute for an `<ins>` or `` tag. See [Configure the Revision Title](#), on page 93.
- the style used to display revised text by different reviewers. See [Configure the Revision Style](#), on page 94.
- the revision summary file. See [Generate a Revision Summary](#), on page 95.

```
typedef struct tag_KVRevisionMark
{
    KVStructHeader;
    KV_RM_Title    InsTitle;
    KV_RM_Title    DelTitle;
    char           **ppAuthorStyles;
    int            nAuthorStyles;
    BOOL           bCreateSummary;
    char           *pszRevSumStartBlock;
    char           *pszRevSumEndBlock;
    int            nReserved;
    void           *pReserved;
}
KVRevisionMark;
```

Member Description

<code>KVStructHeader</code>	The KeyView version of the structure. See KVStructHead , on page 224.
<code>InsTitle</code>	The prefix and revision information for the <code><ins></code> tag, as defined by the <code>KV_RM_TITLE</code> structure in <code>kvtypes.h</code> . See KV_RM_Title , below.
<code>DelTitle</code>	The prefix and revision information for the <code></code> tag, as defined by the <code>KV_RM_TITLE</code> structure in <code>kvtypes.h</code> . See KV_RM_Title , below.
<code>ppAuthorStyles</code>	The HTML style you want applied to the revised content for a particular reviewer.
<code>nAuthorStyles</code>	The number of HTML styles to be defined.
<code>bCreateSummary</code>	When you set this flag, a revision summary file is created in the directory where the HTML output is generated. The default file name is <code>output_filename.revsum.htm</code> . You can change this file name by using the <code>fpGetAnchor</code> callback function. See GetAnchor() , on page 210.
<code>pszRevSumStartBlock</code>	The markup and tokens inserted at the beginning of the revision summary file.
<code>pszRevSumEndBlock</code>	The markup and tokens inserted at the end of the revision summary file.
<code>nReserved</code>	Reserved for internal use.
<code>pReserved</code>	Reserved for internal use.

KV_RM_Title

This structure defines the contents (prefix, reviewer name, date, and time) of the `title` attribute for the `InsTitle` and `DelTitle` members of `KVRevisionMark` (see [KVRevisionMark](#), on the previous page).

```
typedef struct tag_KV_RM_Title
{
    RM_Title_Flag    eFlag;
    BYTE             *pPrefix;
    int              nSize;
    KVCharSet        eCharSet;
}
KV_RM_Title;
```

Member Description

`eFlag` Specifies whether the reviewer name, date, and time appear in the `title` attribute. The

options are enumerated in `RM_Title_Flag` in `kvtypes.h`. See [RM_Title_Flag](#), on [page 276](#).

- `pPrefix` A pointer to the text string that is prefixed to the `eFlag` value in the `title` attribute of the `<ins>` or `` tags. By default, the string "inserted:" or "deleted:" is the first entry in the attribute.
- `nSize` The size of the prefix.
- `eCharSet` The character set of the prefix characters. The available character sets are enumerated in `KVCharSet` in `kvcharset.h`. See [Convert Character Sets](#), on [page 83](#).

If you set `eCharSet` to `KVCS_UNKNOWN`, the character set of the prefix is not converted and the prefix is written directly to the HTML output.

Chapter 11: Enumerated Types

This section provides information on some of the enumerated types used by the HTML Export API.

• Introduction	255
• ENDocAttributes	256
• ENSATableBorder	257
• KVCredKeyType	258
• KVErrorCode	258
• KVErrorCodeEx	260
• KVHTMLStyleSheetType	264
• KVHTMLAnchorTypeEx	264
• KVHTMLGraphicType	266
• KVHeadingCreateOptions	267
• KVMetadataType	267
• KVMetaNameType	269
• KVPartitionStartReason	269
• KVSumInfoType	271
• KVSumType	272
• LPDF_DIRECTION	275
• RM_Title_Flag	276

Introduction

The enumerated types are in `adinfo.h`, `kvcharset.h`, `kverrorcodes.h`, `kvtypes.h`, `kvhtml.h`, and `kvextract.h`. These header files are in the `include` directory. The first entry in an enumerated type structure should be set to zero (0). Each subsequent entry is increased by 1. For example, the first five entries of `KVCharSet` in `kvcharset.h` are:

```
KVCS_UNKNOWN
KVCS_SJIS
KVCS_GB
KVCS_BIG5
KVCS_KSC
```

They would be set in the following way:

Enumerated Type	Setting
KVCS_UNKNOWN	0
KVCS_SJIS	1
KVCS_GB	2
KVCS_BIG5	3
KVCS_KSC	4

You can also set many enumerated types by entering the appropriate symbolic constant, or TRUE or FALSE.

Programming Guidelines

When KeyView is enhanced in future releases, some enumerated types might be expanded. For example, new format IDs might be added to the `ENdocFmt` enumerated type, or new error codes might be added to the `KVErrorCodeEx` enumerated type. When you use these expandable types, your code should ensure binary compatibility with future releases.

For example, if you use an array to access error messages based on an error code, your code should check that the error code is less than `KVError_Last` before accessing the data. This ensures that new error codes are detected when you add KeyView binary files from new releases to your existing installation.

The following enumerated types are expandable:

`KVErrorCodeEx`

`KVMetadataType`

`KVCharSet`

`KVLanguageID`

`KVSubfileType`

`ENdocFmt`

ENDocAttributes

This enumerated type provides additional information about a file during auto-detection. This enumerated type is defined in `adinfo.h`.

NOTE: The attributes in this enumerated type are set when a particular characteristic is detected. However, if the attribute is not set it does not necessarily mean that the characteristic is not present. For example, KeyView sets `kEncrypted` when it detects encryption on the file, but if it does not detect encryption it does not necessarily mean the file is not encrypted.

Enumerators

<code>kEncrypted</code>	The file is encrypted.
<code>kWindowRMSEncrypted</code>	The file is encrypted with Windows RMS encryption.
<code>kBigEndian</code>	Where a format has big and little endian variants, this value indicates that this file is in the big endian variant.
<code>kLittleEndian</code>	Where a format has big and little endian variants, this value indicates that this file is in the little endian variant.
<code>k32Bit</code>	Where a format has 64- and 32-bit variants, this value indicates that this file is in the 32-bit variant.
<code>k64Bit</code>	Where a format has 64- and 32-bit variants, this value indicates that this file is in the 64-bit variant.

ENSATableBorder

This enumerated type defines the type of border to display around tables. This enumerated type is defined in `kvtypes.h`.

Definition

```
typedef enum tag_ENSATableBorder
{
    SA_BaseOnDocument,
    SA_NoBorder,
    SA_Border
}
ENSATableBorder;
```

Enumerators

<code>SA_BaseOnDocument</code>	Border type is based on the document.
<code>SA_NoBorder</code>	Table borders are always off.
<code>SA_Border</code>	Table borders are always on.

KVCredKeyType

This enumerated type defines the type of credential used to open a protected file. See [KVCredentialComponent](#), on page 152. This enumerated type is defined in `kvextract.h`.

Definition

```
typedef enum tag_KVCredKeyType
{
    KVCredKeyType_UserName,
    KVCredKeyType_UserIdFile,
    KVCredKeyType_Password,
}
KVCredKeyType;
```

Enumerators

KVCredKeyType_UserName	The credential in KVCredentialComponent is a user name.
KVCredKeyType_UserIdFile	The credential in KVCredentialComponent is a path to a file that contains user IDs.
KVCredKeyType_Password	The credential in KVCredentialComponent is a password.

KVErrorCode

This enumerated type defines the type of error generated if Export fails. This enumerated type is defined in `kverrorcodes.h`.

Definition

```
typedef enum tag_KVErrorCode
{
    KVERR_Success,                /* 0 Success*/
    KVERR_DLLNotFound,           /* 1 DLL or shared library not found*/
    KVERR_OutOfCore,             /* 2 memory allocation failure*/
    KVERR_processCancelled,      /* 3 fpContinue() returns FALSE*/
    KVERR_badInputStream,        /* 4 Invalid/corrupt input stream*/
}
```

```

KVERR_badOutputType,      /* 5  Invalid output type requested*/
KVERR_General,           /* 6  General error.... */
KVERR_FormatNotSupported, /* 7  Format not supported*/
KVERR_PasswordProtected, /* 8  File is Password Protected*/
KVERR_ADSSNotFound,     /* 9  Adobe Document Server not found*/
KVERR_AutoDetFail,      /* 10 Autodetect error*/
KVERR_AutoDetNoFormat,  /* 11 Unable to detect file format*/
KVERR_ReaderInitError,  /* 12 Error initializing the reader*/
KVERR_NoReader,         /* 13 No reader available for this format*/
KVERR_CreateOutputFileFailed, /* 14 Unable to create output file*/
KVERR_CreateTempFileFailed, /* 15 Unable to create temp file*/
KVERR_ErrorWritingToOutputFile, /* 16 Error writing to output file*/
KVERR_CreateProcessFailed, /* 17 Error creating a child process*/
KVERR_WaitForChildFailed, /* 18 Wait for child process failed*/
KVERR_ChildTimeOut,     /* 19 Child process hung / timed out*/
KVERR_ArchiveFileNotFound, /* 20 Attempt to extract nonexistent file*/
KVERR_ArchiveFatalError /* 21 Fatal error processing archive - should abort*/
}
KVErrCode;
    
```

Enumerators

KVERR_SUCCESS	The function completed successfully.
KVERR_DLLNotFound	A DLL or shared library was not found.
KVERR_OutOfCore	Memory allocation failure.
KVERR_processCancelled	The callback function fpContinue() returns FALSE.
KVERR_badInputStream	Invalid or corrupt input stream.
KVERR_badOutputType	Invalid output is requested.
KVERR_General	General error.
KVERR_FormatNotSupported	The file format is not supported.
KVERR_PasswordProtected	The file is encrypted or password-protected. KeyView supports only secure PST files.
KVERR_ADSSNotFound	Adobe Document Server not found. This error is obsolete.
KVERR_AutoDetFail	Autodetect error.
KVERR_AutoDetNoFormat	Unable to detect file format.
KVERR_ReaderInitError	Error initializing the reader.
KVERR_NoReader	No reader is available for this format.

KVERR_ CreateOutputFileFailed	Unable to create output file. This error is generated if the overwrite flag in KVExtractSubFileArg is FALSE, and a subfile has the same name as a file in the target path.
KVERR_ CreateTempFileFailed	Unable to create temporary file.
KVERR_ ErrorWritingToOutputFile	There was an error writing to the output file.
KVERR_ CreateProcessFailed	There was an error creating a child process.
KVERR_WaitForChildFailed	The wait for child process failed.
KVERR_ChildTimeOut	The child process hung or timed out.
KVERR_ ArchiveFileNotFound	Attempt to extract nonexistent file.
KVERR_ArchiveFatalError	A fatal error occurred processing an archive file.

KVErrorCodeEx

This enumerated type defines extended error codes. The type is defined in `kverrorcodes.h`.

Definition

```
typedef enum tag_KVErrorCodeEx
{
    KVErrors_OpenStreamFailure = KVERR_ArchiveFatalError + 1, /* 22 */
    KVErrors_InterfaceFunctionNotFound, /* 23 */
    KVErrors_InputFileNotFound, /* 24 */
    KVErrors_OpenOutputFileFailed, /* 25 */
    KVErrors_MemoryLeak, /* 26 */
    KVErrors_MemoryOverwrite, /* 27 */
    KVErrors_GPF, /* 28 */
    KVErrors_OopCore, /* 29 */
    KVErrors_KVoopLogFailed, /* 30 */
    KVErrors_OverNestedFileLimit, /* 31 */
    KVErrors_PSTAccessFailed, /* 32 */
    KVErrors_PasswordRequired, /* 33 */
    KVErrors_InvalidArgs, /* 34 */
    KVErrors_ReaderUsageDenied, /* 35 */
    KVErrors_OopBadConfig, /* 36 */
    KVErrors_OopBrokenPipe, /* 37 */
    KVErrors_OopPipeOEF, /* 38 */

```

```

    KVErrOr_IPCTimeOut,                /* 39 */
    KVErrOr_InvalidOopDriverSignature, /* 40 */
    KVErrOr_InvalidOopServiceSignature, /* 41 */
    KVErrOr_ZeroFile,                 /* 42 */
    KVErrOr_CompressionNotSupported,  /* 43 */
    KVErrOr_NoTemplates,               /* 44 */
    KVErrOr_NoMainTemplate,            /* 45 */
    KVErrOr_InvalidTemplate,           /* 46 */
    KVErrOr_TemplateError,             /* 47 */
    KVErrOr_IsADirectory,              /* 48 */
    KVErrOr_RMSEncryptionFailed,       /* 49 */
    KVErrOr_InvalidLicense,            /* 50 */
    KVErrOr_Last                       /* 51 */
}
KVErrOrCodeEx;

```

Enumerators

KVErrOr_OpenStreamFailure	Failed to open a stream during out-of-process filtering. This is an extended error for the KVERR_Genera1 code. This enumerator is used by KeyView Filter.
KVErrOr_InterfaceFunctionNotFound	An interface function was not found during out-of-process filtering. This is an extended error for the KVERR_Genera1 code. This enumerator is used by KeyView Filter.
KVErrOr_InputFileNotFound	Could not find the input file during out-of-process filtering. This is an extended error for the KVERR_Genera1 code. This enumerator is used by KeyView Filter.
KVErrOr_OpenOutputFileFailed	Could not open the output file during out-of-process filtering. This is an extended error for the KVERR_Genera1 code. This enumerator is used by KeyView Filter.
KVErrOr_MemoryLeak	A memory leak occurred during out-of-process filtering. This is an extended error for the KVERR_Genera1 code. This enumerator is used by KeyView Filter.
KVErrOr_MemoryOverwrite	A memory overwrite occurred during out-of-process filtering. This is an extended error for the KVERR_Genera1 code. This enumerator is used by KeyView Filter.
KVErrOr_GPF	An exception occurred during out-of-process filtering. This is an extended error for the KVERR_Genera1 code. This enumerator is used by KeyView Filter.
KVErrOr_OopCore	A memory dump was generated in a child process during out-of-process filtering. This is an extended error for the KVERR_Genera1 code. This enumerator is used by KeyView Filter.

KVErrors_KVoopLogFailed	The creation of the out-of-process error log failed. This is an extended error for the KVERR_General code. This enumerator is used by KeyView Filter.
KVErrors_OverNestedFileLimit	The container file has more than the allowable number of child documents. One or more child documents were not converted. Currently, this enumerator is not used.
KVErrors_PSTAccessFailed	<p>The PST file could not be converted. This error might be returned when a call to <code>fpOpenFile()</code> returns NULL for one of the following reasons:</p> <ul style="list-style-type: none"> • A Microsoft Outlook client is not installed. • A Microsoft Outlook client is installed, but is not the default email client. • A Microsoft Outlook client is installed, but is not configured correctly. • The PST file is corrupt. • The PST file is read-only (PST files must allow read and write access). • The MAPI call fails. • The bit editions of Microsoft Outlook do not match the bit editions of the KeyView software. <p>For example, if 32-bit KeyView is used, 32-bit Outlook must be installed. If 64-bit KeyView is used, 64-bit Outlook must be installed.</p>
KVErrors_PasswordRequired	To open the file, you must provide credentials. This error might be returned when a call to <code>fpOpenFile()</code> returns NULL.
KVErrors_InvalidArgs	The input argument or structure is invalid. This error is generated by the File Extraction APIs.
KVErrors_ReaderUsageDenied	<p>The current license key does not enable the document reader required to convert the file. This error might be returned when a call to <code>fpOpenFile()</code> returns NULL.</p> <p>Some document readers are considered advanced features and are licensed separately from the KeyView SDK (for example, the PST and MBX readers). Contact your Micro Focus sales representative to get an updated license key.</p>
KVErrors_OopBadConfig	Information in the <code>kvxconfig.ini</code> file is incomplete and cannot be used to filter the XML file. This is used by KeyView Filter.
KVErrors_OopBrokenPipe	Data was not transferred between the parent and child processes during out-of-process filtering because either the parent or child failed. This is used by KeyView Filter.

KVError_OopPipeOEF	Data was not transferred between the parent and child processes during out-of-process filtering because the parent process was shut down. This is used by KeyView Filter.
KVError_IPCTimeOut	Either the parent or child process is waiting for a reply or request during out-of-process filtering. This is used by KeyView Filter.
KVError_InvalidOopDriverSignature	A client sent a request to an out-of-process server, but the context driver does not exist on the server. This is used by KeyView Filter.
KVError_InvalidOopServiceSignature	A client sent a request to a File Extraction service that does not exist. If this error is generated on the call to <code>fpClose()</code> , you can ignore it. This is used by KeyView Filter.
KVError_ZeroFile	The input file is empty or zero bytes.
KVError_CompressionNotSupported	The file or subfile is compressed with an unsupported compression method.
KVError_NoTemplates	
KVError_NoMainTemplate	
KVError_InvalidTemplate	
KVError_TemplateError	
KVError_IsADirectory	
KVError_RMSDecryptionFailed	KeyView was not able to access the protected contents of an RMS file.
KVError_InvalidLicense	The license used to initialize KeyView is not valid for this operation.
KVError_Last	

Discussion

- When error reporting is enhanced in future releases, new error messages might be added to this enumerator type. When you use this type, your code must ensure binary compatibility with future releases. See [Programming Guidelines, on page 256](#).
- If an extended error code is called for a format to which the error does not apply, the `KVError_Last` code is returned.

KVHTMLStyleSheetType

This enumerated type defines the options for processing style sheet information. This enumerated type is defined in `kvhtml.h`.

Definition

```
typedef enum tag_KVHTMLStyleSheetType{    STYLESHEET_DISABLED = 0,  
    CSS_INLINE,  
    CSS_TOFILE  
}  
KVHTMLStyleSheetType;
```

Enumerators

STYLESHEET_DISABLED Disables Cascading Style Sheet (CSS) formatting.

CSS_INLINE Enables CSS formatting and adds style sheet information inline to the HTML output file.

CSS_TOFILE Enables CSS formatting, and generates an external file or uses an existing external file, which is referenced in a `<link...>` element. If **CSS_TOFILE** is set, you must use the `$(STYLESHEET)` token to specify the URL of the style sheet in the HTML output.

The `-c` option can be used in the `htmlini` sample program to specify the full path and file name of an external CSS file.

Applies to word processing documents only.

KVHTMLAnchorTypeEx

This enumerated type defines the anchor types for the output stream. This enumerated type is defined in `kvhtml.h`.

Definition

```
typedef enum tag_KVHTMLAnchorTypeEx  
{  
    VectorPictureAnchorEx = 0,
```



```
    RasterPictureAnchorEx,  
    H1AnchorEx,  
    H2AnchorEx,  
    H3AnchorEx,  
    H4AnchorEx,  
    H5AnchorEx,  
    H6AnchorEx,  
    XAnchorEx,  
    AnimatedGIFAnchorEx,  
    CSSAnchorEx,  
    GeneralAnchorEx,  
    DBAnchorEx,  
    JPEGAnchorEx  
}  
KVHTMLAnchorTypeEx;
```

Enumerators

VectorPictureAnchor	An anchor for embedded vector graphics.
RasterPictureAnchor	An anchor for embedded raster graphics.
H1Anchor	An anchor for level 1 heading blocks (H1).
H2Anchor	An anchor for level 2 heading blocks (H2).
H3Anchor	An anchor for level 3 heading blocks (H3).
H4Anchor	An anchor for level 4 heading blocks (H4).
H5Anchor	An anchor for level 5 heading blocks (H5).
H6Anchor	An anchor for level 6 heading blocks (H6).
XAnchor	An anchor for an external file.
AnimatedGIFAnchor	An anchor for embedded animated GIF graphics.
CSSAnchor	An anchor for an external CSS file.
GeneralAnchor	Reserved for future use.
DBAnchor	Used internally.
JPEGAnchor	An anchor for an embedded JPEG graphic.

KVHTMLGraphicType

This enumerated type defines graphic formats to which embedded graphics and presentations are converted. This enumerated type is defined in kvhtml.h.

Definition

```
typedef enum tag_KVHTMLGraphicType
{
    KVGFX_GIF,
    KVGFX_JPEG,
    KVGFX_PNG,
    KVGFX_CGM,
    KVGFX_WMF,
    KVGFX_JAVA,
    KVGFX_HTML,
    KVGFX_SVG
}
KVHTMLGraphicType;
```

Enumerators

- KVGFX_GIF Specifies GIF (Graphics Interchange Format) as the graphic type.
- KVGFX_JPEG Specifies JPEG (Joint Photographic Experts Group) as the graphic type.
- KVGFX_PNG Specifies PNG (Portable Network Graphics) as the graphic type.
- KVGFX_CGM Deprecated.
- KVGFX_WMF Specifies WMF (Windows Metafile) as the graphic type.
- KVGFX_JAVA Deprecated.
- KVGFX_HTML Specifies that text in presentations are converted to HTML.
- KVGFX_SVG Specifies SVG (Scalable Vector Graphics) as the graphic type. Only text in vector graphics is included in SVG output.

NOTE: Text inside charts in presentation graphic files are not output to SVG.

KVHeadingCreateOptions

This enumerated type defines whether Export generates blocks and block chunks based only on the heading styles defined in a source document (if they are available), or based on both the source document's heading styles and headings that are created automatically by Export. Headings that are created automatically by Export are based on the text attributes of the source document as defined by `KVHTMLHeadingInfo`. This enumerated type is defined in `kvhtml.h`.

Definition

```
typedef enum tag_KVHeadingCreateOptions
{
    KVHC_DocHeadingsOnly,
    KVHC_CreateHeadingsAlways
}
KVHeadingCreateOptions;
```

Enumerators

`KVHC_DocHeadingsOnly` This instructs Export to rely exclusively on heading styles defined in the source document. However, if the source document does not contain heading styles, Export generates blocks on its own using the criteria defined by the structure `KVHeadingInfo`.

`KVHC_CreateHeadingsAlways` This instructs Export to use the heading styles in the source document when available, and to also automatically create table of contents entries based on the criteria defined by the structure `KVHeadingInfo`.

KVMetadataType

This enumerated type defines the data type of metadata that can be extracted from a subfile in a mail message or mail store. If a metadata field has a corresponding `KeyView` type in `KVMetadataType`, the metadata is converted to the `KVMetadataElem` structure, and the structure member `isValid` is 1. This enumerated type is defined in `kvtypes.h`.

Definition

```
typedef enum
{
    KVMetadata_Unknown = 0,
```

```
KVMetadata_Bool           = 1,  
KVMetadata_Binary        = 2,  
KVMetadata_Int4          = 3,  
KVMetadata_UInt4         = 4,  
KVMetadata_Int8          = 5,  
KVMetadata_UInt8         = 6,  
KVMetadata_String        = 7,  
KVMetadata_Unicode       = 8,  
KVMetadata_DateTime      = 9,  
KVMetadata_Float         = 10,  
KVMetadata_Double        = 11,  
KVMetadata_Last  
}  
KVMetadataType;
```

Enumerators

KVMetadata_Unknown	The value in the property is of an unknown type.
KVMetadata_Bool	The value in the property is a Boolean value. The corresponding MAPI type is PT_BOOLEAN.
KVMetadata_Binary	The value in the property is a byte array. The corresponding MAPI type is PT_BINARY.
KVMetadata_Int4	The value in the property is a signed 4-byte integer. The corresponding MAPI types are PT_I2, PT_SHORT, PT_I4, and PT_LONG.
KVMetadata_UInt4	The value in the property is an unsigned 4-byte integer. This type is not currently supported.
KVMetadata_Int8	The value in the property is a signed 8-byte integer. This type is not currently supported.
KVMetadata_UInt8	The value in the property is an unsigned 8-byte integer. This type is not currently supported.
KVMetadata_String	The value in the property is a string. The corresponding MAPI type is PT_STRING8.
KVMetadata_Unicode	The value in the property is a Unicode string. The corresponding MAPI type is PT_UNICODE.
KVMetadata_DateTime	The value in the property is a date and time. The corresponding MAPI type is PT_SYSTIME.
KVMetadata_Float	The value in the property is a 4-byte float. The corresponding MAPI type is PT_FLOAT.
KVMetadata_Double	The value in the property is an 8-byte double. The corresponding MAPI type is PT_DOUBLE.

Discussion

New types might be added to this enumerated type. When you use this type, your code should ensure binary compatibility with future releases. See [Programming Guidelines, on page 256](#).

KVMetaNameType

This enumerated type defines the type of metadata fields extracted from a subfile in a mail message or mail store. See [KVMetaName, on page 159](#). This enumerated type is defined in `kvextract.h`.

Definition

```
typedef enum
{
    KVMetaNameType_Integer = 0,
    KVMetaNameType_String  = 1
}
KVMetaNameType;
```

Enumerators

`KVMetaNameType_Integer` The metadata field is an integer.

`KVMetaNameType_String` The metadata field is a string.

KVPartitionStartReason

This enumerated type defines the reasons for starting a new partition. This enumerated type is defined in `kvpartitions.h`. For more information, see [Partitioning, on page 119](#).

Definition

```
typedef enum tag_KVPartitionStartReason
{
    KVPartition_Invalid,
    KVPartition_PGStart,
    KVPartition_SSStart,
    KVPartition_WPStart,
    KVPartition_FormatStandard,
}
```

```
    KVPartition_Heading,  
    KVPartition_HardBreak,  
    KVPartition_BlockSize,  
    KVPartition_PageSizeChange  
}  
KVPartitionStartReason;
```

Enumerators

KVPartition_Invalid	Used internally.
KVPartition_PGStart	The first partition of a document that was converted by using the presentation graphic structured access layer.
KVPartition_SSSStart	The first partition of a document that was converted by using the spreadsheet structured access layer.
KVPartition_WPStart	The first partition of a document that was converted by using the word processing structured access layer.
KVPartition_FormatStandard	<p>The format standard start reason. This start reason applies only to documents that were converted by using the presentation graphic or spreadsheet structured access layers. The format standard start reason is:</p> <ul style="list-style-type: none">• a new worksheet for spreadsheet formats• a table for database formats• a slide for presentation graphic formats• a graphic for image/graphic formats <p>Export starts a new partition for this reason only if <code>bPutBlocksInSeparateFiles</code> is set to <code>TRUE</code>. See KVHTMLTemplateEx, on page 246.</p>
KVPartition_Heading	A heading in a Word Processing document.
KVPartition_HardBreak	A hard page break in a Word Processing document.
KVPartition_BlockSize	The block size limit was reached.
KVPartition_PageSizeChange	A page size change in a Word Processing document.

KVSumInfoType

This enumerated type defines the data type of the metadata field extracted from a document. This enumerated type is defined in `kvtypes.h`.

Definition

```
typedef enum tag_KVSumInfoType
{
    KV_String          = 0x1,
    KV_Int4            = 0x2,
    KV_DateTime       = 0x3,
    KV_ClipBoard      = 0x4,
    KV_Bool           = 0x5,
    KV_Unicode        = 0x6,
    KV_IEEE8          = 0x7,
    KV_Other          = 0x8
}
KVSumInfoType;
```

Enumerators

- `KV_String` The value in the metadata field is a string.
- `KV_Int4` The value in the metadata field is an integer.
- `KV_DateTime` The value in the metadata field is a date and time. This type is a 64-bit value representing the number of 100-nanosecond intervals since January 1, 1601 (Windows FILETIME EPOCH). You might need to convert this value into another format.
- `KV_ClipBoard` Currently not supported.
- `KV_Bool` The value in the metadata field is a Boolean value.
- `KV_Unicode` The value in the metadata field is a Unicode string.
- `KV_IEEE8` The value in the metadata field is an IEEE 8-byte integer.
- `KV_Other` The value in the metadata field is user-defined.

KVSumType

This enumerated type defines the metadata fields that can be extracted from a document. This enumerated type is defined in `kvtypes.h`.

- Types 0 to 34 and type 42 are Office summary fields.
- Types 35 to 40 are computer-aided design (CAD) metadata fields.
- Type 41, `KV_OrigAppVersion`, is shared by Office software and CAD.

Types 43 or greater are reserved for any non-standard metadata field defined in a document.

Definition

```
typedef enum tag_KVSumType
```

```
    KV_CodePage           = 0,  
    KV_Title              = 1,  
    KV_Subject            = 2,  
    KV_Author             = 3,  
    KV_Keywords           = 4,  
    KV_Comments           = 5,  
    KV_Template           = 6,  
    KV_LastAuthor         = 7,  
    KV_RevNumber          = 8,  
    KV_EditTime           = 9,  
    KV_LastPrinted        = 10,  
    KV_Create_DTM         = 11,  
    KV_LastSave_DTM       = 12,  
    KV_PageCount          = 13,  
    KV_WordCount          = 14,  
    KV_CharCount          = 15,  
    KV_ThumbNail          = 16,  
    KV_AppName            = 17,  
    KV_Security           = 18,  
    KV_Category           = 19,  
    KV_PresentationTarget = 20,  
    KV_Bytes               = 21,  
    KV_Lines               = 22,  
    KV_Paragraphs         = 23,  
    KV_Slides              = 24,  
    KV_Notes              = 25,  
    KV_HiddenSlides       = 26,  
    KV_MMClips            = 27,  
    KV_ScaleCrop          = 28,  
    KV_HeadingPairs       = 29,
```



```
KV_TitlesofParts      = 30,  
KV_Manager           = 31,  
KV_Company           = 32,  
KV_LinksUpToDate     = 33,  
KV_HyperlinkBase     = 34,  
KV_Layouts           = 35,  
KV_Objects            = 36,  
KV_FileVersion        = 37,  
KV_LastFileVersion   = 38,  
KV_OrigFileVersion   = 39,  
KV_OrigFileType       = 40,  
KV_OrigAppVersion    = 41,  
KV_ContentStatus     = 42,  
KV_UserDefined        = 43  
}  
KVSumType;
```

Enumerators

KV_CodePage	The code page of the document.
KV_Title	The contents of the "Title" property field taken from the source document.
KV_Subject	The contents of the "Subject" property field taken from the source document.
KV_Author	The contents of the "Author" property field taken from the source document.
KV_Keywords	The contents of the "Keywords" property field taken from the source document.
KV_Comments	The contents of the "Comments" property field taken from the source document.
KV_Template	The contents of the "Template" property field taken from the source document.
KV_LastSavedby	The contents of the "Last saved by" property field taken from the source document.
KV_RevNumber	The contents of the "Revision number" property field taken from the source document.
KV_EditTime	The contents of the "Total editing time" property field taken from the source document.
KV_LastPrinted	The contents of the "Printed" property field taken from the source document.
KV_Create_DTM	The contents of the "Created" property field taken from the source document.
KV_LastSave_DTM	The contents of the "Modified" property field taken from the source document.

	document.
KV_PageCount	The contents of the "Pages" property field taken from the source document. The field provides the number of pages in the document.
KV_WordCount	The contents of the "Words" property field taken from the source document. The field provides the number of words in the document.
KV_CharCount	The contents of the "Characters" property field taken from the source document. The field provides the number of characters in the document.
KV_ThumbNail	A thumbnail image of a document.
KV_AppName	The contents of the "Type" property field taken from the source document. This field identifies the application used to read the document.
KV_Security	The contents of the "Attributes" property field taken from the source document.
KV_Category	The contents of the "Category" property field taken from the source document.
KV_PresentationTarget	The target format for presentations (35mm, printer, video, and so on).
KV_Bytes	The contents of the "Size" property field taken from the source document. The field provides the size of the file in bytes.
KV_Lines	The contents of the "Lines" property field taken from the source document. The field provides the number of lines in the document.
KV_Paragraphs	The contents of the "Paragraphs" property field taken from the source document. The field provides the number of paragraphs in the document.
KV_Slides	The contents of the "Slides" property field taken from a presentation document. The field provides the number of slides in the document.
KV_Notes	The contents of the "Notes" property field taken from a presentation document. The field provides the number of notes in the document.
KV_HiddenSlides	The contents of the "Hidden slides" property field taken from a presentation document. The field provides the number of hidden slides in the document.
KV_MMClips	The contents of the "Multimedia clips" property field taken from a presentation document. The field provides the number of multimedia clips in the document.
KV_ScaleCrop	A Boolean value that specifies whether thumbnails are cropped or scaled.
KV_HeadingPairs	An internally-used property indicating the grouping of different document parts and the number of items in each group.
KV_TitlesofParts	The contents of the "Document Contents" property field taken from the source document. The field contains a list of the parts of the file, such as the names of macro sheets in Microsoft Excel or the headings in Word.

KV_Manager	The contents of the "Manager" property field taken from the source document.
KV_Company	The contents of the "Company" property field taken from the source document.
KV_LinksUpToDate	A Boolean value that specifies whether links in the document are resolved and current.
KV_HyperlinkBase	The base address used for all relative links in the file.
KV_Layouts	The number of layouts in the AutoCAD drawing.
KV_Objects	The approximate number of objects in the AutoCAD drawing.
KV_FileVersion	The AutoCAD version (for example, R13, R14) of the drawing.
KV_LastFileVersion	The AutoCAD version (for example, R13, R14) that the AutoCAD drawing was last saved as.
KV_OrigFileVersion	The AutoCAD version (for example, R13, R14) of the original source file.
KV_OrigFileType	The AutoCAD file type (for example, DWG, DXF, or DWB) of the original source file.
KV_OrigAppVersion	The AutoCAD version (for example, R13, R14) of the application that created the original source file.
KV_ContentStatus	The status of the content, for example <i>Draft</i> , <i>Reviewed</i> , or <i>Final</i> .
KV_UserDefined	The contents of the first entry in the array of non-standard metadata. This could be user-defined metadata, or metadata unique to a file type.

LPDF_DIRECTION

This enumerated type defines the paragraph direction of extracted paragraphs from a PDF file when logical order is enabled. This enumerated type is defined in `kvtypes.h`.

Definition

```
typedef enum{
    LPDF_RAW = 0,
    LPDF_LTR,
    LPDF_RTL,
    LPDF_AUTO
} LPDF_DIRECTION ;
```

Enumerators

LPDF_ RAW Unstructured paragraph flow. This is the default behavior.

LPDF_ LTR Logical reading order and left-to-right paragraph direction.

LPDF_ RTL Logical reading order and right-to-left paragraph direction.

LPDF_ AUTO Logical reading order. The PDF reader determines the paragraph direction for each PDF page, and then sets the direction accordingly. This is the default when logical order is enabled.

RM_Title_Flag

This enumerated type defines the information that appears in the `title` attribute in the `<ins>` and `` tags for the `eFlag` member of the `KV_RM_Title` structure. This applies when revision information is enabled and included in the HTML output.

Definition

```
typedef enum  
{  
    RMT_Off = 0,  
    RMT_Author,  
    RMT_Datetime,  
    RMT_AuthorDatetime  
}
```

`RM_Title_Flag;`

Enumerators

RMT_Off A `title` attribute is not included in the `<ins>` and `` tags. This would generate markup similar to the following:

```
<ins cite="mailto:JohnD"  
datetime="2006-04-24T14:47:00">This  
text was added</ins>
```

RMT_Author	<p>The reviewer's name is generated in the title attribute of the <ins> and tags. This would generate markup similar to the following:</p> <pre><ins title="Inserted: JohnD" cite="mailto:JohnD" datetime="2006-04-24T14:47:00">This text was added</ins></pre>
RMT_Datetime	<p>The date and time is included in the title attribute of the <ins> and tags. The date is in ISO-8601 format: YYYY-MM-DDThh:mm:ss. This would generate markup similar to the following:</p> <pre><ins title="Inserted: 2006-04-24T14:47:00" cite="mailto:JohnD" datetime="2006-04-24T14:47:00">This text was added</ins></pre>
RMT_AuthorDatetime	<p>The reviewer's name, date, and time are included in the title attribute of the <ins> and tags. This would generate markup similar to the following:</p> <pre><ins title="Inserted: JohnD, 2006-04-24T14:47:00" cite="mailto:JohnD" datetime="2006-04-24T14:47:00">This text was added</ins></pre> <p>This is the default.</p>

Part 4: COM API Reference

This section provides detailed reference information for the COM implementation of the HTML Export API.

- [COM Interface Methods and Events](#)
- [COM Interface Properties](#)

Chapter 12: COM Interface Methods and Events

This section describes the methods that HTML Export uses to manage the input and output streams, and to perform the actual document conversion. It also describes the events that allow the calling application to monitor and affect the HTML conversion while it is in progress.

The methods' syntax are described as they would be used from within Visual Basic, where HTM is the COM Automation Server object. The events are described with the Interface Description Language (IDL). See the Template Wizard or `comsamp` sample programs for examples of how to use the events from Visual Basic.

Methods

- [AddStyleMapping](#), below
- [ConvertFileToFile](#), on the next page
- [GetFileInfo](#), on the next page
- [GetStyleMapping](#), on page 281
- [GetSummaryInfo](#), on page 281
- [RemoveStyleMapping](#), on page 282
- [Unload](#), on page 282
- [UpdateFromIniFile](#), on page 282
- [HTMLConfig](#), on page 283

Events

- [Continue](#), on page 283
- [UserCallback](#), on page 283

AddStyleMapping

This method maps a character or paragraph style to arbitrary markup. See [Map Styles](#), on page 87 for more information on style mapping.

```
HTM.AddStyleMapping(StyleName, MarkupStart, MarkupEnd, nFlags)
```

where:

- `StyleName` is the name of the word processing style (for example, "Heading 1") to which style mapping is applied. Style names are case sensitive.
- `MarkupStart` is the markup to be added at the beginning of the content (for example, `<h1>`).
- `MarkupEnd` is the markup to be added at the end of the content (for example, `<\h1>`).
- `nFlags` is the flag set for this markup. A flag specifies how the content associated with the style should be processed. Possible values are enumerated in `kvtypes.h`. See [Flags for Defining Styles, on page 89](#) for a description of the flags.

NOTE: By default, HTML Export maps the heading style "Heading 1" to `<h1></h1>`, and so on, for heading levels 1 through 6. If you use style mappings, the default mapping is overridden. Therefore, you must supply markup for *all* heading levels. HTML Export uses heading levels to define the overall structure of the HTML output.

ConvertFileToFile

This method converts a specified file to HTML.

```
nRet = HTM.ConvertFileToFile(szTargetFile)
```

where:

- `szTargetFile` is the complete path and file name of the HTML output.
- `nRet` is the return error code as defined in the `KVErrorCode` enumerated type defined in `kverrorcodes.h`.

GetFileInfo

This method retrieves information about the source file (as defined in the `pszInputFile` property).

```
HTM.GetFileInfo(lcharSet, ldocClass, ldocFmt, ldocVersion,  
ldocAttributes)
```

where:

- `lcharSet` is the same as the `InputCharSet` property
- `docClass` is the same as the `adInfo_docClass` property
- `ldocFmt` is the same as the `adInfo_docFmt` property
- `ldocVersion` is the same as the `adInfo_docVersion` property
- `ldocAttributes` is the same as the `bAllowHeadingsInTables` property

See [COM Interface Properties, on page 284](#) for a description of these properties.

NOTE: This method fills in all of these parameters (long) based on the source document.

GetStyleMapping

This method gets the formatting specifically assigned to various styles.

```
HTM.GetStyleMapping(nItem, StyleName, MarkupStart, MarkupEnd,  
nFlags)
```

See [AddStyleMapping, on page 279](#) for a description of `StyleName`, `MarkupStart`, `MarkupEnd`, and `nFlags`.

By specifying `nItem` (which can be any value from 0 to `NumStyles - 1` where `pszBaseUrl` is a property), the `StyleName`, `MarkupStart`, `MarkupEnd`, and `nFlags` parameters are filled in.

GetSummaryInfo

This method retrieves metadata from the input file.

```
HTM.GetSummaryInfo(nItem, lTotalItems, lValid, lType, lVal, szVal, szValUser)
```

where:

- `nItem` is an integer which is the metadata item number. See `KVSumType` in `kvtypes.h` for a list of values.

For example, `KV_Author` is value 3, so setting `nItem` to 3 would retrieve the Author of the source document if this information was available. This is identical to using the `pszAuthor` property (some common metadata items are exposed as properties as well as being accessible through this method).
- `lTotalItems` is a long which is returned to give the total number of metadata items possible. This is 34 for most documents (as defined in `KVSumType` in `kvtypes.h`), although all 34 might not be valid (see `lValid` parameter). If there is user-defined metadata available, `lTotalItems` might be greater than 34.
- `lValid` is a long which is 0 if the item is invalid (not available) and 1 if the information associated with this item is available.
- `lType` is a long which corresponds to the `KVSumInfoType` enumerated type defined in `kvtypes.h`. A value of 1 indicates that `szVal` contains the string associated with this item (if `lValid` is also 1). A value of 2 indicates that `lVal` contains a long associated with this item (if `lValid` is also 1). See [KVSumType, on page 272](#).
- `szValUser` is a string description of the metadata item.

Sample Code

The following code from the comsmp sample program demonstrates how to use the `GetSummaryInfo` method:

```
Dim nTotal As Long
Dim nValid As Long
Dim nType As Long
Dim nVal As Long
Dim szVal As String
Dim szUserVal As String
On Error GoTo Handler
' Get the Author if available (item 3 is the Author. See KVSumType
' in kvtypes.h for a list of items and their values)
Call MyRef.GetSummaryInfo(3, nTotal, nValid, nType, nVal, szVal, szUserVal)
MsgBox szUserVal & " = " & szVal
```

RemoveStyleMapping

This method disables an instance of style mapping.

```
HTM.RemoveStyleMapping(nItem)
```

where:

- `nItem` is the style mapping item to remove (See [GetStyleMapping, on the previous page](#)).

Unload

This method unloads the `htmserv` object.

```
HTM.Unload()
```

This method applies only to the out-of-process COM object and normally is not necessary. Note that using this method forces an unload, even if the object's reference count is not zero.

UpdateFromIniFile

This method updates parameters from the template file.

```
HTM.UpdateFromIniFile(szIniFile)
```

where:

- `szIniFile` is the complete path and file name of a supplied template file (see the directory `install\htmllexport\programs\ini` for examples of template files).

HTMLConfig

This method provides a way to configure options prior to document conversion. Currently, the function is used to specify a PDF reader. For more information, see [Convert PDF Files to Raster Images, on page 98](#).

```
HTM.HTMLConfig(nType, nValue, p)
```

where:

- `nType` is a symbolic constant defined in `kvhtml.h` and used to configure options. Currently, you can set this to `KVCFG_SETHIFIPDF`. This option specifies that the graphic-based PDF reader (`kppdfldr`) is used to convert PDF documents. See [Convert PDF Files to Raster Images, on page 98](#).
- `nValue` is an integer value defined for the above type.
- `p` is reserved, and must be `NULL`.

The `comsamp` sample program demonstrates how to use this method. See [comsamp, on page 138](#).

Continue

This event has two purposes: to enable the calling process to monitor the progress of the HTML conversion, and to provide a way of terminating a conversion before it is completed.

```
Continue([in] int PercentDone,  
         [out, retval] int *bQuit);
```

The sample program `comsamp` demonstrates how to use this event.

UserCallback

This event allows the calling process to insert optional data into selected points of the HTML output. This event is triggered by the inclusion of the `$USERCB=X` token in one of the properties, where `X` identifies the callback. The text in `szUserString` is inserted in the HTML. See [\\$USERCB, on page 453](#).

```
UserCallback([in] BSTR szUserString,  
            [out, retval] BSTR *pszVal);
```

The `comsamp` sample program demonstrates how to use this event.

Chapter 13: COM Interface Properties

This section contains an alphabetized list of all the properties in the COM Interface.

Some of the descriptions refer to enumerated types in `adinfo.h`, `kvcharset.h`, `kvhtml.h`, or `kvtypes.h`. These header files are located in the `include` directory. See [Enumerated Types, on page 255](#) for more information on enumerated types.

Some of the classes use HTML Export tokens. See [Export Tokens, on page 451](#) for a description of these tokens.

`adInfo_docAttributes`

This is a read-only property.

The attributes of the source document. The document attributes are enumerated in `ENdocAttributes` of `adinfo.h`:

- `kEncrypted`
- `kMacBinaryEncoded`
- `kAppleSingleEncoded`
- `kAppleDoubleEncoded`
- `kWangGDIEncoded`

`adInfo_docClass`

This is a read-only property.

The class of the source document. The format classes are enumerated in `ENdocClass` of `adinfo.h`.

A value of `-1` indicates that HTML Export encountered an error while attempting to detect the class of the source document. Zero (`0`) indicates that HTML Export is unable to determine the format of the source document.

`adInfo_docFmt`

This is a read-only property.

The format of the source document. This information determines which document reader is used to generate stream information during the conversion. The formats are enumerated in `ENdocFmt` of `adinfo.h`.

adInfo_docVersion

This is a read-only property.

The version of the source document's format.

This property is a long integer corresponding to the version number of the format `version# * 1000`. For example, version number 1.02 would be 1020.

bAllowHeadingsInTables

This is a read and write property.

This property determines whether or not the contents of tables are considered for automatic heading generation. If you set `bAllowHeadingsInTables` to `TRUE`, HTML Export considers converting the contents of tables to headings in the HTML output.

See [headingCreateType, on page 293](#) for more information on automatic generation of headings.

This property applies to word processing documents and spreadsheets only.

bDisplayRelativeFontSize

This is a read and write property.

Set `bDisplayRelativeFontSize` to `TRUE` to use relative font size tags in the HTML output. For example, the tag `` adds one to the base font size, which is normally three.

bEnableEmptyRows

This is a read and write property.

Set `bEnableEmptyRows` to `TRUE` to display empty rows in a spreadsheet format. If you set `bEnableEmptyRows` to `FALSE`, empty rows are not displayed. This property applies only to 20 or more consecutive empty rows. The default is `FALSE`.

This property applies to spreadsheets only.

bForceOutputCharSet

This is a read and write property.

Set `bForceOutputCharSet` to **TRUE** to use the output character set specified in `OutputCharSet`, regardless of the internal document information or the source character set specified by `SrcCharSet`.

See [Convert Character Sets, on page 83](#) for more information on character set mapping.

NOTE: Forcing a character set to `KVCS_UNKNOWN` is always ignored.

bForceSrcCharSet

This is a read and write property.

Set `bForceSrcCharSet` to **TRUE** to use the source character set specified in `SrcCharSet`, regardless of the internal document information.

See [Convert Character Sets, on page 83](#) for more information on character set mapping.

NOTE: Forcing a character set to `KVCS_UNKNOWN` is always ignored.

bGenerateURLs

This is a read and write property.

Set `bGenerateURLs` to **TRUE** to add anchor tags (`<a ...>`) to text starting with "www", "http:", or "file:".

This property applies to word processing documents only.

bHardPageMakesNewBlock

This is a read and write property.

Set `bHardPageMakesNewBlock` to **TRUE** to have hard page breaks in the source document generate new HTML files during the conversion process. `pszChunkTemplate` provides the appropriate table of contents entry for the new block. See [pszChunkTemplate, on page 302](#).

This property applies to word processing documents and spreadsheets only.

bNbspEmptyCells

This is a read and write property.

Set `bNbspEmptyCells` to **TRUE** to include a non-breaking space (`<td> </td>`) in the markup for empty table cells in the source document. If you set `bNbspEmptyCells` to **FALSE**, `<td></td>` is generated for empty table cells.

This property applies to word processing documents and spreadsheets only.

bNoPictures

This is a read and write property.

Set `bNoPictures` to **TRUE** to generate verbose markup only. Embedded graphics are not generated as separate files, image tags are not included in the output, and CSS files do not work.

If you set `bNoPictures` to **FALSE**, embedded graphics in a document are regenerated as separate files, stored in the output directory, and image tags are included in the output.

To output graphics for presentations, you must set `bNoPictures` to **FALSE**, and set `bRasterizeFiles` to **TRUE**.

To use CSS files, you must set `bNoPictures` to **FALSE** and use the `KVHTMLSetStyleSheet()` function to request the CSS file (see [Use Style Sheets, on page 90](#)).

bPutBlocksInSeparateFiles

This is a read and write property.

Set `bPutBlocksInSeparateFiles` to **TRUE** to create a separate HTML file for each heading level 1 block. Each new block uses the markup defined in `pszStartBlock` and `pszEndBlock`. See [pszStartBlock, on page 306](#) and [pszEndBlock, on page 302](#). If you set `bPutBlocksInSeparateFiles` to **FALSE**, each heading level 1 block is placed sequentially in the same file, after the initial markup is written.

bRasterizeFiles

This is a read and write property.

Set `bRasterizeFiles` to **TRUE** to rasterize slides from presentations into single images. For this setting to take effect, you must also set the `bNoPictures` property to **FALSE**. The format the images are converted to is determined by the `OutputRasterGraphicType` property.

Set `bRasterizeFiles` to **FALSE** to convert the text in slides to HTML. When you set this property to **FALSE**, images do not appear in the HTML output.

bRemoveEmptyColumns

This is a read and write property.

Set `bRemoveEmptyColumns` to **TRUE** to remove spreadsheet columns that do not contain data and to disable cell merge. The default is **FALSE**.

This property applies to spreadsheets only.

bRemoveFileNameSpaces

This is a read and write property.

Set `bRemoveFileNameSpaces` to **TRUE** to remove spaces from generated output file names.

bSupportCellSpan

This is a read and write property.

Set `bSupportCellSpan` to **TRUE** to include `colspan="n"` markup in the output. If text in the source document spans across empty columns, and `bSupportCellSpan` is enabled, the text is output across columns in the HTML. If this option is disabled, text that spans across columns is output in a single cell. This property applies to spreadsheets only. The default value is **FALSE**.

bSupportColumnHeadings

This is a read and write property.

Set `bSupportColumnHeadings` to **TRUE** to include column headings from the source spreadsheet in the HTML output. This property applies to spreadsheets only. The default is **FALSE**.

bSupportColumnWidth

This is a read and write property.

Set `bSupportColumnWidth` to **TRUE** to include column width data from the source spreadsheet in the HTML output. This property applies to spreadsheets only. The default value is **FALSE**.

bSupportFontFace

This is a read and write property.

Set `bSupportFontFace` to **TRUE** to retain the font face information contained in the source document. If you set `bSupportFontFace` to **FALSE**, no `FACE` attributes appear in the `` tags of the HTML output.

bSupportRFC1942_cols

This is a read and write property.

Set `bSupportRFC1942_cols` to **TRUE** to include `cols=x` specifications in the `<table>` tags of the HTML output markup.

bSupportRowHeadings

This is a read and write property.

Set `bSupportRowHeadings` to **TRUE** to include row headings from the source spreadsheet in the HTML output. This property applies to spreadsheets only. The default is **FALSE**.

bSupportRowSpan

This is a read and write property.

Set `bSupportRowSpan` to **TRUE** to include row span data from the source spreadsheet in the HTML output. This property applies to spreadsheets only. The default value is **FALSE**.

bSupportUserFontSizeMapping

This is a read and write property.

Set `bSupportUserFontSizeMapping` to **TRUE** to use the font sizes specified in the `FontSizeMap` (see [FontSizeMap_nSize\[1...7\]](#), on page 293). If you set `bSupportUserFontSizeMapping` to **FALSE**, HTML Export uses default `SIZE` attributes.

bTableHTMLForSpreadsheetOnly

This is a read and write property.

Set `bTableHTMLForSpreadsheetOnly` to **TRUE** to control how spreadsheets are displayed in the HTML output. If you set `bTableHTMLForSpreadsheetOnly` to **FALSE**, cell color and border information from the source document is used. Use this parameter in conjunction with `pszTableHTML`.

bTabsToTables

This is a read and write property.

Set `bTabsToTables` to **TRUE** to convert tabbed columns to tables. This property applies to word processing documents only.

bUseDocumentColors

This is a read and write property.

Set `bUseDocumentColors` to **TRUE** to retain the color attributes information contained in the source document. If you set `bUseDocumentColors` to **FALSE**, no color attributes appear in the `` tags of the HTML output.

bUseDocumentFontInfo

This is a read and write property.

Set `bUseDocumentFontInfo` to **TRUE** to retain the font information contained in the source document. If you set `bUseDocumentFontInfo` to **FALSE**, no font information appears in the `` tags in the HTML output.

CodePage

This is a read-only property.

The character encoding of the document if available.

See [GetSummaryInfo](#), on page 281 for more information on all metadata that you can obtain from a document.

cRedact

This is a read and write property.

The character used to replace tagged text designated through style mapping to be omitted from the HTML output. This functionality is useful when you need to hide confidential or sensitive information. The default replacement character is "X".

The specified character is used for all text that is mapped to a style which is processed by using the `KVSTYLE_REDACT` flag (defined in `kvtypes.h`). See [Flags for Defining Styles, on page 89](#) for more information on style mapping and the REDACT flag.

This property applies to word processing documents only.

cReplaceChar

This is a read and write property.

The character used when a character in the source document's character set cannot be mapped to the output character set. The default replacement character is a question mark (?).

cxVectorToRasterXRes

This is a read and write property.

This property controls the horizontal resolution at which presentations and vector graphics are converted. The default value is 0, which means that HTML Export retains the original resolution.

This property is set in conjunction with [cyVectorToRasterYRes, on the next page](#).

You can specify the resolution as an absolute size in pixels, or as a proportion of the original size.

KeyView always maintains the aspect ratio of the original graphic and does not increase the resolution. If you set values that would enlarge a graphic, KeyView only changes the size of the HTML element.

To set the resolution in pixels

To specify the resolution in pixels, specify the width (`cxVectorToRasterXRes`) and/or height (`cyVectorToRasterYRes`).

To export the largest image that fits within a bounding box, without changing the original aspect ratio, set both the width and height. For example, to export the largest image that fits in an 800x500 bounding box:

```
cxVectorToRasterXRes=800  
cyVextorToRasterYRes=500
```

Alternatively you can fix one of the dimensions. Set one value and set the other to zero. For example, to export images with a height of 1500 pixels and whatever width is necessary to maintain the original aspect ratio:

```
cxVectorToRasterXRes=0  
cyVextorToRasterYRes=1500
```

The maximum size permitted for either dimension is 4000 pixels.

To set the resolution proportionally

To set the resolution proportionally, set `cxVectorToRasterXRes` to a negative value. A negative value represents a percentage of the original resolution. Set `cyVectorToRasterYRes` to 0 (zero). Negative (percentage) values for `cyVectorToRasterYRes` are ignored.

The following example exports a graphic at 50 percent of its original resolution:

```
cxVectorToRasterXRes=-50  
cyVectorToRasterYRes=0
```

cyVectorToRasterYRes

This is a read and write property.

This property controls the vertical resolution at which presentations and vector graphics are converted. The default value is 0, which means HTML Export retains the original resolution.

This property is set in conjunction with [cxVectorToRasterXRes, on the previous page](#).

You can specify the resolution as an absolute size in pixels, or as a proportion of the original size.

KeyView always maintains the aspect ratio of the original graphic and does not increase the resolution. If you set values that would enlarge a graphic, KeyView only changes the size of the HTML element.

To set the resolution in pixels

To specify the resolution in pixels, specify the width (`cxVectorToRasterXRes`) and/or height (`cyVectorToRasterYRes`).

To export the largest image that fits within a bounding box, without changing the original aspect ratio, set both the width and height. For example, to export the largest image that fits in an 800x500 bounding box:

```
cxVectorToRasterXRes=800  
cyVextorToRasterYRes=500
```

Alternatively you can fix one of the dimensions. Set one value and set the other to zero. For example, to export images with a height of 1500 pixels and whatever width is necessary to maintain the original aspect ratio:

```
cxVectorToRasterXRes=0  
cyVextorToRasterYRes=1500
```

The maximum size permitted for either dimension is 4000 pixels.

To set the resolution proportionally

To set the resolution proportionally, set `cxVectorToRasterXRes` to a negative value. A negative value represents a percentage of the original resolution. Set `cyVectorToRasterYRes` to 0 (zero). Negative (percentage) values for `cyVectorToRasterYRes` are ignored.

The following example exports a graphic at 50 percent of its original resolution:

```
cxVectorToRasterXRes=-50  
cyVectorToRasterYRes=0
```

dwFlags

This is a read and write property.

Instructions on how to process the content associated with a paragraph or character style. See [Flags for Defining Styles, on page 89](#) for descriptions of each flag.

NOTE: The value of `Flags` in the template files is used in `dwFlags`.

This property applies to word processing documents only.

FontSizeMap_nSize[1...7]

This is a read and write property.

The font sizes to which the HTML tags `` through `` correspond. If you set `bSupportUserFontSizeMapping` to `FALSE`, this parameter can be left blank.

The values in `FontSizeMap` indicate the range for the HTML tag ``. For example if you specify 6, 9, 12, 18, 21, 24, and 28:

- font size 6 in the source document is mapped to `` in the output HTML
- font size 9 in the source document is mapped to `` in the output HTML
- font size 12 in the source document is mapped to `` in the output HTML
- and so on, up to ``

When the HTML output is viewed, the browser maps `` to a specific font size.

The default font sizes are 8, 10, 12, 14, 18, 24, and 36.

headingCreateType

This is a read and write property.

This property determines how HTML Export subdivides the source document into table of contents entries. This should be set to one of the two options that are enumerated in `KVHeadingCreateOptions` in `kvhtml.h`. The determination of table of contents entries is based on whether the source document contains *heading styles* or whether *text attributes* (bold, underlined, italic, and so on) conform to the criteria defined in `KVHTMLHeadingInfo`. Heading styles are predefined style tags, such as "Heading 1" and "Heading 2" tags in a Microsoft Word document.

This property applies to word processing documents only. The enumerated types are described below.

KVHC_DocHeadingsOnly

This instructs HTML Export to rely exclusively on heading styles defined in the source document. However, if the source document does not contain heading styles, HTML Export generates blocks on its own by using the criteria defined by the parameters in `KVHTMLHeadingInfo`.

KVHC_CreateHeadingsAlways

This instructs HTML Export to use the heading styles in the source document when available, and to also automatically create table of contents entries based on the criteria defined by the parameters in `KVHTMLHeadingInfo`.

NOTE: Note: When the determination of table of contents entries is based on text attributes, source text must meet *all* the criteria defined by the parameters of `KVHTMLHeadingInfo` before it is converted to a heading and included as a table of contents entry.

InputCharSet

This is a read-only property.

The character set of the source document if that information is ascertainable. The character sets that are available are enumerated in `KVCharSet` in `kvcharset.h`.

IcbBlockSize

This is a read and write property.

The maximum size (in bytes) of heading level 1 HTML output files. This number is used as a guideline and can be exceeded to break content at a logical location. This setting is not used when exporting spreadsheets.

IcbMaxMemUsage

This is a read and write property.

The maximum memory allocated dynamically for token buffers during file processing. If this maximum is reached, Export performs a swap-to-disk operation internally, and then reuses the memory blocks. Export maintains an internal minimum memory size.

This property applies to word processing or text documents only.

The default is LONG_MAX. The unit is in bytes.

MarkUpEnd

This is a read and write property.

The markup to be added to the end of a paragraph or character style. See [Map Styles, on page 87](#) for more information on mapping styles.

This property applies to word processing documents only.

MarkUpStart

This is a read and write property.

The markup to be added to the beginning of a paragraph or character style. See [Map Styles, on page 87](#) for more information on mapping styles.

This property applies to word processing documents only.

nCompressionQuality

This is a read and write property.

This property controls the output quality of graphics that support compression quality (for example, JPEG). A value of 0 means default quality (85 compression), 1 is the lowest quality (highest compression and therefore smallest file size), and 100 is the highest quality (no compression and therefore the largest file size).

This property applies to word processing documents only.

nRowsBeforeSplit

This is a read and write property.

The approximate number of spreadsheet rows to be processed before splitting a table. This helps to prevent large spreadsheet tables from occurring in a single document, which can cause speed and processing problems for the browser.

This property applies to spreadsheets only.

nTableBorderWidth

This is a read and write property.

This property sets the width of the table border in pixels.

This property applies to word processing documents only.

NumStyles

The number of developer-defined styles to be used by HTML Export in formatting Cascading Style Sheet (CSS) information passed by the source document.

See [AddStyleMapping](#), on page 279, [GetStyleMapping](#), on page 281, and [RemoveStyleMapping](#), on page 282 for more information.

This property applies to word processing documents only.

OutputCharSet

This is a read and write property.

The character set to use for textual output if the document character set cannot be determined from the document, and the input character set is not specified by `SrcCharSet`. To ensure that the source character set defined here is used, you must set `bForceOutputCharSet` to **TRUE**. The character sets that are available are enumerated in `KVCharSet` in `kvcharset.h`. See [Convert Character Sets](#), on page 83 for more information on mapping character sets.

[Document Readers](#), on page 392 lists the file formats for which character set information can be determined.

OutputLanguageID

This is a read and write property.

The language for the textual output of language-specific data like time and date. Note that `OutputLanguageID` must be in the system locale. If `OutputLanguageID` is invalid or not supplied, the system default is used. Language IDs are enumerated in `KVLanguageID` in `kvtypes.h`.

OutputRasterGraphicType

This is a read and write property.

The output format of rasterized embedded graphics. There are six options enumerated in `KVHTMLGraphicType` in `kvhtml.h`. The default is JPEG.

OutputVectorGraphicType

This is a read and write property.

The output format of vector graphics. The options are enumerated in `KVHTMLGraphicType` in `kvhtml.h`. The default is JPEG.

For more information on displaying vector graphics, see [Display Vector Graphics on UNIX and Linux, on page 91](#).

pHn_bNoMultiSpaces

This is a read and write property.

This is one of the criteria used to determine whether source text should be converted to a heading in the HTML output. If you set `pHn_bNoMultiSpaces` to `TRUE`, the text in the source document must *not* contain two or more contiguous white spaces in order for HTML Export to consider converting it to a heading. The default is `FALSE`.

To determine whether source text should be converted to a heading, HTML Export also considers whether the text meets the criteria defined by the other parameters of `KVHTMLHeadingInfo`.

See [headingCreateType, on page 293](#) for more information on automatic generation of headings.

For this property, *n* can be heading level 1 through 6.

pHn_bNonZeroIndent

This is a read and write property.

This is one of the criteria used to determine whether source text should be converted to a heading in the HTML output. If you set `pHn_bNonZeroIndent` to `TRUE`, the text in the source document must be indented in order for HTML Export to consider converting it to a heading. If you set `pHn_bNonZeroIndent` to `FALSE`, the text must be aligned left. The default is `FALSE`.

To determine whether source text should be converted to a heading, HTML Export also considers whether the text meets the criteria defined by the other parameters of `KVHTMLHeadingInfo`.

See [headingCreateType, on page 293](#) for more information on automatic generation of headings.

For this property, *n* can be heading level 1 through 6.

pHn_bNoTabs

This is a read and write property.

This is one of the criteria used to determine whether source text should be converted to a heading in the HTML output. If you set `pHn_bNoTabs` to `TRUE`, the text in the source document must *not* contain tabs in order for HTML Export to consider converting it to a heading. The default is `FALSE`.

To determine whether source text should be converted to a heading, HTML Export also considers whether the text meets the criteria defined by the other parameters of `KVHTMLHeadingInfo`.

See [headingCreateType, on page 293](#) for more information on automatic generation of headings.

For this property, *n* can be heading level 1 through 6.

pHn_bMustBeBold

This is a read and write property.

This is one of the criteria used to determine whether source text should be converted to a heading in the HTML output. If you set `pHn_bMustBeBold` to `TRUE`, the text in the source document must be bold in order for HTML Export to consider converting it to a heading. The default is `TRUE`.

To determine whether source text should be converted to a heading, HTML Export also considers whether the text meets the criteria defined by the other parameters of `KVHTMLHeadingInfo`.

See [headingCreateType, on page 293](#) for more information on automatic generation of headings.

For this property, *n* can be heading level 1 through 6.

pHn_bMustBeItalic

This is a read and write property.

This is one of the criteria used to determine whether source text should be converted to a heading in the HTML output. If you set `pHn_bMustBeItalic` to **TRUE**, the text in the source document must be italic in order for HTML Export to consider converting it to a heading. The default is **TRUE**.

To determine whether source text should be converted to a heading, HTML Export also considers whether the text meets the criteria defined by the other parameters of `KVHTMLHeadingInfo`.

See [headingCreateType, on page 293](#) for more information on automatic generation of headings.

For this property, *n* can be heading level 1 through 6.

pHn_bMustBeUnderlined

This is a read and write property.

This is one of the criteria used to determine whether source text should be converted to a heading in the HTML output. If you set `pHn_bMustBeUnderlined` to **TRUE**, the text in the source document must be underlined in order for HTML Export to consider converting it to a heading. The default is **TRUE**.

To determine whether source text should be converted to a heading, HTML Export also considers whether the text meets the criteria defined by the other parameters of `KVHTMLHeadingInfo`.

See [headingCreateType, on page 293](#) for more information on automatic generation of headings.

For this property, *n* can be heading level 1 through 6.

pHn_fontSizeMax

This is a read and write property.

This is one of the criteria used to determine whether source text should be converted to a heading in the HTML output. It specifies the maximum font size that text in the source document can be in order for HTML Export to consider converting it to a heading. The default is 20 for heading level 1 and 14 for heading levels 2 to 6.

To determine whether source text should be converted to a heading, HTML Export also considers whether the text meets the criteria defined by the other parameters of `KVHTMLHeadingInfo`.

See [headingCreateType, on page 293](#) for more information on automatic generation of headings.

For this property, *n* can be heading level 1 through 6.

pHn_fontSizeMin

This is a read and write property.

This is one of the criteria used to determine whether source text should be converted to a heading in the HTML output. It specifies the minimum font size that text in the source document can be in order for HTML Export to consider converting it to a heading. The default is 14 for heading level 1 and 14 for heading levels 2 to 6.

To determine whether source text should be converted to a heading, HTML Export also considers whether the text meets the criteria defined by the other parameters of `KVHTMLHeadingInfo`.

See [headingCreateType, on page 293](#) for more information on automatic generation of headings.

For this property, *n* can be heading level 1 through 6.

pHn_maxParaLen

This is a read and write property.

This is one of the criteria used to determine whether source text should be converted to a heading in the HTML output. It specifies the maximum number of characters that text in the source document can contain in order for HTML Export to consider converting it to a heading. The default is 80.

To determine whether source text should be converted to a heading, HTML Export also considers whether the text meets the criteria defined by the other parameters of `KVHTMLHeadingInfo`.

See [headingCreateType, on page 293](#) for more information on automatic generation of headings.

For this property, *n* can be heading level 1 through 6.

This property applies to word processing documents only.

pHn_minParaLen

This is a read and write property.

This is one of the criteria used to determine whether source text should be converted to a heading in the HTML output. It specifies the minimum number of characters that text in the source document can contain in order for HTML Export to consider converting it to a heading. The default is 3.

To determine whether source text should be converted to a heading, HTML Export also considers whether the text meets the criteria defined by the other parameters of `KVHTMLHeadingInfo`.

See [headingCreateType, on page 293](#) for more information on automatic generation of headings.

For this property, *n* can be heading level 1 through 6.

This property applies to word processing documents only.

pHn_mSpaceAfter

This is a read and write property.

This is one of the criteria used to determine whether source text should be converted to a heading in the HTML output. It specifies the amount of space in TWIPS (20th of a point) that must follow a paragraph in the source document in order for HTML Export to consider converting the paragraph to a heading. If -1 is used, the amount of space after the paragraph is not considered in the heading generation.

To determine whether source text should be converted to a heading, HTML Export also considers whether the text meets the criteria defined by the other parameters of `KVHTMLHeadingInfo`.

See [headingCreateType, on page 293](#) for more information on automatic generation of headings.

For this property, n can be heading level 1 through 6.

This property applies to word processing documents only.

pHn_mSpaceBefore

This is a read and write property.

This is one of the criteria used to determine whether source text should be converted to a heading in the HTML output. It specifies the amount of space in TWIPS (20th of a point) that must come before a paragraph in the source document in order for HTML Export to consider converting the paragraph to a heading. If -1 is used, the amount of space before the paragraph is not considered in the heading generation.

To determine whether source text should be converted to a heading, HTML Export also considers whether the text meets the criteria defined by the other parameters of `KVHTMLHeadingInfo`.

For this property, n can be heading level 1 through 6.

This property applies to word processing documents only.

pszAuthor

The contents of the Author property field taken from the source document.

See [GetSummaryInfo, on page 281](#) for more information on all metadata that you can obtain from a document.

pszBaseURL

This is a read and write property.

The base URL that replaces the \$BASE token in the HTML output.

pszComments

The contents of the Comments property field taken from the source document.

See [GetSummaryInfo, on page 281](#) for more information on all metadata that you can obtain from a document.

pszChunkTemplate

This is a read and write property.

If an H1 HTML block is subdivided into separate files as a result of the size limitations specified in `lcbBlockSize`, `pszChunkTemplate` provides a template for creating a table of contents entry for the new file. The chunk number can be made a part of this template by inserting the token `$SPLITBLOCKNUMBER` (for example, "Page `$SPLITBLOCKNUMBER`").

pszDefaultOutputDirectory

This is a read and write property.

The default output directory for auxiliary files that are created. The default is the directory in which your application is running.

pszEndBlock

This is a read and write property.

The markup and HTML Export tokens to be output at the end of each block created as a result of the of `lcbBlockSize` or `bHardPageMakesNewBlock`.

pszFirstH1End

This is a read and write property.

The markup and HTML Export tokens to include in the output at the end of the first H1 HTML block created, that is, the block associated with the first H1 table of contents entry.

pszFirstH1Start

This is a read and write property.

The markup and HTML Export tokens to include in the output at the beginning of the first H1 HTML block created, that is, the block associated with the first H1 table of contents entry.

pszH[2..6]HTML

This is a read and write property.

The markup and HTML Export tokens to include in the output in an HTML block for heading levels 2 through 6.

pszInputFile

This is a read and write property.

The full path and file name of the file that is converted to HTML, or has its metadata or format information extracted. You must set this property for the conversion to proceed.

pszKeyViewDir

This is a read and write property.

The location of the directory where HTML Export is installed. If this property is NULL, required components might not be found.

pszKeywords

This is a read-only property.

The contents of the Keywords property field taken from the source document.

See [GetSummaryInfo](#), on page 281 for more information on all metadata that you can obtain from a document.

pszLastH1End

This is a read and write property.

The markup and HTML Export tokens to include in the output at the end of the last H1 HTML block created, that is, the block associated with the last H1 table of contents entry.

pszLastH1Start

This is a read and write property.

The markup and HTML Export tokens to include in the output at the beginning of the last H1 HTML block created, that is, the block associated with the last H1 table of contents entry.

pszLastSavedby

This is a read-only property.

The contents of the "Last Saved by" field taken from the source document.

See [GetSummaryInfo, on page 281](#) for more information on all metadata that you can obtain from a document.

pszMainBottom

This is a read and write property.

The markup and tokens to include in the output at the end of the main HTML file created during document conversion. This parameter should at least contain the `</html>` tag.

pszMainTop

This is a read and write property.

The markup and tokens to include in the output at the start of the main HTML file created during document conversion. Most of the template files feature `<meta>` tags with tokens that store the input document's metadata. This parameter should at least contain the `<html>` tag. For frames-style HTML output, this parameter must include the `<frame>` tag.

pszMainURL

This is a read and write property.

The URL that replaces the \$MAINURL token in the HTML output.

pszMiddleH1End

This is a read and write property.

The markup and HTML Export tokens to include in the output at the end of those H1 HTML blocks that are neither the first nor the last H1 blocks created, that is, blocks that are associated with all but the first and last H1 table of contents entry.

pszMiddleH1Start

This is a read and write property.

The markup and HTML Export tokens to include in the output at the beginning of those H1 HTML blocks that are neither the first nor the last H1 blocks created, that is, blocks that are associated with all but the first and last H1 table of contents entry.

pszPicPath

This is a read and write property.

The output directory for picture files created during the conversion. The default is the directory in which your application is running.

If specified, this parameter can also be used by the callback functions KVHTMLGetAnchorEx and KVHTMLGetAuxOutputEx.

This property applies to word processing documents only.

pszPicURL

This is a read and write property.

The URL of the picture files created from embedded graphics in the source document.

This property applies to word processing documents only.

pszRevNumber

This is a read-only property.

The contents of the Revision number property field taken from the source document.

See [GetSummaryInfo, on page 281](#) for more information on all metadata that you can obtain from a document.

pszStartBlock

This is a read and write property.

The markup and HTML Export tokens to include in the output at the beginning of each block created as a result of `lcbBlockSize` or `bHardPageMakesNewBlock`.

pszSubject

This is a read-only property.

The contents of the Subject property field taken from the source document.

See [GetSummaryInfo, on page 281](#) for more information on all metadata that you can obtain from a document.

pszTableHTML

This is a read and write property.

Specifies the markup (no tokens) output at the beginning of each table created during the HTML conversion process. If you set this property, table cell color and border information from the document is ignored. This property is used in conjunction with `bTableHTMLForSpreadsheetOnly` to control the look of generated spreadsheets.

For example, to set the tables to be centered, colored, and with big borders, use:

```
pszTableHTML=<table bgcolor="teal" border="13" align="center">
```

pszTemplate

This is a read-only property.

The contents of the Template property field taken from the source document.

See [GetSummaryInfo, on page 281](#) for more information on all metadata that you can obtain from a document.

pszTitle

This is a read-only property.

The contents of the Title property field taken from the source document.

See [GetSummaryInfo, on page 281](#) for more information on all metadata that you can obtain from a document.

pszTOC_H[1..6]

This is a read and write property.

The markup and HTML Export tokens required to process the table of contents entries for heading levels 1 through 6. For example:

```
<a href="$ANCHOR" target="right">$TOCTE</a>
```

pszTOCH[1..6]End

This is a read and write property.

The markup and HTML Export tokens to include in the output at the end of a table of contents block for heading levels 1 through 6 TOC entries. An example of pszTOCH[1..6]End is `</o1>`.

pszTOCH[1..6]LeafNode

This is a read and write property.

The markup that replaces pszTOC_H[1..6] entries for leaf nodes in the table of contents. A leaf node is a node that has no children.

pszTOCH[1..6]Start

This is a read and write property.

The markup and HTML Export tokens to include in the output at the beginning of a table of contents block for heading levels 1 through 6 TOC entries. An example of `pszTOC_H[1..6]Start` would be `<ol type=I>`.

pszUserSummary

This is a read and write property.

The markup and tokens that are generated when the tokens `$USERSUMMARY`, `$SUMMARY`, or `$SUMMARYNN` are used. For example:

```
"<meta title="$SUMMARY01" author="$SUMMARY03"/>".
```

pszXFile

This is a read and write property.

The markup and HTML Export tokens that are generated and placed in an extra HTML file. This file holds content from the source document (for example, a separate file containing `$TOC` that can be displayed within an HTML frame). To process this file, use the `$XANCHOR` token. See [Export Tokens, on page 451](#) for more information on `$XANCHOR`.

For example, if the extra file is to contain the table of contents in frame-based HTML, set `pszXFile` to `$TOC` and place the following HTML markup in the `pszMainTop` element:

```
<frame src="$XANCHOR" name="left" scrolling="auto" target="right">.
```

pszXStartBlock

This is a read and write property.

The markup and tokens to include in the output at the beginning of each HTML block generated by the `$XANCHOR` token. If either this parameter or `pszXEndBlock` is defined, both `pszStartBlock` and `pszEndBlock` are ignored. See [Export Tokens, on page 451](#) for more information on `$XANCHOR`.

pszXEndBlock

This is a read and write property.

The markup and tokens to include in the output at the end of each HTML block generated by the `$XANCHOR` token. If either this parameter or `pszXStartBlock` is defined, both `pszStartBlock` and `pszEndBlock` are ignored. See [Export Tokens, on page 451](#) for more information on `$XANCHOR`.

SATableBorder

This is a read and write property.

This property specifies whether table borders in the HTML output are based on the setting in the source document, are always on, or are always off. The options are enumerated in `ENSATableBorder` of `kvtypes.h`.

This property applies to word processing documents only.

SrcCharSet

This is a read and write property.

This property specifies the source character set if the reader for the document type cannot determine the character set. To ensure that the source character set defined here is used, you might have to set `bForceSrcCharSet` to `TRUE`. The character sets that are available are enumerated in `KVCharSet` in `kvcharset.h`. See [Convert Character Sets, on page 83](#) for more information on character set mapping.

The section [Document Readers, on page 392](#) lists the file formats for which character set information can be determined.

StyleSheetType

This is a read and write property.

One of the three enumerated options for processing style sheet information.

- To disable style sheet formatting, set `StyleSheetType` to `STYLESHEET_DISABLED`.
- To enable Cascading Style Sheet (CSS) formatting and output the generated formatting data within the HTML output stream, set `StyleSheetType` to `CSS_INLINE`.
- To enable CSS formatting and output the generated formatting data in an external CSS file referenced in the HTML output as a tag, set `StyleSheetType` to `CSS_TOFILE`.

Refer to [KVHTMLStyleSheetType, on page 264](#) for more information on these enumerated options.

StyleName

This is a read and write property.

The name of the word processing style (for example, "Heading 1") to which style mapping is applied. Style names are case sensitive. See [Map Styles, on page 87](#) for more information on mapping styles.

This property applies to word processing documents only.

Timeout

This is a read and write property.

The number of seconds that HTML Export should allow for converting a source document before killing the process. This property guards against hung processes. Setting this property to **-1** deprives HTML Export of a timeout guideline, that is, no processes are terminated. This property applies only to the out-of-process COM object.

Part 5: Appendixes

This section lists supported formats, supported character sets and redistributed files, and provides information on format detection.

- [Supported Formats](#)
- [Document Readers](#)
- [Character Sets](#)
- [Extract and Format Lotus Notes Subfiles](#)
- [Export Tokens](#)
- [File Format Detection](#)
- [Files Required for Redistribution](#)
- [Password Protected Files](#)
- [Microsoft Rights Management Service Protected Files, on page 476](#)

Appendix A: Supported Formats

This section lists the file formats that KeyView can detect.

- [Key to Supported Formats Table](#)312
- [Supported Formats](#)314

Key to Supported Formats Table

The supported formats table includes the following information:

Column	Description
Format Name	The format name that is returned by KeyView format detection. <ul style="list-style-type: none">• In the C API, these values are defined in the <code>ENdocFmt</code> enumeration in <code>adDocFmt.h</code>.• In the .NET API these values are defined in the <code>Autonomy.API.Export.DocFormat</code> enumeration.• In the Java API these values are defined in the <code>com.verity.api.DocFormat</code> enumeration.
Number	The format number that is returned by KeyView format detection. This is the value associated with the Format Name in the relevant enumeration.
Category	This value is used in the KeyView configuration file <code>formats.ini</code> to specify the reader to use to filter, export, or view the format. Several formats might have the same category value.
Description	A short description of the file format.
MIME Type	The MIME type (if any).
Extension	A list of common file extensions for the file format. NOTE: This is not a complete list of file extensions. KeyView does not distinguish between file types based on their extension. Instead, it detects the file format based on the file content. This is more reliable because content cannot always be predicted from the file extension, and because some file extensions are associated with multiple formats.
File Class	The KeyView file class. <ul style="list-style-type: none">• In the C API, these values are defined in the <code>ENdocClass</code> enumeration in <code>adinfo.h</code>.

	<ul style="list-style-type: none">• In the .NET API these values are defined in the <code>Autonomy.API.Export.DocClass</code> enumeration.• In the Java API these values are defined in the <code>com.verity.api.DocClass</code> enumeration.
--	--

Supported Formats

Format Name	Number	Category	Description	MIME Type	Extension	File Class	Readers
Reserved_Fmt	-1	-1				AutoDetNoFormat	
Unknown_Fmt	0	0				AutoDetNoFormat	
AES_Multiplus_Comm_Fmt	1	1	Multiplus (AES)		PTF	adWORDPROCESSOR	
ASCII_Text_Fmt	2	2	Plain Text file	text/plain	TXT	adWORDPROCESSOR	afsr
MSDOS_Batch_File_Fmt	3	2	MS-DOS Batch File	application/x-bat	BAT	adEXECUTABLE	afsr
Applix_Alis_Fmt	4	3	Applix Asterix		AX	adWORDPROCESSOR	axsr
BMP_Fmt	5	4	Windows Bitmap Image (BMP)	image/bmp	BMP	adRASTERIMAGE	bmspr , kpbmprdr
CT_DEF_Fmt	6	5	Convergent Technologies DEF Comm. Format			adWORDPROCESSOR	cdsr
Corel_Draw_Fmt	7	6	CorelDRAW (up to version 13/X3)	application/coreldraw	CDR	adVECTORGRAPHIC	kpcdrdr
CGM_ClearText_Fmt	8	8	Computer Graphics Metafile (CGM)		CGM	adVECTORGRAPHIC	kpcgmrdr
CGM_Binary_Fmt	9	8	Computer Graphics Metafile (CGM)	image/cgm	CGM	adVECTORGRAPHIC	kpcgmrdr
CGM_Character_Fmt	10	8	Computer Graphics Metafile (CGM)		CGM	adVECTORGRAPHIC	kpcgmrdr
Word_Connection_Fmt	11	9	Word Connection		CN	adWORDPROCESSOR	stringssr
COMET_TOP_Word_Fmt	12	10	Nixdorf COMET TOP Financial Accounting software			adWORDPROCESSOR	
CEOWrite_Fmt	13	11	CEOWrite		CW	adWORDPROCESSOR	stringssr
DSA101_Fmt	14	12	DSA101 (Honeywell Bull)			adWORDPROCESSOR	stringssr
DCA_RFT_Fmt	15	13	IBM DCA-RFT (Revisable Form)	application/dca-rft	RFT, DC	adWORDPROCESSOR	dcasr
CDA_DDIF_Fmt	16	14	CDA/ DDIF		DDIF	adWORDPROCESSOR	

Format Name	Number	Category	Description	MIME Type	Extension	File Class	Readers
DG_CDS_Fmt	17	16	DG Common Data Stream (CDS)		CDS	adWORDPROCESSOR	stringssr
Micrografx_Draw_Fmt	18	18	Windows Draw (Micrografx)	image/x-mgx-dsf	DRW	adVECTORGRAPHIC	
Data_Point_VistaWord_Fmt	19	19	Vistaword		DV	adWORDPROCESSOR	stringssr
DECdx_Fmt	20	20	DEC WPS Plus DX format	application/dec-dx	DX	adWORDPROCESSOR	
Enable_WP_Fmt	21	21	Enable Word Processing	application/ewp	WPF	adWORDPROCESSOR	stringssr
EPSF_Fmt	22	22	Encapsulated PostScript	application/postscript	EPS	adRASTERIMAGE, adVECTORGRAPHIC	kpepsrdr
Preview_EPSF_Fmt	23	22	Encapsulated PostScript	application/postscript		adRASTERIMAGE, adVECTORGRAPHIC	kpepsrdr
MS_Executable_Fmt	24	23	MSDOS/Windows executable	application/x-msdownload	EXE	adEXECUTABLE	exesr
G31D_Fmt	25	24	CCITT G3 1D			adRASTERIMAGE	
GIF_87a_Fmt	26	25	Graphics Interchange Format (GIF87a)	image/gif	GIF	adRASTERIMAGE	gifsr , kpgifdr
GIF_89a_Fmt	27	25	Graphics Interchange Format (GIF89a)	image/gif	GIF	adRASTERIMAGE	gifsr , kpgifdr
HP_Word_PC_Fmt	28	26	HP Word PC		HW	adWORDPROCESSOR	stringssr
IBM_1403_LinePrinter_Fmt	29	27	IBM 1403 Line Printer		I4	adWORDPROCESSOR	
IBM_DCF_Script_Fmt	30	28	DCF Script		IC	adWORDPROCESSOR	stringssr
IBM_DCA_FFT_Fmt	31	29	DCA-FFT (IBM Final Form)	text/x-ibm-fft	IF, FFT	adWORDPROCESSOR	
Interleaf_Fmt	32	30	Interleaf			adWORDPROCESSOR	
GEM_Image_Fmt	33	31	GEM Bit Image		IMG	adRASTERIMAGE	
IBM_Display_Write_Fmt	34	32	IBM DisplayWrite	application/x-displaywrite	IP	adWORDPROCESSOR	dw4sr
Sun_Raster_Fmt	35	33	Sun Raster image	image/x-cmu-raster	RAS, RS, SUN	adRASTERIMAGE	kpsunrdr
Ami_Pro_Fmt	36	35	Lotus Ami Pro	application/x-lotus-amipro	SAM	adWORDPROCESSOR	lasr
Ami_Pro_StyleSheet_Fmt	37	35	Lotus Ami Pro Style Sheet			adWORDPROCESSOR	lasr
MORE_Fmt	38	36	MORE Database MAC			adOUTLINE	
Lyrix_Fmt	39	37	Lyrix Word Processing			adWORDPROCESSOR	stringssr

Format Name	Number	Category	Description	MIME Type	Extension	File Class	Readers
MASS_11_Fmt	40	38	MASS-11	application/x-mass-11	M1	adWORDPROCESSOR	stringssr
MacPaint_Fmt	41	39	MacPaint	image/x-macpaint	MAC, PIC, PNTG	adRASTERIMAGE	kpmacrdr
MS_Word_Mac_Fmt	42	40	Microsoft Word for Macintosh (up to version 3)	application/msword	DOC	adWORDPROCESSOR	mbsr
SmartWare_II_Comm_Fmt	43	41	SmartWare II			adCOMMUNICATION	
MS_Word_Win_Fmt	44	42	Microsoft Word for Windows (up to version 6)	application/msword	DOC, WPS	adWORDPROCESSOR	misr
Multimate_Fmt	45	43	MultiMate	application/x-multimate	MM	adWORDPROCESSOR	stringssr
Multimate_Fnote_Fmt	46	43	MultiMate Footnote File	application/x-multimate-note	MMFN	adWORDPROCESSOR	stringssr
Multimate_Adv_Fmt	47	43	MultiMate Advantage			adWORDPROCESSOR	stringssr
Multimate_Adv_Fnote_Fmt	48	43	MultiMate Advantage Footnote File			adWORDPROCESSOR	stringssr
Multimate_Adv_II_Fmt	49	43	MultiMate Advantage II			adWORDPROCESSOR	stringssr
Multimate_Adv_II_Fnote_Fmt	50	43	MultiMate Advantage II Footnote File		FBX, FNX	adWORDPROCESSOR	stringssr
Multiplan_PC_Fmt	51	44	Microsoft Multiplan (PC)	application/x-ms-multiplan		adSPREADSHEET	
Multiplan_Mac_Fmt	52	44	Microsoft Multiplan (Mac)	application/x-ms-multiplan		adSPREADSHEET	
MS_RTF_Fmt	53	45	Rich Text Format (RTF)	application/rtf	RTF	adWORDPROCESSOR	rtfsr
MS_Word_PC_Fmt	54	46	Microsoft Word for PC (up to version 6)	application/x-ms-wordpc	MW	adWORDPROCESSOR	mwsr
MS_Word_PC_StyleSheet_Fmt	55	46	Microsoft Word for PC (up to version 6) Style Sheet			adWORDPROCESSOR	mwsr
MS_Word_PC_Glossary_Fmt	56	46	Microsoft Word for PC (up to version 6) Glossary			adWORDPROCESSOR	mwsr
MS_Word_PC_Driver_Fmt	57	46	Microsoft Word for PC (up to version 6) Driver			adWORDPROCESSOR	mwsr
MS_Word_PC_Misc_Fmt	58	46	Microsoft Word for PC (up to version 6) Miscellaneous File			adWORDPROCESSOR	mwsr
NBI_Async_Archive_Fmt	59	47	NBI Async Archive Format			adWORDPROCESSOR	
Navy_DIF_Fmt	60	48	Navy DIF (document interchange format)	application/x-navy	ND	adWORDPROCESSOR	stringssr

Format Name	Number	Category	Description	MIME Type	Extension	File Class	Readers
NBI_Net_Archive_Fmt	61	49	NBI OASys Net Archive Format		NN	adWORDPROCESSOR	nnsr
NIOS_TOP_Fmt	62	50	NIOS TOP			adWORDPROCESSOR	
FileMaker_Mac_Fmt	63	51	Filemaker MAC		FP5, FP7	adDATABASE	
ODA_Q1_11_Fmt	64	52	ODA / ODIF Q1 11		OD	adWORDPROCESSOR	stringssr
ODA_Q1_12_Fmt	65	52	ODA / ODIF Q1 12		OD	adWORDPROCESSOR	stringssr
OLIDIF_Fmt	66	53	OLIDIF (Olivetti)			adWORDPROCESSOR	
Office_Writer_Fmt	67	55	Office Writer		OW	adWORDPROCESSOR	stringssr
PC_Paintbrush_Fmt	68	56	PC Paintbrush Graphics (PCX)	image/vnd.zbrush.pcx	PCX	adRASTERIMAGE	kppcxrdr
CPT_Comm_Fmt	69	57	CPT Corporation word processor		PF	adWORDPROCESSOR	stringssr
Lotus_PIC_Fmt	70	58	Lotus PIC	image/x-pict	PIC	adVECTORGRAPHIC	kppicrdr
Mac_PICT_Fmt	71	59	Macintosh Raster / QuickDraw Picture	image/x-pict	PCT	adRASTERIMAGE, adVECTORGRAPHIC	kppctrdr
Philips_Script_Word_Fmt	72	60	Philips Script			adWORDPROCESSOR	
PostScript_Fmt	73	61	PostScript	application/postscript	PS	adVECTORGRAPHIC	
PRIMEWORD_Fmt	74	62	PRIMEWORD			adWORDPROCESSOR	pwsr
Quadratron_Q_One_v1_Fmt	75	63	Q-One V1.93J		Q1, QX	adWORDPROCESSOR	stringssr
Quadratron_Q_One_v2_Fmt	76	64	Q-One V2.0		Q1, QX	adWORDPROCESSOR	stringssr
SAMNA_Word_IV_Fmt	77	65	SAMNA Word		SAM	adWORDPROCESSOR	stringssr
Ami_Pro_Draw_Fmt	78	66	Lotus Ami Pro Draw		SDW	adVECTORGRAPHIC, adRASTERIMAGE	kpsdwrdr
SYLK_Spreadsheet_Fmt	79	67	SYmbolic LinK (SYLK) format		SLK	adSPREADSHEET	
SmartWare_II_WP_Fmt	80	68	Informix SmartWare II word processor		DOC, SMT	adWORDPROCESSOR	swsr
Symphony_Fmt	81	69	Lotus Symphony spreadsheet	application/vnd.symphony	WR1	adSPREADSHEET	
Targa_Fmt	82	70	Truevision Targa image	image/x-tga	TGA	adRASTERIMAGE	kpTGArd
TIFF_Fmt	83	71	Tagged Image File Format	image/tiff	TIF, TIFF	adRASTERIMAGE,	kptifdr, tifsr

Format Name	Number	Category	Description	MIME Type	Extension	File Class	Readers
			(TIFF)			adFAXFORMAT	
Targon_Word_Fmt	84	72	Targon Word		TW	adWORDPROCESSOR	stringssr
Uniplex_Ucalc_Fmt	85	73	Uniplex Ucalc		SS	adSPREADSHEET	
Uniplex_WP_Fmt	86	74	Uniplex word processor		UP	adWORDPROCESSOR	stringssr
MS_Word_UNIX_Fmt	87	75	Microsoft Word UNIX	application/msword		adWORDPROCESSOR	
WANG_PC_Fmt	88	76	Wang IWP for PC	application/x-wang-iwp	DOC	adWORDPROCESSOR	
WordERA_Fmt	89	77	WordERA		DC, GL, FR	adWORDPROCESSOR	stringssr
WANG_WPS_Comm_Fmt	90	78	WANG WPS		WF	adWORDPROCESSOR	stringssr
WordPerfect_Mac_Fmt	91	79	WordPerfect MAC	application/x-corel-wordperfect		adWORDPROCESSOR	wpmsr
WordPerfect_Fmt	92	86	WordPerfect version 4	application/x-corel-wordperfect	WP, WP4	adWORDPROCESSOR	stringssr
WordPerfect_VAX_Fmt	93	139	WordPerfect VAX	application/x-corel-wordperfect		adWORDPROCESSOR	
WordPerfect_Macro_Fmt	94	139	WordPerfect Macro	application/vnd.wordperfect	MRS	adWORDPROCESSOR	
WordPerfect_Dictionary_Fmt	95	139	WordPerfect Spelling Dictionary	application/vnd.wordperfect	SPW	adWORDPROCESSOR	
WordPerfect_Thesaurus_Fmt	96	139	WordPerfect Thesaurus	application/vnd.wordperfect		adWORDPROCESSOR	
WordPerfect_Resource_Fmt	97	139	WordPerfect Resource File	application/vnd.wordperfect	WWK, PRS	adWORDPROCESSOR	
WordPerfect_Driver_Fmt	98	139	WordPerfect Driver	application/vnd.wordperfect	IRS, VRS	adWORDPROCESSOR	
WordPerfect_Cfg_Fmt	99	139	WordPerfect Configuration File	application/vnd.wordperfect	PFX	adWORDPROCESSOR	
WordPerfect_Hyphenation_Fmt	100	139	WordPerfect Hyphenation Dictionary	application/vnd.wordperfect	HYC	adWORDPROCESSOR	
WordPerfect_Misc_Fmt	101	139	WordPerfect Miscellaneous File	application/vnd.wordperfect		adWORDPROCESSOR	
WordMARC_Fmt	102	82	WordMARC Composer	video/x-ms-wm	WM, PW	adWORDPROCESSOR	stringssr
Windows_Metatile_Fmt	103	83	Windows Metatile	image/wmf	WMF	adVECTORGRAPHIC, adRASTERIMAGE	kpwmfrdr
Windows_Metatile_NoHdr_Fmt	104	83	Windows Metatile (no header)	image/wmf	WMF	adVECTORGRAPHIC	kpwmfrdr
SmartWare_II_DB_Fmt	105	84	Informix SmartWare II database	database/x-smartdata		adDATABASE	

Format Name	Number	Category	Description	MIME Type	Extension	File Class	Readers
WordPerfect_Graphics_Fmt	106	195	WordPerfect Graphics (version 2 and higher)	application/vnd.wordperfect	WPG, QPG	adRASTERIMAGE, adVECTORGRAPHIC	kpwg2rdr, kwpwgrdr
WordStar_Fmt	107	87	WordStar	application/vnd.wordstar	WS, WSD	adWORDPROCESSOR	stringssr
WANG_WITA_Fmt	108	88	WANG WITA		WT	adWORDPROCESSOR	stringssr
Xerox_860_Comm_Fmt	109	89	Xerox 860			adWORDPROCESSOR	stringssr
Xerox_Writer_Fmt	110	91	Xerox Writer			adWORDPROCESSOR	stringssr
DIF_SpreadSheet_Fmt	111	92	Data Interchange Format (DIF)	application/dif+xml	DIF	adSPREADSHEET	difsr
Enable_Spreadsheet_Fmt	112	93	Enable Spreadsheet	application/vnd.epson.ssf	SSF	adSPREADSHEET	
SuperCalc_Fmt	113	94	Sorcim SuperCalc spreadsheet	application/x-supercalc5	CAL	adSPREADSHEET	
UltraCalc_Fmt	114	95	UltraCalc spreadsheet			adSPREADSHEET	
SmartWare_II_SS_Fmt	115	96	Informix SmartWare II spreadsheet	application/x-smartware		adSPREADSHEET	
SOF_Encapsulation_Fmt	116	97	Serialized Object Format (SOF)	application/java-serialized-object	SOF	adENCAPSULATION	
PowerPoint_Win_Fmt	117	98	Microsoft PowerPoint PC (up to version 4)	application/x-ms-powerpoint	PPT	adPRESENTATION	kpp40rdr
PowerPoint_Mac_Fmt	118	99	Microsoft PowerPoint MAC (up to version 4)	application/x-ms-powerpoint	PPT	adPRESENTATION	olesr
PowerPoint_95_Fmt	119	212	Microsoft PowerPoint 95	application/x-ms-powerpoint	PPT	adPRESENTATION	kpp95rdr
PowerPoint_97_Fmt	120	272	Microsoft PowerPoint 97	application/x-ms-powerpoint	PPT	adPRESENTATION	kpp97rdr
PageMaker_Mac_Fmt	121	100	PageMaker for Macintosh			adDESKTOPPUBLSH	
PageMaker_Win_Fmt	122	101	PageMaker for Windows			adDESKTOPPUBLSH	
MS_Works_Mac_WP_Fmt	123	103	Microsoft Works Word Processor for MAC	application/x-msworks	MWK	adWORDPROCESSOR	stringssr
MS_Works_Mac_DB_Fmt	124	104	Microsoft Works Database for MAC	application/x-msworks		adDATABASE	
MS_Works_Mac_SS_Fmt	125	105	Microsoft Works Spreadsheet for MAC	application/x-msworks		adSPREADSHEET	mwssr
MS_Works_Mac_Comm_Fmt	126	106	Microsoft Works Communication for MAC	application/x-msworks		adCOMMUNICATION	
MS_Works_DOS_WP_Fmt	127	107	Microsoft Works Word Processor for DOS	application/x-msworks	WPS	adWORDPROCESSOR	stringssr

Format Name	Number	Category	Description	MIME Type	Extension	File Class	Readers
MS_Works_DOS_DB_Fmt	128	108	Microsoft Works Database for DOS	application/x-msworks	WDB	adDATABASE	
MS_Works_DOS_SS_Fmt	129	109	Microsoft Works Spreadsheet for DOS	application/x-msworks		adSPREADSHEET	mwssr
MS_Works_Win_WP_Fmt	130	227	Microsoft Works Word Processor for Windows (up to 2000)	application/x-msworks	WPS, W40	adWORDPROCESSOR	msw6sr , mswsr
MS_Works_Win_DB_Fmt	131	231	Microsoft Works Database for Windows	application/x-msworks		adDATABASE	
MS_Works_Win_SS_Fmt	132	228	Microsoft Works Spreadsheet for Windows	application/x-msworks	WKS, S30, S40	adSPREADSHEET	mwssr
PC_Library_Fmt	133	111	DOS/Windows Object Library	application/x-archive	LIB, A	adLIBRARY	
MacWrite_Fmt	134	112	MacWrite	application/macwriteii		adWORDPROCESSOR	stringssr
MacWrite_II_Fmt	135	113	MacWrite II	application/macwriteii		adWORDPROCESSOR	stringssr
Freehand_Fmt	136	114	Freehand MAC	image/x-freehand		adVECTORGRAPHIC	
Disk_Doubler_Fmt	137	115	Disk Doubler			adENCAPSULATION	
HP_GL_Fmt	138	116	HP Graphics Language	vector/x-hpgl	HPGL, HPG	adVECTORGRAPHIC	
FrameMaker_Fmt	139	136	FrameMaker	application/vnd.frameMaker	FM, FRM	adDESKTOPPUBLSH	
FrameMaker_Book_Fmt	140	136	FrameMaker Book	application/vnd.frameMaker	BOOK	adDESKTOPPUBLSH	
Maker_Markup_Language_Fmt	141	174	Maker Markup Language	application/vnd.mif		adDESKTOPPUBLSH	
Maker_Interchange_Fmt	142	117	Adobe FrameMaker Interchange Format (MIF)	application/x-mif	MIF	adWORDPROCESSOR	mifsr
JPEG_File_Interchange_Fmt	143	118	JPEG Interchange Format	image/jpeg	JPG, JPEG	adRASTERIMAGE	jpgsr , kjpggrdr
Reflex_Fmt	144	119	Borland Reflex database	database/reflex		adDATABASE	
Framework_Fmt	145	276	Framework office suite			adMIXED	
Framework_II_Fmt	146	120	Framework II office suite		FW3	adMIXED	
Paradox_Fmt	147	121	Borland Paradox database	application/paradox	DB	adDATABASE	
MS_Windows_Write_Fmt	148	123	Microsoft Windows Write	application/x-ms-write	WRI	adWORDPROCESSOR	mwsr
Quattro_Pro_DOS_Fmt	149	124	Corel Quattro Pro for DOS	application/x-quattropro	WQ1	adSPREADSHEET	
Quattro_Pro_Win_Fmt	150	184	Corel Quattro Pro for	application/x-quattro-win	WB1, WB2, WB3	adSPREADSHEET	qpsr

Format Name	Number	Category	Description	MIME Type	Extension	File Class	Readers
			Windows				
Persuasion_Fmt	151	126	Adobe Persuasion			adPRESENTATION	
Windows_Icon_Fmt	152	128	Windows Icon Format	image/vnd.microsoft.icon	ICO	adRASTERIMAGE	kpicordr
Windows_Cursor_Fmt	153	133	Windows Cursor	image/x-win-bitmap	CUR	adRASTERIMAGE	
MS_Project_Activity_Fmt	154	129	Microsoft Project (up to version 3) activity file			adSCHEDULE	
MS_Project_Resource_Fmt	155	129	Microsoft Project (up to version 3) resource file			adSCHEDULE	
MS_Project_Calc_Fmt	156	129	Microsoft Project (up to version 3) calc file			adSCHEDULE	
PKZIP_Fmt	157	132	ZIP Archive	application/zip	ZIP, ZIPX	adENCAPSULATION, adEXECUTABLE	unzip
Quark_Xpress_Fmt	158	134	Quark Xpress MAC			adDESKTOPPUBLISH	
ARC_PAK_Archive_Fmt	159	135	PAK/ARC Archive		ARC, PAK	adENCAPSULATION	
MS_Publisher_Fmt	160	137	Microsoft Publisher (up to version 3)	application/x-mspublisher	PUB	adDESKTOPPUBLISH	mspusr
PlanPerfect_Fmt	161	138	PlanPerfect			adSCHEDULE	
WordPerfect_Auxiliary_Fmt	162	139	Corel WordPerfect auxiliary file		WPW	adMISC, adENCAPSULATION	
MS_WAVE_Audio_Fmt	163	141	Microsoft Wave audio	audio/wav	WAV	adSOUND	MCI , riffsr
MIDI_Audio_Fmt	164	142	MIDI audio	audio/mid	MID, MIDI	adSOUND	MCI
AutoCAD_DXF_Binary_Fmt	165	143	Autodesk AutoCAD DXF binary format	image/x-dxf	DXF	adVECTORGRAPHIC	kpDXFrdr , kpODArdr
AutoCAD_DXF_Text_Fmt	166	143	Autodesk AutoCAD DXF text format	image/x-dxf	DXF	adVECTORGRAPHIC	kpDXFrdr , kpODArdr
dBase_Fmt	167	144	dBase Database III+/IV	application/x-dbf	DBF, VCX	adDATABASE	dbfsr
OS_2_PM_Metatile_Fmt	168	145	OS/2 PM Metatile		MET	adVECTORGRAPHIC	
Lasergraphics_Language_Fmt	169	146	Lasergraphics Language			adVECTORGRAPHIC	
AutoShade_Rendering_Fmt	170	147	AutoShade Rendering	application/x-autoshade		adVECTORGRAPHIC	
GEM_VDI_Fmt	171	148	GEM VDI Metatile image		GEM, GDI	adVECTORGRAPHIC	
Windows_Help_Fmt	172	149	Windows Help File	application/winhelp	HLP	adMISC	

Format Name	Number	Category	Description	MIME Type	Extension	File Class	Readers
Volkswriter_Fmt	173	150	Volkswriter word processor		VW4	adWORDPROCESSOR	stringssr
Ability_WP_Fmt	174	151	Ability Word Processor			adWORDPROCESSOR	
Ability_DB_Fmt	175	151	Ability Database			adDATABASE	
Ability_SS_Fmt	176	151	Ability Spreadsheet			adSPREADSHEET	
Ability_Comm_Fmt	177	151	Ability Presentation			adCOMMUNICATION	
Ability_Image_Fmt	178	151	Ability Image			adRASTERIMAGE	
XyWrite_Fmt	179	152	XYWrite / Nota Bene		XY4	adWORDPROCESSOR	xywsr
CSV_Fmt	180	153	CSV (Comma Separated Values)	text/csv	CSV	adSPREADSHEET	csvsr
IBM_Writing_Assistant_Fmt	181	154	IBM Writing Assistant		IWA	adWORDPROCESSOR	stringssr
WordStar_2000_Fmt	182	155	WordStar 2000		WS2	adWORDPROCESSOR	stringssr
HP_PCL_Fmt	183	157	HP Printer Control Language	application/pcl	PCL	adVECTORGRAPHIC	
UNIX_Exe_PreSysV_VAX_Fmt	184	158	UNIX executable (PDP-11/pre-System V VAX)	application/octet-stream		adEXECUTABLE	
UNIX_Exe_Basic_16_Fmt	185	158	UNIX executable (Basic-16)	application/octet-stream		adEXECUTABLE	
UNIX_Exe_x86_Fmt	186	158	UNIX executable (x86)	application/octet-stream		adEXECUTABLE	
UNIX_Exe_iAPX_286_Fmt	187	158	UNIX executable (iAPX 286)	application/octet-stream		adEXECUTABLE	
UNIX_Exe_MC68k_Fmt	188	158	UNIX executable (MC680x0)	application/octet-stream		adEXECUTABLE	
UNIX_Exe_3B20_Fmt	189	158	UNIX executable (3B20)	application/octet-stream		adEXECUTABLE	
UNIX_Exe_WE32000_Fmt	190	158	UNIX executable (WE32000)	application/octet-stream		adEXECUTABLE	
UNIX_Exe_VAX_Fmt	191	158	UNIX executable (VAX)	application/octet-stream		adEXECUTABLE	
UNIX_Exe_Bell_5_Fmt	192	158	UNIX executable (Bell 5.0)	application/octet-stream		adEXECUTABLE	
UNIX_Obj_VAX_Demand_Fmt	193	159	UNIX object module (VAX Demand)			adOBJECTMODULE	
UNIX_Obj_MS8086_Fmt	194	159	UNIX object module (old MS 8086)			adOBJECTMODULE	

Format Name	Number	Category	Description	MIME Type	Extension	File Class	Readers
UNIX_Obj_Z8000_Fmt	195	159	UNIX object module (Z8000)			adOBJECTMODULE	
AU_Audio_Fmt	196	161	NeXT/Sun Audio Data	audio/basic	AU, SND	adSOUND	MCI
NeWS_Font_Fmt	197	162	NeWS bitmap font			adFONT	
cpio_Archive_CRCChr_Fmt	198	163	cpio archive (CRC Header)	application/x-cpio	CPIO	adENCAPSULATION	
cpio_Archive_CHRhdr_Fmt	199	163	cpio archive (CHR Header)	application/x-cpio	CPIO	adENCAPSULATION	
PEX_Binary_Archive_Fmt	200	164	SUN PEX Binary Archive			adENCAPSULATION	
Sun_vfont_Fmt	201	165	SUN vfont Definition			adFONT	
Curses_Screen_Fmt	202	166	Curses Screen Image			adRASTERIMAGE	
UUEncoded_Fmt	203	167	UU-encoded text	text/x-uuencode	UUE	adENCAPSULATION	uudsr
WriteNow_Fmt	204	168	WriteNow MAC			adWORDPROCESSOR	stringssr
PC_Obj_Fmt	205	169	DOS/Windows Object Module	application/octet-stream	OBJ	adOBJECTMODULE	
Windows_Group_Fmt	206	170	Windows Group			adMISC	
TrueType_Font_Fmt	207	171	TrueType Font	application/x-font-ttf	TTF	adFONT	
Windows_PIF_Fmt	208	172	Program Information File (PIF)	application/octet-stream	PIF	adMISC	
MS_COM_Executable_Fmt	209	173	PC (.COM)	application/octet-stream	COM	adEXECUTABLE	
Stuftit_Fmt	210	175	Stuftit (MAC)	application/x-stuftit	HQX	adENCAPSULATION	
PeachCalc_Fmt	211	176	PeachCalc		CAL	adSPREADSHEET	
Wang_GDL_Fmt	212	177	WANG Office GDL Header			adENCAPSULATION	
Q_A_DOS_Fmt	213	179	Symantec Q&A for DOS	application/x-qa-write		adWORDPROCESSOR	stringssr
Q_A_Win_Fmt	214	180	Symantec Q&A for Windows	application/x-qa-write	JW	adWORDPROCESSOR	stringssr
WPS_PLUS_Fmt	215	181	WPS-PLUS	application/vnd.ms-wpl	WPL	adWORDPROCESSOR	stringssr
DCX_Fmt	216	182	DCX FAX Format(PCX images)	image/dcx	DCX	adFAXFORMAT	kpdcxrd
OLE_Fmt	217	183	OLE Compound Document		OLE	adENCAPSULATION	olesr
EBCDIC_Fmt	218	186	EBCDIC Text	application/ebcdic		adWORDPROCESSOR	

Format Name	Number	Category	Description	MIME Type	Extension	File Class	Readers
DCS_Fmt	219	187	DCS			adWORDPROCESSOR	
UNIX_SHAR_Fmt	220	190	SHAR shell archive format	application/x-shar	SHAR	adENCAPSULATION	
Lotus_Notes_BitMap_Fmt	221	191	Lotus Notes Bitmap			adRASTERIMAGE	
Lotus_Notes_CDF_Fmt	222	193	Lotus Notes CDF	application/cdf	CDF	adWORDPROCESSOR	stringssr
Compress_Fmt	223	192	UNIX Compress archive	application/x-compress	Z	adENCAPSULATION	kvzee , kvzeesr
GZ_Compress_Fmt	224	198	GZ Compress archive	application/gzip	GZ	adENCAPSULATION	kvgz , kvgzsr
TAR_Fmt	225	194	TAR (tape archive)	application/tar	TAR	adENCAPSULATION	tarsr
ODIF_FOD26_Fmt	226	196	Open Document Architecture (ODA / ODIF) FOD26	application/oda	F26	adWORDPROCESSOR	
ODIF_FOD36_Fmt	227	196	Open Document Architecture (ODA / ODIF) FOD36	application/oda	F36	adWORDPROCESSOR	
ALIS_Fmt	228	197	ALIS			adWORDPROCESSOR	
Envoy_Fmt	229	199	WordPerfect Envoy	application/envoy	EVY	adWORDPROCESSOR	
PDF_Fmt	230	200	Adobe PDF (Portable Document Format)	application/pdf	PDF	adWORDPROCESSOR	kppdf2rdr , kppdfdrdr , pdf2sr , pdfsr
BinHex_Fmt	231	206	BinHex	application/mac-binhex40	HQX	adENCAPSULATION	kvhqxsr
SMTP_Fmt	232	207	SMTP (Text Mail / Outlook Express)	message/rfc822	SMTP	adENCAPSULATION	emlsr
MIME_Fmt	233	208	MIME (EML / MBX email) ¹	message/rfc822	EML, MBX	adENCAPSULATION	mbxsr
USENET_Fmt	234	264	USENET	message/news		adWORDPROCESSOR	
SGML_Fmt	235	209	SGML	text/sgml	SGML	adWORDPROCESSOR	afsr
HTML_Fmt	236	210	HTML	text/html	HTM, HTML	adWORDPROCESSOR	htmsr
ACT_Fmt	237	211	ACT! CRM software		ACT	adWORDPROCESSOR	
PNG_Fmt	238	213	Portable Network Graphics (PNG)	image/png	PNG	adRASTERIMAGE	kppngrdr , pngsr
MS_Video_Fmt	239	214	Video for Windows (AVI)	video/avi	AVI	adMOVIE	MCI
Windows_Animated_Cursor_Fmt	240	215	Windows Animated Cursor		ANI	adRASTERIMAGE	kpanirdr

Format Name	Number	Category	Description	MIME Type	Extension	File Class	Readers
Windows_CPP_Obj_Storage_Fmt	241	216	Windows C++ Object Storage			adMIXED	
Windows_Palette_Fmt	242	217	Windows Palette		PAL	adRASTERIMAGE	
RIFF_DIB_Fmt	243	218	RIFF Device Independent Bitmap			adRASTERIMAGE	
RIFF_MIDI_Fmt	244	219	RIFF MIDI	audio/midi	RMI	adSOUND	
RIFF_Multimedia_Movie_Fmt	245	220	RIFF Multimedia Movie		MMM	adMOVIE	
MPEG_Fmt	246	221	MPEG Movie	video/mpeg		adMOVIE	
QuickTime_Fmt	247	222	QuickTime Movie, MPEG-4 audio	video/quicktime	MOV, QT, MP4	adMOVIE	MCI , mpeg4sr
AIFF_Fmt	248	223	Audio Interchange File Format (AIFF)	audio/aiff	AIF, AIFF, AIFC	adSOUND	MCI , aifsr
Amiga_MOD_Fmt	249	224	Amiga MOD		MOD	adSOUND	
Amiga_IFF_8SVX_Fmt	250	225	Amiga IFF (8SVX) Sound	audio/x-8svx	IFF	adSOUND	
Creative_Voice_Audio_Fmt	251	226	Creative Voice (VOC)		VOC	adSOUND	
AutoDesk_Animator_FLI_Fmt	252	229	AutoDesk Animator FLIC	video/x-fli	FLI	adANIMATION	
AutoDesk_AnimatorPro_FLC_Fmt	253	230	AutoDesk Animator Pro FLIC	video/x-flc	FLC	adANIMATION	
Compactor_Archive_Fmt	254	233	Compactor / Compact Pro	application/mac-compactpro		adENCAPSULATION	
VRML_Fmt	255	234	VRML	model/vrml	WRL	adVECTORGRAPHIC	
QuickDraw_3D_Metfile_Fmt	256	235	QuickDraw 3D Metafile			adVECTORGRAPHIC	
PGP_Secret_Keyring_Fmt	257	236	PGP Secret Keyring	application/pgp		adENCAPSULATION	
PGP_Public_Keyring_Fmt	258	237	PGP Public Keyring	application/pgp		adENCAPSULATION	
PGP_Encrypted_Data_Fmt	259	238	PGP Encrypted Data	application/pgp		adENCAPSULATION	
PGP_Signed_Data_Fmt	260	239	PGP Signed Data	application/pgp		adENCAPSULATION	
PGP_SignedEncrypted_Data_Fmt	261	240	PGP Signed and Encrypted Data	application/pgp		adENCAPSULATION	

Format Name	Number	Category	Description	MIME Type	Extension	File Class	Readers
PGP_Sign_Certificate_Fmt	262	241	PGP Signature Certificate	application/pgp-signature	SIG	adENCAPSULATION	
PGP_Compressed_Data_Fmt	263	246	PGP Compressed Data	application/pgp		adENCAPSULATION	
PGP_ASCII_Public_Keyring_Fmt	264	242	ASCII-armored PGP Public Keyring	application/pgp	PGP	adENCAPSULATION	
PGP_ASCII_Encoded_Fmt	265	243	ASCII-armored PGP encoded	application/pgp		adENCAPSULATION	
PGP_ASCII_Signed_Fmt	266	244	ASCII-armored PGP signed	application/pgp		adENCAPSULATION	
OLE_DIB_Fmt	267	245	OLE DIB object			adRASTERIMAGE	
SGI_Image_Fmt	268	247	SGI RGB Image	image/sgi	RGB	adRASTERIMAGE	kpsgirDr
Lotus_ScreenCam_Fmt	269	248	Lotus ScreenCam	application/vnd.lotus-screencam	SCM	adANIMATION	
MPEG_Audio_Fmt	270	249	MPEG-1 Audio layer3 (MP3)	audio/mpeg	MPEGA, MPG, MP3	adSOUND	MCI , mp3sr
FTP_Software_Session_Fmt	271	250	FTP Session Data		STE	adCOMMUNICATION	
Netscape_Bookmark_File_Fmt	272	210	Netscape Bookmark File	text/html		adWORDPROCESSOR	htmsr
Corel_Draw_CMX_Fmt	273	252	Corel CMX	application/cmx	CMX	adVECTORGRAPHIC	
AutoDesk_DWG_Fmt	274	253	AutoDesk AutoCAD Drawing (DWG)	image/x-dwg	DWG	adVECTORGRAPHIC	kpDWGrDr , kpODArDr
AutoDesk_WHIP_Fmt	275	254	AutoDesk WHIP		WHP	adVECTORGRAPHIC	
Macromedia_Director_Fmt	276	255	Macromedia Shockwave/Adobe Director	application/x-director	DCR, DXR, DIR	adANIMATION	
Real_Audio_Fmt	277	256	Real Audio	audio/x-pn-realaudio	RM, RA	adSOUND	
MSDOS_Device_Driver_Fmt	278	257	MSDOS Device Driver	application/octet-stream	SYS	adEXECUTABLE	
Micrografx_Designer_Fmt	279	258	Micrografx Designer		DSF	adVECTORGRAPHIC	
SVF_Fmt	280	259	Simple Vector Format (SVF)	image/x-svf	SVF	adVECTORGRAPHIC	
Applix_Words_Fmt	281	261	Applix Words	application/x-applix-word	AW	adWORDPROCESSOR	awsr

Format Name	Number	Category	Description	MIME Type	Extension	File Class	Readers
Applix_Graphics_Fmt	282	262	Applix Graphics		AG	adPRESENTATION	kpagrdr
MS_Access_Fmt	283	263	Microsoft Access (versions 1 and 2)	application/x-msaccess	MDB	adDATABASE	mdbsr
MS_Access_95_Fmt	284	263	Microsoft Access 95	application/msaccess	MDB	adDATABASE	mdbsr
MS_Access_97_Fmt	285	263	Microsoft Access 97	application/msaccess	MDB	adDATABASE	mdbsr
MacBinary_Fmt	286	265	MacBinary	application/x-macbinary	BIN	adENCAPSULATION	macbinsr
Apple_Single_Fmt	287	266	Apple Single			adENCAPSULATION	
Apple_Double_Fmt	288	267	Apple Double	multipart/appledouble	AD	adENCAPSULATION	
Enhanced_Metafile_Fmt	289	270	Enhanced Metafile	image/x-emf	EMF	adVECTORGRAPHIC	kpemfrdr
MS_Office_Drawing_Fmt	290	271	Microsoft Office Drawing			adVECTORGRAPHIC	kpsmsordr
XML_Fmt	291	285	XML	text/xml	XML	adWORDPROCESSOR	xmlsr
DeVice_Independent_Fmt	292	274	DeVice Independent file (DVI)	application/x-dvi	DVI	adVECTORGRAPHIC	
Unicode_Fmt	293	275	Unicode text file	text/plain	UNI	adWORDPROCESSOR	unisir
Lotus_123_Worksheet_Fmt	294	81	Lotus 1-2-3	application/x-lotus-123	WKS, WK1, WK3, WK4	adSPREADSHEET	wkssr
Lotus_123_Format_Fmt	295	81	Lotus 1-2-3 Formatting	application/x-123	FM3	adSPREADSHEET	l123sr
Lotus_123_97_Fmt	296	81	Lotus 1-2-3 97	application/x-lotus-123	123	adSPREADSHEET	l123sr
Lotus_Word_Pro_96_Fmt	297	268	Lotus Word Pro 96	application/vnd.lotus-wordpro	LWP, MWP	adWORDPROCESSOR	lwpsr
Lotus_Word_Pro_97_Fmt	298	268	Lotus Word Pro 97	application/vnd.lotus-wordpro	LWP, MWP	adWORDPROCESSOR	lwpsr
Freelance_DOS_Fmt	299	140	Lotus Freelance for DOS	application/x-freelance	PRZ	adPRESENTATION	kppzrdr
Freelance_Win_Fmt	300	140	Lotus Freelance for Windows	application/x-freelance	PRE, FLW	adPRESENTATION	kpprerdr
Freelance_OS2_Fmt	301	140	Lotus Freelance for OS/2	application/x-freelance	PRS	adPRESENTATION	kpprerdr
Freelance_96_Fmt	302	140	Lotus Freelance 96	application/x-freelance	PRZ	adPRESENTATION	kppzrdr
Freelance_97_Fmt	303	140	Lotus Freelance 97	application/x-freelance	PRZ	adPRESENTATION	kppzrdr
MS_Word_95_Fmt	304	189	Microsoft Word 95	application/msword	DOC	adWORDPROCESSOR	mw6sr
MS_Word_97_Fmt	305	269	Microsoft Word 97	application/msword	DOC, WPS, WBK	adWORDPROCESSOR	mw8sr
Excel_Fmt	306	90	Microsoft Excel (up to version 5)	application/x-ms-excel	XLS	adSPREADSHEET	xlssr
Excel_Chart_Fmt	307	90	Microsoft Excel (up to	application/x-ms-excel	XLC	adSPREADSHEET	xlssr

Format Name	Number	Category	Description	MIME Type	Extension	File Class	Readers
			version 5) chart				
Excel_Macro_Fmt	308	90	Microsoft Excel (up to version 5) macro	application/vnd.ms-excel	XLM	adSPREADSHEET	xlssr
Excel_95_Fmt	309	188	Microsoft Excel 95	application/x-ms-excel	XLS	adSPREADSHEET	xlssr
Excel_97_Fmt	310	188	Microsoft Excel 97	application/x-ms-excel	XLS, XLR	adSPREADSHEET	xlssr
Corel_Presentations_Fmt	311	127	Corel Presentations	application/x-corelpresentations	XFD, XFDL	adPRESENTATION	kpswhrdr
Harvard_Graphics_Fmt	312	131	Harvard Graphics		PR4	adPRESENTATION	
Harvard_Graphics_Chart_Fmt	313	131	Harvard Graphics Chart		CH3, CHT	adVECTORGRAPHIC	
Harvard_Graphics_Symbol_Fmt	314	131	Harvard Graphics Symbol File (v3)		SY3	adVECTORGRAPHIC	
Harvard_Graphics_Cfg_Fmt	315	131	Harvard Graphics Configuration File			adVECTORGRAPHIC	
Harvard_Graphics_Palette_Fmt	316	131	Harvard Graphics Palette		PL	adVECTORGRAPHIC	
Lotus_123_R9_Fmt	317	81	Lotus 1-2-3 Release 9	application/x-lotus-123	123	adSPREADSHEET	l123sr
Applix_Spreadsheets_Fmt	318	278	Applix Spreadsheets	application/x-applix-spreadsheet	AS	adSPREADSHEET	assr
MS_Pocket_Word_Fmt	319	45	Microsoft Pocket Word		PWD	adWORDPROCESSOR	rfsr
MS_DIB_Fmt	320	279	Microsoft Device Independent Bitmap	image/bmp	DIB	adRASTERIMAGE	
MS_Word_2000_Fmt	321	269	Microsoft Word 2000	application/msword	DOC	adWORDPROCESSOR	mw8sr
Excel_2000_Fmt	322	188	Microsoft Excel 2000	application/x-ms-excel	XLS	adSPREADSHEET	xlssr
PowerPoint_2000_Fmt	323	272	Microsoft PowerPoint 2000	application/x-ms-powerpoint	PPT	adPRESENTATION	kpp97rdr
MS_Access_2000_Fmt	324	263	Microsoft Access 2000	application/x-msaccess	MDB	adDATABASE	mdbsr
MS_Project_4_Fmt	325	281	Microsoft Project 4		MPP	adSCHEDULE	mpps
MS_Project_41_Fmt	326	281	Microsoft Project 4.1		MPP	adSCHEDULE	mpps
MS_Project_98_Fmt	327	281	Microsoft Project 98	application/vnd.ms-project	MPP	adSCHEDULE	mpps
Folio_Flat_Fmt	328	282	Folio Flat File		FFF	adWORDPROCESSOR	foliosr
HWP_Fmt	329	283	Haansoft Hangul HWP (Arae-Ah Hangul)	application/x-hwp	HWP	adWORDPROCESSOR	hwpsr , hwpsr
ICHITARO_Fmt	330	284	ICHITARO (v4-10)	application/x-ichitaro	JTD	adWORDPROCESSOR	jtcsr

Format Name	Number	Category	Description	MIME Type	Extension	File Class	Readers
IS_XML_Fmt	331	273	Extended or Custom XML	text/xml	XML	adWORDPROCESSOR	
Oasys_Fmt	332	286	Fujitsu OASYS	application/vnd.fujitsu.oasys	OAS, OA2, OA3	adWORDPROCESSOR	oa2sr
PBM_ASC_Fmt	333	287	Portable Bitmap Utilities ASCII format (PBM)	image/pbm	PBM, PNM	adRASTERIMAGE	
PBM_BIN_Fmt	334	287	Portable Bitmap Utilities BINARY format (PBM)	image/pbm	PBM, PNM	adRASTERIMAGE	
PGM_ASC_Fmt	335	288	Portable Greymap Utilities ASCII format (PGM)	image/x-pgm	PGM, PNM	adRASTERIMAGE	
PGM_BIN_Fmt	336	288	Portable Greymap Utilities BINARY format (PGM)	image/x-pgm	PGM, PNM	adRASTERIMAGE	
PPM_ASC_Fmt	337	289	Portable Pixmap Utilities ASCII format (PPM)	image/x-portable-pixmap	PPM, PNM	adRASTERIMAGE	
PPM_BIN_Fmt	338	289	Portable Pixmap Utilities BINARY format (PPM)	image/x-portable-pixmap	PPM, PNM	adRASTERIMAGE	
XBM_Fmt	339	290	X Bitmap format (XBM)	image/x-bitmap	XBM	adRASTERIMAGE	
XPM_Fmt	340	291	X Pixmap format (XPM)	image/xpm	XPM	adRASTERIMAGE	
FPX_Fmt	341	292	Kodak FlashPix FPX Image format	image/fpx	FPX	adRASTERIMAGE	olesr
PCD_Fmt	342	293	PCD Image format	image/pcd	PCD	adRASTERIMAGE	
MS_Visio_Fmt	343	294	Microsoft Visio (up to version 11)	image/x-vsd	VSD	adPRESENTATION	kpVSD2rdr , vsdsr
MS_Project_2000_Fmt	344	281	Microsoft Project 2000	application/vnd.ms-project	MPP	adSCHEDULE	mpps
MS_Outlook_Fmt	345	295	Microsoft Outlook message	application/vnd.ms-outlook	MSG, OFT	adENCAPSULATION	msgsr
ELF_Relocatable_Fmt	346	159	ELF Relocatable	application/octet-stream	O	adOBJECTMODULE	
ELF_Executable_Fmt	347	158	ELF Executable	application/octet-stream		adEXECUTABLE	
ELF_Dynamic_Lib_Fmt	348	160	ELF Dynamic Library	application/octet-stream	SO	adLIBRARY	
MS_Word_XML_Fmt	349	285	Microsoft Word 2003 XML	text/xml	XML	adWORDPROCESSOR	xmlsr
MS_Excel_XML_Fmt	350	285	Microsoft Excel 2003 XML	text/xml	XML	adWORDPROCESSOR	xmlsr
MS_Visio_XML_Fmt	351	285	Microsoft Visio 2003 XML	text/xml	VDX	adWORDPROCESSOR	xmlsr
SO_Text_XML_Fmt	352	314	OpenDocument format (OpenOffice 1/StarOffice 6,7) Text XML	application/vnd.sun.xml.writer	SXW	adWORDPROCESSOR	odfwpsr

Format Name	Number	Category	Description	MIME Type	Extension	File Class	Readers
SO_Spreadsheet_XML_Fmt	353	315	OpenDocument format (OpenOffice 1/StarOffice 6,7) Spreadsheet XML	application/vnd.sun.xml.calc	SXC, STC	adSPREADSHEET	sosr
SO_Presentation_XML_Fmt	354	316	OpenDocument format (OpenOffice 1/StarOffice 6,7) Presentation XML	application/vnd.sun.xml.impress	SXD, SXI	adPRESENTATION	kpodfrdr
XHTML_Fmt	355	296	XHTML	text/xhtml	XML, XHTML, XHT	adWORDPROCESSOR	
MS_OutlookPST_Fmt	356	297	Microsoft Outlook Personal Folders File (.pst)	application/vnd.ms-outlook-pst	PST	adENCAPSULATION	pstnsr , pstr , pstxsr
RAR_Fmt	357	298	RAR archive format	application/x-rar-compressed	RAR, REV, R00, R01	adENCAPSULATION, adEXECUTABLE	rarsr
Lotus_Notes_NSF_Fmt	358	299	IBM Lotus Notes Database NSF/NTF	application/x-lotus-notes	NSF	adENCAPSULATION	nsfsr
Macromedia_Flash_Fmt	359	300	Macromedia Flash (.swf)	application/x-shockwave-flash	SWF, SWD	adWORDPROCESSOR	swfsr
MS_Word_2007_Fmt	360	301	Microsoft Word 2007 XML - Docx	application/x-ms-word07	DOCX, DOTX	adWORDPROCESSOR	mwxsr
MS_Excel_2007_Fmt	361	302	Microsoft Excel 2007 XML	application/x-ms-excel07	XLSX, XLTX	adSPREADSHEET	xlsxsr
MS_PPT_2007_Fmt	362	303	Microsoft PowerPoint 2007 XML	application/x-ms-powerpoint07	PPTX, POTX, PPSX	adPRESENTATION	kpppxrdr
OpenPGP_Fmt	363	304	OpenPGP Message Format (with new packet format)	application/pgp-encrypted	PGP	adENCAPSULATION	
Intergraph_V7_DGN_Fmt	364	305	Intergraph Standard File Format (ISFF) V7 DGN (non-OLE)		DGN	adVECTORGRAPHIC	
MicroStation_V8_DGN_Fmt	365	306	MicroStation V8 DGN (OLE)		DGN	adVECTORGRAPHIC	olesr
MS_Word_Macro_2007_Fmt	366	307	Microsoft Word Macro 2007 XML	application/x-ms-word07m	DOCM, DOTM	adWORDPROCESSOR	mwxsr
MS_Excel_Macro_2007_Fmt	367	308	Microsoft Excel Macro 2007 XML	application/x-ms-excel07m	XLSM, XLTM, XLAM	adSPREADSHEET	xlsxsr
MS_PPT_Macro_2007_Fmt	368	309	Microsoft PPT Macro 2007 XML	application/x-ms-powerpoint07m	PPTM, POTM, PPSM, PPAM	adPRESENTATION	kpppxrdr
LZH_Fmt	369	310	LZH Archive	application/x-lzh-compressed	LZH, LHA	adENCAPSULATION	lzhsr
Office_2007_Fmt	370	311	Office 2007 document		XLSB	adMISC	

Format Name	Number	Category	Description	MIME Type	Extension	File Class	Readers
MS_XPS_Fmt	371	312	Microsoft Open XML Paper Specification (XPS/OXPS)	application/vnd.ms-xpsdocument	XPS, OXPS	adWORDPROCESSOR	xpssr
Lotus_Domino_DXL_Fmt	372	313	IBM Domino Data in XML format (.dxl)	text/xml	DXL	adENCAPSULATION	dxlsr
ODF_Text_Fmt	373	314	ODF Text	application/vnd.oasis.opendocument.text	ODT	adWORDPROCESSOR	odfwpsr
ODF_Spreadsheet_Fmt	374	315	ODF Spreadsheet	application/vnd.oasis.opendocument.spreadsheet	ODS	adSPREADSHEET	odfsssr
ODF_Presentation_Fmt	375	316	ODF Presentation	application/vnd.oasis.opendocument.presentation	ODP	adPRESENTATION	kpodfrdr
Legato_Extender_ONM_Fmt	376	317	Legato Extender Native Message ONM	application/x-lotus-notes	ONM	adENCAPSULATION	onmsr
bin_Unknown_Fmt	377	318	Bin unknown format (.xxx)			adWORDPROCESSOR	
TNEF_Fmt	378	319	Transport Neutral Encapsulation Format (TNEF)	application/vnd.ms-tnef		adENCAPSULATION	tnefsr
CADAM_Drawing_Fmt	379	320	CADAM Drawing		CDD	adVECTORGRAPHIC	
CADAM_Drawing_Overlay_Fmt	380	321	CADAM Drawing Overlay		CDO	adVECTORGRAPHIC	
NURSTOR_Drawing_Fmt	381	322	NURSTOR Drawing		NUR	adVECTORGRAPHIC	
HP_GLP_Fmt	382	323	HP Graphics Language (Plotter)	vector/x-hpgl2	HPG	adVECTORGRAPHIC	
ASF_Fmt	383	324	Advanced Systems Format (ASF)	application/x-ms-asf	ASF	adMISC	asfsr
WMA_Fmt	384	325	Windows Media Audio Format (WMA)	audio/x-ms-wma	WMA	adSOUND	asfsr
WMV_Fmt	385	326	Windows Media Video Format (WMV)	video/x-ms-wmv	WMV	adMOVIE	asfsr
EMX_Fmt	386	327	Legato EMailXtender Archives Format (EMX)		EMX	adENCAPSULATION	emxsr
Z7Z_Fmt	387	328	7-Zip archive (7z)	application/7z	7Z	adENCAPSULATION, adEXECUTABLE	z7zsr
MS_Excel_Binary_2007_Fmt	388	329	Microsoft Excel Binary 2007	application/vnd.ms-excel.sheet.binary.macroenabled.12	XLSB	adSPREADSHEET	xlsbsr
CAB_Fmt	389	330	Microsoft Cabinet File (CAB)	application/vnd.ms-cab-compressed	CAB	adENCAPSULATION	cabsr
CATIA_Fmt	390	331	CATIA Formats (CAT*)		CATPART,	adVECTORGRAPHIC	kpCATrdr

Format Name	Number	Category	Description	MIME Type	Extension	File Class	Readers
					CATPRODUCT ²		
YIM_Fmt	391	332	Yahoo! Instant Messenger History		DAT	adWORDPROCESSOR	yimsr
ODF_Drawing_Fmt	392	316	ODF Drawing/Graphics	application/vnd.oasis.opendocument.graphics	ODG	adVECTORGRAPHIC	kpodfrdr
Founder_CEB_Fmt	393	333	Founder Chinese E-paper Basic (ceb)	application/ceb	CEB	adWORDPROCESSOR	cebsr
QPW_Fmt	394	334	Corel Quattro Pro 9+ for Windows	application/quattro-pro	QPW	adSPREADSHEET	qpwsr
MHT_Fmt	395	335	MIME HTML MHTML format (MHT) ¹	multipart/related	MHT, MHTML	adWORDPROCESSOR	mhtsr
MDI_Fmt	396	336	Microsoft Document Imaging Format	image/vnd.ms-modi	MDI	adRASTERIMAGE	
GRV_Fmt	397	337	Microsoft Office Groove Format	application/vnd.groove-injector	GRV	adWORDPROCESSOR	
IWWP_Fmt	398	338	Apple iWork Pages format	application/vnd.apple.pages	PAGES	adWORDPROCESSOR	iwpsr
IWSS_Fmt	399	339	Apple iWork Numbers format	application/vnd.apple.numbers	NUMBERS	adSPREADSHEET	iwsssr
IWPG_Fmt	400	340	Apple iWork Keynote format	application/vnd.apple.keynote	KEY	adPRESENTATION	kplWPGrdr
BKF_Fmt	401	341	Microsoft Windows Backup File		BKF	adENCAPSULATION	bkfsr
MS_Access_2007_Fmt	402	342	Microsoft Access 2007	application/msaccess	ACCDB	adDATABASE	mdbsr
ENT_Fmt	403	343	Microsoft Entourage Database Format			adENCAPSULATION	entsr
DMG_Fmt	404	344	Mac Disk Copy Disk Image File	application/x-apple-diskimage	DMG	adENCAPSULATION	dmgsr
CWK_Fmt	405	345	AppleWorks (Claris Works) File	application/appleworks	CWK	adWORDPROCESSOR	stringssr
OO3_Fmt	406	346	Omni Outliner V3 File		OO3	adWORDPROCESSOR	oo3sr
OPML_Fmt	407	347	Omni Outliner OPML File		OPML	adWORDPROCESSOR	oo3sr
Omni_Graffle_XML_Fmt	408	348	Omni Graffle XML File		GRAFFLE	adVECTORGRAPHIC	kpgFLrdr
PSD_Fmt	409	349	Adobe Photoshop Document	image/vnd.adobe.photoshop	PSD, PSB	adRASTERIMAGE	psdsr
Apple_Binary_PLList_Fmt	410	350	Apple Binary Property List	application/x-bplist	PLIST	adMISC	

Format Name	Number	Category	Description	MIME Type	Extension	File Class	Readers
			format				
Apple_iChat_Fmt	411	351	Apple iChat format		ICHAT	adWORDPROCESSOR	ichatsr
OOOUTLINE_Fmt	412	352	OOutliner File		OOOUTLINE	adWORDPROCESSOR	oo3sr
BZIP2_Fmt	413	353	Bzip 2 Compressed File	application/x-bzip2	BZ2	adENCAPSULATION	bzip2sr
ISO_Fmt	414	354	ISO-9660 CD Disc Image Format	application/x-iso9660-image	ISO	adENCAPSULATION	isosr
DocuWorks_Fmt	415	355	DocuWorks Format	application/vnd.fujixerox.docuworks	XDW	adWORDPROCESSOR	
RealMedia_Fmt	416	356	RealMedia Streaming Media	application/vnd.rm-realmedia	RM, RA	adMOVIE	
AC3Audio_Fmt	417	357	AC3 Audio File Format	audio/ac3	AC3	adSOUND	
NEF_Fmt	418	358	Nero Encrypted File		NEF	adENCAPSULATION	
SolidWorks_Fmt	419	359	SolidWorks Format Files		SLDASM, SLDPRT, SLDDRW, SLDDRT	adVECTORGRAPHIC	olesr
XFDL_Fmt	420	366	Extensible Forms Description Language	application/x-xfdl	XFDL, XFD	adPRESENTATION	kpXFDLrdr
Apple_XML_PList_Fmt	421	367	Apple XML Property List format	application/x-plist	PLIST	adMISC	
OneNote_Fmt	422	368	Microsoft OneNote Note Format	application/onenote	ONE	adWORDPROCESSOR	onesr
IFilter_Fmt	423	369	iFilter			adWORDPROCESSOR	
Dicom_Fmt	424	370	Digital Imaging and Communications in Medicine (Dicom)	application/dicom	DCM	adRASTERIMAGE	dcmsr
EnCase_Fmt	425	371	Expert Witness Compression Format (EnCase)		E01, L01, Lx01	adENCAPSULATION	encase2sr , encasesr
Scrap_Fmt	426	372	Shell Scrap Object File		SHS	adENCAPSULATION	olesr
MS_Project_2007_Fmt	427	373	Microsoft Project 2007	application/vnd.ms-project	MPP	adSCHEDULE	mppsrr
MS_Publisher_98_Fmt	428	374	Microsoft Publisher from version 98	application/x-mspublisher	PUB	adDESKTOPPUBLSH	mspubsr
Skype_Fmt	429	375	Skype Log File		DBB	adWORDPROCESSOR	skypesr
HL7_Fmt	430	377	Health level7 message		HL7	adWORDPROCESSOR	hl7sr

Format Name	Number	Category	Description	MIME Type	Extension	File Class	Readers
MS_OutlookOST_Fmt	431	378	Microsoft Outlook Offline Folders File (OST)	application/vnd.ms-outlook-pst	OST	adENCAPSULATION	pffsr
Epub_Fmt	432	379	Open Publication Structure electronic publication	application/epub+zip	EPUB	adWORDPROCESSOR	epubsr
MS_OEDBX_Fmt	433	380	Microsoft Outlook Express DBX Message Database		DBX	adENCAPSULATION	dbxsr
BB_Activ_Fmt	434	381	BlackBerry Activation File		DAT	adWORDPROCESSOR	
DiskImage_Fmt	435	382	Disk Image		DMG	adENCAPSULATION	
Milestone_Fmt	436	383	Milestone Document		MLS, ML3, ML4, ML5, ML6, ML7, ML8, ML9, MLA	adRASTERIMAGE	
E_Transcript_Fmt	437	384	RealLegal E-Transcript File		PTX	adWORDPROCESSOR	
PostScript_Font_Fmt	438	385	PostScript Type 1 Font	application/x-font	PFB	adFONT	pfasar
Ghost_DiskImage_Fmt	439	386	Ghost Disk Image File		GHO, GHS	adENCAPSULATION	
JPEG_2000_JP2_File_Fmt	440	387	JPEG-2000 JP2 File Format Syntax (ISO/IEC 15444-1)	image/jp2	JP2, JPF, J2K, JPWL, JPX, PGX	adRASTERIMAGE	jp2000sr , kjpj2000rdr
Unicode_HTML_Fmt	441	388	Unicode HTML	text/html	HTM, HTML	adWORDPROCESSOR	unihtmsr
CHM_Fmt	442	389	Microsoft Compiled HTML Help	application/x-chm	CHM	adENCAPSULATION	chmsr
EMCMF_Fmt	443	390	Documentum EMCMF format		EMCMF	adENCAPSULATION	msgsr
MS_Access_2007_Tmpl_Fmt	444	391	Microsoft Access 2007 Template		ACCDT	adDATABASE	
Jungum_Fmt	445	392	Samsung Electronics Jungum Global document	application/jungum	GUL	adWORDPROCESSOR	
JBIG2_Fmt	446	393	JBIG2 File Format	image/jbig2	JB2, JBIG2	adRASTERIMAGE	kpJBIG2rdr
EFax_Fmt	447	394	eFax file		EFX	adRASTERIMAGE	
AD1_Fmt	448	395	AD1 Evidence file		AD1	adENCAPSULATION	ad1sr
SketchUp_Fmt	449	396	Google SketchUp		SKP	adVECTORGRAPHIC	
GWFS_Email_Fmt	450	397	GroupWise FileSurf email		GWFS	adENCAPSULATION	gwfsr
JNT_Fmt	451	398	Windows Journal format		JNT	adWORDPROCESSOR	

Format Name	Number	Category	Description	MIME Type	Extension	File Class	Readers
Yahoo_yChat_Fmt	452	399	Yahoo! Messenger chat log		YCHAT	adWORDPROCESSOR	
PaperPort_MAX_File_Fmt	453	400	PaperPort MAX image file	image/max	MAX	adRASTERIMAGE	
ARJ_Fmt	454	402	ARJ (Archive by Robert Jung) file format	application/arj	ARJ	adENCAPSULATION	multiarcslr
RPMSG_Fmt	455	403	Microsoft Outlook Restricted Permission Message	application/x-microsoft-rpmsg-message	RPMSG	adENCAPSULATION	
MAT_Fmt	456	404	MATLAB file format	application/x-matlab-data	MAT, FIG	adWORDPROCESSOR	
SGY_Fmt	457	405	SEG-Y Seismic Data format		SGY, SEGY	adWORDPROCESSOR	
CDXA_MPEG_PS_Fmt	458	406	MPEG-PS container with CDXA stream	video/mpeg	MPG	adMOVIE	
EVT_Fmt	459	407	Microsoft Windows NT Event Log		EVT	adMISC	
EVTX_Fmt	460	408	Microsoft Windows Vista Event Log		EVTX	adMISC	
MS_OutlookOLM_Fmt	461	409	Microsoft Outlook for Macintosh format		OLM	adENCAPSULATION	olmsr
WARC_Fmt	462	410	Web ARChive	application/warc	WARC	adENCAPSULATION	
JAVACLASS_Fmt	463	411	Java Class format	application/x-java-class	CLASS	adWORDPROCESSOR	
VCF_Fmt	464	412	Microsoft Outlook vCard file format	text/vcard	VCF	adWORDPROCESSOR	vcfsr
EDB_Fmt	465	413	Microsoft Exchange Server Database file format		EDB	adENCAPSULATION	
ICS_Fmt	466	414	Microsoft Outlook iCalendar file format	text/calendar	ICS, VCS	adENCAPSULATION	icssr
MS_Visio_2013_Fmt	467	415	Microsoft Visio 2013	application/vnd.visio	VSDX, VSTX, VSSX	adPRESENTATION	ActiveX components, kpVSDXrdr
MS_Visio_2013_Macro_Fmt	468	415	Microsoft Visio 2013 macro	application/vnd.visio	VSDM, VSTM, VSSM	adPRESENTATION	kpVSDXrdr
ICHITARO_Compr_Fmt	469	417	ICHITARO Compressed format	application/x-js-taro	JTDC	adWORDPROCESSOR	jtdsr

Format Name	Number	Category	Description	MIME Type	Extension	File Class	Readers
IWWP13_Fmt	470	418	Apple iWork 2013 Pages format		IWA, PAGES	adWORDPROCESSOR	iwwp13sr
IWSS13_Fmt	471	419	Apple iWork 2013 Numbers format		IWA, NUMBERS	adSPREADSHEET	iwss13sr
IWPG13_Fmt	472	420	Apple iWork 2013 Keynote format		IWA, KEY	adPRESENTATION	kplWPG13rdr , kplWPGrdr
XZ_Fmt	473	421	XZ archive format	application/x-xz	XZ	adENCAPSULATION	multiarcsr
Sony_WAVE64_Fmt	474	422	Sony Wave64 format	audio/wav64	W64	adSOUND	
Conifer_WAVPACK_Fmt	475	423	Conifer Wavpack format	audio/x-wavpack	WV	adSOUND	
Xiph_OGG_VORBIS_Fmt	476	424	Xiph Ogg Vorbis format	audio/ogg	OGG	adSOUND	
MS_Visio_2013_Stencil_Fmt	477	415	MS Visio 2013 stencil format	application/vnd.visio	VSSX	adPRESENTATION	kpVSDXrdr
MS_Visio_2013_Stencil_Macro_Fmt	478	415	MS Visio 2013 stencil Macro format	application/vnd.visio	VSSM	adPRESENTATION	kpVSDXrdr
MS_Visio_2013_Template_Fmt	479	415	MS Visio 2013 template format	application/vnd.visio	VSTX	adPRESENTATION	kpVSDXrdr
MS_Visio_2013_Template_Macro_Fmt	480	415	MS Visio 2013 template Macro format	application/vnd.visio	VSTM	adPRESENTATION	kpVSDXrdr
Borland_Reflex_2_Fmt	481	425	Borland Reflex 2 format		R2D	adDATABASE	
PKCS_12_Fmt	482	426	PKCS #12 (p12) format	application/x-pkcs12	P12, PFX	adWORDPROCESSOR	
B1_Fmt	483	427	B1 format	application/x-b1	B1	adENCAPSULATION	b1sr
ISO_IEC_MPEG_4_Fmt	484	428	ISO/IEC MPEG-4 (ISO 14496) format	video/mp4	MP4	adMOVIE	mpeg4sr
RAR5_Fmt	485	429	RAR5 Format	application/x-rar-compressed	RAR	adENCAPSULATION	multiarcsr
Unigraphics_NX_Fmt	486	362	Unigraphics (UG) NX CAD Format		PRT	adVECTORGRAPHIC	kpUGrdr
PTC_Creo_Fmt	487	430	PTC Creo CAD Format		ASM, PRT	adVECTORGRAPHIC	
KML_Fmt	488	431	Keyhole Markup Language	application/vnd.google-earth.kml+xml	KML	adWORDPROCESSOR	xmlsr
KMZ_Fmt	489	432	Zipped Keyhole Markup Language	application/vnd.google-earth.kmz	KMZ	adWORDPROCESSOR	unzip
WML_Fmt	490	433	Wireless Markup Language	text/vnd.wap.wml	WML	adWORDPROCESSOR	xmlsr
ODF_Formula_Fmt	491	434	ODF Formula	application/vnd.oasis.opendocument.formula	ODF	adWORDPROCESSOR	unzip

Format Name	Number	Category	Description	MIME Type	Extension	File Class	Readers
SO_Text_Fmt	492	435	Star Office 4,5 Writer Text	application/vnd.stardivision.writer	SDW, SGL, VOR	adWORDPROCESSOR	kpsdwrdr , starwsr
SO_Spreadsheet_Fmt	493	436	Star Office 4,5 Calc Spreadsheet	application/vnd.stardivision.calc	SDC	adSPREADSHEET	starcsr
SO_Presentation_Fmt	494	437	Star Office 4,5 Impress Presentation	application/vnd.stardivision.draw	SDD, SDA	adPRESENTATION	kpsddrdr
SO_Math_Fmt	495	438	Star Office 4,5 Math	application/vnd.stardivision.math	SMF	adMISC	olesr
STEP_Fmt	496	439	ISO 10303-21 STEP format			adMISC	
STL_Fmt	497	364	3D Systems Stereo Lithography STL ASCII format			adCAD	
AppleScript_Fmt	498	440	AppleScript Source Code ³	text/x-applescript	APPLESCRIPT	adSOURCECODE	afsr
Assembly_Fmt	499	441	Assembly Code ³	text/x-assembly		adSOURCECODE	afsr
C_Fmt	500	442	C Source Code ³	text/x-c	C, H	adSOURCECODE	afsr
Csharp_Fmt	501	443	C# Source Code ³	text/x-csharp	CS	adSOURCECODE	afsr
CPlusPlus_Fmt	502	444	C++ Source Code ³	text/x-c++	CPP, HPP	adSOURCECODE	afsr
Css_Fmt	503	445	Cascading Style Sheet ³	text/css	CSS	adSOURCECODE	afsr
Clojure_Fmt	504	446	Clojure Source Code ³	text/x-clojure	CLJ, CL2	adSOURCECODE	afsr
CoffeeScript_Fmt	505	447	CoffeeScript Source Code ³	text/x-coffeescript	COFFEE, CAKE	adSOURCECODE	afsr
Lisp_Fmt	506	448	Common Lisp Source Code ³	text/x-common-lisp	EL	adSOURCECODE	afsr
Dockerfile_Fmt	507	449	Dockerfile ³	text/x-dockerfile		adSOURCECODE	afsr
Eiffel_Fmt	508	450	Eiffel Source Code ³	text/x-eiffel	E	adSOURCECODE	afsr
Erlang_Fmt	509	451	Erlang Source Code ³	text/x-erlang	ERL, ES	adSOURCECODE	afsr
Fsharp_Fmt	510	452	F# Source Code ³	text/x-fsharp	FS	adSOURCECODE	afsr
Fortran_Fmt	511	453	Fortran Source Code ³	text/x-fortran	F	adSOURCECODE	afsr
Go_Fmt	512	454	Go Source Code ³	text/x-go	GO	adSOURCECODE	afsr
Groovy_Fmt	513	455	Groovy Source Code ³	text/x-groovy	GRT, GUY	adSOURCECODE	afsr
Haskell_Fmt	514	456	Haskell Source Code ³	text/x-haskell	HS	adSOURCECODE	afsr
Ini_Fmt	515	457	Initialization (INI) file ³	text/x-ini		adSOURCECODE	afsr

Format Name	Number	Category	Description	MIME Type	Extension	File Class	Readers
Java_Fmt	516	458	Java Source Code ³	text/x-java-source	JAVA	adSOURCECODE	afsr
Javascript_Fmt	517	459	Javascript Source Code ³	text/javascript	JS	adSOURCECODE	afsr
Lua_Fmt	518	460	Lua Source Code ³	text/x-lua	LUA	adSOURCECODE	afsr
Makefile_Fmt	519	461	Makefile ³	text/x-makefile	MAKE	adSOURCECODE	afsr
Mathematica_Fmt	520	462	Wolfram Mathematica Source Code ³	text/x-mathematica	M	adSOURCECODE	afsr
ObjC_Fmt	521	464	Objective-C Source Code ³	text/x-objc		adSOURCECODE	afsr
ObjCpp_Fmt	522	465	Objective-C++ Source Code ³	text/x-objectivec++		adSOURCECODE	afsr
ObjJ_Fmt	523	466	Objective-J Source Code ³	text/x-objectivej	J	adSOURCECODE	afsr
PHP_Fmt	524	467	PHP Source Code ³	text/x-php	PHP	adSOURCECODE	afsr
PLSQL_Fmt	525	468	PLSQL Source Code ³	text/x-plsql		adSOURCECODE	afsr
Pascal_Fmt	526	469	Pascal Source Code ³	text/x-pascal	PASCAL	adSOURCECODE	afsr
Perl_Fmt	527	470	Perl Source Code ³	text/x-perl	PL	adSOURCECODE	afsr
Powershell_Fmt	528	471	PowerShell Source Code ³	text/x-powershell	PS1	adSOURCECODE	afsr
Prolog_Fmt	529	472	Prolog Source Code ³	text/x-prolog	PRO, PROLOG	adSOURCECODE	afsr
Puppet_Fmt	530	473	Puppet Source Code ³	text/x-puppet	PP	adSOURCECODE	afsr
Python_Fmt	531	474	Python Source Code ³	text/x-python	PY	adSOURCECODE	afsr
R_Fmt	532	475	R Source Code ³	text/x-rsrc	R	adSOURCECODE	afsr
Ruby_Fmt	533	476	Ruby Source Code ³	text/x-ruby	RB	adSOURCECODE	afsr
Rust_Fmt	534	477	Rust Source Code ³	text/x-rust	RS	adSOURCECODE	afsr
Scala_Fmt	535	478	Scala Source Code ³	text/x-scala	SC	adSOURCECODE	afsr
Shell_Fmt	536	479	Shell Script ³	application/x-sh	SH	adSOURCECODE	afsr
Smalltalk_Fmt	537	480	Smalltalk Source Code ³	text/x-stsrc	ST	adSOURCECODE	afsr
ML_Fmt	538	481	Standard ML Source Code ³	text/x-ml	ML	adSOURCECODE	afsr
Swift_Fmt	539	482	Swift Source Code ³	text/x-swift	SWIFT	adSOURCECODE	afsr
Tcl_Fmt	540	483	Tool Command Language (Tcl) Source Code ³	text/x-tcl	TM	adSOURCECODE	afsr
Tex_Fmt	541	484	TeX Typesetting File ³	application/x-tex		adSOURCECODE	afsr

Format Name	Number	Category	Description	MIME Type	Extension	File Class	Readers
TypeScript_Fmt	542	485	TypeScript Source Code ³	text/x-typescript	TS	adSOURCECODE	afsr
Verilog_Fmt	543	486	Verilog Source Code ³	text/x-verilog	V	adSOURCECODE	afsr
YAML_Fmt	544	487	YAML File ³	text/x-yaml	YML	adSOURCECODE	afsr
Wiki_Fmt	545	488	MediaWiki File	text/x-mediawiki		adWORDPROCESSOR	afsr
MS_Word_2007_Flat_XML_Fmt	546	301	Microsoft Word 2007 XML - Flat xml	text/xml	XML	adWORDPROCESSOR	mwxsr
Matroska_Fmt	547	489	Matroska video File	video/x-matroska	MKV	adMOVIE	
SVG_Fmt	548	490	Scalable Vector Graphics image	image/svg+xml	SVG	adVECTORGRAPHIC	xmlsr
Shapefile_Fmt	549	491	Shapefile	application/x-shapefile	SHP, SHX	adGIS	
Flash_Video_Fmt	550	492	Flash video File	video/x-flv	FLV	adMOVIE	
Embedded_OpenType_Fmt	551	493	Embedded OpenType font	application/vnd.ms-fontobject	EOT	adFONT	
Web_Open_Font_Fmt	552	494	Web Open Font Format	font/woff	WOFF, WOFF2	adFONT	
OpenType_Fmt	553	495	OpenType Font	font/otf	OTF	adFONT	
MNG_Fmt	554	496	Multiple-image Network Graphics	video/x-mng	MNG	adANIMATION	
JNG_Fmt	555	497	JPEG Network Graphics	image/x-jng	JNG	adRASTERIMAGE	
AppleScript_Binary_Fmt	556	498	AppleScript Binary Source Code		SCPT	adSOURCECODE	
Maya_Binary_Fmt	557	499	Autodesk Maya binary file		MB	adCAD	
Jupiter_Tesselation_Fmt	558	363	UGS Jupiter Tesselation file		JT	adCAD	
OGV_Fmt	559	500	Ogg Theora Video format	video/ogg	OGV	adMOVIE	
OGG_Container_Fmt	560	501	General Ogg Container format	application/ogg	OGG	adMISC	
GNU_Message_Catalog_Fmt	561	502	GNU Message Catalog format		MO	adMISC	
Windows_Shortcut_Fmt	562	503	Windows shortcut file	application/x-ms-shortcut	LNK	adMISC	
Apple_Typedstream_Fmt	563	504	Apple/NeXT typedstream data format			adMISC	
XCF_Fmt	564	505	GIMP XCF image	image/x-xcf	XCF	adRASTERIMAGE	

Format Name	Number	Category	Description	MIME Type	Extension	File Class	Readers
PaintShop_Pro_Fmt	565	506	PaintShop Pro image		PSP, PSPIMAGE	adRASTERIMAGE	
SQLite_Database_Fmt	566	507	SQLite database format	application/x-sqlite3	QHC	adDATABASE	
MySQL_Table_Fmt	567	508	MySQL table definition file		FRM	adDATABASE	
Microsoft_Program_DB_Fmt	568	509	Microsoft Program Database format		PDB	adDATABASE	
OpenEXR_Fmt	569	510	OpenEXR image format		EXR	adRASTERIMAGE	
XMV_Fmt	570	511	4X Movie File		4XM	adMOVIE	
AMV_Fmt	571	512	AMV video file		AMV	adMOVIE	
NIFF_Fmt	572	513	Notation Interchange File Format		NIF	adSOUND	
CuBase_Fmt	573	514	Steinberg CuBase file			adSOUND	
SoundFont_Fmt	574	515	SoundFont file			adSOUND	
WebP_Fmt	575	516	WebP image	image/webp	WEBP	adRASTERIMAGE	
ICC_Fmt	576	517	International Color Consortium files	application/vnd.iccprofile	ICC, ICM	adMISC	
PCF_Fmt	577	518	X11 Portable Compiled Font file	application/x-font-pcf	PCF	adFONT	
WebM_Fmt	578	519	WebM video file	video/webm	WEBM	adMOVIE	
AMFF_Fmt	579	520	Amiga Metafile		AMF	adVECTORGRAPHIC	
ANBM_Fmt	580	521	IFF Animated Bitmap			adRASTERIMAGE	
ANIM_Fmt	581	522	IFF Amiga animated raster graphics format			adRASTERIMAGE	
DEEP_Fmt	582	523	IFF-DEEP TVPaint image		DEEP	adRASTERIMAGE	
FAXX_Fmt	583	524	IFF-FAXX Facsimile image			adRASTERIMAGE	
ICON_Fmt	584	525	IFF Glow Icon image			adRASTERIMAGE	
ILBM_Fmt	585	526	Interleaved BitMap image		IFF	adRASTERIMAGE	
LWOB_Fmt	586	527	LightWave Object format		LWOB	adMISC	
MAUD_Fmt	587	528	IFF-MAUD MacroSystem audio format			adSOUND	
PBM_Fmt	588	529	IFF Planar BitMap			adRASTERIMAGE	

Format Name	Number	Category	Description	MIME Type	Extension	File Class	Readers
TDDD_Fmt	589	530	IFF TDDD and Imagine Object animation format		TDD	adRASTERIMAGE	
DjVu_Fmt	590	531	AT&T DjVu format	image/vnd.djvu	DJVU	adWORDPROCESSOR	
InDesign_Fmt	591	532	Adobe InDesign document	application/x-indesign	INDD	adDESKTOPPUBLSH	
Calamus_Fmt	592	533	Calamus Desktop Publishing			adDESKTOPPUBLSH	
Adaptive_MultiRate_Fmt	593	534	Adaptive Multi-Rate audio format	audio/amr	AMR	adSOUND	
FLAC_Fmt	594	535	Free Lossless Audio Codec format	audio/flac	FLAC	adSOUND	
Ogg_FLAC_Fmt	595	536	Ogg Container FLAC audio format		OGG	adSOUND	
SAS7BDAT_Fmt	596	537	SAS7BDAT database storage format		SAS7BDAT	adDATABASE	sassr
Design_Web_Format_Fmt	597	538	Autodesk Design Web Format	model/vnd.dwf	DWF	adCAD	
Adobe_Flash_Audio_Book_Fmt	598	539	Adobe Flash Player audio book	audio/mp4	F4B	adSOUND	mpeg4sr
Adobe_Flash_Audio_Fmt	599	540	Adobe Flash Player audio	audio/mp4	F4A	adSOUND	mpeg4sr
Adobe_Flash_Protected_Video_Fmt	600	541	Adobe Flash Player protected video	video/mp4	F4P	adMOVIE	mpeg4sr
Adobe_Flash_Video_Fmt	601	542	Adobe Flash Player video	video/x-f4v	F4V	adMOVIE	mpeg4sr
Audible_Audiobook_Fmt	602	543	Audible Enhanced Audiobook	audio/vnd.audible.aax	AAX	adSOUND	mpeg4sr
Canon_Camera_Fmt	603	544	Canon Digital Camera image			adRASTERIMAGE	
Canon_Raw_Fmt	604	545	Canon Raw image		CR3	adRASTERIMAGE	
Casio_Camera_Fmt	605	546	Casio Digital Camera image			adRASTERIMAGE	
Convergent_Design_Fmt	606	547	Convergent Design file			adRASTERIMAGE	
DMB_MAF_Audio_Fmt	607	548	DMB MAF audio			adSOUND	
DMB_MAF_Video_Fmt	608	549	DMB MAF video			adMOVIE	
DMP_Content_Fmt	609	550	Digital Media Project Content Format			adMISC	

Format Name	Number	Category	Description	MIME Type	Extension	File Class	Readers
DVB_Fmt	610	551	Digital Video Broadcast format	video/vnd.dvb.file	DVB	adMOVIE	
Dirac_Wavelet_Compression_Fmt	611	552	ISO-BMFF Dirac Wavelet compression			adMISC	
HEICS_Image_Sequence_Fmt	612	553	High Efficiency Image Format HEVC image sequence	image/heic-sequence	HEICS	adRASTERIMAGE	
HEIC_Image_Fmt	613	554	High Efficiency Image Format HEVC image	image/heic	HEIC	adRASTERIMAGE	
HEIFS_Image_Sequence_Fmt	614	555	High Efficiency Image Format image sequence	image/heif-sequence	HEIFS	adRASTERIMAGE	
HEIF_Image_Fmt	615	556	High Efficiency Image Format image	image/heif	HEIF	adRASTERIMAGE	
ISMACryp_Fmt	616	557	ISMACryp 2.0 Encrypted format			adENCAPSULATION	
ISO_3GPP2_Fmt	617	558	3GPP2 video file	video/3gpp2	3G2	adMOVIE	mpeg4sr
ISO_3GPP_Fmt	618	559	3GPP video file	video/3gpp	3GP	adMOVIE	mpeg4sr
ISO_JPEG2000_JP2_Fmt	619	560	ISO-BMFF JPEG 2000 image	image/jp2	JP2	adRASTERIMAGE	jp2000sr , kpjp2000rdr
ISO_JPEG2000_JPM_Fmt	620	561	ISO-BMFF JPEG 2000 compound image	image/jpm	JPM	adRASTERIMAGE	jp2000sr , kpjp2000rdr
ISO_JPEG2000_JPX_Fmt	621	562	ISO-BMFF JPEG 2000 with extensions	image/jpx	JPX	adRASTERIMAGE	jp2000sr , kpjp2000rdr
ISO_QuickTime_Fmt	622	563	Apple ISO-BMFF QuickTime video	video/quicktime	QT, MOV	adMOVIE	MCI
KDDI_Video_Fmt	623	564	KDDI Video file	video/3gpp2		adMOVIE	mpeg4sr
MAF_Photo_Player_Fmt	624	565	MAF Photo Player			adMISC	
MPEG4_AVC_Fmt	625	566	ISO-BMFF MPEG-4 with AVC extension	video/mp4		adMOVIE	mpeg4sr
MPEG4_M4A_Fmt	626	567	Apple MPEG-4 Part 14 audio	audio/x-m4a	M4A	adSOUND	mpeg4sr
MPEG4_M4B_Fmt	627	568	Apple MPEG-4 Part 14 audio book	audio/mp4	M4B	adSOUND	mpeg4sr
MPEG4_M4P_Fmt	628	569	Apple MPEG-4 Part 14 protected audio	audio/mp4	M4P	adSOUND	mpeg4sr

Format Name	Number	Category	Description	MIME Type	Extension	File Class	Readers
MPEG4_M4V_Fmt	629	570	Apple MPEG-4 Part 14 video	video/x-m4v	M4V	adMOVIE	mpeg4sr
MPEG4_Sony_PSP_Fmt	630	571	Sony PSP MPEG-4	audio/mp4	MP4	adSOUND	mpeg4sr
MPEG_21_Fmt	631	572	MPEG-21	audio/mp4		adMISC	mpeg4sr
Mobile_QuickTime_Fmt	632	573	Mobile QuickTime video	video/quicktime	MQV	adMOVIE	MCI
Motion_JPEG_2000_Fmt	633	574	Motion JPEG 2000	video/mj2	MJ2, MJP2	adMOVIE	jp2000sr , kjpj2000rdr
NTT_MPEG4_Fmt	634	575	NTT MPEG-4	video/mp4		adMOVIE	mpeg4sr
Nero_MPEG4_AVC_Profile	635	576	Nero MPEG-4 profile with AVC extension	video/mp4		adMOVIE	
Nero_MPEG4_Audio_Fmt	636	577	Nero AAC audio	audio/mp4		adSOUND	mpeg4sr
Nero_MPEG4_Profile	637	578	Nero MPEG-4 profile	video/mp4		adMOVIE	
OMA_DRM_Fmt	638	579	OMA DRM (ISOBMFF) Format			adMISC	
Panasonic_Camera_Fmt	639	580	Panasonic Digital Camera image			adRASTERIMAGE	
Ross_Video_Fmt	640	581	Ross video			adMOVIE	
SDA_Video_Fmt	641	582	SDA SD Memory Card video			adMOVIE	
Samsung_Stereoscopic_Fmt	642	583	Samsung stereoscopic stream			adMISC	
Sony_XAVC_Fmt	643	584	Sony XAVC video			adMOVIE	mpeg4sr
JPEG_2000_PGX_Fmt	644	585	JPEG 2000 PGX Verification Model image		PGX	adRASTERIMAGE	jp2000sr , kjpj2000rdr
Apple_Desktop_Services_Store_Fmt	645	586	Apple Desktop Services Store file		DS_Store	adMISC	
Core_Audio_Fmt	646	587	Apple Core Audio Format	audio/x-caf	CAF	adSOUND	
VICAR_Fmt	647	588	VICAR image format		IMG	adRASTERIMAGE	
FITS_Fmt	648	589	Flexible Image Transport System FITS image	image/fits	FIT	adRASTERIMAGE	
DIF_Fmt	649	590	Digital Interface Format (DIF) DV video		DV	adMOVIE	
MPEG_Transport_Stream_Fmt	650	591	MPEG Transport Stream data	video/MP2T	TS	adMISC	

Format Name	Number	Category	Description	MIME Type	Extension	File Class	Readers
MPEG_Sequence_Fmt	651	592	MPEG Sequence format	video/mpeg		adMISC	
Ogg_OGM_Fmt	652	593	Ogg OGM video format	video/ogg	OGM	adMOVIE	
Ogg_Speex_Fmt	653	594	Ogg Speex audio format	audio/ogg	SPX	adSOUND	
Ogg_Opus_Fmt	654	595	Ogg Opus audio format	audio/ogg	OGG	adSOUND	
Musepack_Audio_Fmt	655	596	Musepack audio format	audio/x-musepack	MPC	adSOUND	
ART_Image_Fmt	656	597	ART image format		ART	adRASTERIMAGE	
Vivo_Fmt	657	598	Vivo audio-video format	video/vnd.vivo	VIV	adMOVIE	
QCP_Fmt	658	599	Qualcomm QCP audio	audio/qcelp	QCP	adSOUND	
CSP_Codec_Fmt	659	600	Creative Signal Processor codec		CSP	adMISC	
TwinVQ_Fmt	660	601	NTT TwinVQ audio format		VQF	adSOUND	
Interplay_MVE_Fmt	661	602	Interplay MVE video format		MVE	adMOVIE	
IRIX_Moviemaker_Fmt	662	603	IRIX Silicon Graphics moviemaker video file	video/x-sgi-movie	MV, MOVIE	adMOVIE	
Sega_FILM_Fmt	663	604	Sega FILM video format		CPK, CAK	adMOVIE	
SMAF_Fmt	664	605	Synthetic music Mobile Application Format	application/vnd.smaf	MMF	adSOUND	
NIST_SPHERE_Fmt	665	606	NIST SPeech HEader REsources format		NIST	adSOUND	
Chinese_AVS_Fmt	666	607	Chinese AVS video format			adMOVIE	
VQA_Fmt	667	608	Westwood Studios Vector Quantized Animation video file		VQA	adANIMATION	
YAFA_Fmt	668	609	Wildfire YAFA animation		YAFA	adANIMATION	
Origin_MVE_Fmt	669	610	Origin Wing Commander III MVE movie format		MVE	adMOVIE	
BBC_Dirac_Fmt	670	611	BBC Dirac video format	video/x-dirac	DRC	adMOVIE	
Maya_ASCII_Fmt	671	612	Autodesk Maya ASCII file format		MA	adCAD	
RenderMan_Fmt	672	613	Pixar RenderMan Interface Bytestream file		RIB	adVECTORGRAPHIC	
NOFF_Binary_Fmt	673	614	NOFF 3D Object File		NOFF	adVECTORGRAPHIC	

Format Name	Number	Category	Description	MIME Type	Extension	File Class	Readers
			Format				
VTK_ASCII_Fmt	674	615	Visualization Toolkit VTK ASCII format		VTK	adVECTORGRAPHIC	
VTK_Binary_Fmt	675	616	Visualization Toolkit VTK Binary format		VTK	adVECTORGRAPHIC	
Wolfram_CDF_Fmt	676	617	Wolfram Mathematica Computable Document Format	application/cdf	CDF	adMISC	
Wolfram_Notebook_Fmt	677	618	Wolfram Mathematica Notebook Format		NB	adMISC	
HDF4_Fmt	678	619	Hierarchical Data Format HDF4	application/x-hdf	HDF, H4	adMISC	
HDF5_Fmt	679	620	Hierarchical Data Format HDF5	application/x-hdf	HDF, H5	adMISC	
ARMovie_Fmt	680	621	Acorn RISC ARMovie video format		RPL	adMOVIE	
Windows_TV_DVR_Fmt	681	622	Windows Television DVR format		WTV	adMOVIE	
InstallShield_Z_Fmt	682	623	InstallShield Z archive format	application/x-compress	Z	adENCAPSULATION	
MS_DirectDraw_Surface_Fmt	683	624	Microsoft DirectDraw Surface container format		DDS	adENCAPSULATION	
Bink_Fmt	684	625	Bink audio-video container format		BIK, BK2	adMOVIE	
LZMA_Fmt	685	626	LZMA compressed data format	application/x-lzma	LZMA	adENCAPSULATION	
True_Audio_Fmt	686	627	True Audio format	audio/x-tta	TTA	adSOUND	
Keepass_Fmt	687	628	Keepass Password file		KDB, KDBX	adMISC	
RPM_Fmt	688	629	RPM Package Manager file	application/x-rpm	RPM	adENCAPSULATION	
Printer_Font_Metrics_Fmt	689	630	Adobe Printer Font Metrics format	application/x-font-printer-metric	PFM	adFONT	
Adobe_Font_Metrics_Fmt	690	631	Adobe Font Metrics ASCII format	application/x-font-adobe-metric	AFM	adFONT	afmsr
Printer_Font_ASCII_Fmt	691	632	Adobe Printer Font ASCII format	application/x-font-type1	PFA	adFONT	pfasr

Format Name	Number	Category	Description	MIME Type	Extension	File Class	Readers
Netware_Loadable_Module_Fmt	692	633	Netware Loadable Module format		NLM	adMISC	
TCPdump_pcap_Fmt	693	634	TCPdump packet stream capture savefile format	application/vnd.tcpdump.pcap	PCAP	adMISC	
Multiple_Master_Font_Fmt	694	635	Adobe Multiple master font format		MMM	adFONT	
TrueType_Font_Collection_Fmt	695	636	TrueType font collection format	application/x-font-ttf	TTC	adFONT	
Shapefile_Spatial_Index_Fmt	696	637	Shapefile binary spatial index format	application/x-shapefile	SBX, SBN	adGIS	
Java_Key_Store_Fmt	697	638	Java Key Store format	application/x-java-keystore	KS	adMISC	
Java_JCE_Key_Store_Fmt	698	639	Java JCE Key Store format	application/x-java-jce-keystore		adMISC	
Quark_Xpress_Intel_Fmt	699	640	QuarkXPress Intel format	application/vnd.quark.quarkxpress	QXB	adDESKTOPPUBLSH	
Windows_Imaging_Fmt	700	641	Microsoft Windows Imaging Format WIM		WIM	adMISC	
VMware_Virtual_Disk_Fmt	701	642	VMware Virtual Disk Format 5.0	application/x-vmrk	VMDK	adMISC	
XPConnect_Typelib_Fmt	702	643	XPConnect Typelib Format		XPT	adMISC	
MS_DOS_Compression_Fmt	703	644	Microsoft MS-DOS installation compression (SZDD, KWAJ)	application/x-ms-compress	EX_	adENCAPSULATION	
DLS_Fmt	704	645	DLS Downloadable Sounds format		DLS	adSOUND	
MS_Windows_Registry_Fmt	705	646	Microsoft Windows Registry format			adMISC	
Microsoft_Help_2_Fmt	706	647	Microsoft Help 2.0 format	application/x-ms-reader	HXD, HXW, HXH	adENCAPSULATION	
Qt_Translation_Fmt	707	648	Qt binary translation file format		QM	adMISC	
PEM_SSL_Certificate_Fmt	708	649	PEM-encoded SSL certificate	application/pkix-cert	CRT, PEM, CER, KEY	adENCAPSULATION	
PostScript_Printer_Description_Fmt	709	650	Adobe PostScript Printer Description file	application/vnd.cups-ppd	PPD	adMISC	
Speedo_Font_Fmt	710	651	Speedo Font format		SPD	adFONT	

Format Name	Number	Category	Description	MIME Type	Extension	File Class	Readers
InstallShield_Cabinet_Fmt	711	652	InstallShield Cabinet Archive format		CAB, HDR	adENCAPSULATION	
InstallShield_Uninstall_Fmt	712	653	InstallShield Uninstall format		ISU	adENCAPSULATION	
MS_OEDBX_Folder_Fmt	713	654	Outlook Express DBX folder database format		DBX	adENCAPSULATION	
LabVIEW_Fmt	714	655	National Instruments LabVIEW file format		VI	adMISC	
SAP_Archive_SAR_Fmt	715	656	SAP compression archive SAR format		SAR	adENCAPSULATION	
Netscape_Address_Book_Fmt	716	657	Netscape Address Book format		NAB	adMISC	
Universal_3D_Fmt	717	658	Universal 3D file format		U3D	adVECTORGRAPHIC	
Open_Inventor_ASCII_Fmt	718	659	Open Inventor ASCII format		IV	adVECTORGRAPHIC	
Open_Inventor_Binary_Fmt	719	660	Open Inventor Binary format		IV	adVECTORGRAPHIC	
X_Window_Dump_Fmt	720	661	X Window Dump image	image/x-xwindowdump	XWD	adRASTERIMAGE	
Git_Packfile_Fmt	721	662	Git Packfile format		PACK	adENCAPSULATION	
Xara_Xar_Fmt	722	663	Xara X Xar image format	application/vnd.xara	XAR	adVECTORGRAPHIC	
Internet_Archive_ARC_Fmt	723	664	Internet Archive ARC format	application/x-ia-arc	ARC	adENCAPSULATION	
Applix_Builder_Fmt	724	665	Applix Builder format		AB	adMISC	
Applix_Bitmap_Fmt	725	666	Applix Bitmap image format		IM	adRASTERIMAGE	
PEM_RSA_Private_Key_Fmt	726	667	PEM-encoded RSA private key		PEM	adENCAPSULATION	
MIFF_Fmt	727	668	Magick Image File Format		MIFF	adRASTERIMAGE	
Subversion_Dump_Fmt	728	669	Subversion Dump format			adENCAPSULATION	
Virtual_Hard_Disk_Fmt	729	670	Microsoft Virtual Hard Disk format	application/x-vhd	VHD	adENCAPSULATION	
Direct_Access_Archive_Fmt	730	671	PowerISO Direct Access Archive format		DAA	adENCAPSULATION	
Debian_Binary_Fmt	731	672	Debian binary package	application/x-debian-package	DEB	adENCAPSULATION	

Format Name	Number	Category	Description	MIME Type	Extension	File Class	Readers
			format				
XUL_Fastload_Fmt	732	673	Mozilla XUL Fastload format		MFL	adMISC	
Nastran_OP2_Fmt	733	674	Nastran OP2 format		OP2	adCAD	
Binary_Logging_Fmt	734	675	CAD Binary Logging Format		BLF	adCAD	
Measurement_Data_Fmt	735	676	CAD Measurement Data Format		MDF	adCAD	
Abaqus_ODB_Fmt	736	677	Abaqus ODB Format		ODB	adCAD	
Open_Diagnostic_Data_Exchange_Fmt	737	678	Vector Open Diagnostic Data Exchange format		ODX	adCAD	xmlsr
Vector_ASCII_Fmt	738	679	Vector CAD ASCII ASC format		ASC	adCAD	
LSDYNA_State_Database_Fmt	739	680	LS-DYNA State Database format			adCAD	
LSDYNA_Binary_Output_Fmt	740	681	LS-DYNA binary output (binout) format			adCAD	
MS_Power_BI_Fmt	741	682	Microsoft Power BI Desktop format		PBIX	adANALYTICS	pbixsr
Tableau_Workbook_Fmt	742	683	Tableau Workbook format		TWB	adANALYTICS	xmlsr
Tableau_Packaged_Workbook_Fmt	743	684	Tableau Packaged Workbook format		TWBX	adANALYTICS	unzip
Tableau_Extract_Fmt	744	685	Tableau Extract format		TDE	adANALYTICS	
Tableau_Data_Source_Fmt	745	686	Tableau Data Source format		TDS	adANALYTICS	xmlsr
Tableau_Packaged_Data_Source_Fmt	746	687	Tableau Packaged Data Source format		TDSX	adANALYTICS	unzip
Tableau_Preferences_Fmt	747	688	Tableau Preferences format		TPS	adANALYTICS	xmlsr
Tableau_Map_Source_Fmt	748	689	Tableau Map Source format		TMS	adANALYTICS	xmlsr
ABAP_Fmt	749	690	ABAP Source Code ⁴	text/x-abap	ABAP	adSOURCECODE	afsr
AMPL_Fmt	750	691	AMPL Source Code ⁴		AMPL	adSOURCECODE	afsr
APL_Fmt	751	692	APL Source Code ⁴		APL	adSOURCECODE	afsr

Format Name	Number	Category	Description	MIME Type	Extension	File Class	Readers
ASN1_Fmt	752	693	ASN.1 Source Code ⁴		ASN	adSOURCECODE	afsr
ATS_Fmt	753	694	ATS Source Code ⁴			adSOURCECODE	afsr
Agda_Fmt	754	695	Agda Source Code ⁴	text/x-agda	AGDA	adSOURCECODE	afsr
Alloy_Fmt	755	696	Alloy Source Code ⁴	text/x-alloy	ALS	adSOURCECODE	afsr
Apex_Fmt	756	697	Apex Source Code ⁴		CLS	adSOURCECODE	afsr
Arduino_Fmt	757	698	Arduino Source Code ⁴	text/x-arduino	INO	adSOURCECODE	afsr
AsciiDoc_Fmt	758	699	AsciiDoc Source Code ⁴	text/x-asciidoc	ASC	adSOURCECODE	afsr
AspectJ_Fmt	759	700	AspectJ Source Code ⁴	text/x-aspectj	AJ	adSOURCECODE	afsr
Awk_Fmt	760	701	Awk Source Code ⁴	text/x-awk	AWK	adSOURCECODE	afsr
BlitzMax_Fmt	761	702	BlitzMax Source Code ⁴	text/x-bmx	BMX	adSOURCECODE	afsr
Bluespec_Fmt	762	703	Bluespec Source Code ⁴		BSV	adSOURCECODE	afsr
Brainfuck_Fmt	763	704	Brainfuck Source Code ⁴	text/x-brainfuck	B, BF	adSOURCECODE	afsr
Brightscript_Fmt	764	705	Brightscript Source Code ⁴		BRS	adSOURCECODE	afsr
CLIPS_Fmt	765	706	CLIPS Source Code ⁴		CLP	adSOURCECODE	afsr
CMake_Fmt	766	707	CMake Source Code ⁴	text/x-cmake	CMAKE	adSOURCECODE	afsr
COBOL_Fmt	767	708	COBOL Source Code ⁴	text/x-cobol	CBL, CCP, COB, CPY	adSOURCECODE	afsr
CWeb_Fmt	768	709	CWeb Source Code ⁴		W	adSOURCECODE	afsr
CartoCSS_Fmt	769	710	CartoCSS Source Code ⁴		MSS	adSOURCECODE	afsr
Ceylon_Fmt	770	711	Ceylon Source Code ⁴	text/x-ceylon	CEYLON	adSOURCECODE	afsr
Chapel_Fmt	771	712	Chapel Source Code ⁴		CHPL	adSOURCECODE	afsr
Clarion_Fmt	772	713	Clarion Source Code ⁴		CLW	adSOURCECODE	afsr
Clean_Fmt	773	714	Clean Source Code ⁴		DCL, ICL	adSOURCECODE	afsr
Component_Pascal_Fmt	774	715	Component Pascal Source Code ⁴	text/x-component-pascal	CP	adSOURCECODE	afsr
Cool_Fmt	775	716	Cool Source Code ⁴		CL	adSOURCECODE	afsr
Coq_Fmt	776	717	Coq Source Code ⁴	text/x-coq	V	adSOURCECODE	afsr
Creole_Fmt	777	718	Creole Source Code ⁴		CREOLE	adSOURCECODE	afsr
Crystal_Fmt	778	719	Crystal Source Code ⁴		CR	adSOURCECODE	afsr
Csound_Fmt	779	720	Csound Source Code ⁴		ORC	adSOURCECODE	afsr

Format Name	Number	Category	Description	MIME Type	Extension	File Class	Readers
Csound_Document_Fmt	780	721	Csound Document Source Code ⁴		CSD	adSOURCECODE	afsr
Cuda_Fmt	781	722	Cuda Source Code ⁴	text/x-cuda	CU	adSOURCECODE	afsr
D_Fmt	782	723	D Source Code ⁴	text/x-d	DCL, ICL	adSOURCECODE	afsr
DIGITAL_Command_Language_Fmt	783	724	DIGITAL Command Language Source Code ⁴		COM	adSOURCECODE	afsr
DTrace_Fmt	784	725	DTrace Source Code ⁴		D	adSOURCECODE	afsr
Dart_Fmt	785	726	Dart Source Code ⁴	text/x-dart	DART	adSOURCECODE	afsr
E_Fmt	786	727	E Source Code ⁴		E	adSOURCECODE	afsr
ECL_Fmt	787	728	ECL Source Code ⁴	application/x-ecl	ECL	adSOURCECODE	afsr
Elm_Fmt	788	729	Elm Source Code ⁴	text/x-elm	ELM	adSOURCECODE	afsr
Emacs_Lisp_Fmt	789	730	Emacs Lisp Source Code ⁴	text/x-emacs-lisp	EL	adSOURCECODE	afsr
EmberScript_Fmt	790	731	EmberScript Source Code ⁴		EM	adSOURCECODE	afsr
Fantom_Fmt	791	732	Fantom Source Code ⁴	application/x-fantom	FAN	adSOURCECODE	afsr
Forth_Fmt	792	733	Forth Source Code ⁴	text/x-forth	FOR, FORTH	adSOURCECODE	afsr
FreeMarker_Fmt	793	734	FreeMarker Source Code ⁴		FTL	adSOURCECODE	afsr
Frege_Fmt	794	735	Frege Source Code ⁴		FR	adSOURCECODE	afsr
G_code_Fmt	795	736	G-code Source Code ⁴		G	adSOURCECODE	afsr
GAMS_Fmt	796	737	GAMS Source Code ⁴		GMS	adSOURCECODE	afsr
GAP_Fmt	797	738	GAP Source Code ⁴			adSOURCECODE	afsr
GDScript_Fmt	798	739	GDScript Source Code ⁴		GD	adSOURCECODE	afsr
GLSL_Fmt	799	740	GLSL Source Code ⁴	text/x-glslsrc	GLSL	adSOURCECODE	afsr
Game_Maker_Language_Fmt	800	741	Game Maker Language Source Code ⁴		GML	adSOURCECODE	afsr
Gnuplot_Fmt	801	742	Gnuplot Source Code ⁴	text/x-gnuplot	GNU, GP	adSOURCECODE	afsr
Golo_Fmt	802	743	Golo Source Code ⁴		GOLO	adSOURCECODE	afsr
Gosu_Fmt	803	744	Gosu Source Code ⁴	text/x-gosu	GS	adSOURCECODE	afsr
Gradle_Fmt	804	745	Gradle Source Code ⁴		GRADLE	adSOURCECODE	afsr
GraphQL_Fmt	805	746	GraphQL Source Code ⁴		GRAPHQL	adSOURCECODE	afsr
Graphviz_DOT_Fmt	806	747	Graphviz (DOT) Source		DOT	adSOURCECODE	afsr

Format Name	Number	Category	Description	MIME Type	Extension	File Class	Readers
			Code ⁴				
HLSL_Fmt	807	748	HLSL Source Code ⁴		HLSL	adSOURCECODE	afsr
Hack_Fmt	808	749	Hack Source Code ⁴			adSOURCECODE	afsr
HamI_Fmt	809	750	HamI Source Code ⁴	text/x-haml	HAML	adSOURCECODE	afsr
Handlebars_Fmt	810	751	Handlebars Source Code ⁴		HBS	adSOURCECODE	afsr
Hy_Fmt	811	752	Hy Source Code ⁴	text/x-hy	HY	adSOURCECODE	afsr
IDL_Fmt	812	753	IDL Source Code ⁴	text/x-idl	PRO	adSOURCECODE	afsr
IGOR_Pro_Fmt	813	754	IGOR Pro Source Code ⁴	text/ipf	IPF	adSOURCECODE	afsr
Idris_Fmt	814	755	Idris Source Code ⁴	text/x-idris	IDR	adSOURCECODE	afsr
Inform_7_Fmt	815	756	Inform 7 Source Code ⁴		I7X	adSOURCECODE	afsr
Ioke_Fmt	816	757	Ioke Source Code ⁴	text/x-iokesrc	IK	adSOURCECODE	afsr
Isabelle_Fmt	817	758	Isabelle Source Code ⁴	text/x-isabelle		adSOURCECODE	afsr
J_Fmt	818	759	J Source Code ⁴	text/x-j	IJS	adSOURCECODE	afsr
JSONiq_Fmt	819	760	JSONiq Source Code ⁴		JQ	adSOURCECODE	afsr
JSX_Fmt	820	761	JSX Source Code ⁴		JSX	adSOURCECODE	afsr
Jasmin_Fmt	821	762	Jasmin Source Code ⁴		J	adSOURCECODE	afsr
Jolie_Fmt	822	763	Jolie Source Code ⁴			adSOURCECODE	afsr
Julia_Fmt	823	764	Julia Source Code ⁴	text/x-julia	JL	adSOURCECODE	afsr
KiCad_Layout_Fmt	824	765	KiCad Layout Source Code ⁴			adSOURCECODE	afsr
KiCad_Schematic_Fmt	825	766	KiCad Schematic Source Code ⁴		SCH	adSOURCECODE	afsr
Kotlin_Fmt	826	767	Kotlin Source Code ⁴		KT	adSOURCECODE	afsr
LFE_Fmt	827	768	LFE Source Code ⁴	text/x-kotlin	LFE	adSOURCECODE	afsr
LOLCODE_Fmt	828	769	LOLCODE Source Code ⁴		LOL	adSOURCECODE	afsr
Lasso_Fmt	829	770	Lasso Source Code ⁴	text/x-lasso	LAS, LASSO	adSOURCECODE	afsr
Limbo_Fmt	830	771	Limbo Source Code ⁴	text/limbo		adSOURCECODE	afsr
LiveScript_Fmt	831	772	LiveScript Source Code ⁴	text/x-livescript	LS	adSOURCECODE	afsr
M_Fmt	832	773	M Source Code ⁴		M	adSOURCECODE	afsr
MAXScript_Fmt	833	774	MAXScript Source Code ⁴		MS	adSOURCECODE	afsr

Format Name	Number	Category	Description	MIME Type	Extension	File Class	Readers
Markdown_Fmt	834	775	Markdown Source Code ⁴		MD	adSOURCECODE	afsr
Matlab_Fmt	835	463	Matlab Source Code ⁴	text/x-matlab	M	adSOURCECODE	afsr
Max_Code_Fmt	836	776	Max Source Code ⁴		MXT	adSOURCECODE	afsr
Mercury_Fmt	837	777	Mercury Source Code ⁴			adSOURCECODE	afsr
Modelica_Fmt	838	778	Modelica Source Code ⁴	text/x-modelica	MO	adSOURCECODE	afsr
Modula_2_Fmt	839	779	Modula-2 Source Code ⁴	text/x-modula2	MOD	adSOURCECODE	afsr
Monkey_Fmt	840	780	Monkey Source Code ⁴	text/x-monkey	MONKEY	adSOURCECODE	afsr
Moocode_Fmt	841	781	Moocode Source Code ⁴	text/x-moocode	MOO	adSOURCECODE	afsr
NL_Fmt	842	782	NL Source Code ⁴		NL	adSOURCECODE	afsr
NSIS_Fmt	843	783	NSIS Source Code ⁴	text/x-nsis	NSI	adSOURCECODE	afsr
NetLogo_Fmt	844	784	NetLogo Source Code ⁴		NLOGO	adSOURCECODE	afsr
NewLisp_Fmt	845	785	NewLisp Source Code ⁴	text/x-newlisp	NL	adSOURCECODE	afsr
Nginx_Fmt	846	786	Nginx Source Code ⁴	text/x-nginx-conf	VHOST	adSOURCECODE	afsr
Nix_Fmt	847	787	Nix Source Code ⁴	text/x-nix	NIX	adSOURCECODE	afsr
Nu_Fmt	848	788	Nu Source Code ⁴		NU	adSOURCECODE	afsr
OCaml_Fmt	849	789	OCaml Source Code ⁴	text/x-ocaml		adSOURCECODE	afsr
OpenCL_Fmt	850	790	OpenCL Source Code ⁴		CL	adSOURCECODE	afsr
OpenEdge_ABL_Fmt	851	791	OpenEdge ABL Source Code ⁴	text/x-openedge		adSOURCECODE	afsr
OpenSCAD_Fmt	852	792	OpenSCAD Source Code ⁴		SCAD	adSOURCECODE	afsr
Ox_Fmt	853	793	Ox Source Code ⁴		OX	adSOURCECODE	afsr
Oxygene_Fmt	854	794	Oxygene Source Code ⁴		OXYGENE	adSOURCECODE	afsr
Oz_Fmt	855	795	Oz Source Code ⁴		OZ	adSOURCECODE	afsr
PAWN_Fmt	856	796	PAWN Source Code ⁴	text/x-pawn	PWN	adSOURCECODE	afsr
PLpgSQL_Fmt	857	797	PLpgSQL Source Code ⁴	text/x-plpgsql	PLSQL	adSOURCECODE	afsr
Pan_Fmt	858	798	Pan Source Code ⁴		PAN	adSOURCECODE	afsr
Parrot_Assembly_Fmt	859	799	Parrot Assembly Source Code ⁴		PASM	adSOURCECODE	afsr
PicoLisp_Fmt	860	800	PicoLisp Source Code ⁴			adSOURCECODE	afsr
Pike_Fmt	861	801	Pike Source Code ⁴	text/x-pike	PIKE	adSOURCECODE	afsr

Format Name	Number	Category	Description	MIME Type	Extension	File Class	Readers
Pony_Fmt	862	802	Pony Source Code ⁴		PONY	adSOURCECODE	afsr
Processing_Fmt	863	803	Processing Source Code ⁴		PDE	adSOURCECODE	afsr
PureBasic_Fmt	864	804	PureBasic Source Code ⁴		PB	adSOURCECODE	afsr
QMake_Fmt	865	805	QMake File ⁴			adSOURCECODE	afsr
RAML_Fmt	866	806	RAML Source Code ⁴		RAML	adSOURCECODE	afsr
RDoc_Fmt	867	807	RDoc Source Code ⁴		RDOC	adSOURCECODE	afsr
REXX_Fmt	868	808	REXX Source Code ⁴	text/x-rexx	REXX	adSOURCECODE	afsr
Racket_Fmt	869	809	Racket Source Code ⁴	text/x-racket		adSOURCECODE	afsr
Ragel_Fmt	870	810	Ragel Source Code ⁴			adSOURCECODE	afsr
Rascal_Fmt	871	811	Rascal Source Code ⁴		RSC	adSOURCECODE	afsr
Rebol_Fmt	872	812	Rebol Source Code ⁴	text/x-rebol	REB, REBOL	adSOURCECODE	afsr
Red_Fmt	873	813	Red Source Code ⁴	text/x-red	RED	adSOURCECODE	afsr
RenPy_Fmt	874	814	Ren'Py Source Code ⁴		RPY	adSOURCECODE	afsr
RenderScript_Fmt	875	815	RenderScript Source Code ⁴		RS	adSOURCECODE	afsr
Ring_Fmt	876	816	Ring Source Code ⁴		RING	adSOURCECODE	afsr
RobotFramework_Fmt	877	817	RobotFramework Source Code ⁴	text/x-robotframework	ROBOT	adSOURCECODE	afsr
SAS_Fmt	878	818	SAS Source Code ⁴		SAS	adSOURCECODE	afsr
SPARQL_Fmt	879	819	SPARQL format ⁴	application/sparql-query		adSOURCECODE	afsr
SQL_Fmt	880	820	SQL format ⁴	text/x-sql		adSOURCECODE	afsr
SQLPL_Fmt	881	821	SQLPL Source Code ⁴			adSOURCECODE	afsr
SaltStack_Fmt	882	822	SaltStack Source Code ⁴		SLS	adSOURCECODE	afsr
Scheme_Fmt	883	823	Scheme Source Code ⁴	text/x-scheme		adSOURCECODE	afsr
Scilab_Fmt	884	824	Scilab Source Code ⁴	text/scilab	SCI	adSOURCECODE	afsr
Squirrel_Fmt	885	825	Squirrel Source Code ⁴		NUT	adSOURCECODE	afsr
Stan_Fmt	886	826	Stan Source Code ⁴		STAN	adSOURCECODE	afsr
Stata_Fmt	887	827	Stata Source Code ⁴			adSOURCECODE	afsr
Stylus_Fmt	888	828	Stylus Source Code ⁴		STYL	adSOURCECODE	afsr

Format Name	Number	Category	Description	MIME Type	Extension	File Class	Readers
SuperCollider_Fmt	889	829	SuperCollider Source Code ⁴	text/supercollider	SC	adSOURCECODE	afsr
SystemVerilog_Fmt	890	830	SystemVerilog Source Code ⁴	text/x-systemverilog	SV	adSOURCECODE	afsr
TXL_Fmt	891	831	TXL Source Code ⁴		TXL	adSOURCECODE	afsr
Turing_Fmt	892	832	Turing Source Code ⁴		T	adSOURCECODE	afsr
Turtle_Fmt	893	833	Turtle Source Code ⁴	text/turtle	TTL	adSOURCECODE	afsr
UrWeb_Fmt	894	834	UrWeb Source Code ⁴		UR, URS	adSOURCECODE	afsr
Vim_script_Fmt	895	835	Vim script File ⁴	text/x-vim	VIM	adSOURCECODE	afsr
Visual_Basic_Fmt	896	836	Visual Basic Source Code ⁴	text/x-vbasic	VB	adSOURCECODE	afsr
WebAssembly_Fmt	897	837	WebAssembly Source Code ⁴		WAT	adSOURCECODE	afsr
WebIDL_Fmt	898	838	WebIDL Source Code ⁴		WEBIDL	adSOURCECODE	afsr
X10_Fmt	899	839	X10 Source Code ⁴	text/x-x10	X10	adSOURCECODE	afsr
XQuery_Fmt	900	840	XQuery Source Code ⁴	text/xquery	XQM	adSOURCECODE	afsr
Xojo_Fmt	901	841	Xojo Source Code ⁴			adSOURCECODE	afsr
Xtend_Fmt	902	842	Xtend Source Code ⁴	text/x-xtend	XTEND	adSOURCECODE	afsr
YANG_Fmt	903	843	YANG Source Code ⁴		YANG	adSOURCECODE	afsr
Zephir_Fmt	904	844	Zephir Source Code ⁴		ZEP	adSOURCECODE	afsr
eC_Fmt	905	845	eC Source Code ⁴	text/x-ecsrc	EC	adSOURCECODE	afsr
reStructuredText_Fmt	906	846	reStructuredText Source Code ⁴	text/x-rst		adSOURCECODE	afsr
xBase_Fmt	907	847	xBase Source Code ⁴			adSOURCECODE	afsr
Windows_Installer_Fmt	908	848	MSI Windows Installer format	application/x-ole-storage	MSI	adENCAPSULATION	olesr
Autodesk_3ds_Max_Fmt	909	849	Autodesk 3ds Max format		MAX	adCAD	olesr
PhotoDraw_Mix_Fmt	910	850	PhotoDraw MIX image	image/vnd.mix	MIX	adRASTERIMAGE	olesr
Softimage_SCN_Fmt	911	851	Softimage Scene SCN format		SCN	adCAD	
Parasolid_XT_Fmt	912	852	Parasolid ascii XT format		X_T	adCAD	
Parasolid_XB_Fmt	913	853	Parasolid binary XB format		X_B	adCAD	

Format Name	Number	Category	Description	MIME Type	Extension	File Class	Readers
IGES_Fmt	914	854	Initial Graphics Exchange Specification format	model/iges	IGS	adCAD	
ACE_Archive_Fmt	915	855	ACE archive format	application/x-ace-compressed	ACE	adENCAPSULATION	
Grasshopper_GHX_Fmt	916	856	Grasshopper GHX format		GHX	adCAD	xmlsr
MS_FrontPage_Macro_Fmt	917	857	Microsoft FrontPage macro file format		FPM	adWORDPROCESSOR	
MS_AtWork_Fax_Fmt	918	858	Microsoft AtWork Fax format		AWD	adFAXFORMAT	olesr
MS_Image_Composer_Fmt	919	859	Microsoft Image Composer format		MIC	adRASTERIMAGE	
MS_Visual_InterDev_Fmt	920	860	Microsoft Visual InterDev web project items file		WDM	adMISC	
Macromedia_Flash_FLA_OLE_Fmt	921	861	Macromedia Flash FLA Project File OLE format		FLA	adWORDPROCESSOR	
Corel_Draw_X4_Fmt	922	862	CorelDRAW version X4 onwards	application/x-vnd.corel.zcf.draw.document+zip	CDRX	adVECTORGRAPHIC	
Ogg_Daala_Fmt	923	863	Ogg Daala video format	video/daala	OGV	adMOVIE	
Ogg_BBC_Dirac_Fmt	924	864	Ogg BBC Dirac video format	video/x-dirac	OGV	adMOVIE	
PKCS_7_Fmt	925	865	PKCS #7 cryptographic format	application/pkcs7-signature	P7S	adENCAPSULATION	pkcs7sr
Time_Stamped_Data_Fmt	926	866	Time-stamped data format	application/timestamped-data	TSD	adENCAPSULATION	
Sereal_Fmt	927	867	Sereal data serialization format	application/sereal	SRL	adMISC	
Associated_Signature_Simple_Fmt	928	868	Associated Signature Container Simple format	application/vnd.etsi.asic-s+zip	ASICS	adENCAPSULATION	
Associated_Signature_Extended_Fmt	929	869	Associated Signature Container Extended format	application/vnd.etsi.asic-e+zip	ASICE	adENCAPSULATION	
iBooks_Fmt	930	870	Apple iBooks format	application/x-ibooks+zip	IBOOKS	adWORDPROCESSOR	epubsr
PDF_Forms_Data_Fmt	931	871	PDF Forms Data Format	application/vnd.fdf	FDF	adWORDPROCESSOR	
PDF_XML_Forms_Data_Fmt	932	872	PDF XML Forms Data Format	application/vnd.adobe.xfdf	XPDF	adWORDPROCESSOR	xmlsr
AxCrypt_Fmt	933	873	AxCrypt encrypted document	application/x-axcrypt	AXX	adENCAPSULATION	

Format Name	Number	Category	Description	MIME Type	Extension	File Class	Readers
Unix_Archive_Fmt	934	874	Unix Archive ar format	application/x-archive	AR	adENCAPSULATION	
Berkeley_Btree_Database_Fmt	935	875	Berkeley DB btree database format	application/x-berkeley-db	DB	adDATABASE	
Berkeley_Hash_Database_Fmt	936	876	Berkeley DB hash database format	application/x-berkeley-db	DB	adDATABASE	
Berkeley_Log_Database_Fmt	937	877	Berkeley DB log database format	application/x-berkeley-db		adDATABASE	
Berkeley_Queue_Database_Fmt	938	878	Berkeley DB queue database format	application/x-berkeley-db		adDATABASE	
BitTorrent_Fmt	939	879	BitTorrent file format	application/x-bittorrent	TORRENT	adMISC	
Chrome_Extension_Fmt	940	880	Google Chrome Extension format	application/x-chrome-package	CRX	adENCAPSULATION	
Dalvik_Executable_Fmt	941	881	Dalvik Executable dex format	application/x-dex	DEX	adEXECUTABLE	
Foxmail_Fmt	942	882	Foxmail email format	application/x-foxmail	BOX	adWORDPROCESSOR	
GRIB_Fmt	943	883	General Regularly-distributed Information in Binary form GRIB format	application/x-grib	GRB, GRIB2	adMISC	
Zstandard_Fmt	944	884	Zstandard compression format	application/zstd	ZSTD	adENCAPSULATION	
LZ4_Fmt	945	885	LZ4 compressed file	application/x-lz4	LZ4	adENCAPSULATION	
MS_Money_Fmt	946	886	Microsoft Money format	application/x-msmoney	MNY	adSPREADSHEET	
NetCDF_Fmt	947	887	Network Common Data Form NetCDF format	application/x-netcdf	NC	adMISC	
SAS6_Data_Fmt	948	888	SAS 6 Data storage format	application/x-sas-data-v6	SD2	adDATABASE	
SAS_Transport_Fmt	949	889	SAS Transport File XPORT format	application/x-sas-xport	XPT, XPORT	adDATABASE	
Snappy_Framed_Fmt	950	890	Snappy Framed compression format	application/x-snappy-framed	SZ	adENCAPSULATION	
Stata_Data_Fmt	951	891	Stata Data Format	application/x-stata-dta	DTA	adDATABASE	
SPSS_SAV_Fmt	952	892	SPSS Statistics Data File Format		SAV	adDATABASE	
Zoo_Archive_Fmt	953	893	Zoo Compressed Archive Format	application/x-zoo	ZOO	adENCAPSULATION	

Format Name	Number	Category	Description	MIME Type	Extension	File Class	Readers
CDX_Fmt	954	894	ChemDraw CDX format	chemical/x-cdx	CDX	adSCIENTIFIC	
CDXML_Fmt	955	895	ChemDraw CDXML format	application/vnd.chemdraw+xml	CDXML	adSCIENTIFIC	xmlsr
BPG_Fmt	956	896	Better Portable Graphics BPG format	image/x-bpg	BPG	adRASTERIMAGE	
Apple_Icon_Fmt	957	897	Apple Icon image format	image/icns	ICNS	adRASTERIMAGE	
NITF_Fmt	958	898	National Imagery Transmission Format NITF image	image/nitf	NTF, NITF	adRASTERIMAGE	
ERDAS_Imagine_Fmt	959	899	ERDAS Imagine image format	application/x-erdas-hfa	HFA, RRD, AUX	adRASTERIMAGE	
MS_Office_Temporary_Owner_Fmt	960	900	Microsoft Office temporary owner file	application/x-ms-owner		adMISC	
EAC3_Audio_Fmt	961	901	Enhanced-AC3 (EAC3) Audio File format	audio/eac3	AC3	adSOUND	
COFF_Relocatable_Fmt	962	902	Common Object File Format (COFF) relocatable object	application/x-object-file	O	adOBJECTMODULE	
COFF_Executable_Fmt	963	903	Common Object File Format (COFF) executable	application/x-executable-file		adEXECUTABLE	
COFF_Dynamic_Lib_Fmt	964	904	Common Object File Format (COFF) dynamic library	application/x-library-file		adLIBRARY	
ELF_Core_Fmt	965	905	ELF Core file	application/x-core dump		adMISC	
Purify_Fmt	966	906	Rational Purify data file		PFY	adMISC	
Kryptel_Fmt	967	907	Kryptel encrypted file		EDC	adENCAPSULATION	
Windows_Core_Dump_Fmt	968	908	Windows heap or mini core dump file	application/x-dmp	DMP	adMISC	
Qt_Prerendered_Font_Fmt	969	909	Qt Prerendered Font format		QPF2	adFONT	
AIX_Relocatable_Fmt	970	910	AIX/RISC COFF relocatable object	application/x-object-file		adOBJECTMODULE	
AIX_Executable_Fmt	971	911	AIX/RISC COFF executable	application/x-executable-file		adEXECUTABLE	

Format Name	Number	Category	Description	MIME Type	Extension	File Class	Readers
AIX_Dynamic_Lib_Fmt	972	912	AIX/RISC COFF dynamic library	application/x-library-file	A	adLIBRARY	
HPUX_Relocatable_Fmt	973	913	HPUX/PA-RISC COFF relocatable object	application/x-object-file		adOBJECTMODULE	
HPUX_Executable_Fmt	974	914	HPUX/PA-RISC COFF executable	application/x-executable-file		adEXECUTABLE	
HPUX_Dynamic_Lib_Fmt	975	915	HPUX/PA-RISC COFF dynamic library	application/x-library-file	SL	adLIBRARY	
XML_EBCDIC_Fmt	976	916	EBCDIC-encoded XML file	application/xml	XML	adWORDPROCESSOR	
MPEG_JVT_H264_Fmt	977	917	MPEG JVT-NAL sequence H264 video	video/h264	264	adMOVIE	
Material_Exchange_Fmt	978	918	Material Exchange Format audio-video container format	application/mxf	MXF	adMOVIE	
MS_Agent_Character_Fmt	979	919	Microsoft Agent Character file		ACS	adMOVIE	
Quicken_Fmt	980	920	Quicken data file		QDF	adMISC	
MS_Outlook_Address_Fmt	981	921	Microsoft Outlook address file		WAB	adMISC	
MS_Answer_Wizard_Fmt	982	922	Microsoft Answer Wizard file			adMISC	
ADX_Fmt	983	923	ADX audio file		ADX	adSOUND	
System_Deployment_Image_Fmt	984	924	Microsoft System Deployment Image SDI format		SDI	adMISC	
Free_Lossless_Image_Fmt	985	925	Free Lossless Image Format (FLIF)	image/flif	FLIF	adRASTERIMAGE	
DPX_Fmt	986	926	Digital Picture Exchange (DPX) image format	image/dpx	DPX	adRASTERIMAGE	
Avro_Fmt	987	927	Apache Avro binary format		AVRO	adMISC	avrosr
InstallShield_Archive_Fmt	988	928	InstallShield archive (early versions) format		EX_	adENCAPSULATION	
Mac_Executable_Fmt	989	929	Mac OS-X (Mach-O) executable format			adEXECUTABLE	
GDSII_Fmt	990	930	GDSII data format		GDS, GDS2	adCAD	gdsiisr

Format Name	Number	Category	Description	MIME Type	Extension	File Class	Readers
ActiveMime_Fmt	991	931	Microsoft ActiveMime (mso) documents	application/x-mso	MSO	adMISC	
SmartCharts_Fmt	992	932	BizInt SmartCharts data format		CHP, CHRR	adMISC	
Webex_ARF_Fmt	993	933	Webex advanced network ARF recordings		ARF	adMOVIE	
Webex_WRF_Fmt	994	934	Webex local WRF recordings		WRF	adMOVIE	
PGP_NetShare_Fmt	995	935	Symantec PGP NetShare encrypted file			adENCAPSULATION	
Ability_WP_OLE_Fmt	996	936	Ability Write later versions format		AWW	adWORDPROCESSOR	olesr
Ability_SS_OLE_Fmt	997	937	Ability Spreadsheet later versions format		AWS	adSPREADSHEET	
InDesign_IDML_Fmt	998	938	Adobe InDesign IDML format	application/vnd.adobe.indesign-idml-package	IDML	adDESKTOPPUBLSH	
Executable_JAR_Fmt	999	939	Executable Java Archive (jar) file	application/java-archive	JAR	adENCAPSULATION	unzip
IDOL_IDX_Fmt	1000	940	IDOL Server IDX file		IDX	adENCAPSULATION	
Android_Package_Kit_Fmt	1001	941	Android Package Kit (APK) format	application/vnd.android.package-archive	APK	adEXECUTABLE	
Android_Binary_XML_Fmt	1002	942	Android Binary XML (compressed by aapt) format	application/xml	XML	adWORDPROCESSOR	
Java_WAR_Fmt	1003	943	Java WAR file format		WAR	adENCAPSULATION	
Java_EAR_Fmt	1004	944	Java EAR file format		EAR	adENCAPSULATION	
Atom_Syndication_Fmt	1005	945	Atom Syndication Format	application/atom+xml	ATOM	adWORDPROCESSOR	xmlsr
RSS_Fmt	1006	946	RSS syndication XML format	application/rss+xml	RSS	adWORDPROCESSOR	xmlsr
SMIL_Fmt	1007	947	Synchronized Multimedia Integration Language (SMIL) XML format	application/smil+xml	SMIL	adWORDPROCESSOR	xmlsr
XSLT_Fmt	1008	948	Extensible Stylesheet Language Transformations (XSLT) format	application/xslt+xml	XSL, XSLT	adWORDPROCESSOR	xmlsr

Format Name	Number	Category	Description	MIME Type	Extension	File Class	Readers
XML_Shareable_Playlist_Fmt	1009	949	XML Shareable Playlist Format (XSPF)	application/xspf+xml	XSPF	adWORDPROCESSOR	xmlsr
FictionBook_Fmt	1010	950	FictionBook e-book XML format	application/x-fictionbook+xml	FB2	adWORDPROCESSOR	xmlsr
Adobe_Premiere_Project_Fmt	1011	951	Adobe Premiere project format	image/vnd.adobe.premiere	PPJ	adMISC	
RDF_XML_Fmt	1012	952	RDF/XML format	application/rdf+xml	RDF	adWORDPROCESSOR	xmlsr
Really_Simple_Discovery_Fmt	1013	953	Really Simple Discovery (RSD) XML format	application/rsd+xml	RSD	adWORDPROCESSOR	xmlsr
SBML_Fmt	1014	954	Systems Biology Markup Language (SBML) XML format	application/sbml+xml	SBML	adWORDPROCESSOR	xmlsr
SRU_Fmt	1015	955	Search/Retrieve via URL (SRU) XML format	application/sru+xml	SRU	adWORDPROCESSOR	xmlsr
SSML_Fmt	1016	956	Speech Synthesis Markup Language (SSML) XML format	application/ssml+xml	SSML	adWORDPROCESSOR	xmlsr
PLS_Fmt	1017	957	Pronunciation Lexicon Specification (PLS) XML format	application/pls+xml	PLS	adWORDPROCESSOR	xmlsr
TEI_Fmt	1018	958	Text Encoding Initiative (TEI) XML format	application/tei+xml	TEI	adWORDPROCESSOR	xmlsr
METS_Fmt	1019	959	Metadata Encoding and Transmission Standard (METS) XML format	application/mets+xml	METS	adWORDPROCESSOR	xmlsr
MODS_Fmt	1020	960	Metadata Object Description Schema (MODS) XML format	application/mods+xml	MODS	adWORDPROCESSOR	xmlsr
Metalink_Fmt	1021	961	Metalink XML format	application/metalink4+xml	METALINK	adWORDPROCESSOR	xmlsr
Open_eBook_Fmt	1022	962	Open eBook (OEBPS) XML format	application/oebps-package+xml	OPF	adWORDPROCESSOR	xmlsr
SRGS_Fmt	1023	963	Speech Recognition Grammar Specification (SRGS) XML format	application/srgs+xml	SRGS	adWORDPROCESSOR	xmlsr
SPARQL_Results_Fmt	1024	964	SPARQL Query Results XML format	application/sparql-results+xml	SRX	adWORDPROCESSOR	xmlsr
Adobe_XML_Data_	1025	965	Adobe XML Data Package	application/vnd.adobe.xdp+xml	XDP	adWORDPROCESSOR	xmlsr

Format Name	Number	Category	Description	MIME Type	Extension	File Class	Readers
Package_Fmt			format				
ESzigno_Fmt	1026	966	e-Szigno signed xml document	application/vnd.eszigno3+xml	ES3	adWORDPROCESSOR	xmlsr
Mozilla_XUL_Fmt	1027	967	Mozilla XML User Interface Language (XUL) XML format	application/vnd.mozilla.xul+xml	XUL	adWORDPROCESSOR	xmlsr
SyncML_Fmt	1028	968	Synchronization Markup Language (SyncML) XML format	application/vnd.syncml+xml	XML	adWORDPROCESSOR	xmlsr
VoiceXML_Fmt	1029	969	VoiceXML (VXML) XML format	application/voicexml+xml	VXML	adWORDPROCESSOR	xmlsr
TI_Target_Configuration_Fmt	1030	970	Texas Instruments CCXML target configuration XML format		CCXML	adWORDPROCESSOR	
LZFSE_Fmt	1031	971	Lempel-Ziv Finite State Entropy (LZFSE) compression format		LZFSE	adENCAPSULATION	
Kindle_eBook_Fmt	1032	972	Amazon Kindle or Mobipocket eBook format	application/vnd.amazon.ebook	AZW, PRC	adWORDPROCESSOR	
Oasis_Stream_Fmt	1033	973	Open Artwork System Interchange Standard (OASIS) format		OAS	adMISC	
Amazon_KFX_Fmt	1034	974	Amazon KFX eBook format		KFX	adWORDPROCESSOR	
KTX_Fmt	1035	975	KTX image format	image/ktx	KTX	adRASTERIMAGE	
GMSH_Mesh_Fmt	1036	976	GMSH Mesh polygon format	model/mesh	MSH	adCAD	
Collada_DAE_Fmt	1037	977	Collada Digital Asset Exchange (DAE) format	model/vnd.collada+xml	DAE	adCAD	xmlsr
YIN_Fmt	1038	978	YIN XML format	application/yin+xml	YIN	adWORDPROCESSOR	xmlsr
MPEG_Playlist_Fmt	1039	979	MPEG audio playlist format	audio/mpegurl	M3U	adSOUND	
Windows_Audio_Playlist_Fmt	1040	980	Windows Audio playlist format	audio/x-ms-wax	WAX	adSOUND	xmlsr
DTS_Audio_Fmt	1041	981	DTS Coherent Acoustics audio format	audio/vnd.dts	DTS	adSOUND	

Format Name	Number	Category	Description	MIME Type	Extension	File Class	Readers
Chemical_Markup_Language_Fmt	1042	982	Chemical Markup Language (CML) XML format	chemical/x-cml	CML	adWORDPROCESSOR	xmlsr
CrystalMaker_Fmt	1043	983	CrystalMaker chemical format	chemical/x-cmdf	CMDF	adSCIENTIFIC	
VTK_XML_Fmt	1044	984	Visualization Toolkit VTK XML format	model/vnd.vtu	VTU	adVECTORGRAPHIC	xmlsr
IPFIX_Fmt	1045	985	IP Flow Information Export (IPFIX) format	application/ipfix	IPFIX	adMISC	
Portable_Font_Resource_Fmt	1046	986	Portable Font Resource font format	application/font-tdpfr	PFR	adFONT	
MARC_Fmt	1047	987	Machine-Readable Cataloging (MARC21) format	application/marc	MARC	adDATABASE	
MARC_XML_Fmt	1048	988	Machine-Readable Cataloging (MARC) XML format	application/marcxml+xml	XML	adWORDPROCESSOR	xmlsr
XAR_Fmt	1049	989	Extensible Archive (XAR) format			adENCAPSULATION	
Symbian_Installer_Fmt	1050	990	Symbian installer format	application/vnd.symbian.install	SIS	adENCAPSULATION	
SO_Drawing_XML_Fmt	1051	316	OpenDocument format (OpenOffice 1/StarOffice 6.7) Drawing XML	application/vnd.sun.xml.draw	SXD	adVECTORGRAPHIC	kpodfrdr
SO_Text_Global_XML_Fmt	1052	991	OpenDocument format (OpenOffice 1/StarOffice 6.7) Writer Master document XML	application/vnd.sun.xml.writer.global	SXG	adWORDPROCESSOR	
ODF_Chart_Fmt	1053	992	ODF Chart	application/vnd.oasis.opendocument.chart	ODC	adVECTORGRAPHIC	
ODF_Database_Fmt	1054	993	ODF Database	application/vnd.sun.xml.base	ODB	adDATABASE	
ODF_Image_Fmt	1055	994	ODF Image	application/vnd.oasis.opendocument.image	ODI	adRASTERIMAGE	
ODF_Text_Master_Fmt	1056	995	ODF Text Master	application/vnd.oasis.opendocument.text-master	ODM	adWORDPROCESSOR	odfwpsr
ODF_Text_Web_Fmt	1057	996	ODF Text Web	application/vnd.oasis.opendocument.text-web	OTH	adWORDPROCESSOR	odfwpsr
ODF_Chart_Template_Fmt	1058	997	ODF Chart Template	application/vnd.oasis.opendocument.chart-template	OTC	adVECTORGRAPHIC	
ODF_Formula_Template_Fmt	1059	998	ODF Formula Template	application/vnd.oasis.opendocument.formula-template	OTF	adWORDPROCESSOR	unzip

Format Name	Number	Category	Description	MIME Type	Extension	File Class	Readers
ODF_Drawing_Template_Fmt	1060	316	ODF Drawing/Graphics Template	application/vnd.oasis.opendocument.graphics-template	OTG	adVECTORGRAPHIC	kpodfrdr
ODF_Image_Template_Fmt	1061	999	ODF Image Template	application/vnd.oasis.opendocument.image-template	OTI	adRASTERIMAGE	
ODF_Presentation_Template_Fmt	1062	316	ODF Presentation Template	application/vnd.oasis.opendocument.presentation-template	OTP	adPRESENTATION	kpodfrdr
ODF_Spreadsheet_Template_Fmt	1063	315	ODF Spreadsheet Template	application/vnd.oasis.opendocument.spreadsheet-template	OTS	adSPREADSHEET	odfsssr
ODF_Text_Template_Fmt	1064	314	ODF Text Template	application/vnd.oasis.opendocument.text-template	OTT	adWORDPROCESSOR	odfwpsr
ODF_Chart_XML_Fmt	1065	1000	ODF Chart flat XML format	application/vnd.oasis.opendocument.chart.xml	FODC	adVECTORGRAPHIC	
ODF_Drawing_XML_Fmt	1066	1001	ODF Drawing/Graphics flat XML format	application/vnd.oasis.opendocument.formula.xml	FODG	adWORDPROCESSOR	
ODF_Formula_XML_Fmt	1067	1002	ODF Formula flat XML format	application/vnd.oasis.opendocument.graphics.xml	FODF	adVECTORGRAPHIC	
ODF_Image_XML_Fmt	1068	1003	ODF Image flat XML format	application/vnd.oasis.opendocument.image.xml	FODI	adRASTERIMAGE	
ODF_Presentation_XML_Fmt	1069	1004	ODF Presentation flat XML format	application/vnd.oasis.opendocument.presentation.xml	FODP	adPRESENTATION	
ODF_Spreadsheet_XML_Fmt	1070	1005	ODF Spreadsheet flat XML format	application/vnd.oasis.opendocument.spreadsheet.xml	FODS	adSPREADSHEET	
ODF_Text_XML_Fmt	1071	1006	ODF Text flat XML format	application/vnd.oasis.opendocument.text.xml	FODT	adWORDPROCESSOR	
ODF_Extension_Fmt	1072	1007	ODF Extension format	application/vnd.openofficeorg.extension	OXT	adMISC	
StarView_Metafile_Fmt	1073	1008	OpenOffice StarView MetaFile format	image/x-svm	SVM	adRASTERIMAGE	
BBeB_LRF_eBook_Fmt	1074	1009	Broad Band eBook (BBeB) in LRF format	application/x-ext-lrf	LRF	adWORDPROCESSOR	
GPG_Trust_DB_Fmt	1075	1010	GPG trust database format		GPG	adMISC	
VICE_Emulator_Fmt	1076	1011	VICE (Versatile Commodore Emulator) format		VSF	adMISC	
Portable_Game_Notation_Fmt	1077	1012	Portable Game Notation chess format	application/vnd.chess-pgn	PGN	adWORDPROCESSOR	
Doom_WAD_Fmt	1078	1013	Doom IWAD/PWAD format	application/x-doom	WAD	adMISC	

Format Name	Number	Category	Description	MIME Type	Extension	File Class	Readers
Device_Tree_Blob_Fmt	1079	1014	Linux Device Tree Blob format		DTB	adMISC	
BDF_Font_Fmt	1080	1015	Glyph Bitmap Distribution Format	application/x-font-bdf	BDF	adFONT	
PC_Screen_Font_Fmt	1081	1016	PC Screen Font format	application/x-font-psf	PSF	adFONT	
JNLP_Fmt	1082	1017	Java Network Launching Protocol	application/x-java-jnlp-file	JNLP	adWORDPROCESSOR	xmlsr
XAML_Browser_Application_Fmt	1083	1018	XAML Browser Application (XBAP) format	application/x-ms-xbap	XBAP	adWORDPROCESSOR	xmlsr
MS_Binder_Fmt	1084	1019	Microsoft Office Binder format	application/x-msbinder	OBP	adENCAPSULATION	olesr
XAP_Fmt	1085	1020	Microsoft Silverlight application (XAP) format	application/x-silverlight-app	XAP	adENCAPSULATION	
Stuffit_X_Fmt	1086	1021	Stuffit X (SITX) archive format	application/x-stuffitx	SITX	adENCAPSULATION	
FIG_Fmt	1087	1022	Facility for Interactive Generation of figures (FIG) image format	application/x-fig	FIG	adVECTORGRAPHIC	
XPIInstall_Fmt	1088	1023	XPIInstall Cross-Platform Installer Module (XPI) format	application/x-xpinstall	XPI	adENCAPSULATION	
XDF_Fmt	1089	1024	Extensible Data Format (XDF) XML format		XDF	adWORDPROCESSOR	xmlsr
MXML_Fmt	1090	1025	MXML UI markup language XML format		MXML	adWORDPROCESSOR	xmlsr
MusicXML_Fmt	1091	1026	MusicXML format	application/vnd.recordare.musicxml	MXL	adENCAPSULATION	xmlsr
Finale_Fmt	1092	1027	Finale audio format		MUS	adSOUND	
Spotfire_DXP_Fmt	1093	1028	TIBCO Spotfire DXP data format	application/vnd.spotfire.dxp	DXP	adANALYTICS	
MS_Office_Theme_2007_Fmt	1094	1029	Microsoft Office theme format	application/vnd.ms-officetheme	THMX	adMISC	
Adobe_AIR_Installer_Fmt	1095	1030	Adobe AIR application installer package	application/vnd.adobe.air-application-installer-package+zip	AIR	adENCAPSULATION	
Flex_Project_Fmt	1096	1031	Adobe Flash Flex project file format	application/vnd.adobe.fxp	FXP	adENCAPSULATION	

Format Name	Number	Category	Description	MIME Type	Extension	File Class	Readers
FoxPro_Fmt	1097	1032	FoxPro compiled source format		FXP	adLIBRARY	
VST_Preset_Fmt	1098	1033	Virtual Studio Technology (VST) preset format		FXP	adSOUND	
Mischief_Image_Fmt	1099	1034	Mischief vector graphics image format		ART	adVECTORGRAPHIC	
FreeArc_Fmt	1100	1035	FreeArc archive format	application/x-freearc	ARC	adENCAPSULATION	
Autodesk_3ds_Fmt	1101	1036	Autodesk 3ds format	application/x-3ds	3DS	adCAD	
Monkeys_Audio_Fmt	1102	1037	Monkey's Audio format		APE	adSOUND	
CALS_Fmt	1103	1038	CALS raster image format		CAL	adRASTERIMAGE	
Dr_Halo_PAL_Fmt	1104	1039	Dr Halo raster image PAL file format		PAL	adRASTERIMAGE	
DPG_Fmt	1105	1040	Nintendo DS DPG video format		DPG	adMOVIE	
JPEG_XR_Fmt	1106	1041	JPEG XR (extended range) image format	image/vnd.ms-photo	JXR, HDP	adRASTERIMAGE	
TCR_eBook_Fmt	1107	1042	TCR/ZVR (Text Compression for Reader) eBook format		TCR, ZVR	adWORDPROCESSOR	
IHEX_Fmt	1108	1043	Intel Hex format		IHEX	adENCAPSULATION	
QCOW_Fmt	1109	1044	QEMU Copy On Write		QCOW	adENCAPSULATION	
VDI_Fmt	1110	1045	VirtualBox Disk Image		VDI	adENCAPSULATION	
OneNote_Alternate_Fmt	1111	1046	OneNote Alternative Packaging Format			adWORDPROCESSOR	onealtsr
RMS_Protected_Fmt	1112	1047	Rights Management Services (RMS)-protected format		PFILE, PPDF, PJPG, PTXT	adWORDPROCESSOR	pfilesr
Portfolio_PDF_Fmt	1113	1048	Portfolio PDF File	application/pdf	PDF	adWORDPROCESSOR	pdfsr
Crystal_Reports_Fmt	1114	1049	SAP Crystal Reports format	application/x-rpt	RPT	adANALYTICS	olesr
Thumbs_db_Fmt	1115	1050	Microsoft Windows thumbs.db format		DB	adENCAPSULATION	
PagePlus_Fmt	1116	1051	Serif PagePlus format		PPP	adDESKTOPPUBLSH	olesr
MS_Project_Exchange_	1117	1052	Microsoft Project		MPX	adSCHEDULE	

Format Name	Number	Category	Description	MIME Type	Extension	File Class	Readers
Fmt			Exchange format				
MS_Management_Pack_MPX_Fmt	1118	1053	Microsoft Systems Center Operation Manager (SCOM) management pack MPX format		MPX	adMISC	xmlsr
AutoCAD_VBA_Project_Fmt	1119	1054	AutoCAD VBA project format		DVB	adMISC	
PLY_ASCII_Fmt	1120	1055	Polygon File Format (PLY) ASCII format		PLY	adCAD	
PLY_Binary_Fmt	1121	1056	Polygon File Format (PLY) binary format		PLY	adCAD	
JavaView_JVX_Fmt	1122	1057	JavaView XML (JVX) format		JVX	adCAD	xmlsr
X3D_Fmt	1123	1058	Extensible 3d Graphics (X3D) XML format	model/x3d+xml	X3D	adCAD	
ZBrush_Project_Fmt	1124	1059	ZBrush ZProject (ZPR) format		ZPR	adCAD	
ZBrush_Tool_Fmt	1125	1060	ZBrush ZTtool (ZTL) format		ZTL	adCAD	
Windows_Installer_Patch_Fmt	1126	1061	Microsoft Windows Installer Patch Package (MSP) format		MSP	adENCAPSULATION	olesr
Windows_Installer_Transform_Fmt	1127	1062	Microsoft Windows Installer Transform (MST) format		MST	adENCAPSULATION	
Lotus_Approach_Fmt	1128	1063	Lotus Approach format	application/vnd.lotus-approach	APR, MPR	adDATABASE	
Outlook_SendRcv_Settings_Fmt	1129	1064	Microsoft Outlook 2002 Send-Receive Settings		SRS	adMISC	
MS_Publisher_Scheme_Fmt	1130	1065	Microsoft Publisher colour scheme		SCM	adMISC	
SO_Chart_Fmt	1131	1066	Star Office 4,5 Chart	application/vnd.stardivision.chart	SDS	adVECTORGRAPHIC	olesr
SO_Database_Fmt	1132	1067	Star Office 4,5 Database	application/vnd.stardivision.base	SDB	adDATABASE	olesr
SO_Library_Fmt	1133	1068	Star Office 4,5 Library		SBL	adLIBRARY	
PageMaker_Document_Fmt	1134	1069	Adobe PageMaker document	application/pagemaker	PMD	adDESKTOPPUBLSH	

Format Name	Number	Category	Description	MIME Type	Extension	File Class	Readers
MS_DTS_Fmt	1135	1070	Microsoft Data Transformation Services (DTS) package file		DTS	adMISC	
Cognos_PowerPlay_PPR_Fmt	1136	1071	Cognos PowerPlay up to version 7 (PPR) format		PPR	adANALYTICS	
Visual_Studio_SUO_Fmt	1137	1072	Microsoft Visual Studio solution user options (suo) file		SUO	adMISC	
MS_GraphEdit_Fmt	1138	1073	Microsoft GraphEdit File format		GRF	adMISC	
ArcGIS_Graph_Fmt	1139	1074	ArcGIS Graph format		GRF	adGIS	
SID_Audio_Fmt	1140	1075	SID Audio format	audio/prs.sid	SID	adSOUND	
MrSID_Fmt	1141	1076	LizardTech MrSID image format	image/x-mrsid	SID	adRASTERIMAGE	
Cardfile_Fmt	1142	1077	Microsoft Windows Cardfile address book format	application/x-mscardfile	CRD	adWORDPROCESSOR	
MS_Word_Mac_4_Fmt	1143	205	Microsoft Word for Macintosh (version 4,5)	application/msword	DOC	adWORDPROCESSOR	mbsr
WordPerfect_5_Fmt	1144	80	WordPerfect (version 5)	application/x-corel-wordperfect	WOP, DOC	adWORDPROCESSOR	wosr
WordPerfect_6_Fmt	1145	178	Corel WordPerfect (version 6 and higher)	application/x-corel-wordperfect	WPD	adWORDPROCESSOR	wp6sr
WordPerfect_Graphics_1_Fmt	1146	85	WordPerfect Graphics (version 1)	application/vnd.wordperfect	WPG, QPG	adRASTERIMAGE, adVECTORGRAPHIC	
Organization_Chart_Fmt	1147	1078	OrgPlus Organization Chart	application/orgplus	OPX	adDATABASE	
Lotus_Organizer_Fmt	1148	1079	Lotus Organizer documents	application/vnd.lotus-organizer	OR2, OR3, OR4, OR5, OR6	adSCHEDULE	
MS_DBML_Fmt	1149	1080	Microsoft Database Markup Language XML document		DBML	adWORDPROCESSOR	
XMind_Fmt	1150	1081	XMind document	application/xmind	XMIND	adPRESENTATION	
MSI_Cerius_Fmt	1151	1082	MSI Cerius chemical formula document	chemical/x-cerius	MSI	adSCIENTIFIC	
GenBank_Fmt	1152	1083	GenBank DNA character sequence document	chemical/x-genbank	GB	adSCIENTIFIC	

Format Name	Number	Category	Description	MIME Type	Extension	File Class	Readers
GIS_World_File_Fmt	1153	1084	ESRI GIS World file		BPW, GFW, JGW, J2W, PGW, SDW, TFW, WLD	adGIS	afsr
GIS_Projection_Metadata_Fmt	1154	1085	ESRI Projection Metadata (PRJ) file		PRJ	adGIS	
PowerWorld_Binary_Fmt	1155	1086	PowerWorld Binary (PWB) file		PWB	adCAD	
PowerWorld_Display_Fmt	1156	1087	PowerWorld Display (PWD) file		PWD	adCAD	
ArcXML_Fmt	1157	1088	ESRI ArcIMS project XML file (ArcXML)		AXL	adGIS	
GAMS_GDX_Fmt	1158	1089	General Algebraic Modeling System (GAMS) Data Exchange (GDX) format		GDX	adSCIENTIFIC	
ArcMap_MXD_Fmt	1159	1090	ArcMap Map Exchange Document project (MXD)		MXD	adGIS	
RRDtool_Fmt	1160	1091	RRDtool (Round Robin Database) data file		RRD	adDATABASE	
HWPX_Fmt	1161	1092	Hangul HWPX document	application/hwp+zip	HWPX	adWORDPROCESSOR	hwpxsr
SolidWorks_2015_Fmt	1162	1093	SolidWorks (2015 onwards) file		SLDPRT, SLDDRW, SLDASM	adCAD	
MS_Photo_Editor_Fmt	1163	1094	Microsoft Photo Editor 'embedded GIF' file	application/vnd.ms-photo-editor		adRASTERIMAGE	
MS_Word_HTML_Fmt	1164	1095	Microsoft Word HTML format		DOC, HTM	adWORDPROCESSOR	
MS_Excel_HTML_Fmt	1165	1096	Microsoft Excel HTML format		XLS, HTM	adWORDPROCESSOR	
Portable_FloatMap_Fmt	1166	1097	Portable FloatMap (PFM) image	image/x-portable-floatmap	PFM	adRASTERIMAGE	
RGBE_Fmt	1167	1098	Radiance RGBE (HDR) image	image/vnd.radiance	HDR, PIC, RGBE, XYZE	adRASTERIMAGE	
APNG_Fmt	1168	1099	Animated Portable Network Graphics (Animated-PNG)	image/apng	APNG, PNG	adANIMATION	kppngrdr
Enhanced_Compressed_	1169	1100	Enhanced Compressed	image/ecw	ECW	adRASTERIMAGE	

Format Name	Number	Category	Description	MIME Type	Extension	File Class	Readers
Wavelet_Fmt			Wavelet image				
Ensoniq_Waveset_Fmt	1170	1101	Ensoniq Waveset audio data file		ECW	adSOUND	
Corel_Photo_Paint_Fmt	1171	1102	Corel Photo Paint (version 7 and higher)	image/x-corelphotopaint	CPT	adRASTERIMAGE	
OpenRaster_Fmt	1172	1103	OpenRaster image	image/openraster	ORA	adRASTERIMAGE	
Krita_Fmt	1173	1104	Krita image	application/x-krita	KRA	adRASTERIMAGE	
Gerber_Fmt	1174	1105	Gerber image format	application/vnd.gerber	GBR	adVECTORGRAPHIC	
PGML_Fmt	1175	1106	Precision Graphics Markup Language		PGML	adVECTORGRAPHIC	xmlsr
Away3D_Fmt	1176	1107	Away3D scene file		AWD	adCAD	
CAD_3MF_Fmt	1177	1108	3D Manufacturing Format document	application/vnd.ms-package.3dmanufacturing-3dmodel+xml	3MF	adCAD	
AMF_Fmt	1178	1109	Additive manufacturing file format (AMF) document	application/x-amf	AMF	adCAD	xmlsr
C3D_Fmt	1179	1110	Coordinate 3D (C3D) format		C3D	adCAD	
CAD_3DSystems_BFF_Fmt	1180	1111	3D Sprint (3D Systems) SLA Build file		BFF	adCAD	
NRRD_Fmt	1181	1112	NRRD (nearly raw raster data) image format		NRRD	adRASTERIMAGE	
Cinema_4D_Fmt	1182	1113	Cinema 4D model		C4D	adCAD	
FBX_ASCII_Fmt	1183	1114	Kaydara FBX project (ASCII)		FBX	adCAD	
FBX_Binary_Fmt	1184	1115	Kaydara FBX project (binary)		FBX	adCAD	
Wavefront_OBJ_Fmt	1185	1116	Wavefront OBJ geometry definition file		OBJ	adCAD	
Wavefront_MTL_Fmt	1186	1117	Wavefront Material Template Library (MTL)		MTL	adCAD	
MS_Power_BI_Template_Fmt	1187	1118	Microsoft Power BI Desktop template format		PBIT	adANALYTICS	
Windows_Sticky_Notes_Fmt	1188	1119	Microsoft Windows Sticky Notes format		SNT	adWORDPROCESSOR	

Format Name	Number	Category	Description	MIME Type	Extension	File Class	Readers
BlakHole_Fmt	1189	1120	BlakHole compression format		BH	adENCAPSULATION	
PowerArchiver_Fmt	1190	1121	PowerArchiver PA compression format		PA	adENCAPSULATION	
PageMagic_Fmt	1191	1122	NEBS PageMagic format		DTP	adDESKTOPPUBLSH	olesr
PIM_Archiver_Fmt	1192	1123	PIM Archiver format		PIM	adENCAPSULATION	
Softdisk_Text_Compessor_Fmt	1193	1124	Softdisk Text Compressor format		CTX	adENCAPSULATION	
Ability_PhotoPaint_Fmt	1194	1125	Ability Office PhotoPaint image		APX	adRASTERIMAGE	
Softlib_Fmt	1195	1126	Softdisk Softlib compression format		SLB	adENCAPSULATION	
Timeworks_Publisher_Fmt	1196	1127	Timeworks Publisher (Publish It) format		DTP	adDESKTOPPUBLSH	
Scribe_Fmt	1197	1128	Scribe markup language and word processing system		MSS	adWORDPROCESSOR	afsr
SQLite_Write_Ahead_Log_Fmt	1198	1129	SQLite Write-Ahead Log file		WAL	adDATABASE	
SQLite_WAL_Index_Fmt	1199	1130	SQLite WAL-index (shm) file		SHM	adDATABASE	
AutoForm_Design_Fmt	1200	1131	AutoForm Design file		AFD	adCAD	
TSV_Fmt	1201	1132	Tab-separated values (TSV) file	text/tab-separated-values	TSV, TAB	adWORDPROCESSOR	afsr , afsr
OpenStreetMap_XML_Fmt	1202	1133	OpenStreetMap XML data		OSM	adGIS	
OpenStreetMap_PBF_Fmt	1203	1134	OpenStreetMap Protocolbuffer Binary Format data file (.osm.pbf)		PBF	adGIS	
Nero_Audio_Compilation_Fmt	1204	1135	Nero Audio-CD compilation file		NRA	adMISC	
Nero_ISO_Compilation_Fmt	1205	1136	Nero ISO compilation file		NRI	adMISC	
WordStar_for_Windows_Fmt	1206	1137	WordStar for Windows file		WSD	adWORDPROCESSOR	stringssr

Format Name	Number	Category	Description	MIME Type	Extension	File Class	Readers
MS_Outlook_PAB_Fmt	1207	1138	Microsoft Outlook Personal Address Book (PAB)		PAB	adMISC	
HLSL_FXO_Fmt	1208	1139	DirectX High-Level Shader Language (HLSL) pre-compiled shader		FXO	adCAD	
HLSL_CSO_Fmt	1209	1140	DirectX High-Level Shader Language (HLSL) compiled shader object		CSO	adCAD	
Oberon_Document_Fmt	1210	1141	Component Pascal / Oberon Document file		ODC	adSOURCECODE	
Oberon_Symbol_Fmt	1211	1142	Component Pascal / Oberon Symbol file		OSF	adOBJECTMODULE	
Oberon_Code_Fmt	1212	1143	Component Pascal / Oberon Code (executable and loadable object) file		OCF	adEXECUTABLE	
Python_Bytecode_Fmt	1213	1144	Python compiled bytecode	application/x-bytecode.python	PYC	adEXECUTABLE	
PCPaint_Fmt	1214	1145	PCPaint / Pictor Paint image format		PIC	adRASTERIMAGE	
PCRaster_Map_Fmt	1215	1146	PCRaster Map / Cross System Format geographical data		MAP, CSF	adGIS	
COM_Type_Library_Fmt	1216	1147	Microsoft Component Object Model (COM) Type library		TLB	adLIBRARY	
MS_Visual_C_Export_Fmt	1217	1148	Microsoft Visual C++ Export file		EXP	adLIBRARY	
Lotus_Organizer_Report_Fmt	1218	1149	Lotus Organizer report document		REP	adSCHEDULE	
Audible_Audiobook_AA_Fmt	1219	1150	Audible Audiobook (AA) file	audio/audible	AA	adSOUND	
DOS_RED_Fmt	1220	1151	MS-DOS RED installer library format		RED	adLIBRARY	
CA_ZIPXP_Fmt	1221	1152	CA Technologies ZIPXP compressed document		CAZ	adENCAPSULATION	
Kindle_Topaz_Fmt	1222	1153	Amazon Kindle Topaz eBook		AZW, AZW1, TPZ	adWORDPROCESSOR	

Format Name	Number	Category	Description	MIME Type	Extension	File Class	Readers
Windows_Shim_Database_Fmt	1223	1154	Microsoft Windows Shim Database file		SDB	adDATABASE	
MS_Incremental_Linker_Fmt	1224	1155	Microsoft Visual Studio incremental linker file		ILK	adMISC	
Lotus_Smart_Icon_Fmt	1225	1156	Lotus Smart Icon image file		SMI	adRASTERIMAGE	
Lotus_Organizer_Layout_Fmt	1226	1157	Lotus Organizer print/paper layout file		PLT	adSCHEDULE	
CMZ_Fmt	1227	1158	CMZ compression format		CMZ	adENCAPSULATION	
RFFlow_Fmt	1228	1159	RFFlow flowchart document		FLO	adPRESENTATION	
InstallShield_Script_Fmt	1229	1160	InstallShield script document		INS	adENCAPSULATION	
InstallShield_Rules_Fmt	1230	1161	InstallShield Compiled Rules file		INX	adENCAPSULATION	
Windows_FTS_Fmt	1231	1162	Microsoft Windows 95/NT help full-text-search file		FTS	adDATABASE	
DVD_Info_Fmt	1232	1163	DVD Information (IFO) file	content/dvd	IFO	adDATABASE	
Emacs_Lisp_Bytecode_Fmt	1233	1164	Byte-compiled Lisp (Emacs/XEmacs)	application/x-bytecode.elisp	ELC	adEXECUTABLE	
Windows_Resource_Fmt	1234	1165	Microsoft Windows binary resource file		RES	adMISC	
MS_Precompiled_Header_Fmt	1235	1166	Microsoft Visual C/C++ binary pre-compiled header		PCH	adMISC	
Borland_Turbo_Project_Fmt	1236	1167	Borland Turbo C project file		PRJ	adMISC	
PS_Font_Descriptor_Fmt	1237	1168	PostScript binary Font Descriptor file		NTF	adFONT	
MySQL_Index_Fmt	1238	1169	MySQL MyISAM Table index		MYI	adDATABASE	
MS_SQL_Fmt	1239	1170	Microsoft SQL Server primary database file		MDF	adDATABASE	
DNL_eBook_Fmt	1240	1171	DNAML DNL eBook		DNL	adWORDPROCESSOR	
GD_Image_Fmt	1241	1172	GD Library image		GD, GD2	adRASTERIMAGE	
iTunes_Library_Fmt	1242	1173	Apple iTunes music library		ITL	adDATABASE	

Format Name	Number	Category	Description	MIME Type	Extension	File Class	Readers
MS_SQM_Fmt	1243	1174	Microsoft Windows Live Messenger/Mail log file		SQM	adMISC	
VIFF_Fmt	1244	1175	Khoros Visualization Image File Format (VIFF)	image/x-viff	XV, VIF, VIFF	adRASTERIMAGE	
JBIG_Fmt	1245	1176	JBIG (JBIG1) image	image/jbig	JBG, JBIG, BIE	adRASTERIMAGE	
CodeWarrior_Project_Fmt	1246	1177	CodeWarrior C/C++ project		MCP	adMISC	
PaintShop_Pro_JBF_Fmt	1247	1178	PaintShop Pro JBF image cache file	image/jbf	JBF	adMISC	
Delphi_Diagram_Portfolio_Fmt	1248	1179	Delphi Diagram Portfolio file		DDP	adMISC	
Adobe_Swatch_Exchange_Fmt	1249	1180	Adobe Swatch Exchange Format		ASE, ASEF	adRASTERIMAGE	
ASCII_Scene_Exporter_Fmt	1250	1181	Autodesk 3ds Max ASCII Scene Exporter file		ASE	adCAD	
AVR_Fmt	1251	1182	AVR (Audio Visual Research) format		AVR	adSOUND	
Winamp_AVS_Fmt	1252	1183	Winamp AVS (Advanced Visualization Studio) plug-in file		AVS	adSOUND	
After_Effects_Project_Fmt	1253	1184	Adobe After Effects project		AEP	adMOVIE	
Anfy_Applet_Generator_Fmt	1254	1185	Anfy (Java) Applet Generator file		AJP	adMISC	
SmartCipher_Fmt	1255	1186	SmartCipher encrypted file			adENCAPSULATION	
General_Exchange_Fmt	1256	1187	General Exchange Format (GXF)	application/gxf	GXF	adMOVIE	
Maxis_XA_Fmt	1257	1188	Maxis XA audio file		XA	adSOUND	
NUT_Fmt	1258	1189	NUT Open Container Format		NUT	adMOVIE	
OpenMG_Audio_Fmt	1259	1190	Sony OpenMG Audio (OMA) container file		OMA, OMG	adSOUND	
TXD_Fmt	1260	1191	Renderware Texture Dictionary (TXD) file		TXD	adRASTERIMAGE	
DFA_Fmt	1261	1192	DreamForge DFA FMV format		DFA	adMOVIE	

Format Name	Number	Category	Description	MIME Type	Extension	File Class	Readers
FunCom_ISS_Fmt	1262	1193	FunCom ISS audio		ISS	adSOUND	
Sony_MSV_Fmt	1263	1194	Sony Compressed Audio (MSV/DVF)		DVF, ICS, MSV	adSOUND	
THP_Fmt	1264	1195	GameCube THP Video		THP	adMOVIE	
Smush_Animation_Fmt	1265	1196	Smush Animation Format (SAN)		SAN, NUT	adANIMATION	
SIFF_Audio_Fmt	1266	1197	Beam Software SIFF audio file		SON	adSOUND	
SNES_SPC_Fmt	1267	1198	SNES SPC700 audio file		SPC	adSOUND	
Sierra_VMD_Fmt	1268	1199	Sierra Video and Music Data format		VMD	adMOVIE	
VTech_MJP_Fmt	1269	1200	VTech MHP video format		MJP	adMOVIE	
Nullsoft_Video_Fmt	1270	1201	Nullsoft Video format (NSV)		NSV	adMOVIE	
Shorten_Fmt	1271	1202	Shorten audio file		SHN	adSOUND	
Leitch_Video_Fmt	1272	1203	Leitch Exchange Format video (LXF)		LXF	adMOVIE	
ETV_Fmt	1273	1204	ETV video file		ETV	adMOVIE	
TAK_Audio_Fmt	1274	1205	TAK audio file		TAK	adSOUND	
Maelstrom_ANM_Fmt	1275	1206	Maelstrom ANM animation		ANM	adANIMATION	
SW_ANM_Fmt	1276	1207	Savage Warriors ANM animation		ANM	adANIMATION	
DeluxePaint_Animation_Fmt	1277	1208	DeluxePaint animation		ANM	adANIMATION	
Crack_Art_Fmt	1278	1209	Crack Art image		CA1	adRASTERIMAGE	
Time_Shift_Video_Fmt	1279	1210	Time Shift Video (TSV) format		TSV	adMOVIE	
XBV_Fmt	1280	1211	XBV video		XBV	adMOVIE	
HNM4_Fmt	1281	1212	CRYO HNM4 video		HNM	adMOVIE	
HNM6_Fmt	1282	1213	CRYO HNM6 video		HNM, HNS	adMOVIE	
NXV_Fmt	1283	1214	NXV video		NXV	adMOVIE	
VP5_Fmt	1284	1215	On2 VP5 video		VP5	adMOVIE	

Format Name	Number	Category	Description	MIME Type	Extension	File Class	Readers
FutureVision_FST_Fmt	1285	1216	FutureVision FST video		FST	adMOVIE	
Electronic_Arts_Audio_Fmt	1286	1217	Electronic Arts audio file		STR	adSOUND	
YOP_Fmt	1287	1218	Psygnosis YOP video		YOP	adMOVIE	
Matrox_Setup_Program_Fmt	1288	1219	Matrox Setup Program Archive MVA file		MVA	adMISC	
Vivado_Design_Suite_Fmt	1289	1220	Xilinx Vivado Design Suite file		VDS	adMISC	
Meridian_Lossless_Packing_Fmt	1290	1221	Meridian Lossless Packing Audio file		MLP	adSOUND	
Electronic_Arts_SEAD_Fmt	1291	1222	Electronic Arts SEAD audio		TGV	adSOUND	
Electronic_Arts_MPC_Fmt	1292	1223	Electronic Arts MPC video		MPC	adMOVIE	
PMP_Fmt	1293	1224	PMP video		PMP	adMOVIE	
DEGAS_Fmt	1294	1225	DEGAS (Design & Entertainment Graphic Arts System) image		PI1, PI2, PI3	adRASTERIMAGE	
DEGAS_Compressed_Fmt	1295	1226	DEGAS (Design & Entertainment Graphic Arts System) compressed image		PC1, PC2, PC3	adRASTERIMAGE	
AutoCAD_Plotter_Fmt	1296	1227	AutoCAD Plot Style and Configuration files		CTB, STB, PC3, PMP	adCAD	
Tiny_Stuff_Fmt	1297	1228	Tiny Stuff image		TNY, TN1, TN2, TN3, TN4, TN5, TN6	adRASTERIMAGE	
JV_Video_Fmt	1298	1229	Bitmap Brothers JV video		JV	adMOVIE	
REDCode_Fmt	1299	1230	REDCode video format		R3D	adMOVIE	
SIFF_Video_Fmt	1300	1231	Beam Software SIFF video file		VB	adMOVIE	
VP6_Fmt	1301	1232	On2 VP6 video		VP6	adMOVIE	
MTV_Fmt	1302	1233	Chinese MP4/MTV video		MTV	adMOVIE	
RSO_Fmt	1303	1234	Mindstorm RSO audio		RSO	adSOUND	
Star3_Fmt	1304	1235	Creative Labs Star 3 audio		ST3	adSOUND	

Format Name	Number	Category	Description	MIME Type	Extension	File Class	Readers
DXA_Fmt	1305	1236	Runesoft DXA video		DXA	adMOVIE	
MTH_Fmt	1306	1237	Nintendo GameCube video file		MTH	adMOVIE	
MAD_Fmt	1307	1238	Electronic Arts MAD video file		MAD	adMOVIE	
Bink2_Fmt	1308	1239	Bink Video 2 audio-video container		BIK, BK2	adMOVIE	
PVA_Fmt	1309	1240	TechnoTrend PVA video		PVA	adMOVIE	
Interplay_ACMP_Fmt	1310	1241	Interplay ACMP audio			adSOUND	
Ipix_Fmt	1311	1242	Ipix spherical image		IPX	adRASTERIMAGE	
IVR_Fmt	1312	1243	RealNetworks Internet Video Recording (IVR) file		IVR	adMOVIE	
NuppelVideo_Fmt	1313	1244	NuppelVideo file		NUV	adMOVIE	
VFlash_PTX_Fmt	1314	1245	VTech V.Flash VTX image		PTX	adRASTERIMAGE	
PMD_Ringtone_Fmt	1315	1246	Polyphonic Ringtone PMD audio	application/x-pmd	PMD	adSOUND	
RoQ_Fmt	1316	1247	RoQ video		ROQ	adMOVIE	
CRYO_APC_Fmt	1317	1248	CRYO Interactive APC audio		APC, HNM, BF, ZIK	adSOUND	
VGZ_Fmt	1318	1249	VGZ video		VGZ	adMOVIE	
Novastorm_Video_Fmt	1319	1250	Novastorm Media video file		FA, FLM	adMOVIE	
UTalk_Fmt	1320	1251	MicroTalk/UTalk audio		UTK	adSOUND	
Xbox_XMV_Fmt	1321	1252	Microsoft Xbox XMV video		XMV	adMOVIE	
AbiWord_Fmt	1322	1253	AbiWord document	application/x-abiword	ABW	adWORDPROCESSOR	xmlsr
AbiWord_Template_Fmt	1323	1254	AbiWord template		ABT	adWORDPROCESSOR	
Psion_Word_Fmt	1324	1255	Psion EPOC Word document		PSI, PSITEXT	adWORDPROCESSOR	stringssr
Psion_Sheet_Fmt	1325	1256	Psion EPOC Sheet spreadsheet		PSISHEET	adSPREADSHEET	
Psion_Sketch_Fmt	1326	1257	Psion EPOC Sketch image			adRASTERIMAGE	
Psion_Record_Fmt	1327	1258	Psion EPOC Record audio			adSOUND	

Format Name	Number	Category	Description	MIME Type	Extension	File Class	Readers
Psion_MBM_Fmt	1328	1259	Psion EPOC Multi-Bitmap (MBM) image		MBM	adRASTERIMAGE	
Psion_TextEd_Fmt	1329	1260	Psion EPOC TextEd file			adWORDPROCESSOR	stringssr
Psion_AIF_Fmt	1330	1261	Psion EPOC Application Information File (AIF)		AIF	adRASTERIMAGE	
Psion_PIC_Fmt	1331	1262	Psion 3 PIC bitmap		PIC	adRASTERIMAGE	
Psion_Object_Fmt	1332	1263	Psion 3 OPL Object File		OPA, OPO	adENCAPSULATION	
Psion_Executable_Fmt	1333	1264	Psion 3 IMG/APP executable		IMG, APP	adEXECUTABLE	
Psion_Sound_Fmt	1334	1265	Psion 3 Sound file		WVE	adSOUND	
Psion_Database_Fmt	1335	1266	Psion EPOC Database			adDATABASE	
Psion_Word_3_Fmt	1336	1267	Psion 3 Word document		WRD	adWORDPROCESSOR	stringssr
Psion_Sheet_3_Fmt	1337	1268	Psion 3 Sheet spreadsheet		SPR	adSPREADSHEET	
Zoner_Draw_Fmt	1338	1269	Zoner Draw / Zoner Callisto Metafile (ZMF)		ZMF	adVECTORGRAPHIC	
Zoner_BMI_Fmt	1339	1270	Zoner BMI image		BMI	adRASTERIMAGE	
TealDoc_Fmt	1340	1271	TealDoc PalmOS eBook		PDB	adWORDPROCESSOR	
TealPaint_Fmt	1341	1272	TealPaint PalmOS eBook		PDB	adWORDPROCESSOR	
PalmDOC_Fmt	1342	1273	PalmDOC / Aportis DOC eBook	application/x-aporisdoc	PRC, PDB	adWORDPROCESSOR	
QiOO_Fmt	1343	1274	QiOO mobile eBook		JAR	adWORDPROCESSOR	
Plucker_Fmt	1344	1275	Plucker eBook	application/prs.plucker	PDB	adWORDPROCESSOR	
eReader_Fmt	1345	1276	eReader (Palm Reader/ Peanut Reader) eBook		PDB	adWORDPROCESSOR	
Quickword_Fmt	1346	1277	PalmOS Quickword document		PRC	adWORDPROCESSOR	stringssr
Quicksheet_Fmt	1347	1278	PalmOS Quicksheet document		PRC	adSPREADSHEET	
Quickpoint_Fmt	1348	1279	PalmOS Quickpoint document		PRC	adPRESENTATION	
TealMeal_Fmt	1349	1280	TealMeal PalmOS database		PDB	adDATABASE	
zTXT_Fmt	1350	1281	zTXT eBook	application/x-pdb-ztxt-ebook	PDB	adWORDPROCESSOR	

Format Name	Number	Category	Description	MIME Type	Extension	File Class	Readers
TomeRaider_Fmt	1351	1282	TomeRaider eBook		TR	adWORDPROCESSOR	
TomeRaider_PDB_Fmt	1352	1283	TomeRaider PDB eBook		TR2, TR3	adWORDPROCESSOR	
WordSmith_Fmt	1353	1284	PalmOS Wordsmith document			adWORDPROCESSOR	
iSilo_Fmt	1354	1285	PalmOS iSilo document	application/x-pdb-isilo-ebook	PDB	adWORDPROCESSOR	
SuperMemo_Fmt	1355	1286	PalmOS SuperMemo document		KNO, PDB	adWORDPROCESSOR	
BDicty_Fmt	1356	1287	PalmOS BDicty document		PDB	adWORDPROCESSOR	
PalmOS_Executable_Fmt	1357	1288	PalmOS executable	application/vnd.palm	PRC	adEXECUTABLE	
PalmOS_Library_Fmt	1358	1289	PalmOS dynamic library		PRC	adLIBRARY	
Shanda_Bambook_Fmt	1359	1290	Shanda Bambook eBook	application/x-snb-ebook	SNB	adWORDPROCESSOR	
PMLZ_Fmt	1360	1291	Palm Markup Language (PMLZ) eBook		PMLZ	adWORDPROCESSOR	
Rocket_eBook_Fmt	1361	1292	Rocket eBook	application/x-rocketbook	RB	adWORDPROCESSOR	
iBooks_Author_Fmt	1362	1293	Apple iBooks Author eBook	application/vnd.apple.ibauthor	IBA	adWORDPROCESSOR	
Statistica_Spreadsheet_Fmt	1363	1294	Statsoft Statistica Spreadsheet		STA	adSPREADSHEET	
Statistica_Graph_Fmt	1364	1295	Statsoft Statistica Graph File		STG	adVECTORGRAPHIC	
Statistica_Scrollsheet_Fmt	1365	1296	Statsoft Statistica Scrollsheet		SCR	adSPREADSHEET	
Apple_Newton_Package_Fmt	1366	1297	Apple Newton executable/installer/file		PKG	adEXECUTABLE	
Adobe_Zip_Extension_Fmt	1367	1298	Adobe Zip Format Extension Package (ZXP)	application/vnd.adobe.air-ucf-package+zip	ZXP	adENCAPSULATION	
Uniform_Office_Fmt	1368	1299	Uniform Office Format document		UOF	adWORDPROCESSOR	xmlsr
Uniform_Office_Text_Fmt	1369	1300	Uniform Office Format word processing document	application/vnd.uof.text	UOF, UOT	adWORDPROCESSOR	xmlsr
Uniform_Office_Spreadsheet_Fmt	1370	1301	Uniform Office Format spreadsheet	application/vnd.uof.spreadsheet	UOF, UOS	adSPREADSHEET	
Uniform_Office_Presentation_Fmt	1371	1302	Uniform Office Format presentation	application/vnd.uof.presentation	UOF, UOP	adPRESENTATION	

Format Name	Number	Category	Description	MIME Type	Extension	File Class	Readers
Uniform_Office_Zip_Fmt	1372	1303	Uniform Office Format document, zip format		UOF	adWORDPROCESSOR	
Uniform_Office_Text_Zip_Fmt	1373	1304	Uniform Office Format word processing document, zip format	application/vnd.uof.text+zip	UOF, UOT	adWORDPROCESSOR	
Uniform_Office_Spreadsheet_Zip_Fmt	1374	1305	Uniform Office Format spreadsheet, zip format	application/vnd.uof.spreadsheet+zip	UOF, UOS	adSPREADSHEET	
Uniform_Office_Presentation_Zip_Fmt	1375	1306	Uniform Office Format presentation, zip format	application/vnd.uof.presentation+zip	UOF, UOP	adPRESENTATION	
MacDraft_Fmt	1376	1307	MacDraft drawing		DRW, MDD	adCAD	
RagTime_Fmt	1377	1308	RagTime document		RAG, RTD	adDESKTOPPUBLISH	
MacDraw_Fmt	1378	1309	MacDraw drawing			adVECTORGRAPHIC	
Wingz_Fmt	1379	1310	Wingz spreadsheet		WKZ	adSPREADSHEET	
Claris_Draw_Fmt	1380	1311	Claris Draw document			adVECTORGRAPHIC	
BeagleWorks_Word_Fmt	1381	1312	BeagleWorks (later WordPerfect Works) Word Processor document		BW, WPW	adWORDPROCESSOR	stringsr
BeagleWorks_Database_Fmt	1382	1313	BeagleWorks (later WordPerfect Works) Database document		BW, WPW	adDATABASE	
BeagleWorks_Spreadsheet_Fmt	1383	1314	BeagleWorks (later WordPerfect Works) Spreadsheet document		BW, WPW	adSPREADSHEET	
BeagleWorks_Paint_Fmt	1384	1315	BeagleWorks (later WordPerfect Works) Paint document		BW, WPW	adRASTERIMAGE	
BeagleWorks_Draw_Fmt	1385	1316	BeagleWorks (later WordPerfect Works) Draw document		BW, WPW	adVECTORGRAPHIC	
GreatWorks_Word_Fmt	1386	1317	Symantec GreatWorks Word Processor document			adWORDPROCESSOR	stringsr
GreatWorks_Outline_Fmt	1387	1318	Symantec GreatWorks Outline document			adOUTLINE	
GreatWorks_Database_Fmt	1388	1319	Symantec GreatWorks Database document			adDATABASE	
GreatWorks_	1389	1320	Symantec GreatWorks			adSPREADSHEET	

Format Name	Number	Category	Description	MIME Type	Extension	File Class	Readers
Spreadsheet_Fmt			Spreadsheet document				
GreatWorks_Draw_Fmt	1390	1321	Symantec GreatWorks Draw document			adVECTORGRAPHIC	
GreatWorks_Chart_Fmt	1391	1322	Symantec GreatWorks Chart document			adVECTORGRAPHIC	
MS_Works_3_Mac_WP_Fmt	1392	1323	Microsoft Works for Mac, version 3 and 4, Word Processor document	application/x-msworks	MSW, WPS	adWORDPROCESSOR	
MS_Works_3_Mac_DB_Fmt	1393	1324	Microsoft Works for Mac, version 3 and 4, Database	application/x-msworks	WDB	adDATABASE	
MS_Works_3_Mac_SS_Fmt	1394	1325	Microsoft Works for Mac, version 3 and 4, Spreadsheet	application/x-msworks	WKS	adSPREADSHEET	
MS_Works_3_Mac_Comm_Fmt	1395	1326	Microsoft Works for Mac, version 3 and 4, Communications document	application/x-msworks		adCOMMUNICATION	
MS_Works_3_Mac_Draw_Fmt	1396	1327	Microsoft Works for Mac, version 3 and 4, Draw document	application/x-msworks	MSW	adVECTORGRAPHIC	
SAP_VDS_Fmt	1397	1328	SAP 3d Visual Enterprise VDS document		VDS	adCAD	
ZIPVFS_Fmt	1398	1329	ZIPVFS SQLite compressed read/write database		SQLITE	adDATABASE	
Right_Hemisphere_Material_Fmt	1399	1330	Right Hemisphere Material file		RH, RHM	adCAD	
RH_Thumbnails_Fmt	1400	1331	Right Hemisphere thumbnail collection file		\$RH	adCAD	
Westwood_Studios_Audio_Fmt	1401	1332	Westwood Studios Audio file		AUD	adSOUND	
Shockwave_Stream_Fmt	1402	1333	Shockwave Stream audio-video file		STREAM	adMOVIE	
EGG_Video_Fmt	1403	1334	EGG video file		EGG	adMOVIE	
IRCAM_Fmt	1404	1335	IRCAM audio file		IRCAM	adSOUND	
Sierra_Audio_Fmt	1405	1336	Sierra Entertainment audio file		SOL	adSOUND	

Format Name	Number	Category	Description	MIME Type	Extension	File Class	Readers
TiVo_Video_Fmt	1406	1337	TiVo video		TY+	adMOVIE	
OptimFROG_Fmt	1407	1338	OptimFROG audio		OFR, OFS	adSOUND	
LPAC_Fmt	1408	1339	Lossless Predictive Audio Compression file		PAC	adSOUND	
RK_Audio_Fmt	1409	1340	RK Audio lossless compressed audio		RKA	adSOUND	
Asylum_Music_Fmt	1410	1341	Asylum Music Format		AMF	adSOUND	
Novastorm_Audio_Fmt	1411	1342	Novastorm Media audio file		SMP	adSOUND	
HHE_Fmt	1412	1343	HHE video		HHE	adMOVIE	
Portable_Voice_Fmt	1413	1344	Portable Voice Format audio		PVF	adSOUND	
CNM_Video_Fmt	1414	1345	Arxel CNM audio-video format		CNM	adMOVIE	
Phantom_Cine_Fmt	1415	1346	Phantom Cine video file		CINE	adMOVIE	
MPEG2_Transport_Stream_Fmt	1416	1347	MPEG-2 Transport Stream video		M2TS	adMOVIE	
Audacity_Project_Fmt	1417	1348	Audacity audio project file	application/x-audacity-project	AUP	adSOUND	
Voltage_VSF_Fmt	1418	1349	Micro Focus Voltage VSF encrypted file		VDF	adENCAPSULATION	
XLIFF_Fmt	1419	1350	XML Localization Interchange File Format (XLIFF)	application/xliff+xml	XLF	adWORDPROCESSOR	xmlsr
XBRL_Fmt	1420	1351	Extensible Business Reporting Language (XBRL)		XBRL	adWORDPROCESSOR	xmlsr
AuditXPressX_Fmt	1421	1352	AuditXPressX file		AXPX	adWORDPROCESSOR	
Box_Note_Fmt	1422	1353	Box Note document		BOXNOTE	adWORDPROCESSOR	
Hikvision_DVR_Fmt	1423	1354	Hikvision DVR video			adMOVIE	
Electronic_Arts_TGV_Fmt	1424	1355	Electronic Arts TGV video		TGV	adMOVIE	
Electronic_Arts_TGQ_Fmt	1425	1356	Electronic Arts TGQ video		TGQ	adMOVIE	
Reaper_Video_Fmt	1426	1357	Reaper Video		FMV	adMOVIE	

Format Name	Number	Category	Description	MIME Type	Extension	File Class	Readers
Lightweight_Video_Fmt	1427	1358	Lightweight Video Format (LVF)		LVF	adMOVIE	
Liquid_Audio_Fmt	1428	1359	Liquid Audio		LQT	adSOUND	
Extended_Instrument_Fmt	1429	1360	eXtended Instrument generic audio tracker		XI	adSOUND	
MAML_Fmt	1430	1361	Microsoft Assistance Markup Language		AML	adWORDPROCESSOR	xmlsr
MS_Chat_Character_Fmt	1431	1362	Microsoft Comic Chat Character		AVB	adRASTERIMAGE	
MS_Border_Fmt	1432	1363	Microsoft Office Border images		BDR	adRASTERIMAGE	
MS_Binary_Log_Fmt	1433	1364	Microsoft Binary Log file		BLG	adMISC	
MS_Reader_eBook_Fmt	1434	1365	Microsoft Reader eBook file		LIT	adWORDPROCESSOR	
MS_Reader_Annotations_Fmt	1435	1366	Microsoft Reader annotation file		EBO	adWORDPROCESSOR	
Amazon_KFX_Aux_Fmt	1436	1367	Amazon KFX eBook auxiliary format (2015)		KFX, AZW	adWORDPROCESSOR	
Amazon_KFX_Ion_Fmt	1437	1368	Amazon KFX eBook Ion format (2015)		KFX, AZW, ION	adWORDPROCESSOR	
MS_DPAPI_Fmt	1438	1369	Microsoft Data Protection API (DPAPI) data			adMISC	
MS_Streets_Fmt	1439	1370	Microsoft Streets & Trips map		EST	adGIS	
MS_Fast_Find_Index_Fmt	1440	1371	Microsoft Office Fast Find Index		FFX	adMISC	
MS_Fresh_Paint_Fmt	1441	1372	Microsoft Fresh Paint image		FPPX	adRASTERIMAGE	
MS_Mathematics_Fmt	1442	1373	Microsoft Mathematics worksheet		GCW	adSCIENTIFIC	
MS_Instrument_Definition_Fmt	1443	1374	Microsoft MIDI Instrument Definition File		IDF	adSOUND	
MS_Pocket_Streets_Fmt	1444	1375	Microsoft Pocket Streets map		MPS	adGIS	
Obfuscated_OpenType_Fmt	1445	1376	Obfuscated OpenType font (ODTTF)	application/vnd.ms-package.obfuscated-opentype	ODTTF	adFONT	

Format Name	Number	Category	Description	MIME Type	Extension	File Class	Readers
Pfaff_PCS_Fmt	1446	1377	Pfaff PCS embroidery image		PCS	adVECTORGRAPHIC	
Janome_JEF_Fmt	1447	1378	Janome JEF embroidery format		JEF	adVECTORGRAPHIC	
Husqvarna_HUS_Fmt	1448	1379	Husqvarna Viking HUS embroidery format		HUS	adVECTORGRAPHIC	
Husqvarna_VIP_Fmt	1449	1380	Husqvarna Viking-Pfaff VIP embroidery format		VIP	adVECTORGRAPHIC	
Brother_PEC_Fmt	1450	1381	Brother PEC embroidery format		PEC	adVECTORGRAPHIC	
Brother_PES_Fmt	1451	1382	Brother PEC embroidery format		PES	adVECTORGRAPHIC	
Viking_SHV_Fmt	1452	1383	Viking SHV embroidery format		SHV	adVECTORGRAPHIC	
VP3_Fmt	1453	1384	VP3 embroidery format		VP3	adVECTORGRAPHIC	
SEW_Fmt	1454	1385	SEW embroidery format		SEW	adVECTORGRAPHIC	
Data_Stitch_Tajima_Fmt	1455	1386	Data Stitch Tajima (DST) embroidery image		DST	adVECTORGRAPHIC	
Singer_XXX_Fmt	1456	1387	Singer XXX embroidery image		XXX	adVECTORGRAPHIC	
Bernina_ART_Fmt	1457	1388	Bernina ART embroidery image		ART	adVECTORGRAPHIC	
MS_Prefetch_Fmt	1458	1389	Microsoft Windows Prefetch (uncompressed) file		PF	adMISC	
MS_Prefetch_Compresed_Fmt	1459	1390	Microsoft Windows Prefetch (compressed) file		PF	adMISC	
MS_MapPoint_Fmt	1460	1391	Microsoft MapPoint map		PTM	adGIS	
MS_Live_Meeting_Fmt	1461	1392	Microsoft Office Live Meeting Connection		RTC	adSCHEDULE	
MS_Speech_Definitions_Fmt	1462	1393	Microsoft text-to-speech Speech Definitions File		SDF	adMISC	
MS_Speech_Data_Fmt	1463	1394	Microsoft text-to-speech Speech Data File		SPD	adDATABASE	
MS_SQL_CE_Fmt	1464	1395	Microsoft SQL Server		SDF	adDATABASE	

Format Name	Number	Category	Description	MIME Type	Extension	File Class	Readers
			Compact (CE) edition database				
MS_ICE_Project_Fmt	1465	1396	Microsoft Image Composite Editor (ICE) Project		SPJ	adMISC	
MS_DVR_Fmt	1466	1397	Microsoft Digital Video Recording (DVR-MS)	video/x-ms-dvr	DVR-MS	adMOVIE	
Symbol_Dynamics_EXP_Fmt	1467	1398	Symbol Dynamics EXP document		WXP	adWORDPROCESSOR	stringsr
XNA_Compiled_Fmt	1468	1399	Microsoft XNA Compiled Format		XNB	adENCAPSULATION	
Outlook_Shortcut_Fmt	1469	1400	Microsoft Outlook or Exchange folder shortcut		XNK	adMISC	
ChiWriter_Fmt	1470	1401	ChiWriter document (up to version 3)		CHI	adWORDPROCESSOR	
ChiWriter4_Fmt	1471	1402	ChiWriter document (version 4)		CHI	adWORDPROCESSOR	
Lightning_Strike_Fmt	1472	1403	Lightning Strike image	image/cis-cod	COD	adRASTERIMAGE	
Blackberry_Executable_Fmt	1473	1404	Blackberry executable		COD	adEXECUTABLE	
EndNote_Library_Fmt	1474	1405	EndNote Library (up to version 9)	application/x-endnote-library	ENL	adDATABASE	
EndNote_Library_X_Fmt	1475	1406	EndNote Library (version X onwards)		ENL, ENLX	adDATABASE	
EndNote_Filter_Fmt	1476	1407	EndNote Filter	application/x-puid-fmt-327	ENF	adDATABASE	
EndNote_Style_Fmt	1477	1408	EndNote Style	application/x-endnote-style	ENS	adDATABASE	
EndNote_Connection_Fmt	1478	1409	EndNote Connection	application/x-endnote-connect	ENZ	adDATABASE	
Camtasia_Recording_Fmt	1479	1410	Camtasia Recording		CAMREC	adMOVIE	
Camtasia_Project_Fmt	1480	1411	Camtasia XML Project		CAMPROJ	adWORDPROCESSOR	
TechSmith_Project_Fmt	1481	1412	TechSmith JSON Project		TSCPROJ	adWORDPROCESSOR	
ABIF_Fmt	1482	1413	Applied Biosystems Inc. Format (ABIF)		AB1, FSA	adSCIENTIFIC	
CIF_Fmt	1483	1414	Crystallographic	chemical/x-cif	CIF	adSCIENTIFIC	

Format Name	Number	Category	Description	MIME Type	Extension	File Class	Readers
			Information File				
Sibelius_Fmt	1484	1415	Sibelius musical score		SIB	adSOUND	
Geogebra_Worksheet_Fmt	1485	1416	Geogebra worksheet	application/vnd.geogebra.file	GGB	adSCIENTIFIC	
Geogebra_Tool_Fmt	1486	1417	Geogebra tool		GGT	adSCIENTIFIC	
Polynomial_Texture_Map_Fmt	1487	1418	Polynomial Texture Map (PTM)		PTM	adRASTERIMAGE	
Poly_Tracker_Fmt	1488	1419	Poly Tracker audio		PTM	adSOUND	
PC_Outline_Fmt	1489	1420	PC-Outline document		PCO	adWORDPROCESSOR	
Spline_Font_Database_Fmt	1490	1421	Spline Font Database (SFD) font		SFD	adFONT	
QuickTime_Image_Fmt	1491	1422	QuickTime (QTIF) image	image/x-quicktime	QTIF, QIF, QTI	adRASTERIMAGE	
XBin_Image_Fmt	1492	1423	XBin image		XB	adRASTERIMAGE	
Segmented_Hypergraphics_Fmt	1493	1424	MS Segmented Hypergraphics image		SHG	adRASTERIMAGE	
LEADTools_CMP_Fmt	1494	1425	LEADTools CMP image		CMP	adRASTERIMAGE	
WBMP_Fmt	1495	1426	Wireless Bitmap image (WBMP)	image/vnd.wap.wbmp	WBMP	adRASTERIMAGE	
Blender_Fmt	1496	1427	Blender (v2) CAD file	application/x-blender	BLEND	adCAD	
Blender_v1_Fmt	1497	1428	Blender (v1) CAD file	application/x-blender	BLEND	adCAD	
Scribus_Fmt	1498	1429	Scribus document	application/vnd.scribus	SLA	adDESKTOPPUBLSH	
LyX_Fmt	1499	1430	LyX document	application/x-lyx	LYX	adWORDPROCESSOR	lyxsr
NZB_Fmt	1500	1431	NewzBin NZB format	application/x-nzb	NZB	adWORDPROCESSOR	
KWord_Fmt	1501	1432	KOffice KWord document	application/vnd.kde.kword	KWD	adWORDPROCESSOR	
KSpread_Fmt	1502	1433	KOffice KSpread document	application/vnd.kde.kspread	KSP	adSPREADSHEET	
KPresenter_Fmt	1503	1434	KOffice KPresenter document	application/vnd.kde.kpresenter	KPR	adPRESENTATION	
KWord_GZ_Fmt	1504	1435	KOffice (up to v1.1) kWord document	application/x-kword	KWD	adWORDPROCESSOR	
KSpread_GZ_Fmt	1505	1436	KOffice (up to v1.1) kSpread document	application/x-kspread	KSP	adSPREADSHEET	

Format Name	Number	Category	Description	MIME Type	Extension	File Class	Readers
KPresenter_GZ_Fmt	1506	1437	KOffice (up to v1.1) kPresenter document	application/x-kpresenter	KPR	adPRESENTATION	
Karbon_Fmt	1507	1438	KOffice Karbon document	application/vnd.kde.karbon	KARBON	adVECTORGRAPHIC	
KChart_Fmt	1508	1439	KOffice KChart document	application/vnd.kde.kchart	CHRT	adSPREADSHEET	
KPlato_Fmt	1509	1440	KOffice KPlato document	application/x-vnd.kde.kplato	KPLATO	adSCHEDULE	
GIMP_Pattern_Fmt	1510	1441	GIMP Pattern file		PAT	adRASTERIMAGE	
GIMP_Brush_Fmt	1511	1442	GIMP Brush file		GBR	adRASTERIMAGE	
GIMP_Animated_Brush_Fmt	1512	1443	GIMP Animated Brush file		GIH	adRASTERIMAGE	
Git_Pack_Index_Fmt	1513	1444	Git Pack Index format		IDX	adENCAPSULATION	
Git_Index_Fmt	1514	1445	Git Index format		INDEX	adENCAPSULATION	
MS_Tape_Fmt	1515	1446	Microsoft Tape Format		MTF, BAK	adENCAPSULATION	
STL_Binary_Fmt	1516	1447	3D Systems Stereolithography STL Binary Format			adCAD	
Unix_Shadow_Fmt	1517	1448	Unix /etc/shadow password file			adMISC	
MS_SQL_Log_Fmt	1518	1449	Microsoft SQL Server log		LDF	adDATABASE	
DER_Certificate_Fmt	1519	1450	DER-encoded X509 certificate	application/x-x509-user-cert	DER, CER	adENCAPSULATION	
EDIFACT_Fmt	1520	1451	EDIFACT-encoded EDI document	application/edifact	EDI	adDATABASE	
X12_Fmt	1521	1452	X12-encoded EDI document	application/edi-x12	EDI	adDATABASE	
Mathcad_Fmt	1522	1453	Mathcad MCD document	application/vnd.mcd	MCD	adSCIENTIFIC	
Mathcad_XML_Fmt	1523	1454	Mathcad XMCD document	application/x-mathcad	XMCD	adSCIENTIFIC	xmlsr
EDrawings_Fmt	1524	1455	eDrawings Publisher document		EASM, EPRT, EDRAW	adCAD	
First_Choice_DB_Fmt	1525	1456	PFS First Choice database	database/x-firstchoice	FOL	adDATABASE	
First_Choice_WP_Fmt	1526	1457	PFS First Choice word-processing document		DOC	adWORDPROCESSOR	
First_Choice_SS_Fmt	1527	1458	PFS First Choice spreadsheet	application/x-first-choice	SS	adSPREADSHEET	

Format Name	Number	Category	Description	MIME Type	Extension	File Class	Readers
Professional_Plan_Fmt	1528	1459	PFS Professional Plan spreadsheet	application/x-pfs-plan		adSPREADSHEET	
PFS_Write_Fmt	1529	1460	PFS Professional Write document	application/x-pfsprofessionalwrite	PFS	adWORDPROCESSOR	
Symantec_QA_Fmt	1530	1461	Symantec Q&A Database		DTF	adDATABASE	
Bitmap_Graphics_Array_Fmt	1531	1462	OS/2 Bitmap Graphics Array	image/bga	BGA, BMP, ICO	adRASTERIMAGE	
OS2_Help_Fmt	1532	1463	OS/2 Help/INF document		HLP, INF	adWORDPROCESSOR	
Frame_Vector_Fmt	1533	1464	Frame Vector Metafile		FMV	adVECTORGRAPHIC	
RBase_2_Fmt	1534	1465	R:Base database (v2-v4)		RBF	adDATABASE	
Harvard_Graphics_Symbol2_Fmt	1535	1466	Harvard Graphics Symbol File (v2)		SYM	adVECTORGRAPHIC	
Freelance_Graphics_Fmt	1536	1467	Lotus Freelance Graphics image		DRW	adRASTERIMAGE	
Snoop_Capture_Fmt	1537	1468	Snoop Packet Capture file		CAP, SNOOP	adENCAPSULATION	
Python_Pickle_Fmt	1538	1469	Python Pickle file		PICKLE, PKL, P	adEXECUTABLE	
Matlab_Pcode_Fmt	1539	1470	Matlab P-code file		P	adSOURCECODE	
Rhinoceros_3D_Fmt	1540	1471	Rhinoceros 3D Model		3DM	adCAD	
GL_Transmission_Binary_Fmt	1541	1472	Graphics Language (GL) Binary Transmission Format	model/gltf+binary	GLB	adCAD	
CAD_3DXML_Fmt	1542	1473	3DVIDIA 3DXML archive	application/x-3dxmlplugin	3DXML	adCAD	
CAD_3DXML_XML_Fmt	1543	1474	3DVIDIA 3DXML XML document		3DXML	adCAD	
Autodesk_Fusion_360_Fmt	1544	1475	Autodesk Fusion 360 model		F3D	adCAD	
DELFTship_Fmt	1545	1476	DELFTship or FREE!ship model		FBM	adCAD	
Autodesk_Inventor_Drawing_Fmt	1546	1477	Autodesk Inventor drawing		IDW	adCAD	
Autodesk_Inventor_Part_Fmt	1547	1478	Autodesk Inventor part		IPT	adCAD	
Autodesk_Inventor_Assembly_Fmt	1548	1479	Autodesk Inventor assembly		IAM	adCAD	

Format Name	Number	Category	Description	MIME Type	Extension	File Class	Readers
Autodesk_Revit_Fmt	1549	1480	Autodesk Revit document		RVT, RFA, RTE, RFT	adCAD	
FreeCAD_Fmt	1550	1481	FreeCAD document		FCSTD	adCAD	
Solid_Edge_Part_Fmt	1551	1482	Solid Edge part		PAR	adCAD	
Solid_Edge_Assembly_Fmt	1552	1483	Solid Edge assembly		ASM	adCAD	
Solid_Edge_SheetMetal_Fmt	1553	1484	Solid Edge sheet metal		PSM	adCAD	
SolidWorks_Visualize_Project_Fmt	1554	1485	SolidWorks Visualize project		SVPJ	adCAD	
Apache_Parquet_Fmt	1555	1486	Apache Parquet document		PARQUET	adDATABASE	parquetr
AES_Crypt_Fmt	1556	1487	AES Crypt document		AES	adENCAPSULATION	
SO_Math_XML_Fmt	1557	1488	OpenDocument format (OpenOffice 1/StarOffice 6,7) Math XML	application-vnd.sun.xml.math	SXM	adMISC	
MathML_Fmt	1558	1489	MathML document	application/mathml+xml	MML, MATHML	adMISC	
Photoshop_Brush_Fmt	1559	1490	Adobe Photoshop Brush document	image/x-adobe-photoshop-brush	ABR	adMISC	
Photoshop_Color_Book_Fmt	1560	1491	Adobe Photoshop Color Book		ACB	adMISC	
Premiere_Project_Fmt	1561	1492	Adobe Premiere Elements/Pro project		PRPROJ, PREL	adMISC	
Premiere_Title_Fmt	1562	1493	Adobe Premiere title document		PTL	adMISC	
Premiere_Pro_Title_Fmt	1563	1494	Adobe Premiere Pro title document		PRTL	adMISC	
Memgraph_Fmt	1564	1495	Memgraph database plist format	application/x-bplist-memgraph	MEMGRAPH	adDATABASE	
Memgraph_XML_Fmt	1565	1496	Memgraph database XML format		MEMGRAPH	adDATABASE	
AV1_Image_Fmt	1566	1497	AV1 Image Format (AVIF)	image/avif	AVIF	adRASTERIMAGE	
AV1_Image_Sequence_Fmt	1567	1498	AV1 Image Sequence Format (AVIFS)	image/avif-sequence	AVIFS	adANIMATION	
IVF_Fmt	1568	1499	IVF container document		IVF	adRASTERIMAGE	

Format Name	Number	Category	Description	MIME Type	Extension	File Class	Readers
AV1_Image_IVF_Fmt	1569	1500	AV1 Image (IVF container)	image/avif	AVIF, AVIFS	adRASTERIMAGE	
VP8_IVF_Fmt	1570	1501	VP8 Video (IVF container)		VP8	adMOVIE	
HPROF_Fmt	1571	1502	HPROF Java Profiler document	application/vnd.java.hprof	HPROF	adMISC	
XLIFF_Compressed_Fmt	1572	1503	XML Localization Interchange File Format compressed (XLIFF)	application/xliff+zip	XLZ	adWORDPROCESSOR	
Scenarist_Caption_Fmt	1573	1504	Scenarist Closed Caption document		SCC	adWORDPROCESSOR	
SubRip_Text_Fmt	1574	1505	SubRip Text (STT) subtitles document		SRT	adWORDPROCESSOR	
EBU_Subtitling_Fmt	1575	1506	EBU Subtitling data exchange format		STL	adWORDPROCESSOR	
Apache_ORC_Fmt	1576	1507	Apache ORC (Optimized Row Columnar) data		ORC	adDATABASE	
NES_Sound_Fmt	1577	1508	NES Sound File		NSF	adSOUND	
IW13_IWA_Fmt	1578	1509	Apple iWork 2013 IWA document		IWA	adMISC	
BioRad_Image_Fmt	1579	1510	BioRad confocal image		PIC	adSCIENTIFIC	
NIFTI_Fmt	1580	1511	NIFTI (NII) neuroimaging document		NII	adSCIENTIFIC	
MRC_DV_Fmt	1581	1512	MRC Deltavision (DV) / Priism image		DV	adSCIENTIFIC	
MRC_CCP4_Fmt	1582	1513	MRC CCP4 2014 image		MRC	adSCIENTIFIC	
ECAT_PET_Fmt	1583	1514	ECAT medical PET image		V	adSCIENTIFIC	
OME_XML_Fmt	1584	1515	Open Microscopy Environment (OME) XML document		XML	adSCIENTIFIC	
Panasonic_RAW_Fmt	1585	1516	Panasonic RAW or Leica RWL image	image/x-panasonic-raw	RAW, RWL	adRASTERIMAGE	
Panasonic_RW2_Fmt	1586	1517	Panasonic RW2 image	image/x-panasonic-rw2	RW2	adRASTERIMAGE	
FujiFilm_RAF_Fmt	1587	1518	FujiFilm RAF image	image/x-fuji-raf	RAF	adRASTERIMAGE	
Olympus_ORF_Fmt	1588	1519	Olympus ORF image	image/x-olympus-orf	ORF	adRASTERIMAGE	
HEVC_Fmt	1589	1520	High Efficiency Video	video/h265	HEVC, H265	adMOVIE	

Format Name	Number	Category	Description	MIME Type	Extension	File Class	Readers
			Coding (HEVC) MP4 document				
PAM_Fmt	1590	1521	Portable Arbitrary Map (PAM) image	image/x-portable-arbitrarymap	PAM	adRASTERIMAGE	
Paris_Audio_Fmt	1591	1522	Paris Audio Format		FAP, PAF	adSOUND	
Calendar_Creator_Fmt	1592	1523	Broderbund Calendar Creator document (v4+)		CC3, CE3, CC5, BCC	adSCHEDULE	
IWork_2013_Protected_Fmt	1593	1524	iWork 2013 password-protected document		PAGES, NUMBERS, KEY	adWORDPROCESSOR	
Corel_Wavelet_WVL_Fmt	1594	1525	Corel Wavelet WVL image		WVL	adRASTERIMAGE	
Corel_Wavelet_WI_Fmt	1595	1526	Corel Wavelet WI image		WI	adRASTERIMAGE	
Corel_Painter_RIF_Fmt	1596	1527	Corel Painter RIFF image		RIF	adRASTERIMAGE	
OmniPage_MET_Fmt	1597	1528	Caere OmniPage MET document		MET	adMISC	
OmniPage_OPD_Fmt	1598	1529	Caere OmniPage OPD document		OPD	adMISC	
GPS_Exchange_Fmt	1599	1530	GPS Exchange Format	application/gpx+xml	GPX	adGIS	
GL_Transmission_Fmt	1600	1531	GL Transmission Text Format	model/gltf+json	GLTF	adCAD	
CorelChart_Fmt	1601	1532	CorelChart document		CCH	adVECTORGRAPHIC	
LocoScript_PCW_Fmt	1602	1533	LocoScript document for Amstrad PCW			adWORDPROCESSOR	
LocoScript_DOS_Fmt	1603	1534	LocoScript document for MS-DOS			adWORDPROCESSOR	
IWork_2005_Protected_Fmt	1604	1535	iWork 2005-2009 password-protected document		PAGES, NUMBERS, KEY	adWORDPROCESSOR	
JAR_Pack_Fmt	1605	1536	Java Archive compressed with pack200	application/x-java-pack200	PACK	adENCAPSULATION	
GDIFF_Fmt	1606	1537	GDIFF (Generic Diff) document	application/gdiff		adMISC	
AFP_Fmt	1607	1538	IBM Advanced Function Presentation (AFP) image	application/vnd.ibm.modcap	AFP	adRASTERIMAGE	
NSIF_Fmt	1608	1539	NATO Secondary Image		NSF	adRASTERIMAGE	

Format Name	Number	Category	Description	MIME Type	Extension	File Class	Readers
			Format (NSIF) image				
XSL_FO_Fmt	1609	1540	XSL Formatting Object (XSL-FO)		FO, XSLFO	adWORDPROCESSOR	xmlsr
Consolidated_CDA_Fmt	1610	1541	Consolidated CDA document		XML	adWORDPROCESSOR	xmlsr
WebAssembly_Binary_Fmt	1611	1542	WebAssembly (WASM) binary-code	application/wasm	WASM	adEXECUTABLE	

¹MHT, EML, and MBX files might return either format 2, 233, or 395, depending on the text in the file. In general, files that contain fields such as **To**, **From**, **Date**, or **Subject** are considered to be email messages; files that contain fields such as **content-type** and **mime-version** are considered to be MHT files; and files that do not contain any of those fields are considered to be text files.

²All CAT file extensions, for example CATDrawing, CATProduct, CATPart, and so on.

³This format is returned only if you enable source code identification. See [Source Code Identification, on page 118](#).

⁴This format is returned only if you enable extended source code identification. See [Source Code Identification, on page 118](#).

Appendix B: Document Readers

This section lists the KeyView document readers that are available to filter, export, and view supported file formats.

- [Key to Document Readers Table](#) 392
- [Document Readers](#) 394

Key to Document Readers Table

The document readers table includes the following information.

Column	Description
Reader	The name of the reader.
Description	A description of the reader.
Filter	Shows whether KeyView can filter text from the main content of the file.
Export	Shows whether KeyView supports export to HTML, XML, and PDF.
View	Shows whether KeyView provides viewing capability.
Extract	Shows whether KeyView can extract sub-files.
Metadata	Shows whether KeyView can extract metadata (properties such as title, author, and subject).
Charset	Shows whether KeyView can detect and extract the character set. Even though a file format might be able to provide character set information, some documents might not contain character set information. Therefore, the document reader would not be able to determine the character set of the document.
H/F	Shows whether KeyView can extract headers and footers.
Associated File Formats	The file formats that are supported by the reader.

Key to Symbols

Symbol	Description
Y	The feature is supported.

Key to Symbols, continued

Symbol	Description
N	The feature is not supported.
P	Partial metadata is extracted from this format. Some non-standard fields are not extracted.
T	Only text is extracted from this format. Formatting information is not extracted.
M	Only metadata (title, subject, author, and so on) is extracted from this format. Text and formatting information are not extracted.

Document Readers

Reader	Description	Filter	Export	View	Extract	Metadata	Charset	H/F	Associated File Formats
ActiveX components	Microsoft Visio (2013)	N	N	Y ¹	N	Y	N	N	MS_Visio_2013_Fmt
ad1sr	AD1 Evidence file	N	N	Y	Y	N	n/a	N	AD1_Fmt
afmsr	Adobe Font Metrics	Y	T	T	N	N	N	N	Adobe_Font_Metrics_Fmt
afsr	ASCII Text	Y	Y	Y	N	N	N	N	ABAP_Fmt , AMPL_Fmt , APL_Fmt , ASCII_Text_Fmt , ASN1_Fmt , ATS_Fmt , Agda_Fmt , Alloy_Fmt , Apex_Fmt , AppleScript_Fmt , Arduino_Fmt , AsciiDoc_Fmt , AspectJ_Fmt , Assembly_Fmt , Awk_Fmt , BlitzMax_Fmt , Bluespec_Fmt , Brainfuck_Fmt , Brightscript_Fmt , CLIPS_Fmt , CMake_Fmt , COBOL_Fmt , CPlusPlus_Fmt , CWeb_Fmt , C_Fmt , CartoCSS_Fmt ,

¹Visio 2013 is supported in Viewing only, with the support of ActiveX components from the Microsoft Visio 2013 Viewer. Image fidelity is supported but other features, such as highlighting, are not.

Reader	Description	Filter	Export	View	Extract	Metadata	Charset	H/F	Associated File Formats
									Ceylon_Fmt , Chapel_Fmt , Clarion_Fmt , Clean_Fmt , Clojure_Fmt , CoffeeScript_Fmt , Component_Pascal_Fmt , Cool_Fmt , Coq_Fmt , Creole_Fmt , Crystal_Fmt , Csharp_Fmt , Csound_Document_Fmt , Csound_Fmt , Css_Fmt , Cuda_Fmt , DIGITAL_Command_Language_Fmt , DTrace_Fmt , D_Fmt , Dart_Fmt , Dockerfile_Fmt , ECL_Fmt , E_Fmt , Eiffel_Fmt , Elm_Fmt , Emacs_Lisp_Fmt , EmberScript_Fmt , Erlang_Fmt , Fantom_Fmt , Forth_Fmt , Fortran_Fmt , FreeMarker_Fmt , Frege_Fmt , Fsharp_Fmt , GAMS_Fmt , GAP_Fmt , GDScript_Fmt , GIS_World_File_Fmt , GLSL_Fmt , G_code_Fmt , Game_Maker_Language_Fmt , Gnuplot_Fmt , Go_Fmt , Golo_Fmt , Gosu_Fmt , Gradle_Fmt , GraphQL_Fmt , Graphviz_DOT_Fmt , Groovy_Fmt , HLSL_Fmt , Hack_Fmt , Haml_Fmt , Handlebars_Fmt , Haskell_Fmt , Hy_Fmt , IDL_Fmt , IGOR_Pro_Fmt , Idris_Fmt , Inform_7_Fmt , Ini_Fmt , Ioke_Fmt , Isabelle_Fmt , JSONiq_Fmt , JSX_Fmt , J_Fmt , Jasmin_Fmt , Java_Fmt , Javascript_Fmt , Jolie_Fmt , Julia_Fmt , KiCad_Layout_Fmt , KiCad_Schematic_Fmt , Kotlin_Fmt , LFE_Fmt , LOLCODE_Fmt , Lasso_Fmt , Limbo_Fmt , Lisp_Fmt , LiveScript_Fmt , Lua_Fmt , MAXScript_

Reader	Description	Filter	Export	View	Extract	Metadata	Charset	H/F	Associated File Formats
									Fmt , ML_Fmt , MSDOS_Batch_File_Fmt , M_Fmt , Makefile_Fmt , Markdown_Fmt , Mathematica_Fmt , Matlab_Fmt , Max_Code_Fmt , Mercury_Fmt , Modelica_Fmt , Modula_2_Fmt , Monkey_Fmt , Moocode_Fmt , NL_Fmt , NSIS_Fmt , NetLogo_Fmt , NewLisp_Fmt , Nginx_Fmt , Nix_Fmt , Nu_Fmt , OCaml_Fmt , ObjC_Fmt , ObjCpp_Fmt , ObjJ_Fmt , OpenCL_Fmt , OpenEdge_ABL_Fmt , OpenSCAD_Fmt , Ox_Fmt , Oxygene_Fmt , Oz_Fmt , PAWN_Fmt , PHP_Fmt , PLSQL_Fmt , PLpgSQL_Fmt , Pan_Fmt , Parrot_Assembly_Fmt , Pascal_Fmt , Perl_Fmt , PicoLisp_Fmt , Pike_Fmt , Pony_Fmt , Powershell_Fmt , Processing_Fmt , Prolog_Fmt , Puppet_Fmt , PureBasic_Fmt , Python_Fmt , QMake_Fmt , RAML_Fmt , RDoc_Fmt , REXX_Fmt , R_Fmt , Racket_Fmt , Ragel_Fmt , Rascal_Fmt , Rebol_Fmt , Red_Fmt , RenPy_Fmt , RenderScript_Fmt , Ring_Fmt , RobotFramework_Fmt , Ruby_Fmt , Rust_Fmt , SAS_Fmt , SGML_Fmt , SPARQL_Fmt , SQLPL_Fmt , SQL_Fmt , SaltStack_Fmt , Scala_Fmt , Scheme_Fmt , Scilab_Fmt , Scribe_Fmt , Shell_Fmt , Smalltalk_Fmt , Squirrel_Fmt , Stan_Fmt , Stata_Fmt , Stylus_Fmt , SuperCollider_Fmt , Swift_Fmt , SystemVerilog_Fmt , TSV_Fmt , TSV_Fmt , TXL_Fmt , Tcl_Fmt , Tex_Fmt ,

Reader	Description	Filter	Export	View	Extract	Metadata	Charset	H/F	Associated File Formats
									Turing_Fmt , Turtle_Fmt , TypeScript_Fmt , UrWeb_Fmt , Verilog_Fmt , Vim_script_Fmt , Visual_Basic_Fmt , WebAssembly_Fmt , WebIDL_Fmt , Wiki_Fmt , X10_Fmt , XQuery_Fmt , Xojo_Fmt , Xtend_Fmt , YAML_Fmt , YANG_Fmt , Zephir_Fmt , eC_Fmt , reStructuredText_Fmt , xBase_Fmt
aiffsr	Audio Interchange File Format	M	N	N	N	Y	N	N	AIFF_Fmt
asfsr	Advanced Systems Format (1.2)	N	N	N	N	Y	N	N	ASF_Fmt , WMA_Fmt , WMV_Fmt
assr	Applix Spreadsheets (4.2, 4.3, 4.4)	Y	Y	Y	N	N	Y	N	Applix_Spreadsheets_Fmt
avrosr	Apache Avro binary format	Y	N	N	N	N	N	N	Avro_Fmt
awsr	Applix Words (3.11, 4, 4.1, 4.2, 4.3, 4.4)	Y	Y	Y	N	N	Y	Y	Applix_Words_Fmt
axsr	Applix Asterix	Y	T	T	N	N	N	N	Applix_Alis_Fmt
b1sr	B1	N	N	Y	Y	N	n/a	N	B1_Fmt
bkfsr	Microsoft Backup File	N	N	Y	Y	N	n/a	N	BKF_Fmt
bmpsr	Windows Bitmap	M	M	N	N	Y	N	N	BMP_Fmt

Reader	Description	Filter	Export	View	Extract	Metadata	Charset	H/F	Associated File Formats
	Image								
bzip2sr	Bzip2 Compressed File	N	N	Y	Y	N	n/a	N	BZIP2_Fmt
cabsr	Microsoft Cabinet File (1.3)	N	N	Y	Y	N	n/a	N	CAB_Fmt
cdsr	Convergent Technologies DEF Comm. Format	Y	T	T	N	N	N	N	CT_DEF_Fmt
cebsr ¹	Founder Chinese E-paper Basic (3.2.1)	Y	N	N	N	N	N	N	Founder_CEB_Fmt
chmsr	Microsoft Compiled HTML Help (3)	N	N	Y	Y	N	n/a	N	CHM_Fmt
csvsr	CSV (Comma Separated Values)	Y	Y	Y	N	N	N	N	CSV_Fmt
dbfsr	dBase Database (III+, IV)	Y	Y	Y	N	N	N	N	dBase_Fmt
dbxsr	Microsoft Outlook Express DBX Message Database (5.0,	N	N	Y	Y	Y	Y	N	MS_OEDBX_Fmt

¹This reader is only supported on Windows 32-bit platforms.

Reader	Description	Filter	Export	View	Extract	Metadata	Charset	H/F	Associated File Formats
	6.0)								
dcasr	IBM DCA/RFT (Revisable Form Text) (SC23-0758-1)	Y	Y	Y	N	N	Y	N	DCA_RFT_Fmt
dcmsr	Digital Imaging & Communications in Medicine (DICOM)	M	N	N	N	Y	N	N	Dicom_Fmt
difsr	Data Interchange Format	Y	Y	Y	N	N	N	N	DIF_SpreadSheet_Fmt
dmgsr	Mac Disk Copy Disk Image	N	N	Y	Y	N	n/a	N	DMG_Fmt
dw4sr	DisplayWrite (4)	Y	Y	Y	N	N	Y	N	IBM_Display_Write_Fmt
dxlsr	IBM Domino Data in XML format ¹	N	N	Y	Y	Y	N	N	Lotus_Domino_DXL_Fmt
emlsr ²	Text Mail (MIME) / Microsoft Outlook Express (Windows 6, MacIntosh 5)	Y	T	T	Y	Y	Y	N	SMTP_Fmt

¹Supports non-encrypted embedded files only.

²This reader supports both clear signed and encrypted S/MIME. KeyView supports S/MIME for PST, EML, MBX, and MSG files.

Reader	Description	Filter	Export	View	Extract	Metadata	Charset	H/F	Associated File Formats
emxsr	Legato EMailXtender Archives	N	N	Y	Y	N	n/a	N	EMX_Fmt
encase2sr	Expert Witness Compression Format (EnCase) (7)	N	N	Y	Y	N	n/a	N	EnCase_Fmt
encasesr	Expert Witness Compression Format (EnCase) (6)	N	N	Y	Y	N	n/a	N	EnCase_Fmt
entsr	Microsoft Entourage Database (2004)	N	N	Y	Y	Y	Y	N	ENT_Fmt
epubsr	Open Publication Structure eBook (2.0, 3.0)	Y	Y	Y	N	Y	Y	N	Epub_Fmt , iBooks_Fmt
exesr	MSDOS/Windows Executable	N	N	Y	N	N	n/a	N	MS_Executable_Fmt
foliosr	Folio Flat File (3.1)	Y	Y	Y	N	Y	Y	Y	Folio_Flat_Fmt
gdsiisr	GDSII data format	Y	T	T	N	N	N	N	GDSII_Fmt
gifsr	GIF (87, 89)	M	M	N	N	Y	N	N	GIF_87a_Fmt , GIF_89a_Fmt
gwfssr	GroupWise FileSurf email	N	N	Y	Y	Y	N	N	GWFS_Email_Fmt
hl7sr	Health level7 message (2.0)	Y	Y	Y	N	Y	Y	N	HI7_Fmt

Reader	Description	Filter	Export	View	Extract	Metadata	Charset	H/F	Associated File Formats
htmsr	HTML/XHTML (3, 4)	Y	Y	Y	N	Y ¹	Y	N	HTML_Fmt , Netscape_Bookmark_File_Fmt
hwposr	Haansoft Hangul HWP (2002, 2005, 2007, 2010)	Y	Y	Y	Y	Y	Y	N	HWP_Fmt
hwpsr	Haansoft Hangul HWP (97)	Y	Y	Y	N	Y	Y	N	HWP_Fmt
hwpxsr	Haansoft Hangul HWPX	Y	T	T	N	N	Y	N	HWPX_Fmt
ichatsr	Apple iChat Log (1, AV 2, AV 2.1, AV 3)	Y	Y	Y	N	N	N	N	Apple_iChat_Fmt
icssr	Microsoft Outlook iCalendar (1.0, 2.0)	N	N	Y	Y	Y	Y	N	ICS_Fmt
isosr	ISO-9660 CD Disc Image	N	N	Y	Y	N	n/a	N	ISO_Fmt
iwss13sr ²	Apple iWork Numbers ('13, '16, '18, iCloud 2018)	Y	T	T	N	N	Y	N	IWSS13_Fmt
iwsssr	Apple iWork Numbers ('08, '09)	Y	Y	Y	N	Y	Y	N	IWSS_Fmt

¹HTML only supports partial metadata extraction

²This reader is available only on Windows (32-bit and 64-bit), Linux (32-bit and 64-bit), and Solaris x86-64.

Reader	Description	Filter	Export	View	Extract	Metadata	Charset	H/F	Associated File Formats
iwwp13sr ¹	Apple iWork Pages ('13, '16, '18, iCloud 2018)	Y	T	T	N	N	N	N	IWWP13_Fmt
iwwpsr	Apple iWork Pages ('08, '09)	Y	Y	Y	N	Y	Y	N	IWWP_Fmt
jp2000sr	JPEG (2000)	M	M	N	N	Y	N	N	ISO_JPEG2000_JP2_Fmt , ISO_JPEG2000_JPM_Fmt , ISO_JPEG2000_JPX_Fmt , JPEG_2000_JP2_File_Fmt , JPEG_2000_PGX_Fmt , Motion_JPEG_2000_Fmt
jpgsr	JPEG Interchange Format (JFIF)	M	M	N	N	Y	N	N	JPEG_File_Interchange_Fmt
jtdsr	JustSystems Ichitaro (8 to 2013, 2018)	Y	Y	Y	N	P	N	Y	ICHITARO_Compr_Fmt , ICHITARO_Fmt
kpagrdr	Applix Presents/Graphics (4.0, 4.2, 4.3, 4.4)	Y	Y	Y	N	N	N	N	Applix_Graphics_Fmt
kpanirdr	Windows Animated Cursor	N	Y	Y	N	N	N	N	Windows_Animated_Cursor_Fmt
kpbmprdr	Windows Bitmap Image	Y ²	Y	Y	N	N	N	N	BMP_Fmt

¹This reader is available only on Windows (32-bit and 64-bit), Linux (32-bit and 64-bit), and Solaris x86-64.

²Filtering is supported through OCR, which is only available on Windows 64-bit and Linux 64-bit platforms, and is licensed separately.

Reader	Description	Filter	Export	View	Extract	Metadata	Charset	H/F	Associated File Formats
kpCATrdr	CATIA formats (5)	Y	N	N	N	Y	N	N	CATIA_Fmt
kpcdrdr	CorelDRAW ¹ (through 9.0, 10, 11, 12, X3)	N	Y	Y	N	N	N	N	Corel_Draw_Fmt
kpcgmrdr ²	Computer Graphics Metafile	Y	Y	Y	N	N	N	N	CGM_Binary_Fmt , CGM_Character_Fmt , CGM_ClearText_Fmt
kpchtrdr	Microsoft Excel (2- 7) and Lotus 1-2-3 Charts (2-5)	N	Y	Y	N	N	N	N	
kpcxdrdr	DCX Fax System	N	Y	Y	N	N	N	N	DCX_Fmt
kpDWGrdr ³	Autodesk AutoCAD DWG Drawing (R13 onwards)	Y	Y	Y	N	Y	Y	N	AutoDesk_DWG_Fmt
kpDXFrdr ⁴	Autodesk AutoCAD DXF Drawing (R13 onwards)	Y	Y	Y	N	Y	Y	N	AutoCAD_DXF_Binary_Fmt , AutoCAD_DXF_Text_Fmt
kpemfrdr	Enhanced Metafile	Y	Y	Y	N	Y	N	N	Enhanced_Metafile_Fmt

¹CDR/CDR with TIFF header.

²Files with non-partitioned data are supported.

³The kpODArdr reader can filter, export, and view all versions but is supported only on Windows, Linux, and macOS. The kpDWGrdr reader is used on AIX, Solaris, and SPARC platforms, but does not support graphics for versions after 2004 or text for versions after 2013.

⁴The kpODArdr reader can filter, export, and view all versions but is supported only on Windows, Linux, and macOS. The kpDXFrdr reader is used on AIX, Solaris, and SPARC platforms, but does not support graphics for versions after 2004.

Reader	Description	Filter	Export	View	Extract	Metadata	Charset	H/F	Associated File Formats
kppepsrdr	Encapsulated PostScript (raster) (TIFF header)	N	Y	Y	N	N	N	N	EPSF_Fmt , Preview_EPSF_Fmt
kpGFLrdr	Omni Graffle	Y	N	N	N	Y	Y	N	Omni_Graffle_XML_Fmt
kpgifrdr	GIF (87, 89)	Y ¹	Y	Y	N	N	N	N	GIF_87a_Fmt , GIF_89a_Fmt
kpiconrdr	Windows Icon Cursor	N	Y	Y	N	N	N	N	Windows_Icon_Fmt
kpIWPG13rdr ²	Apple iWork Keynote ('13, '16, '18, iCloud 2018)	Y	T	N	N	N	N	N	IWPG13_Fmt
kpIWPGrdr	Apple iWork Keynote (2, 3, '08, '09)	Y	Y	Y	N	Y	Y	N	IWPG13_Fmt , IWPG_Fmt
kpJBIG2rdr	JBIG2	Y ³	Y	Y	N	N	N	N	JBIG2_Fmt
kpjp2000rdr	JPEG (2000)	Y ⁴	Y	Y	N	N	N	N	ISO_JPEG2000_JP2_Fmt , ISO_JPEG2000_JPM_Fmt , ISO_JPEG2000_JPX_Fmt , JPEG_2000_JP2_File_Fmt , JPEG_2000_PGX_Fmt , Motion_JPEG_2000_Fmt

¹Filtering is supported through OCR, which is only available on Windows 64-bit and Linux 64-bit platforms, and is licensed separately.

²This reader is available only on Windows (32-bit and 64-bit), Linux (32-bit and 64-bit), and Solaris x86-64.

³Filtering is supported through OCR, which is only available on Windows 64-bit and Linux 64-bit platforms, and is licensed separately.

⁴Filtering is supported through OCR, which is only available on Windows 64-bit and Linux 64-bit platforms, and is licensed separately.

Reader	Description	Filter	Export	View	Extract	Metadata	Charset	H/F	Associated File Formats
kpjpgdr	JPEG Interchange Format (JFIF)	Y ¹	Y	Y	N	N	N	N	JPEG_File_Interchange_Fmt
kpmacdr	MacPaint	N	Y	Y	N	N	N	N	MacPaint_Fmt
kpmsodr	Microsoft Office Drawing	N	Y	Y	N	N	N	N	MS_Office_Drawing_Fmt
kpODArdr	ODA	Y	Y	Y	N	Y	Y	N	AutoCAD_DXF_Binary_Fmt , AutoCAD_DXF_Text_Fmt , AutoDesk_DWG_Fmt
kpodfrdr	OASIS Open Document Format (1, 2 ²)	Y	Y	Y	Y ³	Y	Y	N	ODF_Drawing_Fmt , ODF_Drawing_Template_Fmt , ODF_Presentation_Fmt , ODF_Presentation_Template_Fmt , SO_Drawing_XML_Fmt , SO_Presentation_XML_Fmt
kpp40rdr	Microsoft PowerPoint (98)	Y	Y	Y	N	P ⁴	N	N	PowerPoint_Win_Fmt
kpp95rdr	Microsoft PowerPoint Windows (95)	Y	Y	Y	N	P	Y	N	PowerPoint_95_Fmt
kpp97rdr	Microsoft PowerPoint (97-	Y	Y	Y	N	P	Y	Y ⁵	PowerPoint_2000_Fmt , PowerPoint_97_Fmt

¹Filtering is supported through OCR, which is only available on Windows 64-bit and Linux 64-bit platforms, and is licensed separately.

²Generated by OpenOffice Impress 2.0, StarOffice 8 Impress, and IBM Lotus Symphony Presentation 3.0.

³Supported using the olesr embedded objects reader.

⁴Microsoft PowerPoint Windows only

⁵Microsoft PowerPoint Windows only

Reader	Description	Filter	Export	View	Extract	Metadata	Charset	H/F	Associated File Formats
	2004)								
kppctrdr	Macintosh Raster / QuickDraw (2)	N	Y	Y	N	N	N	N	Mac_PICT_Fmt
kppcxrdr	PC PaintBrush (3)	N	Y	Y	N	N	N	N	PC_Paintbrush_Fmt
kppdf2rdr ¹	Adobe PDF (1.1 to 1.7, 2.0)	N	N	Y	N	N	N	N	PDF_Fmt
kppdfdr	Adobe PDF (1.1 to 1.7, 2.0)	N	Y	Y	N	N	N	N	PDF_Fmt
kppicrdr	Lotus PIC	Y	Y	Y	N	N	N	N	Lotus_PIC_Fmt
kppngrdr	Portable Network Graphics	Y ²	Y	Y	N	N	N	N	APNG_Fmt , PNG_Fmt
kpppxrdr	Microsoft PowerPoint Windows XML (2007 onwards)	Y	Y	Y	Y	Y	Y	Y	MS_PPT_2007_Fmt , MS_PPT_Macro_2007_Fmt
kpprerdr	Lotus Freelance Graphics 2 (2)	Y	Y	Y	N	N	N	N	Freelance_OS2_Fmt , Freelance_Win_Fmt
kppzrdr	Lotus Freelance Graphics (96, 97, 98, R9, 9.8)	Y	Y	Y	N	N	N	N	Freelance_96_Fmt , Freelance_97_Fmt , Freelance_DOS_Fmt

¹kppdf2rdr is an alternate graphic-based reader that produces high-fidelity output but does not support other features such as highlighting or text searching.

²Filtering is supported through OCR, which is only available on Windows 64-bit and Linux 64-bit platforms, and is licensed separately.

Reader	Description	Filter	Export	View	Extract	Metadata	Charset	H/F	Associated File Formats
kpsddrdr	StarOffice Impress (3, 4, 5)	Y	T	N	N	N	N	N	SO_Presentation_Fmt
kpsdwrdr	Lotus AMIDraw Graphics	N	Y	Y	N	N	N	N	Ami_Pro_Draw_Fmt , SO_Text_Fmt
kpsgirdr	SGI RGB Image	N	Y	Y	N	N	N	N	SGI_Image_Fmt
kpshwrdr	Corel Presentations (6, 7, 8, 9, 10, 11, 12, X3)	Y	Y	Y	N	N	N	N	Corel_Presentations_Fmt
kpsunrdr	Sun Raster Image	N	Y	Y	N	N	N	N	Sun_Raster_Fmt
kpTGArdr	Truevision Targa (2)	N	Y	Y	N	N	N	N	Targa_Fmt
kptifdr	TIFF Tagged Image File (through 6.0 ¹)	Y ²	Y	Y	N	N	N	N	TIFF_Fmt
kpUGrdr	Unigraphics (UG) NX	Y	N	N	N	N	N	N	Unigraphics_NX_Fmt
kpVSD2rdr	Microsoft Visio (4,	Y	Y	Y	N	Y	Y	N	MS_Visio_Fmt

¹The following compression types are supported: no compression, CCITT Group 3 1-Dimensional Modified Huffman, CCITT Group 3 T4 1-Dimensional, CCITT Group 4 T6, LZW, JPEG (only Gray, RGB and CMYK color space are supported), and PackBits.

²Filtering is supported through OCR, which is only available on Windows 64-bit and Linux 64-bit platforms, and is licensed separately.

Reader	Description	Filter	Export	View	Extract	Metadata	Charset	H/F	Associated File Formats
	5, 2000, 2002, 2003, 2007, 2010 ¹)								
kpVSDXrdr	Microsoft Visio (2013)	Y	Y	Y	Y	Y	Y	N	MS_Visio_2013_Fmt , MS_Visio_2013_Macro_Fmt , MS_Visio_2013_Stencil_Fmt , MS_Visio_2013_Stencil_Macro_Fmt , MS_Visio_2013_Template_Fmt , MS_Visio_2013_Template_Macro_Fmt
kpwg2rdr	WordPerfect Graphics 2 (2, 7)	N	Y	Y	N	N	N	N	WordPerfect_Graphics_Fmt
kpwmfrdr	Windows Metafile (3)	Y ²	Y	Y	N	N	N	N	Windows_Metafile_Fmt , Windows_Metafile_NoHdr_Fmt
kpwpgrdr	WordPerfect Graphics 1 (1)	N	Y	Y	N	N	N	N	WordPerfect_Graphics_Fmt
kpXFDLrdr	Extensible Forms Description Language	Y	Y	Y	N	Y	Y	N	XFDL_Fmt
kvgz	GZIP archive (2)	N	N	Y	N	N	n/a	N	GZ_Compress_Fmt
kvgzsr	GZIP archive (2)	N	N	N	Y	N	n/a	N	GZ_Compress_Fmt

¹Viewing and Export use the graphic reader, kpVSD2rdr for Microsoft Visio 2003, 2007, and 2010, and vsdsr for all earlier versions. Image fidelity in Viewing and Export is therefore only supported for versions 2003 and above. Filter uses the graphic reader kpVSD2rdr for Microsoft Visio 2003, 2007, and 2010, and vsdsr for all earlier versions.

²Windows Metafiles can contain both raster images (KeyView file class 4) and vector graphics (KeyView file class 5). Filtering is supported only for vector graphics (class 5).

Reader	Description	Filter	Export	View	Extract	Metadata	Charset	H/F	Associated File Formats
kvhqsr	BinHex	N	N	Y	Y	N	n/a	N	BinHex_Fmt
kvzee	UNIX Compress	N	N	Y	N	N	n/a	N	Compress_Fmt
kvzeesr	UNIX Compress	N	N	N	Y	N	n/a	N	Compress_Fmt
l123sr	Lotus 1-2-3 (96, 97, R9, 9.8)	Y	Y	Y	N	P	Y	N	Lotus_123_97_Fmt , Lotus_123_Format_Fmt , Lotus_123_R9_Fmt
lasr	Lotus AMI Pro and Write Plus (2, 3)	Y	Y	Y	N	P ¹	Y ²	Y	Ami_Pro_Fmt , Ami_Pro_StyleSheet_Fmt
lwpsr ³	Lotus Word Pro and SmartMaster (96, 97, R9)	Y	Y	Y	N	P ⁴	N	Y ⁵	Lotus_Word_Pro_96_Fmt , Lotus_Word_Pro_97_Fmt
lyxsr	LyX Word Processor	Y	T	T	N	N	N	N	LyX_Fmt
lzhsr	Microsoft LZH Compressed Folder	N	N	N	Y	N	n/a	N	LZH_Fmt
macbinsr	MacBinary	N	N	Y	Y	N	n/a	N	MacBinary_Fmt
mbsr	Microsoft Word Macintosh (4, 5, 6,	Y	Y	Y	N	Y	N	Y	MS_Word_Mac_4_Fmt , MS_Word_Mac_Fmt

¹Lotus AMI Pro only

²Lotus AMI Pro only

³This reader is only available on Windows 32-bit

⁴Lotus Word Pro only

⁵Lotus Word Pro only

Reader	Description	Filter	Export	View	Extract	Metadata	Charset	H/F	Associated File Formats
	98)								
mbxsr ¹	Text Mail (MIME), Microsoft Outlook Express (Windows 6, Macintosh 5), Mailbox ² (Thunderbird 1.0, Eudora 6.2)	Y ³	N	T	Y	Y	Y	N	MIME_Fmt
MCI	Microsoft Media Control Interface	N	N	Y	N	N	N	N	AIFF_Fmt , AU_Audio_Fmt , ISO_QuickTime_Fmt , MIDI_Audio_Fmt , MPEG_Audio_Fmt , MS_Video_Fmt , MS_WAVE_Audio_Fmt , Mobile_QuickTime_Fmt , QuickTime_Fmt
mdbsr	Microsoft Access (95 onwards)	Y	T	T	N	N	Y ⁴	N	MS_Access_2000_Fmt , MS_Access_2007_Fmt , MS_Access_95_Fmt , MS_Access_97_Fmt , MS_Access_Fmt
mhtsr	MIME HTML (MHTML)	Y	Y	Y	N	Y	Y	N	MHT_Fmt
mifsr	Adobe FrameMaker	Y	Y	Y	N	N	Y	N	Maker_Interchange_Fmt

¹This reader supports both clear signed and encrypted S/MIME. KeyView supports S/MIME for PST, EML, MBX, and MSG files.

²KeyView supports MBX files created by Eudora Email and Mozilla Thunderbird. MBX files created by other common mail applications are typically filtered, converted, and displayed.

³Text Mail only

⁴Charset is not supported for Microsoft Access 95 or 97.

Reader	Description	Filter	Export	View	Extract	Metadata	Charset	H/F	Associated File Formats
	Interchange Format (5, 5.5, 6, 7)								
misr	Microsoft Word Windows (1.0, 2.0)	Y	Y	Y	N	N	N	Y	MS_Word_Win_Fmt
mp3sr	MPEG-1 Audio layer3 (ID3 v1 and v2)	M	M	Y	N	Y	N	N	MPEG_Audio_Fmt
mpeg4sr	MPEG video	M	N	N	N	Y	N	N	Adobe_Flash_Audio_Book_Fmt , Adobe_Flash_Audio_Fmt , Adobe_Flash_Protected_Video_Fmt , Adobe_Flash_Video_Fmt , Audible_Audiobook_Fmt , ISO_3GPP2_Fmt , ISO_3GPP_Fmt , ISO_IEC_MPEG_4_Fmt , KDDI_Video_Fmt , MPEG4_AVC_Fmt , MPEG4_M4A_Fmt , MPEG4_M4B_Fmt , MPEG4_M4P_Fmt , MPEG4_M4V_Fmt , MPEG4_Sony_PSP_Fmt , MPEG_21_Fmt , NTT_MPEG4_Fmt , Nero_MPEG4_Audio_Fmt , QuickTime_Fmt , Sony_XAVC_Fmt
mppsr	Microsoft Project (2000 onwards)	Y	Y	Y	Y	Y	Y	N	MS_Project_2000_Fmt , MS_Project_2007_Fmt , MS_Project_41_Fmt , MS_Project_4_Fmt , MS_Project_98_Fmt

Reader	Description	Filter	Export	View	Extract	Metadata	Charset	H/F	Associated File Formats
msgsr ¹	Microsoft Outlook (97 onwards), Documentum EMCMF	Y ²	T ³	Y ⁴	Y	Y	Y ⁵	N	EMCMF_Fmt , MS_Outlook_Fmt
mspubsr	Microsoft Publisher (98 to 2016)	Y	T	T	Y	Y	Y	N	MS_Publisher_98_Fmt , MS_Publisher_Fmt
msw6sr	Microsoft Works Word Processor for Windows (6, 2000)	Y	Y	Y	N	N	N	Y	MS_Works_Win_WP_Fmt
mswsr	Microsoft Works Word Processor for Windows (1, 2, 3, 4)	Y	Y	Y	N	N	N	Y	MS_Works_Win_WP_Fmt
multiarcsr ⁶	Compressed formats	N	N	Y ⁷	Y	N	n/a	N	ARJ_Fmt , RAR5_Fmt , XZ_Fmt
mw6sr	Microsoft Word for Windows (6, 7, 8,	Y	Y	Y	N	Y	Y	Y	MS_Word_95_Fmt

¹This reader supports both clear signed and encrypted S/MIME. KeyView supports S/MIME for PST, EML, MBX, and MSG files.

²Except Documentum EMCMF

³Except Documentum EMCMF

⁴For Outlook this is Text only

⁵Returns "Unicode" character set for Outlook version 2003 and up, and "Unknown" character set for previous versions.

⁶zip is supported with the multiarcsr reader on some platforms for Extract.

⁷zip and SUN PEX archives only

Reader	Description	Filter	Export	View	Extract	Metadata	Charset	H/F	Associated File Formats
	95)								
mw8sr	Microsoft Word (97-2004)	Y	Y	Y	Y ¹	Y	Y	Y ²	MS_Word_2000_Fmt , MS_Word_97_Fmt
mwsr	Microsoft Word PC (4-6) and Windows Write (1-3)	Y	Y	Y	N	N	Y ³	Y ⁴	MS_Windows_Write_Fmt , MS_Word_PC_Driver_Fmt , MS_Word_PC_Fmt , MS_Word_PC_Glossary_Fmt , MS_Word_PC_Misc_Fmt , MS_Word_PC_StyleSheet_Fmt
mwssr	Microsoft Works Spreadsheet (2, 3, 4)	Y	Y	Y	N	N	Y	N	MS_Works_DOS_SS_Fmt , MS_Works_Mac_SS_Fmt , MS_Works_Win_SS_Fmt
mwxsr	Microsoft Word XML (2007 onwards)	Y	Y	Y	Y	Y	Y	Y	MS_Word_2007_Flat_XML_Fmt , MS_Word_2007_Fmt , MS_Word_Macro_2007_Fmt
nnsr	NBI OASys Net Archive	Y	T	T	N	N	N	N	NBI_Net_Archive_Fmt
nsfsr	IBM Lotus Notes database (4, 5, 6.0, 6.5, 7.0, 8.0)	N	N	Y	Y	Y	N	N	Lotus_Notes_NSF_Fmt
oa2sr	Fujitsu Oasys (7)	Y	Y	Y	N	P	N	N	Oasys_Fmt

¹Supported using the embedded objects reader olesr.

²Microsoft Word for Windows only

³Microsoft Windows Write only

⁴Microsoft Word PC only

Reader	Description	Filter	Export	View	Extract	Metadata	Charset	H/F	Associated File Formats
odfsssr	OASIS Open Document Format (1, 2 ¹)	Y	Y	Y	Y ²	Y	Y	N	ODF_Spreadsheet_Fmt , ODF_Spreadsheet_Template_Fmt
odfwpsr	OASIS Open Document Format (1, 2 ³)	Y	Y	Y	Y ⁴	Y	Y	Y	ODF_Text_Fmt , ODF_Text_Master_Fmt , ODF_Text_Template_Fmt , ODF_Text_Web_Fmt , SO_Text_XML_Fmt
olesr	Windows Scrap File	N	N	N	Y	Y	n/a	N	Ability_WP_OLE_Fmt , Autodesk_3ds_Max_Fmt , Crystal_Reports_Fmt , FPX_Fmt , MS_AtWork_Fax_Fmt , MS_Binder_Fmt , MicroStation_V8_DGN_Fmt , OLE_Fmt , PageMagic_Fmt , PagePlus_Fmt , PhotoDraw_Mix_Fmt , PowerPoint_Mac_Fmt , SO_Chart_Fmt , SO_Database_Fmt , SO_Math_Fmt , Scrap_Fmt , SolidWorks_Fmt , Windows_Installer_Fmt , Windows_Installer_Patch_Fmt
olmsr	Microsoft Outlook for Macintosh (2011)	N	N	Y	Y	N	Y	N	MS_OutlookOLM_Fmt
onesr	Microsoft OneNote (2007, 2010, 2013, 2016)	Y	Y	Y	Y	N	Y	N	OneNote_Fmt

¹Generated by OpenOffice Calc 2.0, StarOffice 8 Calc, and IBM Lotus Symphony Spreadsheet 3.0.

²Supported using the embedded objects reader olesr.

³Generated by OpenOffice Writer 2.0, StarOffice 8 Writer, and IBM Lotus Symphony Documents 3.0.

⁴Supported using the embedded objects reader olesr.

Reader	Description	Filter	Export	View	Extract	Metadata	Charset	H/F	Associated File Formats
onealtsr	Microsoft OneNote Alternative Packaging Format (2007 onwards)	Y	T	T	Y	N	N	N	OneNote_Alternate_Fmt
onmsr	Legato Extender	N	N	Y	Y	Y	N	N	Legato_Extender_ONM_Fmt
oo3sr	Omni Outliner (v3, OPML, OOutline)	Y	Y	Y	N	N	Y	N	OO3_Fmt , OOUTLINE_Fmt , OPML_Fmt
parquetsr	Apache Parquet Database Format	Y ¹	N	N	N	Y ²	N	N	Apache_Parquet_Fmt
pbixsr	Microsoft Power BI Desktop (1.11)	Y	T	T	N	N	Y	N	MS_Power_BI_Fmt
pdf2sr	Adobe PDF (1.1 to 1.7, 2.0)	N	Y	N	N	N	N	N	PDF_Fmt
pdfsr	Adobe PDF (1.1 to 1.7, 2.0)	Y	Y	N	Y ³	Y	Y	N	PDF_Fmt , Portfolio_PDF_Fmt
pfasr	ASCII Printer and PostScript fonts	Y	T	T	N	N	N	N	PostScript_Font_Fmt , Printer_Font_ASCII_Fmt
pfcsr ⁴	Microsoft Outlook Offline Storage File (97 onwards)	N	N	Y	Y	Y	Y	N	MS_OutlookOST_Fmt

¹This reader is only supported on Windows 64-bit

²This reader is only supported on Windows 64-bit

³Includes support for extraction of subfiles from PDF Portfolio documents.

⁴The reader pfcsr is available only on Windows and Linux.

Reader	Description	Filter	Export	View	Extract	Metadata	Charset	H/F	Associated File Formats
pfilesr	Rights Management Services (RMS)-protected format	Y ¹	T ²	T ³	N	Y	N	N	RMS_Protected_Fmt
pkcs7sr ⁴	PKCS #7 cryptographic format	N	N	Y	Y	N	N	N	PKCS_7_Fmt
pngsr	Portable Network Graphics	M	M	N	N	Y	N	N	PNG_Fmt
psdsr	Adobe Photoshop	N	N	N	N	Y ⁵	N	N	PSD_Fmt
pstnsr	Microsoft Outlook Personal Folder ⁶ (97 onwards)	N	N	Y	Y	Y	Y	N	MS_OutlookPST_Fmt

¹KeyView filters only the internal redirection text. The underlying document text is not accessible without the decryption key.

²KeyView filters only the internal redirection text. The underlying document text is not accessible without the decryption key.

³KeyView filters only the internal redirection text. The underlying document text is not accessible without the decryption key.

⁴This reader supports PKCS #7 signed data only.

⁵Only XMP metadata is extracted for this format.

⁶KeyView provides several readers capable of processing PST files. The pstsr reader uses the Microsoft Messaging Application Programming Interface (MAPI), works only on Windows, and requires that you have Microsoft Outlook installed. The pstxsr reader is available for Windows (32-bit and 64-bit) and Linux (64-bit only) and does not require Microsoft Outlook. The pstnsr reader is an alternative reader that does not require Microsoft Outlook, for all platforms not supported by pstxsr. For more information about these readers, see "Extract Subfiles from Outlook Personal Folders Files" in Chapter 3.

Reader	Description	Filter	Export	View	Extract	Metadata	Charset	H/F	Associated File Formats
pstsr ¹	Microsoft Outlook Personal Folder ² (97 onwards)	N	N	Y	Y	Y	N	N	MS_OutlookPST_Fmt
pstxsr	Microsoft Outlook Personal Folder ³ (97 onwards)	N	N	Y	Y	Y	Y	N	MS_OutlookPST_Fmt
pwsr	PRIMEWORD	Y	T	T	N	N	N	N	PRIMEWORD_Fmt
qpssr	Corel Quattro Pro (5, 6, 7, 8)	Y	Y	Y	N	P	Y	N	Quattro_Pro_Win_Fmt
qpwsr	Corel Quattro Pro (X4)	Y	N	Y	N	P	Y	N	QPW_Fmt
rarsr	RAR archive (2.0 through 3.5)	N	N	N	Y	N	n/a	N	RAR_Fmt
riffsr	Microsoft Wave Sound	M	N	N	N	Y	N	N	MS_WAVE_Audio_Fmt

¹This reader supports both clear signed and encrypted S/MIME. KeyView supports S/MIME for PST, EML, MBX, and MSG files.

²KeyView provides several readers capable of processing PST files. The pstsr reader uses the Microsoft Messaging Application Programming Interface (MAPI), works only on Windows, and requires that you have Microsoft Outlook installed. The pstxsr reader is available for Windows (32-bit and 64-bit) and Linux (64-bit only) and does not require Microsoft Outlook. The pstnsr reader is an alternative reader that does not require Microsoft Outlook, for all platforms not supported by pstxsr. For more information about these readers, see "Extract Subfiles from Outlook Personal Folders Files" in Chapter 3.

³KeyView provides several readers capable of processing PST files. The pstsr reader uses the Microsoft Messaging Application Programming Interface (MAPI), works only on Windows, and requires that you have Microsoft Outlook installed. The pstxsr reader is available for Windows (32-bit and 64-bit) and Linux (64-bit only) and does not require Microsoft Outlook. The pstnsr reader is an alternative reader that does not require Microsoft Outlook, for all platforms not supported by pstxsr. For more information about these readers, see "Extract Subfiles from Outlook Personal Folders Files" in Chapter 3.

Reader	Description	Filter	Export	View	Extract	Metadata	Charset	H/F	Associated File Formats
rtfsr	Rich Text Format (1 through 1.7)	Y	Y	Y	N	P	Y	Y	MS_Pocket_Word_Fmt , MS_RTF_Fmt
sassr	SAS7BDAT reader	Y	T	T	N	N	N	N	SAS7BDAT_Fmt
skypesr	Skype Log (3)	Y	Y	Y	N	N	N	N	Skype_Fmt
sosr	OpenOffice, LibreOffice(1-5), StarOffice (6-9)	Y	T	T	N	Y	Y	N	SO_Spreadsheet_XML_Fmt
starcsr	StarOffice Calc (3, 4, 5)	Y	T	T	N	N	N	N	SO_Spreadsheet_Fmt
starwsr	StarOffice Writer (3, 4, 5)	Y	T	T	N	N	N	N	SO_Text_Fmt
stringssr	Generic 'strings' reader	Y	T	T	N	N	N	N	BeagleWorks_Word_Fmt , CEOwrite_Fmt , CPT_Comm_Fmt , CWK_Fmt , DG_CDS_Fmt , DSA101_Fmt , Data_Point_VistaWord_Fmt , Enable_WP_Fmt , GreatWorks_Word_Fmt , HP_Word_PC_Fmt , IBM_DCF_Script_Fmt , IBM_Writing_Assistant_Fmt , Lotus_Notes_CDF_Fmt , Lyrix_Fmt , MASS_11_Fmt , MS_Works_DOS_WP_Fmt , MS_Works_Mac_WP_Fmt , MacWrite_Fmt , MacWrite_II_Fmt , Multimate_Adv_Fmt , Multimate_Adv_Fnote_Fmt , Multimate_Adv_II_Fmt , Multimate_Adv_II_Fnote_Fmt , Multimate_Fmt , Multimate_Fnote_Fmt , Navy_DIF_Fmt , ODA_Q1_11_Fmt ,

Reader	Description	Filter	Export	View	Extract	Metadata	Charset	H/F	Associated File Formats
									ODA_Q1_12_Fmt , Office_Writer_Fmt , Psion_TextEd_Fmt , Psion_Word_3_Fmt , Psion_Word_Fmt , Q_A_DOS_Fmt , Q_A_Win_Fmt , Quadratron_Q_One_v1_Fmt , Quadratron_Q_One_v2_Fmt , Quickword_Fmt , SAMNA_Word_IV_Fmt , Symbol_Dynamics_EXP_Fmt , Targon_Word_Fmt , Uniplex_WP_Fmt , Volkswriter_Fmt , WANG_WITA_Fmt , WANG_WPS_Comm_Fmt , WPS_PLUS_Fmt , WordERA_Fmt , WordMARC_Fmt , WordPerfect_Fmt , WordStar_2000_Fmt , WordStar_Fmt , WordStar_for_Windows_Fmt , Word_Connection_Fmt , WriteNow_Fmt , Xerox_860_Comm_Fmt , Xerox_Writer_Fmt
swfsr	Macromedia Flash (through 8.0)	Y	Y	Y	N	N	Y ¹	N	Macromedia_Flash_Fmt
swsr	Informix SmartWare II Word Processor	Y	T	T	N	N	N	N	SmartWare_II_WP_Fmt
tarsr	TAR Tape Archive	N	N	Y	Y	N	n/a	N	TAR_Fmt
tifsr	TIFF Tagged Image File	M	M	N	N	Y	N	N	TIFF_Fmt

¹The character set cannot be determined for versions 5.x and lower.

Reader	Description	Filter	Export	View	Extract	Metadata	Charset	H/F	Associated File Formats
	(through 6.0 ¹)								
tnefsr	Transport Neutral Encapsulation Format	N	N	Y	Y	Y	Y	N	TNEF_Fmt
unihtmsr	Unicode HTML	Y	Y	Y	N	Y	Y	N	Unicode_HTML_Fmt
unizr	Unicode Text (3, 4)	Y	Y	Y	N	N	Y	N	Unicode_Fmt
unzip	PKZIP/Zip Compression	N	N	Y ²	Y	N	n/a	N	Executable_JAR_Fmt , KMZ_Fmt , ODF_Formula_Fmt , ODF_Formula_Template_Fmt , PKZIP_Fmt , Tableau_Packaged_Data_Source_Fmt , Tableau_Packaged_Workbook_Fmt
uudsr	UU-Encoding (all versions)	N	N	Y	Y	N	n/a	N	UUEncoded_Fmt
vcfsr	Microsoft Outlook vCard Contact (2.1, 3.0, 4.0)	Y	Y	T	N	Y	N	N	VCF_Fmt
vsdsr	Microsoft Visio (4, 5, 2000, 2002,	Y	Y	Y	Y ⁴	Y	Y	N	MS_Visio_Fmt

¹The following compression types are supported: no compression, CCITT Group 3 1-Dimensional Modified Huffman, CCITT Group 3 T4 1-Dimensional, CCITT Group 4 T6, LZW, JPEG (only Gray, RGB and CMYK color space are supported), and PackBits.

²PKZIP, WinZip, and Java Archive only

⁴Extraction of embedded OLE objects is supported for Filter on Windows platforms only.

Reader	Description	Filter	Export	View	Extract	Metadata	Charset	H/F	Associated File Formats
	2003, 2007, 2010 ¹)								
wkssr	Lotus 1-2-3 (2, 3, 4, 5)	Y	Y	Y	N	N	Y	N	Lotus_123_Worksheet_Fmt
wosr	Corel WordPerfect Windows (5, 5.1)	Y	Y	Y	N	P	Y	Y	WordPerfect_5_Fmt
wp6sr	Corel WordPerfect (6 onwards)	Y	Y	Y	N	P	Y	N	WordPerfect_6_Fmt
wpmsr	Corel WordPerfect Macintosh (1.02, 2, 2.1, 2.2, 3, 3.1)	Y	Y	Y	N	N	Y	N	WordPerfect_Mac_Fmt
xlsbsr	Microsoft Excel Binary Format (2007 onwards)	Y	Y	Y	N	Y	N	N	MS_Excel_Binary_2007_Fmt
xlssr	Microsoft Excel (2.2 to 2004)	Y	Y	Y	Y ²	Y	Y	Y ³	Excel_2000_Fmt , Excel_95_Fmt , Excel_97_Fmt , Excel_Chart_Fmt , Excel_Fmt , Excel_Macro_Fmt
xlsxsr	Microsoft Excel Windows XML (2007 onwards)	Y	Y	Y	Y	Y	Y	Y	MS_Excel_2007_Fmt , MS_Excel_Macro_2007_Fmt

¹Viewing and Export use the graphic reader, kpVSD2rdr for Microsoft Visio 2003, 2007, and 2010, and vsdsr for all earlier versions. Image fidelity in Viewing and Export is therefore only supported for versions 2003 and above. Filter uses the graphic reader kpVSD2rdr for Microsoft Visio 2003, 2007, and 2010, and vsdsr for all earlier versions.

²Supported using the embedded objects reader olesr.

³Microsoft Excel for Windows only

Reader	Description	Filter	Export	View	Extract	Metadata	Charset	H/F	Associated File Formats
xmldr	XML	Y	T	T	N	Y	Y	N	AMF_Fmt, AbiWord_Fmt, Adobe_XML_Data_Package_Fmt, Atom_Syndication_Fmt, CDXML_Fmt, Chemical_Markup_Language_Fmt, Collada_DAE_Fmt, Consolidated_CDA_Fmt, ESzigno_Fmt, FictionBook_Fmt, Grasshopper_GHX_Fmt, JNLP_Fmt, JavaView_JVX_Fmt, KML_Fmt, MAML_Fmt, MARC_XML_Fmt, METS_Fmt, MODS_Fmt, MS_Excel_XML_Fmt, MS_Management_Pack_MPX_Fmt, MS_Visio_XML_Fmt, MS_Word_XML_Fmt, MXML_Fmt, Mathcad_XML_Fmt, Metalink_Fmt, Mozilla_XUL_Fmt, MusicXML_Fmt, Open_Diagnostic_Data_Exchange_Fmt, Open_eBook_Fmt, PDF_XML_Forms_Data_Fmt, PGML_Fmt, PLS_Fmt, RDF_XML_Fmt, RSS_Fmt, Really_Simple_Discovery_Fmt, SBML_Fmt, SMIL_Fmt, SPARQL_Results_Fmt, SRGS_Fmt, SRU_Fmt, SSML_Fmt, SVG_Fmt, SyncML_Fmt, TEI_Fmt, Tableau_Data_Source_Fmt, Tableau_Map_Source_Fmt, Tableau_Preferences_Fmt, Tableau_Workbook_Fmt, Uniform_Office_Fmt, Uniform_Office_Text_Fmt, VTK_XML_Fmt, VoiceXML_Fmt, WML_Fmt, Windows_Audio_Playlist_Fmt, XAML_Browser_Application_Fmt, XBRL_Fmt, XDF_Fmt, XLIFF_Fmt, XML_Fmt, XML_Shareable_Playlist_Fmt, XSLT_Fmt, XSL_FO_Fmt, YIN_Fmt

Reader	Description	Filter	Export	View	Extract	Metadata	Charset	H/F	Associated File Formats
xpssr	Microsoft XML Paper Specification	Y	T	T	N	N	N	N	MS_XPS_Fmt
xywsr	XyWrite / Nota Bene (4.12)	Y	Y	Y	N	N	N	N	XyWrite_Fmt
yimsr ¹	Yahoo! Instant Messenger	Y	Y	Y	N	N	N	N	YIM_Fmt
z7zsr	7-Zip archive (4.57)	N	N	Y	Y	N	n/a	N	Z7Z_Fmt

¹To successfully use this reader, you must set the KV_YAHOO_ID environment variable to the Yahoo user ID. You can optionally set the KV_OTHER_YAHOO_ID environment variable to the other Yahoo user ID. If you do not set it, "Other" is used by default. If you enter incorrect values for the environment variables, erroneous data is generated.

Appendix C: Character Sets

This section provides information on the handling of character sets in the KeyView suite of products, which includes KeyView Filter SDK, KeyView Export SDK, and KeyView Viewing SDK.

- [Multibyte and Bidirectional Support](#)424
- [Coded Character Sets](#)432

Multibyte and Bidirectional Support

The KeyView SDKs can process files that contain multibyte characters. A multibyte character encoding represents a single character with consecutive bytes. KeyView can also process text from files that contain bidirectional text. Bidirectional text contains both Latin-based text which is read from left to right, and text that is read from right to left (Hebrew and Arabic).

The following table indicates which character encodings are supported by KeyView for each format.

Multibyte and bidirectional support

Format	Single-byte	Multibyte	Bidirectional
Archive			
7-Zip (7Z)	n/a	n/a	n/a
AD1 Evidence file	n/a	n/a	n/a
ADJ	n/a	n/a	n/a
B1	n/a	n/a	n/a
BinHex (HGX)	n/a	n/a	n/a
Bzip2 (BZ2)	n/a	n/a	n/a
EnCase – Expert Witness Compression Format (E01)	n/a	n/a	n/a
GZIP (GZ)	n/a	n/a	n/a
ISO (ISO)	n/a	n/a	n/a
Java Archive (JAR)	n/a	n/a	n/a
Legato EMailXtender Archive (EMX)	n/a	n/a	n/a
MacBinary (BIN)	n/a	n/a	n/a

Multibyte and bidirectional support, continued

Format	Single-byte	Multibyte	Bidirectional
Mac Disk Copy Disk Image (DMG)	n/a	n/a	n/a
Microsoft Backup File (BKF)	n/a	n/a	n/a
Microsoft Cabinet format (CAB)	n/a	n/a	n/a
Microsoft Compiled HTML Help (CHM)	n/a	n/a	n/a
Microsoft Compressed Folder (LZH)	n/a	n/a	n/a
PKZip (ZIP)	n/a	n/a	n/a
Microsoft Outlook DBX (DBX)	Y	Y	Y
Microsoft Outlook Offline Storage File (OST)	Y	Y	Y
RAR Archive (RAR)	n/a	n/a	n/a
Tape Archive (TAR)	n/a	n/a	n/a
UNIX Compress (Z)	n/a	n/a	n/a
UUEncoding (UUE)	n/a	n/a	n/a
Windows Scrap File (SHS)	n/a	n/a	n/a
WinZip (ZIP)	n/a	n/a	n/a
Binary			
Executable (EXE)	n/a	n/a	n/a
Link Library (DLL)	n/a	n/a	n/a
Computer-aided Design			
AutoCAD Drawing (DWG)	Y	Y	Y
AutoCAD Drawing Exchange (DXF)	Y	Y	Y
CATIA formats (CAT)	Y	N	N
Microsoft Visio (VSD)	Y	Y	Y
Database			
dBase Database	Y	N	N
Microsoft Access (MDB)	Y	Y	N
Microsoft Project (MPP)	Y	Y	N

Multibyte and bidirectional support, continued

Format	Single-byte	Multibyte	Bidirectional
Desktop Publishing			
Microsoft Publisher	N	Y	N
Display			
Adobe Portable Document Format (PDF) (basic reader)	Y	Y ¹	Y
Adobe Portable Document Format (PDF) (graphic-based reader)	Y	Y ¹	Y
Graphics			
Computer Graphics Metafile (CGM)	Y	N	N
Corel DRAW (CDR)	n/a	n/a	n/a
DCX Fax System (DCX)	Y	N	N
DICOM – Digital Imaging and Communications in Medicine (DCM)	n/a	n/a	n/a
Encapsulated PostScript (EPS)	Y	N	N
Enhanced Metafile (EMF)	Y	Y	N
Graphic Interchange Format (GIF)	n/a	n/a	n/a
JBIG2	n/a	n/a	n/a
JPEG	n/a	n/a	n/a
JPEG 2000	n/a	n/a	n/a
Lotus AMIDraw Graphics (SDW)	n/a	n/a	n/a
Lotus Pic (PIC)	n/a	n/a	n/a
Macintosh Raster (PICT/PCT)	n/a	n/a	n/a
MacPaint (PNTG)	n/a	n/a	n/a

¹ Multibyte PDFs are supported, provided the PDF document is created by using either Character ID-keyed (CID) fonts, predefined CJK CMap files, or ToUnicode font encodings, and does not contain embedded fonts. See the Adobe website and the Adobe Acrobat documentation for more information. Any multibyte characters that are not supported are displayed using the replacement character. By default, the replacement character is a question mark (?).

To determine the type of font encodings that are used in a PDF, open the PDF in Adobe Acrobat, and select File > Document Info > Fonts. If the Encoding column lists Custom or Embedded encodings, you might encounter problems converting the PDF.

Multibyte and bidirectional support, continued

Format	Single-byte	Multibyte	Bidirectional
Microsoft Office Drawing (MSO)	n/a	n/a	n/a
Omni Graffle (GRAFFLE)	Y	N	N
PC PaintBrush (PCX)	n/a	n/a	n/a
Portable Network Graphics (PNG)	n/a	n/a	n/a
SGI RGB Image (RGB)	n/a	n/a	n/a
Sun Raster Image (RS)	n/a	n/a	n/a
Tagged Image File (TIFF)	Y	N	N
Truevision Targa (TGA)	n/a	n/a	n/a
Windows Animated Cursor (ANI)	n/a	n/a	n/a
Windows Bitmap (BMP)	n/a	n/a	n/a
Windows Icon Cursor (ICO)	n/a	n/a	n/a
Windows Metafile (WMF)	Y	Y	N
WordPerfect Graphics 1 (WPG)	Y	N	N
WordPerfect Graphics 2 (WPG)	Y	N	N
Mail			
Documentum EMC MF Format	Y	Y	Y
Domino XML Language (DXL)	Y	Y	N
GroupWise FileSurf	Y	N	N
Legato Extender (ONM)	Y	Y	N
Lotus Notes database (NSF)	Y	Y	Y
Mailbox (MBX)	Y	Y	Y
Microsoft Entourage Database	Y	Y	Y
Microsoft Outlook (MSG)	Y	Y	Y
Microsoft Outlook Express (EML)	Y	Y	Y
Microsoft Outlook iCalendar	Y	Y	Y
Microsoft Outlook for Macintosh	Y	Y	Y
Microsoft Outlook Offline Storage File	Y	Y	Y
Microsoft Outlook Personal File	Y	Y	Y

Multibyte and bidirectional support, continued

Format	Single-byte	Multibyte	Bidirectional
Folders (PST)			
Microsoft Outlook vCard Contact			
Text Mail (MIME)	Y	Y	Y
Transport Neutral Encapsulation Format	Y	Y	Y
Multimedia			
Advanced Systems Format (ASF)	n/a	n/a	n/a
Audio Interchange File Format (AIFF)	n/a	n/a	n/a
Microsoft Wave Sound (WAV)	n/a	n/a	n/a
MIDI (MID)	n/a	n/a	n/a
MPEG 1 Audio Layer 3 (MP3)	n/a	n/a	n/a
MPEG 1 Video (MPG)	n/a	n/a	n/a
MPEG 2 Audio (MPEGA)	n/a	n/a	n/a
MPEG 4 Audio (MP4)	n/a	n/a	n/a
NeXT/Sun Audio (AU)	n/a	n/a	n/a
QuickTime Movie (QT/MOV)	n/a	n/a	n/a
Windows Video (AVI)	n/a	n/a	n/a
Presentations			
Apple iWork Keynote (GZ)	Y	Y	N
Applix Presents (AG)	character set 1252 only	N	N
Corel Presentations (SHW)	character set 1252 only	N	N
Extensible Forms Description Language (XFD)	Y	Y	N
Lotus Freelance Graphics 2 (PRE)	character set 850 only	N	N
Lotus Freelance Graphics (PRZ)	Y	Japanese, Simple Chinese, Traditional Chinese, Thai only	N
Macromedia Flash (SWF)	Y	Y	N

Multibyte and bidirectional support, continued

Format	Single-byte	Multibyte	Bidirectional
Microsoft OneNote	Y	Y	N
Microsoft PowerPoint PC (PPT)	character set 1252 only	Traditional Chinese only	N
Microsoft PowerPoint Windows (PPT)	Y	Japanese, Simple Chinese, Traditional Chinese, Korean only	Hebrew only
Microsoft PowerPoint Macintosh (PPT)	Y	N	N
Microsoft PowerPoint Windows XML 2007 and 2010 (PPTX)	Y	Y	Y
OASIS Open Document (ODP)	Y	Y	N
OpenOffice Impress (ODP)	Y	Y	N
StarOffice Impress (ODP)	Y	Y	N
Spreadsheets			
Apple iWork Numbers (GZ)	Y	Y	N
Applix Spreadsheets (AS)	character set 1252 only	N	N
Comma Separated Values (CSV)	character set 1252 only	N	N
Corel Quattro Pro (QPW/WB3)	Y	N	N
Data Interchange Format (DIF)	Y	Y	Y ¹
Lotus 1-2-3 (123)	Y	Y	Y
Lotus 1-2-3 (WK4)	Y	Y	N
Lotus 123 Charts (123)	Y	Y	N
Microsoft Excel Charts (XLS)	Y	Y	N
Microsoft Excel Macintosh (XLS)	Y	N	N
Microsoft Excel Windows (XLS)	Y	Y	Y ²
Microsoft Excel Windows XML 2007 (XLSX)	Y	Y	N
Microsoft Office Excel Binary Format (XLSB)	Y	Y	N
Microsoft Works Spreadsheet	Y	N	N

Multibyte and bidirectional support, continued

Format	Single-byte	Multibyte	Bidirectional
(S30/S40)			
OASIS Open Document (ODS)	Y	Y	N
OpenOffice Calc (ODS)	Y	Y	N
StarOffice Calc (ODS)	Y	Y	N
Text and Markup			
ANSI (TXT)	Y	Y	Y ²
ASCII (TXT)	Y	Y	Y ²
HTML (HTM)	Y	Y	Y ² , ²
Microsoft Excel Windows XML 2003	Y	Y	Y
Microsoft Word for Windows XML 2003	Y	Y	Y
Microsoft Visio XML 2003	Y	Y	Y
Rich Text Format (RTF)	Y	Y	Y ³
Unicode HTML	Y	Y	Y ^{2,3}
Unicode Text (TXT)	Y	Y	Y ²
XHTML	Y	Y	Y ³
XML	Y	Y	Y
Word Processing			
Adobe Maker Interchange Format (MIF)	character set 1252 only	N	N
Apple iChat Log (ICHAT)	Y	Y	N
Apple iWork Pages (GZ)	Y	Y	N
Applix Words (AW)	character set 1252 only	N	N
DisplayWrite (IP)	character set 500, 1026 only	N	N
Folio Flat File (FFF)	character set 1252 only	N	N
Founder Chinese E-paper Basic (CEB)	Y	Y	N

Multibyte and bidirectional support, continued

Format	Single-byte	Multibyte	Bidirectional
Fujitsu Oasys (OA2)	Y	Y	N
Hangul (HWP)	Y	Y	N
Health level7 (HL7)	Y	Y	Y
IBM DCA/RTF (DC)	character sets 500, 1026 only	N	N
JustSystems Ichitaro (JTD)	Y	Y	N
Lotus AMI Pro (SAM)	Y	Simple Chinese, Traditional Chinese, Japanese, Thai only	Y
Lotus AMI Professional Write Plus (AMI)	Y	Simple Chinese, Traditional Chinese, Japanese, Thai only	N
Lotus Word Pro (LWP)	Y	Y	Y ³
Lotus SmartMaster (MWP)	Y	Y	N
Microsoft Word PC (DOC)	character set 1252 only	N	N
Microsoft Word Windows V1-2 (DOC)	Y	N	N
Microsoft Word Windows V6, 7, 8, 95 (DOC)	Y	Y	Hebrew only ³
Microsoft Word Windows V97 through 2003 (DOC)	Y	Y	Y ³
Microsoft Word Windows XML 2007 and 2010 (DOCX)	Y	Y	Y ³
Microsoft Word Macintosh (DOC)	Y	N	Y ³
Microsoft Works (WPS)	Y	Japanese only	N
Microsoft Write (WRI)	Y	Japanese only	N
OASIS Open Document (ODT)	Y	Y	N
Omni Outliner (OO3)	Y	Y	N
OpenOffice Writer (ODT)	Y	Y	N
Open Publication Structure eBook (EPUB)	Y	Y	Y
StarOffice Writer (ODT)	Y	Y	N

Multibyte and bidirectional support, continued

Format	Single-byte	Multibyte	Bidirectional
Skype Log (DBB)	Y	Y (null-terminated charsets)	N
WordPad (RTF)	Y	Y	Y
WordPerfect Linux (WPS)	Y	N	N
WordPerfect Macintosh (WPS)	Y	N	N
WordPerfect Windows (WO)	Y	N	N
XML Paper Specification (XPS)	Y	Y	N
XYWrite Windows (XY4)	character set 1252 only	N	N
Yahoo! Instant Messenger (DAT)	Y	Y (null-terminated charsets)	N

¹The text direction in the output file might not be correct.

²In Export SDK, a bidirectional right-to-left (RTL) tag is extracted from this format and included in the direction element (<dir=RTL>) of the output.

Coded Character Sets

This section lists which character set you can use to specify the target character set. The coded character sets are enumerated in `kvcharset.h` and defined in the Export class.

Code Character Sets

Coded Character Set	Description	Can be set as target charset?
KVCS_UNKNOWN	Unknown character set	N
KVCS_SJIS	Japanese (uses multibyte encoding), cp932	Y
KVCS_GB	Simplified Chinese (China, Singapore, Malaysia) cp936	Y
KVCS_BIG5	Traditional Chinese (Taiwan, Hong Kong, Macaw) cp950	Y
KVCS_KSC	Korean, cp949	Y
KVCS_1250	Windows Latin 2 (Central Europe)	Y

Code Character Sets, continued

Coded Character Set	Description	Can be set as target charset?
KVCS_1251	Windows Cyrillic (Slavic)	Y
KVCS_1252	Windows Latin 1 (ANSI)	Y
KVCS_1253	Windows Greek	Y
KVCS_1254	Windows Latin 5 (Turkish)	Y
KVCS_1255	Windows Hebrew	Y
KVCS_1256	Windows Arabic	Y
KVCS_1257	Windows Baltic Rim	Y
KVCS_1258	Windows Vietnamese	Y
KVCS_8859_1	ISO 8859-1 Latin 1 (Western Europe, Latin America)	Y
KVCS_8859_2	ISO 8859-2 Latin 2 (Central Eastern Europe)	Y
KVCS_8859_3	ISO 8859-3 Latin 3 (S.E. Europe)	Y
KVCS_8859_4	ISO 8859-4 Latin 4 (Scandinavia/Baltic)	Y
KVCS_8859_5	ISO 8859-5 Latin/Cyrillic	Y
KVCS_8859_6	ISO 8859-6 Latin/Arabic	Y
KVCS_8859_7	ISO 8859-7 Latin/Greek	Y
KVCS_8859_8	ISO 8859-8 Latin/Hebrew	Y
KVCS_8859_9	ISO 8859-9 Latin/Turkish	Y
KVCS_8859_14	ISO 8859-14	Y
KVCS_8859_15	ISO 8859-15	Y
KVCS_437	DOS Latin US	Y
KVCS_737	DOS Greek	Y
KVCS_775	DOS Baltic Rim	Y
KVCS_850	DOS Latin 1	Y
KVCS_851	DOS Greek	Y
KVCS_852	DOS Latin 2	Y

Code Character Sets, continued

Coded Character Set	Description	Can be set as target charset?
KVCS_855	DOS Cyrillic	Y
KVCS_857	DOS Turkish	Y
KVCS_860	DOS Portuguese	Y
KVCS_861	DOS Icelandic	Y
KVCS_862	DOS Hebrew	Y
KVCS_863	DOS Canadian French	Y
KVCS_864	DOS Arabic	Y
KVCS_865	DOS Nordic	Y
KVCS_866	DOS Cyrillic Russian	Y
KVCS_869	DOS Greek 2	Y
KVCS_874	Thai	Y
KVCS_PDFMACDOC	PDF MAC DOC	N
KVCS_PDFWINDOC	PDF WIN DOC	N
KVCS_STDENC	Adobe Standard Encoding	N
KVCS_PDFDOC	Adobe standard PDF character set	N
KVCS_037	EBCDIC code page 037	Y
KVCS_1026	EBCDIC code page 1026	Y
KVCS_500	EBCDIC code page 500	Y
KVCS_875	EBCDIC code page 875	Y
KVCS_LMBCS	Lotus multibyte character set Group 1 and Group 2	N
KVCS_UNICODE	Unicode, UCS-2	N
KVCS_UTF16	16-bit Unicode transformation format	N
KVCS_UTF8	8-bit Unicode transformation format	Y
KVCS_UTF7	7-bit Unicode transformation format	Y
KVCS_2022_JP	ISO 2022-JP, Japanese mail and news safe	N

Code Character Sets, continued

Coded Character Set	Description	Can be set as target charset?
	encoding (JIS-7)	
KVCS_2022_CN	ISO 2022-CN, Chinese mail and news safe encoding	N
KVCS_2022_KR	ISO 2022-KR, Korean mail and news safe encoding	N
KVCS_WP6X	Word Perfect 6.x and higher character mapping	N
KVCS_10000	Western European (Macintosh)	Y
KVCS_KSC5601	Unified Hangul	Y
KVCS_GB2312	Simplified Chinese (China, Singapore, Hong Kong)	Y
KVCS_GB12345	Traditional Chinese (China) - analogue of GB2312	Y
KVCS_CNS11643	Traditional Chinese - Taiwan. Supplement to Big5	Y
KVCS_JIS0201	Japanese - contains ASCII character set (JIS-Roman)	N
KVCS_JIS0212	Japanese. Supplement to JIS0208.	Y
KVCS_EUC_JP	Japanese Extended UNIX Code	Y
KVCS_EUC_GB	Simplified Chinese Extended UNIX Code	Y
KVCS_EUC_BIG5	Traditional Chinese Extended UNIX Code	N
KVCS_EUC_KSC	Korean Extended UNIX Code	N
KVCS_424	EBCDIC Hebrew	N
KVCS_856	PC Hebrew (old)	N
KVCS_1006	IBM AIX Pakistan (Urdu)	N
KVCS_KOI8R	Cyrillic (Russian)	Y
KVCS_PDF_JAPAN1	Adobe-Japan1-2 character collection	N
KVCS_PDF_KOREA1	Adobe-Korea1-0 character collection	N
KVCS_PDF_GB1	Adobe-GB1-3 character collection	N

Code Character Sets, continued

Coded Character Set	Description	Can be set as target charset?
KVCS_PDF_CNS1	Adobe-CNS1-2 character collection	N
KVCS_2022_JP_8	ISO 2022-JP, Japanese mail and news safe encoding (JIS8)	N
KVCS_720	Arabic DOS-720	Y
KVCS_VISCII	Vietnamese VISCII	Y
KVCS_8859_10	ISO 8859-10 (Latin 6 Nordic)	Y ¹
KVCS_8859_13	ISO 8859-13 (Latin 7 Baltic)	Y ¹
KVCS_57002	ISCII Devanagari (x-iscii-de)	Y ¹
KVCS_57003	ISCII Bengali (x-iscii-be)	Y ¹
KVCS_57004	ISCII Tamil (x-iscii-ta)	Y ¹
KVCS_57005	ISCII Telugu (x-iscii-te)	Y ¹
KVCS_57006	ISCII Assamese (x-iscii-as)	Y ¹
KVCS_57007	ISCII Oriya (x-iscii-or)	Y ¹
KVCS_57008	ISCII Kannada (x-iscii-ka)	Y ¹
KVCS_57009	ISCII Malayalam (x-iscii-ma)	Y ¹
KVCS_57010	ISCII Gujarathi (x-iscii-gu)	Y ¹
KVCS_57011	ISCII Panjabi (x-iscii-pa)	Y ¹
KVCS_GB18030b2	Reserved for internal use	n/a
KVCS_GB18030	GB18030 (Chinese 4-byte character set)	Y
KVCS_8859_11	ISO 8859-11 (Thai)	Y
KVCS_8859_16	ISO 8859-16 (Latin-10 South-Eastern Europe)	Y
KVCS_ARABICMAC	Arabic Mac (x-mac-arabic)	Y
KVCS_KOI8U	Cyrillic (KOI8U Ukrainian)	Y
KVCS_HZGB2312	The 7-bit representation of GB 2312 / RFC 1842	n/a

Code Character Sets, continued

Coded Character Set	Description	Can be set as target charset?
KVCS_UTF32	32-bit Unicode transformation format	N

¹The character set cannot be forced as output in Export SDK and Viewing SDK because the character set is not supported by the major browsers.

Appendix D: Extract and Format Lotus Notes Subfiles

This section describes how to create XML templates to alter the appearance of extracted Lotus mail note subfiles so that they maintain the look and feel of the original notes.

- [Overview](#) 438
- [Customize XML Templates](#) 438
- [Template Elements and Attributes](#) 440
- [Date and Time Formats](#) 445

Overview

KeyView uses the NSF reader, `nsfsr`, to extract Lotus database files, and places Lotus mail notes in subfiles. The NSF reader uses a set of default XML templates to extract the notes and apply formatting, thereby approximating the look and feel of the original notes.

In some cases, you might need to customize the XML templates, for instance if your notes contain custom data. In such cases, you can modify the existing XML templates or create your own.

During extraction, the NSF reader loads all XML files in the `NSFtemplates` directory and its subdirectories (except for the `NSFtemplates\images` directory, which is reserved for images). During initialization, the KeyView XML parser verifies the XML templates. If the templates contain any invalid XML, elements, or attributes, initialization fails and errors are recorded in the `nsfsr.log` file.

Customize XML Templates

XML templates are enabled by default. In most cases, the default templates should be sufficient; however, you can customize them or create your own as required.

To customize XML templates for Lotus note extraction

1. Modify the template files in the following directory.

```
install\OS\bin\NSFtemplates
```

The `main.xml` file must exist in the `NSFtemplates` directory. It is the top-level template file that extracts all subfiles, usually by calling other templates.

2. Make sure that any modifications or additional XML files conform to the supported elements and attributes described in [Template Elements and Attributes](#), on page 440.
3. Extract the Lotus database file.

Use Demo Templates

For testing purposes, you can extract notes by using a set of demo templates, which are provided to demonstrate the proper usage of all the XML elements and attributes, because the default templates do not use all the XML elements.

The demo templates are available at:

```
install\OS\bin\NSFtemplates
```

To use the demo XML templates

1. In the `formats.ini` file, set the following parameter.

```
[nsfsr]  
UseDemoTemplate=1
```

2. In the `main.xml` file, uncomment the following section.

```
<ifini name="UseDemoTemplate" text="1">  
  <call file="demo.xml"/>  
  <quit/>  
</ifini>
```

Use Old Templates

For testing purposes, you can extract notes by using legacy templates, which produce MHTML output. You can generate similar output by disabling the XML templates, but using the old templates enables you to see the XML code and compare it to the standard and demo templates.

To use the old XML templates

1. In the `formats.ini` file, set the following parameter.

```
[nsfsr]  
UseOldTemplate=1
```

2. In the `main.xml` file, uncomment the following section.

```
<ifini name="UseOldTemplate" text="1">  
  <call file="default_old.xml">  
  <quit>  
</ifini>
```

Disable XML Templates

For testing purposes, you can disable XML templates; KeyView extracts the notes in MHTML format. You can compare the MHTML output directly by the NSF reader with the MHTML output indirectly by the NSF reader through the XML templates.

To disable XML templates

1. In the `formats.ini` file, set the following parameter.

```
[nsfsr]
ExtractByTemplate=0
```

Template Elements and Attributes

This section lists the valid XML elements and attributes that you can use when creating or modifying templates. See the demo templates for examples.

Conditional Elements

The following table lists the valid conditional elements.

Conditional elements

Element	Description
<keyview>	The KeyView XML template container ("root") element
<if*>	<p>If the condition from the comparison is true, process the XML. Conditions can be nested up to 25 levels deep.</p> <p>Attributes</p> <ul style="list-style-type: none"> • <code>name</code>. (Required) The name of the main item to compare to <code>item</code> or <code>text</code>. • <code>item</code>. (Required if no <code>text</code>) The name of the item to compare to the item specified by <code>name</code>. • <code>text</code>. (Required if no <code>item</code>) The text to compare to the item specified by <code>name</code>.
<ifex>, <ifnx>	<p>If <code>name</code> item exists and has a <code>text</code> value or not.</p> <p>The Notes item might have a value that cannot be converted to text, such as an image.</p>
<ifeq>, <ifne>, <iflt>, <ifle>, <ifgt>, <ifge>	<p>Respectively, if <code>text</code> ==, !=, <, >, <=, >, >=.</p> <p>Text comparison uses a case-insensitive string compare.</p>
<iftdq>, <iftdne>, <iftdlt>, <iftdle>, <iftdgt>, <iftdge>	<p>Respectively, if <code>time/date</code> ==, !=, <, >, <=, >, >=.</p> <p>Time/date comparison converts dates to text in local time using the Notes default, <code>TZ_FMT_NEVER</code>, because Notes also sometimes converts fields to text internally. For example:</p>

Conditional elements, continued

Element	Description
	text="06/30/2005 02:52:04 PM"
<iftzeq>, <iftzne>	Respectively, if the time zone equals or does not equal the comparison text, for example CDT, EST, and so on.
<ifini>	If the value of the INI option specified in name equals the text value.
<else>	If the condition from the last <if> or <switch> was false, process XML.
<switch>	If a name value exists, process XML. Attributes <ul style="list-style-type: none"> name. (Required) The name of the main item to compare in <case> subelements.
<case>	If the comparison condition is true, process XML, then stop processing the rest of <switch>. Attributes <ul style="list-style-type: none"> text. (Required) The text to compare to the name item of <switch>.
<default>	If all <case> conditions were false, process XML. This element must be the last element in <switch>, after all the <case> elements. Any <case> elements after the <default> element are ignored.
<for>	If a name value exists, process XML. Process for each part of the name item. Attributes <ul style="list-style-type: none"> name. (Required) The name of the main item. max. (Optional) The maximum index to process. By default, all are processed.
<index>	Output <for> loop index (1-based). <index> is only valid within a <for> element.

Control Elements

The following table lists the valid control elements.

Control Elements

Element	Description
<call>	<p>Call another XML template. You can nest templates up to 10 levels deep.</p> <p>Attributes</p> <ul style="list-style-type: none"> file. (Required) The template file name. This name must be unique.
<log>	<p>Log message to the NSF log file.</p> <p>Attributes</p> <ul style="list-style-type: none"> text. (Required) The text to log. type. (Optional) The type of log message. The following values are valid: <ul style="list-style-type: none"> ERROR WARN INFO DIAG (the default option) DEBUG DUMP
<quit>	<p>Stop processing the template. Exits without error.</p> <p>Attributes</p> <ul style="list-style-type: none"> text. (Optional) The text to log. type. (Optional) The type of log message. See <log>, above.
<stop>	<p>Stop processing the template. Exits with an ERROR log message.</p> <p>Attributes</p> <ul style="list-style-type: none"> text. (Required) The text to log.

Data Elements

The following table lists the valid data elements.

Data elements

Element	Description
<text>	<p>Output text.</p> <p>Attributes</p> <ul style="list-style-type: none"> name. (Required if there is no parent) The name of the item to output.

Data elements, continued

Element	Description
<rich>	<p>Output rich text (MHTML). Images are output in the next part or parts of the MHTML, after the first <HTML> part.</p> <p>Attributes</p> <ul style="list-style-type: none"> name. (Required if there is no parent) The name of the item to output.
<body>	<p>Output the message body in rich text (MHTML). As with <rich>, above, images are output in the next part or parts of the MHTML.</p>
<form>	<p>Output the message form (usually \$Body field) in rich text (MHTML).</p> <p>Attributes</p> <ul style="list-style-type: none"> name. (Required if there is no parent) The name of the item to output.
<addr>	<p>Output an address.</p> <p>Attributes</p> <ul style="list-style-type: none"> name. (Required if there is no parent) The name of the item to output. type. (Optional) The type of address to output. Set this attribute to CN (Common Name), which is the only supported type.
<name>	<p>Output the name of the last name item, or in other words the current main item. The item must exist.</p>
<format>	<p>Set the default format for <date> and <date_kv>. This element does not set the <text> format. See Date and Time Formats, on page 445 for a list of all Notes and KeyView date and time formats and integer values.</p> <p>Attributes</p> <ul style="list-style-type: none"> format. (Optional. Omit to reset to defaults) The Notes and KeyView date and time format. You can set the following formats: <ul style="list-style-type: none"> TD=int. The Time Date format (TDFMT_*) TS=int. The Time Show format (TSFMT_*) TT=int. The Time Time format (TTFMT_*) TZ=int. The Time Zone format (TZFMT_*) KV=int. The KeyView date and time format <p>where int is an integer value that corresponds to the desired format.</p> <p>Separate multiple formats with commas. For example:</p> <pre>format="TD=0,TS=2,TT=1,TZ=1,KV=55"</pre>
<date>	<p>Output a Notes date.</p>

Data elements, continued

Element	Description
	<p>Attributes</p> <ul style="list-style-type: none"> • name. (Required if there is no parent) The name of the item to output. • format. (Optional) See <format>, on the previous page. You can set the following values: <ul style="list-style-type: none"> ◦ TD ◦ TS ◦ TT ◦ TZ
<date_kv>	<p>Output a KeyView date.</p> <p>Attributes</p> <ul style="list-style-type: none"> • name. (Required if there is no parent) The name of the item to output. • format. (Optional) See <format>, on the previous page. You can set the following values: <ul style="list-style-type: none"> ◦ TZ ◦ KV
<time>	<p>Output a time range, for example 1 hour, 30 minutes.</p> <p>Attributes</p> <ul style="list-style-type: none"> • name. (Required if there is no parent) The item name of the start date or time. • item. (Required) The item name of the end date or time.
<zone>	<p>Output a Notes time zone mnemonic, for example MST.</p> <p>Attributes</p> <ul style="list-style-type: none"> • name. (Required if there is no parent) The name of date item to output.
<zone_utc>	<p>Output a time zone as UTC, for example (UTC-06:00).</p>
<logo>	<p>Output the mail header logo.</p> <p>The image link is included in the output; the actual image is output to a different part of the MHTML subfile.</p>
<image>	<p>Output an image.</p> <p>The image link is included in the output; the actual image is output to the MHTML next part, as with <rich>, on the previous page and <body>, on the previous page.</p>
<image_>	<p>Output an image URI, in quotation marks. The actual image is output to a different part of</p>

Data elements, continued

Element	Description
uri>	the MHTML subfile. Attributes <ul style="list-style-type: none"> • link. (Required if there is no file) The image link, such as a form or title name. For example: <ul style="list-style-type: none"> • link="StdNotesLtr0" • file. (Required if there is no link) The name of the image file. The file must exist in the ../../templates/images directory. For example: <ul style="list-style-type: none"> • file="boxcheck.gif"

Date and Time Formats

This section lists the supported Notes and KeyView date and time formats for use with `<format>`, `<date>`, and `<date_kv>`.

Lotus Notes Date and Time Formats

This section lists supported Lotus Notes date and time formats, and the integer values that specify each one.

Lotus Notes date and time formats

Format	Integer Value	Description
TDFMT_FULL	0	(The Notes default) Year, month, and day
TDFMT_CPARTIAL	1	Month and day, year if not this year
TDFMT_PARTIAL	2	Month and day
TDFMT_DPARTIAL	3	Year and month
TDFMT_FULL4	4	Four-digit year, month, and day
TDFMT_CPARTIAL4	5	Month and day, four-digit year if not this year
TDFMT_DPARTIAL4	6	Four-digit year and month

Lotus Notes date and time formats, continued

Format	Integer Value	Description
TTFMT_FULL	0	(Notes default) Hour, minute, and second
TTFMT_PARTIAL	1	Hour and minute
TTFMT_HOUR	2	Hour
TZGMT_NEVER	0	(Notes default) All time zones are converted to the current time zone
TZGMT_SOMETIMES	1	Show only when outside the current time zone
TZGMT_ALWAYS	2	Show for all time zones
TSFMT_DATE	0	Date
TSFMT_TIME	1	Time
TSFMT_DATETIME	2	(The Notes default) Date and time
TSFMT_CDATETIME	4	Date and time, or time today or time yesterday

KeyView Date and Time Formats

This section lists KeyView date and time formats. The KeyView formats use the following syntax:

- Month
 - Month = full month name
 - Mon = abbreviated month name
 - m = month (number)
 - mm = two-digit month (leading 0)
- Weekday
 - Weekday = full weekday name
 - Wday = abbreviated weekday name
- Year
 - yy = two-digit year
 - yyyy = four-digit year
- >Day
 - d = day (number)
 - dd = two-digit day (leading 0)
- Time
 - h = 12-hour
 - H = 24-hour

m = minutes

s = seconds

P = AM/PM

p = am/pm

Separators _ = space

c = comma

s = slash

a = dash

o = dot

KeyView date and time formats

Format	Output	Integer Value
12-Hour and 24-Hour Time Formats		
KVDTF_P	P	1
KVDTF_P_hmm	P h:mm	2
KVDTF_hmm_P	h:mm P	3
KVDTF_P_hhmm	P hh:mm	4
KVDTF_hhmm_P	hh:mm P	5
KVDTF_P_hmmss	P h:mm:ss	6
KVDTF_hmmss_P	h:mm:ss P	7
KVDTF_P_hhmmss	P hh:mm:ss	8
KVDTF_hhmmss_P	hh:mm:ss P	9
KVDTF_Hmm	H:mm	10
KVDTF_HHmm	HH:mm	11
KVDTF_mmss	mm:ss	12
KVDTF_Hmmss	H:mm:ss	13
KVDTF_HHmss	HH:mm:ss	14
Numerical Date Formats with Slashes		
KVDTF_mmsdd	mm/dd	15
KVDTF_msdsyy	m/d/yy	16

KeyView date and time formats, continued

Format	Output	Integer Value
KVDTF_mmsddsyy	mm/dd/yy	17
KVDTF_mmsddsyyyy	mm/dd/yyyy	18
KVDTF_ddsmm	dd/mm	19
KVDTF_ddsmsyy	dd/mm/yy	20
KVDTF_ddsmsyy_Hmm	dd/mm/yy H:mm	21
KVDTF_ddsmm_P_hmm	dd/mm P h:mm	22
KVDTF_ddsmm_hmm_P	dd/mm h:mm P	23
KVDTF_ddsmm_P_hhmm	dd/mm P hh:mm	24
KVDTF_ddsmm_hhmm_P	dd/mm hh:mm P	25
KVDTF_ddsmsyy_P_hmm	dd/mm/yy P h:mm	26
KVDTF_ddsmsyy_hmm_P	dd/mm/yy h:mm P	27
KVDTF_ddsmsyy_P_hmmss	dd/mm/yy P h:mm:ss	28
KVDTF_ddsmsyy_hmmss_P	dd/mm/yy h:mm:ss P	29
KVDTF_ddsmsyy_P_hhmmss	dd/mm/yy P hh:mm:ss	30
KVDTF_ddsmsyy_hhmmss_P	dd/mm/yy hh:mm:ss P	31
KVDTF_yysmmsdd_P_hhmmss	yy/mm/dd P hh:mm:ss	32
KVDTF_yysmmsdd_hhmmss_P	yy/mm/dd hh:mm:ss P	33
KVDTF_msdsyy_Hmm	m/d/yy H:mm	34
KVDTF_mmsddsyy_Hmm	mm/dd/yy H:mm	35
KVDTF_msdsyy_P_hmm	m/d/yy P h:mm	36
KVDTF_msdsyy_hmm_P	m/d/yy h:mm P	37
KVDTF_mmsddsyy_hmm_P	mm/dd/yy h:mm P	38
KVDTF_mmsdd_P_hhmm	mm/dd P hh:mm	39
KVDTF_mmsdd_hhmm_P	mm/dd hh:mm P	40
KVDTF_mmsddsyy_P_hhmmss	mm/dd/yy P hh:mm:ss	41
KVDTF_mmsddsyy_hhmmss_P	mm/dd/yy hh:mm:ss P	42

KeyView date and time formats, continued

Format	Output	Integer Value
KVDTF_msd	m/d	43
KVDTF_yysm	yy/m	44
KVDTF_yysmm	yy/mm	45
KVDTF_yysmsd	yy/m/d	46
KVDTF_yysmmsdd	yy/mm/dd	47
KVDTF_yyyysmmsdd	yyyy/mm/dd	48
Numerical Date Formats with Dashes		
KVDTF_ddammayy	dd-mm-yy	49
KVDTF_mmadd	mm-dd	50
KVDTF_mmayy	mm-yy	51
KVDTF_yyammadd	yy-mm-dd	52
KVDTF_yyyymmadd	yyyy-mm-dd	53
KVDTF_yyyymmaddaHHmss	yyyy-mm-dd-HH:mm:ss	54
Numerical Date Formats with Dots		
KVDTF_yyomod	yy.m.d	55
KVDTF_yyommodd	yy.mm.dd	56
KVDTF_mod	m.d	57
KVDTF_mmodd	mm.dd	58
Numerical and String Date Formats with Dashes, Commas, and Spaces		
KVDTF_ddaMon	dd-Mon	59
KVDTF_daMonayy	d-Mon-yy	60
KVDTF_ddaMonayy	dd-Mon-yy	61
KVDTF_ddaMonayyyy	dd-Mon-yyyy	62
KVDTF_Mon	Mon	63
KVDTF_Monayy	Mon-yy	64
KVDTF_Monayyyy	Mon-yyyy	65

KeyView date and time formats, continued

Format	Output	Integer Value
KVDTF_Monaddayy	Mon-dd-yy	66
KVDTF_yyammadd_P_hhmmss	yy-mm-dd P hh:mm:ss	67
KVDTF_mmadd_P_hhmm	mm-dd P hh:mm	68
KVDTF_Mon_yy	Mon yy	69
KVDTF_Monc_yy	Mon, yy	70
KVDTF_Month	Month	71
KVDTF_Monthayy	Month-yy	72
KVDTF_Month_yy	Month yy	73
KVDTF_Monthc_yy	Month, yy	74
KVDTF_Monthayyyy	Month-yyyy	75
KVDTF_Month_yyyy	Month yyyy	76
KVDTF_Monthc_yyyy	Month, yyyy	77
KVDTF_Mon_dc_yyyy	Mon d, yyyy	78
KVDTF_d_Monc_yyyy	d Mon, yyyy	79
KVDTF_yyyy_Mon_d	yyyy Mon d	80
KVDTF_Month_dc_yyyy	Month d, yyyy	81
KVDTF_d_Monthc_yyyy	d Month, yyyy	82
KVDTF_yyyy_Month_d	yyyy Month d	83
Weekday Date Formats		
KVDTF_wday	wday	84
KVDTF_Weekday	Weekday	85
KVDTF_wdayc_Mon_dc_yyyy	wday, Mon d, yyyy	86
KVDTF_Weekdayc_Month_dc_yyyy	Weekday, Month d, yyyy	87
KVDTF_Weekdayc_d_Monthc_yyyy	Weekday, d Month, yyyy	88

Appendix E: Export Tokens

This section contains an alphabetized list of the Export tokens.

Tokens are special strings inserted into the `KVHTMLTemplateEx` structure, `HtmlTemplateInfo` class, and template files. They are placeholders for markup that appears in the HTML output. For example, the `$CHARSET` token marks the place in the HTML output where the name of the source document's character set is inserted. It would be used in the tag `<charset=$CHARSET>`.

Word documents are split into blocks by heading level. By default, each section of text between Heading Level 1 headings will be a single block.

See the template files for examples of how to use tokens.

Export Tokens

Token	Description
<code>\$ANCHOR</code>	Inserts an anchor for a heading level (h2-h6) for the current block.
<code>\$BASE</code>	Inserts the base URL for the HTML file. Use in the <code><base href=xx></code> tag.
<code>\$CHARSET</code>	Inserts the character set of the source document, if that information is ascertainable. Document Readers, on page 392 lists the file formats for which character set information can be determined.
<code>\$CONTENT</code>	Inserts the content of the metadata field specified by the <code>\$NAME</code> token. This token is used in conjunction with the <code>\$SUMMARY</code> , <code>\$USERSUMMARY</code> , and <code>\$NAME</code> tokens to insert source document metadata into the HTML output. An example of this token's use is: <pre>pszUserSummary=<meta name="\$NAME" content="\$CONTENT"></pre> Document Readers, on page 392 lists file formats that support metadata.
<code>\$ENDNOTE</code>	Inserts endnotes from the current block at this point in the output stream. Currently implemented for Microsoft Word documents only.
<code>\$ENDNOTEALL</code>	Inserts all endnotes at this point in the output stream. Currently implemented for Microsoft Word documents only.
<code>\$FOOTER</code>	Inserts the footer from the current block at this point in the output stream.
<code>\$FOOTNOTE</code>	Inserts footnotes from the current block at this point in the output stream. Currently implemented for Microsoft Word documents only.
<code>\$FOOTNOTEALL</code>	Inserts all footnotes at this point in the output stream. Currently implemented for Microsoft Word documents only.
<code>\$HEADER</code>	Inserts the header from the current block at this point in the output stream.

Export Tokens, continued

Token	Description
\$MAINURL	Inserts the URL to the file containing the start of the generated HTML, that is, the main output stream.
\$NAME	<p>Inserts the name of a metadata field. This token is used in conjunction with the \$SUMMARY, below, \$USERSUMMARY, on the next page, and \$CONTENT, on the previous page tokens to insert source document metadata into the HTML output. An example of this token's use is:</p> <pre>pszUserSummary=<meta name="\$NAME" content="\$CONTENT"></pre> <p>The section Document Readers, on page 392 lists file formats that support metadata.</p>
\$NEXT	Inserts the anchor to the next block. If this is the last block, a link to the first block is inserted.
\$PREV	Inserts the anchor to the previous block. If the current block is the first block, a link to the last block is inserted.
\$STYLESHEET	Inserts the path to the style sheet. Only available in KVHTMLOptionsEx.
\$SUMMARY	<p>Inserts the data from standard metadata fields using the markup provided in the pszUserSummary member of the structure KVHTMLTemplateEx. Standard fields are enumerated from 0 to 33 in KVSUMType in kvtypes.h. See the tokens \$USERSUMMARY, on the next page, \$NAME, above, and \$CONTENT, on the previous page.</p> <p>The section Document Readers, on page 392 lists file formats that support metadata.</p>
\$SUMMARY <i>NN</i>	<p>Inserts the data from a <i>specified</i> metadata field. <i>NN</i> is a number from 0 through 33 enumerated in the KVSUMType structure in kvtypes.h. An example of this token's use is:</p> <pre>pszMainTop=<head> <title> \$SUMMARY01 </title> </head> <body></pre> <p>The section Document Readers, on page 392 lists file formats that support metadata.</p>
\$SPLITBLOCKNUMBER	Inserts the page number for each block generated as a result of bHardPageMakesNewBlock or lcbBlockSize.
\$TOC	Inserts the table of contents at this point in the current output stream. This token is typically embedded in pszMainTop.
\$TOCB	Inserts the table of contents at this point for the current block.
\$TOCBE	Inserts the beginning entry for the table of contents at this point in the current output stream.

Export Tokens, continued

Token	Description
\$TOCE	Inserts a table of contents entry at this point in the current output stream.
\$TOCTE	Inserts a text entry without HTML markup at this point in the current output stream.
\$TOCPE	Inserts a partial table of contents entry at this point in the current output stream. HTML tags are removed; however, character entities are retained. This enables angle brackets to appear in the table of contents entries (for example, <text>). Without this token, <text> would be interpreted as a non-valid HTML tag and would be ignored by the browser.
\$TOPANCHOR	Inserts the anchor for the top heading level (h1) for the current block.
\$USERCB	Triggers the callback function UserCB() and identifies the callback used in the function.
\$USERSUMMARY	<p>Inserts the data from every valid non-standard metadata field using the markup provided in the pszUserSummary member of the KVHTMLTemplateEx structure. Non-standard metadata are any fields not listed from 0 to 33 in KVSUMType, such as user-defined fields (for example, custom property fields in Word documents), or fields that are unique to a particular file type (for example, "Artist" or "Genre" fields in MP3 files). See the tokens \$SUMMARY, on the previous page, \$NAME, on the previous page, and \$CONTENT, on page 451.</p> <p>The section Document Readers, on page 392 lists file formats that support metadata.</p>
\$XANCHOR	<p>Inserts the anchor to an extra file into the HTML output. An example of this token's use is:</p> <pre data-bbox="493 1318 1192 1381"><frame src="\$XANCHOR" name="Left" scrolling="auto" target="right"></pre> <p>The contents of the extra file is defined by pszXFile, and the block generated by this token is defined by pszXStartBlock and pszXEndBlock.</p>

Appendix F: File Format Detection

This section describes how file formats are detected in the KeyView Export SDK.

- [Introduction](#) 454
- [Extract Format Information](#) 454
- [Determine Format Support](#) 454
- [Translate Format Information](#) 457
- [Determine a Document Reader](#) 458
- [Category Values in formats_e.ini](#) 458

Introduction

The KeyView format detection module (`kwad`) detects a file's format, and reports the information to the API, which in turn reports the information to the developer's application. If the detected format is supported by the KeyView SDK, the detection module also loads the appropriate structured access layer and document reader for further processing.

For a list of supported formats, see [Document Readers, on page 392](#).

Extract Format Information

You can extract format information from a document by using the `fpGetStreamInfo()` function. If required, this format information can then be reported to the developer's application. The `fpGetStreamInfo()` function extracts format information, such as file class, format, and version, and populates the `ADDOCINFO` structure. This structure is defined in the `adinfo.h` header file.

For information on how to translate the extracted format information, see [Translate Format Information, on page 457](#).

Determine Format Support

After the file format is extracted, the detection module uses the `formats_e.ini` file to determine whether the format is supported by KeyView, and the appropriate structured access layer and reader to load.

The `formats_e.ini` file is in the directory `install\OS\bin`, where `install` is the path name of the Export installation directory and `OS` is the name of the operating system. It contains the following information:

- Coded format information. To translate this information, see [Translate Format Information, on page 457](#).
- The reader associated with each format. See [Determine a Document Reader, on page 458](#).
- Configuration parameters for out-of-process conversions.
- Locale settings for internal use.

Below are some entries from the `formats_e.ini` file:

```
123=mw
152=xyw
178=wp6
189=mw6
2=af
200=pdf
205=mb
210=htm
251=htm
```

NOTE: The `formats_e.ini` file applies to all formats except graphics. Detection of graphics formats is handled by an internal module named KeyView Picture Interchange Format (KPIF).

Refine Detection of Text Files

During text detection, KeyView analyzes the first 1 kB and last 1 kB of data in a document; if less than 10% of that data consists of non-ASCII characters, KeyView detects the document as a text file.

However, depending on the type of documents you are working with, the default settings might not provide the desired level of accuracy. Configuration flags allow you to change the amount of data to read at the end of a file, the percentage of non-ASCII characters permitted in a text file, and whether to use or ignore the file extension to determine the document format.

Change the Amount of File Data to Read

During file detection, KeyView reads characters from the beginning and end of a file—by default, it reads the first and last 1,024 bytes of data. Large text files might contain many irrelevant characters at the end of a file, so KeyView might not accurately detect the file format. You can set a configuration flag to increase the amount of data to read from the end of a file during detection.

To change the amount of data to read during detection

- In the `formats_e.ini` file, set the following flag in the `detection_flags` section:

```
[detection_flags]
non_ascii_chars_end_block_size=kB
```

where *kB* is the number of kilobytes to read from the end of the file, from 0 to 10. The default value is 1.

NOTE: The file size must be greater than the value specified in the flag. If the flag value is greater than the file size, KeyView does not use the flag.

Change the Percentage of Allowed Non-ASCII Characters

By default, if less than 10% of the analyzed data in a document consists of non-ASCII characters, it is detected as a text file. Depending on the type of files you are working with, changing the default percentage might increase detection accuracy.

To change the percentage of non-ASCII characters allowed in text files

- In the `formats_e.ini` file, set the following flag in the `detection_flags` section:

```
[detection_flags]
non_ascii_chars_in_text=N
```

where *N* is the percentage of non-ASCII characters to allow in text files. Files that contain a lower percentage of non-ASCII characters than *N* are detected as text files. The default value is 10.

Use the File Extension for Detection

Sometimes KeyView detects certain file formats (such as CSV) as ASCII because of the content of the documents. In such cases, you can configure KeyView to use the file extension to determine the document format. Using the file extension can improve detection of formats such as CSV, but might not detect text files successfully if they have incorrect file extensions.

To use the file extension for ASCII files during detection

- In the `formats.ini` file, set the following flag in the `detection_flags` section:

```
[detection_flags]
use_extension_for_ascii=1
```

The default is 0 (do not use the file extension).

Allow Consecutive NULL Bytes in a Text File

By default, if a document contains consecutive NULL bytes, it is not detected as text. Depending on the type of files you are working with, changing the default might increase detection accuracy.

To allow consecutive NULL bytes of ASCII characters in text files

In the `formats.ini` file, set the following flag in the `detection_flags` section:

```
[detection_flags]
ascii_allow_null_bytes=1
```

The default value is 0 (do not allow consecutive NULL bytes).

Translate Format Information

Format information can include file attributes in the following categories:

- Major format
- File class
- Minor format
- Major version
- Minor version

Not all categories are required. Many formats only include major format and file class, or major format only.

The format information has the following structure:

MajorFormat.FileClass.MinorFormat.MajorVersion.MinorVersion

For example:

81.2.0.9.0

Each number in the format information represents a file attribute. The entry 81.2.0.9.0 represents a Lotus 1-2-3 Spreadsheet file version 9.0, where:

81 = Lotus 1-2-3 Spreadsheet (major format)

2 = Spreadsheet (file class)

0 = not defined (minor format)

9 = 9 (major version)

0 = 0 (minor version)

The example above applies to `formats_e.ini` file. When extracting format information by using the `fpGetStreamInfo()` function method, the same format information is represented as 294.2.0.9.

NOTE: The format values returned by `fpGetStreamInfo()` differ from those in `formats_e.ini` because the former defines a unique ID for each major format, whereas the latter uses a major version, minor version, and minor format to distinguish between formats.

Distinguish Between Formats

The `ADDDOCINFO` structure method provides a unique ID for each major format. For example, a call to `fpGetStreamInfo()` returns 351.1.0 for a Microsoft Word 2003 XML format. The major format 351 is unique to this format.

Unlike `ADDDOCINFO`, the `formats_e.ini` file distinguishes between formats by using the major version number. For example, in `formats_e.ini`, a Microsoft Word 2003 XML format is defined as

285.1.0.100.0. The major format 285 and file class 1 are the same values for generic XML. The major version 100 distinguishes the format as Microsoft Word 2003 XML.

The major version is used in `formats_e.ini` to specify the following formats:

- The Microsoft Office 2003 XML format has the same major format and file class as generic XML (285.1). It is distinguished from generic XML by using the following major versions:
 - Word: 100
 - Excel: 101
 - Visio: 110
- The XHTML format has the same major format and file class as HTML (210.1). It is distinguished from HTML by using the major version 100.

Determine a Document Reader

The format detection module uses the `formats_e.ini` file to determine whether a format is supported and which reader should be used to parse a format. The entries in the `formats_e.ini` file lists each format's coded value, and an abbreviation for the format's reader. For example:

```
81.2.0.9.0=1123
```

The reader abbreviation is a truncated version of the reader's library name. Adding "sr" to the end of an abbreviation creates the name of the reader. The example entry above specifies that a Lotus 1-2-3 Spreadsheet file version 9.0 is parsed by the Lotus 1-2-3 reader, 1123sr.

[Files Required for Redistribution, on page 462](#) lists the document readers provided with KeyView.

Category Values in `formats_e.ini`

The [Supported Formats](#) section lists all of the file formats that can be detected by KeyView, with associated category values for use in the `formats_e.ini` file. The following tables provide the list of possible file classes and minor formats.

- [File Classes](#)
- [Minor Formats](#)

File Classes

Attribute Number	Description	File class
0	No file class	AutoDetNoFormat
01	Word processor	adWORDPROCESSOR

File Classes, continued

Attribute Number	Description	File class
02	Spreadsheet	adSPREADSHEET
03	Database	adDATABASE
04	Raster image	adRASTERIMAGE
05	Vector graphic	adVECTORGRAPHIC
06	Presentation	adPRESENTATION
07	Executable	adEXECUTABLE
08	Encapsulation	adENCAPSULATION
09	Sound	adSOUND
10	Desktop publishing	adDESKTOPPUBLSH
11	Outline/planning	adOUTLINE
12	Miscellaneous	adMISC
13	Mixed format	adMIXED
14	Font	adFONT
15	Time scheduling	adSCHEDULE
16	Communications	adCOMMUNICATION
17	Object module	adOBJECTMODULE
18	Library module	adLIBRARY
19	Fax	adFAXFORMAT
20	Movie	adMOVIE
21	Animation	adANIMATION
22	Source Code	adSOURCECODE
23	Computer-Aided Design	adCAD
24	BI and analysis tools	adANALYTICS
25	Scientific data	adSCIENTIFIC
26	Geographic Info System	adGIS

Minor Formats

Attribute Number	Minor Format
00	Minor format not defined
01	Standard
02	Book
03	Chart
04	Macro
05	Text
06	Binary
07	PC
08	Windows
09	DOS
10	Macintosh
11	RGB
12	TIFF
13	IFF
14	Experimental
15	Format Information
16	RLE
17	Symbol
18	Old
19	Footnote
20	Style
21	Palette
22	Configuration
23	Activity
24	Resource
25	Calculation

Minor Formats, continued

Attribute Number	Minor Format
26	Glossary
27	Spelling
28	Thesaurus
29	Hyphenation
30	Miscellaneous
31	UNIX
32	VAX
33	Driver
34	Archive

Appendix G: Files Required for Redistribution

This section lists the Export files that can be redistributed in your applications under the licensing agreement. Unless noted, these files are in the directory *install\OS\bin*, where *install* is the path of the Export installation directory and *OS* is the operating system platform.

- [Core Files](#) 462
- [Support Files](#) 463
- [Document Readers and Writers](#) 465

NOTE: On Windows systems, the libraries are .dll files. On UNIX systems, the libraries are .so, .a, or .sl files.

Core Files

The following core files can be redistributed with your application.

File	Description
formats_e.ini	Initialization file. For more information on this file, see Determine Format Support, on page 454 .
htmlexport.	Required by the Java API.
htmserv.dll	The in-process version of the HTML Export COM interface.
htmserv.exe	The out-of-process version of the HTML Export COM interface.
htmconv.*	HTML converter for the document token stream.
KeyView.jar	Interface for Java support. NOTE: This file can be found at the path <i>install/javaapi/KeyView.jar</i> where <i>install</i> is the Export SDK installation directory.
kpifcnvt.*	Graphic conversion routines.
kpifutil.*	Graphic utility routines.
kvdecrypt.*	Decryption utility functions
kvxtract.*	File Extraction interface.
kvhtml.*	HTML Export C API.

File	Description
kvexport.*	Export C API. Interface to the HTML and XML Export C APIs.
kvexportdotnet.*	Interface for .NET support.
kvolefio.*	Embedded OLE object writer.
kvutil.*	Internal KeyView utility functions.
kvxpgsa.*	Interface between presentations or graphic readers and the Export API.
kvxssa.*	Interface between spreadsheet readers and the Export API.
kvxwpsa.*	Interface between word processing readers and the Export API.
kvzip.*	Zip writer
kwad.*	File auto-recognition module.
regsvr32.exe	A Microsoft Windows program used to register in-process COM objects.
txtcnv.*	Converter for document token stream.
xmlexport.	Required by the Java API.
vcredist*	(Windows platforms only) Microsoft Visual C++ Redistributable Packages. NOTE: This folder can be found in the Export SDK installation directory.

Support Files

The following support files can be redistributed with your application.

File	Description
datafiles*	(Folder) Required by kvlangdetect.
NSFtemplates*	(Folder) Templates used by nsfsr to format Lotus mail notes.
7z.*	Required by z7zsr and multiarcsr.
bentofio.*	Required by 1123sr.* and kpprzrdr.*.
cbmap.map	Character mappings for Adobe Portable Document Format (PDF).
CEBDLL.dll	Required by cebsr.
chartbls.ux	Character mapping tables.
chmdll.*	Required by chmsr.

File	Description
codeidentifierplugin.*	Required for source code identification.
cpstdk*	Required by pstxsr.
DFECore.dll	Required by cebsr.
Filter.dll	Required by cebsr.
kp3dwrld.*	Required for 3D charts.
kpchtrdr.*	Required for all spreadsheets (chart support).
kpjavwrt.*	Java utility routines.
kpjpeg.*	JPEG file interchange format shared routines.
kppng.*	Portable Network Graphics (PNG) utilities.
kvlangdetect.*	Utility functions for language and character set detection.
kvxconfig.ini	Contains element extraction settings for source XML files.
kvgraph.*	Required for all spreadsheets (chart support).
kvpie.*	Required for all spreadsheets (chart support).
kvradar.*	Required for all spreadsheets (chart support).
kv.lic	Contains license information for KeyView products. This file is opened and validated when a KeyView API is used.
kvraster.class	Java program used to convert vector graphics on UNIX and Linux.
kvthread.*	Required for multithreaded out-of-process functionality.
kvVector.class	Java applet used to convert vector graphics on UNIX and Linux.
kvvector.jar	Java applet used to convert vector graphics on UNIX and Linux. This must reside in the output directory.
langdetecttext.	Required by kvlangdetect.*
libcrypto*	SSL utility functions used by KeyView mail format readers.
libpff.*	Required by pffsr.
libstlport.so.1	(Solaris platforms only) Solaris Studio Redistributable. This file is located in <i>install/OS/lib</i> .
oleaut32.*	Microsoft OLE Automation Controls.
olepro32.*	Microsoft OLE property support library.
servant.*	Executable required for out-of-process conversions.

File	Description
unzipjpg.*	Required for JPEG decompression.
wpmap.*	Extended character mapping for WordPerfect and Corel Presentation.
xmlsh.*	Contains a library of content handlers for each XML file type. Required by the Expat XML parser.

Document Readers and Writers

The following readers and writers can be redistributed with your application.

File	Description
ad1sr.*	AD1 Evidence file reader
afsr.*	ASCII reader
assr.*	Applix spreadsheet reader
awsr.*	Applix Words reader
bkfsr.*	Microsoft Backup File reader
bmpsr.*	Windows bitmap (BMP) reader
bzip2sr.*	Bzip2 reader
cabsr.*	Microsoft Cabinet format reader
cebsr.*	Founder Chinese E-paper Basic reader
chmsr.*	Microsoft Compiled HTML Help reader
csvsr.*	Comma-Separated Values reader
dbfsr.*	dBase Database reader
dbxsr.*	Microsoft Outlook Express DBX reader
dcasr.*	Document Content Architecture/Revisable Form Text (DCA/RFT) reader
difsr.*	Data Interchange Format reader
dmgsr.*	Mac Disk Copy Disk Image File reader
dw4sr.*	DisplayWrite 4 reader
dx1sr.*	Domino XML Language reader
em1sr.*	Microsoft Outlook Express (EML) reader. This is used to convert EML files when

File	Description
	the MBX reader is not licensed.
emxsr.*	Legato EMailXtender archive (EMX) reader
encasesr.*	Expert Witness Compression Format (EnCase) v6 reader
encase2sr.*	Expert Witness Compression Format (EnCase) v7 reader
entsr.*	Microsoft Entourage Database Format reader
epubsr.*	Open Publication Structure eBook reader
foliosr.*	Folio Flat File reader
gdsiisr.*	Graphic Database System (GDSII) reader
gifsr.*	Graphics Interchange Format (GIF) reader
gwfssr.*	GroupWise FileSurf reader
h17sr.*	Health level7 reader (metadata only)
htmsr.*	HTML and XHTML reader
hwposr.*	Hangul 2002, 2005, 2007 reader
hwpsr.*	Hangul 97 reader
ichatsr.*	Apple iChat Log reader
icssr.*	Microsoft Outlook iCalendar reader
isosr.*	ISO-9660 CD Disc Image Format reader
iwss13sr.*	iWork 13 Numbers reader
iwsssr.*	Apple iWork Numbers reader
iwvp13sr.*	iWork 13 Pages reader
iwwpsr.*	Apple iWork Pages reader
jp2000sr.*	JPEG 2000 metadata reader
jpgsr.*	JPEG metadata reader
jtdsr.*	JustSystems Ichitaro reader
kpagrdr.*	Applix Presents reader
kpanidr.*	Animated cursor reader
kpbmprdr.*	Windows Bitmap reader
kpbmpwrt.*	Windows Bitmap writer

File	Description
kpcdrdr.*	Corel Draw
kpcgmrdr.*	Computer Graphics Metafile reader
kpcgmwrt.*	Computer Graphics Metafile writer
kpdcxrdr.*	DCX (fax) reader
kpdwgrdr.*	AutoCAD Drawing format reader
kpdxfdrdr.*	AutoCAD Drawing Exchange format reader
kpemfrdr.*	Enhanced Metafile reader
kpemfwrt.*	Enhanced Metafile writer
kpepsrdr.*	Encapsulated PostScript (EPS) reader
kpgflrdr.*	OmniGraffle Picture reader
kpgifdrdr.*	Graphic Interchange Format (GIF) reader
kpgifwrt.*	Graphic Interchange Format (GIF) writer
kpicodrdr.*	Windows Icon reader
kpiwgrdr.*	Apple iWork Keynote reader
kpiwpg13rdr.*	Apple iWork Keynote 13 reader
kpjbig2rdr.*	JBIG2 reader
kpjp2000rdr.*	JPEG 2000 reader
kpjpgdrdr.*	JPEG file interchange format reader
kpjpgwrt.*	JPEG file interchange format writer
kpmacrdr.*	MacPaint reader
kpsodrdr.*	Microsoft Office Drawing Objects (office 97, 2000, and XP) reader
kpnbmrdr.*	IBM Notes Bitmap reader (for embedded images in DXL files)
kpodfrdr.*	Oasis Open Document Format presentation (ODP) reader
kpodardr.*	AutoCAD reader (Windows only)
kpoxdrdr.*	Open Office XML Diagram Graphics reader
kpp40rdr.*	Microsoft PowerPoint PC 4.0 and PowerPoint Mac reader
kpp95rdr.*	Microsoft PowerPoint 95 reader
kpp97rdr.*	Microsoft PowerPoint 97 and higher reader

File	Description
kppctrdr.*	Macintosh Quick Draw Picture (PICT) reader
kppcxrdr.*	PC Paintbrush (PCX) reader
kppdfdrdr.*	Adobe Portable Document File (PDF) graphic-based reader
kppdf2rdr.*	High-fidelity Adobe Portable Document File (PDF) graphic-based reader
kppicrdr.*	Pictor PC Paint format (PIC) reader
kppngrdr.*	Portable Network Graphics (PNG) reader
kppngwrt.*	Portable Network Graphics (PNG) writer
kpppxrdr.*	Microsoft PowerPoint XML reader 2007
kpprerdr.*	Lotus Freelance Graphics for Windows V2.0 reader
kpprzrdr.*	Lotus Freelance Graphics 96/97/98 reader
kprawrdr.*	ODA Internal Raster (RAW) Picture reader
kpsddrdr.*	StarOffice Draw / Impress reader
kpsdwrdr.*	Lotus Ami Pro Graphics reader
kpsgirdr.*	SGI RGB reader
kpshwrdr.*	Corel Presentations reader
kpsprdr.*	Shape Stream reader
kpsvgwrt.*	Scalable Vector Graphics (SVG) writer
kpsunrdr.*	Sun Raster reader
kptgardr.*	Truevision Targa reader
kptifrdr.*	Tagged Image File Format (TIFF) reader
kpvsd2rdr.*	Microsoft Visio reader
kpvsdxrdr.*	Microsoft Visio 2013 reader
kpwg2rdr.*	WordPerfect Graphics 2 reader
kpwmfrdr.*	Windows Metafile reader
kpwmfwrt.*	Windows Metafile writer
kpwpgdrdr.*	WordPerfect Graphics 1 reader
kpxfd1rdr.*	Extensible Forms Description Language reader
kvgzsr.*	GZIP reader

File	Description
kvhqxsr.*	BinHex reader
kvzeesr.*	UNIX Compress reader
l123sr.*	Lotus 123 v96/97/98 reader
lasr.*	Lotus AMI Pro reader
ltbenn30.dll	Lotus Word Pro support (supported on Windows x86 platform only)
ltscsn10.dll	Lotus Word Pro support (supported on Windows x86 platform only)
lwpapin.dll	Lotus Word Pro support (supported on Windows x86 platform only)
lwppann.dll	Lotus Word Pro support (supported on Windows x86 platform only)
lwpsr.dll	Lotus Word Pro reader (supported on Windows x86 platform only)
lzhsr.*	Microsoft Compression Folder reader
macbinsr.*	MacBinary reader
mbsr.*	Microsoft Word Macintosh reader
mbxsr.*	Mailbox (MBX) ¹ and Microsoft Outlook Express (EML) reader
mbsr.*	Microsoft Access reader.
mhtsr.*	MIME HTML reader
mifsr.*	Adobe Maker Interchange Format reader
misr.*	Microsoft Word 2 reader
mp3sr.*	MP3 reader for metadata extraction
mppsрr.*	Microsoft Project reader
msgsr.*	Microsoft Outlook (MSG) reader
mspubsr.*	Microsoft Publisher reader
msw6sr.*	Microsoft Works 6 and 2000 reader
mswsr.*	Microsoft Works V1 and 2 reader
multiarcсr.*	ARJ reader
mw6sr.*	Microsoft Word 95 reader

¹This reader is an advanced feature and is sold and licensed separately from KeyView Export SDK.

File	Description
mw8sr.*	Microsoft Word 97, 2000, and XP reader
mwsr.*	Microsoft Word for DOS and Microsoft Write reader
mwssr.*	Microsoft Works Spreadsheet reader
mwxsr.*	Microsoft Word 2007 XML reader
nsfsr.*	IBM Notes Database reader ¹
oa2sr.*	Fujitsu Oasys reader
odfssr.*	Oasis Open Document Format spreadsheets (ODS) reader
odfwpsr.*	Oasis Open Document Format word processing (ODT) reader
olesr.*	Embedded OLE object reader.
olmsr.*	Microsoft Outlook for Macintosh reader
onealtsr.*	Microsoft OneNote Alternate Format reader
onesr.*	Microsoft OneNote Format reader
onmsr.*	Legato EMailXtender Native Message reader
oo3sr.*	Omni Outliner reader
pbixsr.*	Microsoft Power BI file (PBIX) reader
pdf2sr.*	Alternative Adobe Portable Document Format file (PDF) reader
pdfsr.*	Adobe Portable Document File (PDF) reader
pffsr.*	Microsoft Outlook Offline Storage File reader
pfilesr.*	Microsoft Rights Management System encryption file reader
pngsr.*	Portable Network Graphics (PNG) reader
pstsr.dll	Microsoft Outlook Personal Folders file MAPI-based reader (supported on Windows platform only) ²
pstnsr.*	Microsoft Outlook Personal Folders file native reader ³
pstxsr.*	Microsoft Outlook Personal Folders file native reader ⁴

¹This reader is an advanced feature and is sold and licensed separately from KeyView Export SDK.

²This reader is an advanced feature and is sold and licensed separately from KeyView Export SDK.

³This reader is an advanced feature and is sold and licensed separately from KeyView Export SDK.

⁴This reader is an advanced feature and is sold and licensed separately from KeyView Export SDK.

File	Description
qpssr.*	Quattro Pro spreadsheet reader
rarsr.*	RAR Archive reader
rtfsr.*	Microsoft Rich Text Format reader
skypesr.*	Skype log file reader
sosr.*	StarOffice/OpenOffice reader
starcsr.*	StarOffice Calc reader
starwsr.*	StarOffice Writer reader
swfsr.*	Macromedia Flash reader
tarsr.*	Tape archive reader
tifsr.*	TIFF reader (metadata only)
tnefsr.*	Transfer Neutral Encapsulation Format reader
unihtmsr.*	Unicode HTML reader
unisr.*	Unicode reader
unzip.*	Zip file reader
uudsr.*	UUEncoding reader
vsdsr.*	Microsoft Visio reader
vcfsr.*	Microsoft Outlook vCard Contact reader
wkssr.*	Lotus 1-2-3 v2.0 through 5.0 reader
wosr.*	WordPerfect 5.x reader
wp6sr.*	WordPerfect 6.0 through 10.0 reader
wpmsr.*	WordPerfect for Macintosh reader
xlsbsr.*	Microsoft Office 2007 Excel Binary Format reader
xlssr.*	Microsoft Excel reader
xlsxsr.*	Microsoft Excel 2007 XML reader
xmlsr.*	Generic XML reader
xpssr.*	XML Paper Specification reader
xywsr.*	XYWrite reader
yimsr.*	Yahoo! Instant Messenger reader

File	Description
z7zsr.*	7-Zip reader

Appendix H: Password Protected Files

This section lists supported password-protected container and non-container files and describes how to open them.

- [Supported Password Protected File Types](#) 473
- [Open Password Protected Container Files](#) 474
- [Export Password Protected Files](#) 474

Supported Password Protected File Types

The following table lists the password-protected file types that KeyView supports.

Key to support table

Symbol	Description
Y	Format is supported.
N	Format is not supported.
S	Support for viewing subfiles.
V	Support for viewing content.
P	Password required.
C	Password and certificate or User ID file required.

Supported password-protected file types

File Type	Version	Filter	Export	Extract	View	Credentials
PST (Windows)	n/a	N	N	Y	S	P
PST (non-Windows) ¹	n/a	N	N	Y	S	N
ZIP	n/a	N	N	Y	S	P
7-Zip	n/a	N	N	Y	S	P

¹The native PST readers, pstxsr and pstnsr, do not require credentials to open password-protected PST files that use compressible encryption.

Supported password-protected file types, continued

File Type	Version	Filter	Export	Extract	View	Credentials
RAR	n/a	N	N	Y	S	P
SMIME in MSG, EML, MBX	n/a	N	N	Y	N	C
Lotus Notes NSF	n/a	N	N	Y	N	C
Adobe PDF	n/a	Y	Y	Y	V	P
Microsoft Office	97-2003 2007 2010	Y	Y	Y	V	P

Open Password Protected Container Files

This section describes how to extract password-protected container files using the C API. The following guidelines apply to specific file types.

- **Notes NSF files.** If you are running a Notes client with an active user connected to a Domino server, you must specify the user's password as a credential regardless of whether the NSF files you are opening are protected. This enables KeyView to access the Notes client and the IBM Notes API. If the Notes client is not running with an active user, KeyView does not require credentials to access the client.
- **PST files.** To open password-protected PST files that use high encryption (Microsoft Outlook 2003 only), you must use the MAPI-based PST reader (`pstsr`). The native PST readers (`pstxsr` and `pstnsr`) do not support files that use high encryption and return the error message `KVERR_PasswordProtected` if a PST file is encrypted with high encryption.

To open container files

1. Define the credential information in the `KVOpenFileArg` data structure. See [KVOpenFileArg](#), on page 160.
2. Pass `KVOpenFileArg` to the `fpOpenFile()` function. See [fpOpenFile\(\)](#), on page 149.
3. Call `fpCloseFile()`. See [fpCloseFile\(\)](#), on page 141.

Export Password Protected Files

This section describes how to export password-protected non-container files with the C API.

To export password-protected files

1. Call the `fpInit()` or `fpInitWithLicenseData()` function.
2. Call the `KVHTMLConfig()` function with the following arguments :

Argument	Parameter
<code>nType</code>	<code>KVCFG_SETPASSWORD</code>
<code>nValue</code>	<code>TRUE</code>
<code>pData</code>	The source file password. The password is a null-terminated string with a maximum length of 255 characters (the final byte is null).

For example:

```
(*fpHTMLConfig)(pKVHTML, KVCFG_SETPASSWORD, TRUE, password);
```

where `password` is a null-terminated string of 255 or fewer characters.

3. Call the `fpConvertStream()` or `KVHTMLConvertFile()` function.

Appendix I: Microsoft Rights Management Service Protected Files

This section contains information about KeyView support for Microsoft Rights Management Service (RMS).

- [Microsoft Azure Rights Management Service](#) 476
- [Supported Formats](#) 477

Microsoft Azure Rights Management Service

The Microsoft Rights Management Service (RMS) allows you to classify and optionally encrypt documents. This service forms the rights management part of Microsoft Azure Information Protection (AIP).

For many of the files that Azure RMS can classify and encrypt, KeyView can identify whether they have been encrypted with RMS encryption. It can also extract metadata (including the RMS classification) and XrML associated with the document.

For the KeyView HTML Export C SDK, you can provide the credentials required to access protected files by using the `fpConfigureRMS` function (see [fpConfigureRMS\(\)](#), on page 170). This function allows the HTML Export and File Extraction API functions to operate on the protected data of the file. This functionality is available only when running in process.

When you use Azure RMS decryption, consider the following notes:

- Azure RMS decryption is licensed as an additional product. If your license does not allow for Azure RMS decryption, this function returns the extended error code `KVError_ReaderUsageDenied`.
- To access the protected content, KeyView must make an HTTP request. The time required to do so means that KeyView processes protected files slower than unprotected files.
- By default, KeyView uses the system proxy when it makes HTTP requests to obtain the key. You can also specify the proxy manually in the configuration file. See [Configure the Proxy for RMS](#), on page 120.
- This function is supported only on Windows 64-bit, Linux 64-bit, Solaris SPARC 64-bit, and Solaris x86 64-bit. On Linux 64-bit, the minimum supported versions of particular distributions are:
 - Red Hat Enterprise Linux (RHEL) 6
 - CentOS 6
 - SuSE Linux Enterprise Server (SLES) 12

CAUTION: When HTML Export or File Extraction API functions access the protected contents of

Azure RMS-protected files, KeyView may place decrypted contents into the temporary directory. If you want to manage the security of such files, you might want to change the temporary directory, by using [KVHTMLConfig\(\)](#).

RMS Credentials

For KeyView to access the protected contents of Microsoft Azure Rights Management System (RMS) protected files, your end-user application must be registered on the relevant Azure domain. For more information about how to register an app, refer to the Microsoft documentation: <https://docs.microsoft.com/en-us/azure/active-directory/develop/quickstart-register-app>.

After you register an application, you can find the client and tenant IDs in the Azure Portal, in the Overview section. You can find the client secret in the Certificates & Secrets section.

CAUTION: This information is linked to the domain itself, rather than to a specific user. Providing this information allows KeyView to access the contents of all files protected by this domain. Therefore you must handle these three pieces of information securely.

Supported Formats

KeyView support for Azure RMS files depends on the encryption method that Azure RMS uses for each file type, and on whether the file is classified or protected. In Azure RMS, classified files have additional labels to inform users of their sensitivity, while protected files are encrypted so that only authorized users can view them.

In some cases, KeyView format detection returns a different file type depending on whether the file is classified or protected.

The following sections provide information about the Azure RMS support for different file types, and metadata support.

For more information about XrML extraction, see the `subFileType` member of the [KVSubFileInfo](#) structure.

Microsoft Office Files

The following table describes KeyView detected formats for Microsoft Office files that Azure RMS encrypts by creating an OLE container.

For these files:

- KeyView can get classification metadata.
- KeyView can detect whether the file is Azure RMS encrypted (the `kwindowsRMSEncrypted` flag).
- When you configure credentials through `fpConfigureRMS`, HTML Export and File Extraction API

functions can operate on the protected data of the file (see [fpConfigureRMS\(\)](#), on page 170). In this case, you can export, extract, and get summary information.

In most cases, KeyView can also extract the XrML file for these files when they are protected, and identify the XrML files as `KVSubFileType_XrML`.

File extensions	Format detected when file is classified but not protected	Format detected when file is protected	XrML extraction
docx, dotx	MS_Word_2007_Fmt	MS_Office_2007_Fmt	Yes
docm, dotm	MS_Word_Macro_2007_Fmt	MS_Office_2007_Fmt	Yes
pptx, potx, ppsx	MS_PPT_2007_Fmt	MS_Office_2007_Fmt	Yes
pptm, potm, ppsm	MS_PPT_Macro_2007_Fmt	MS_Office_2007_Fmt	Yes
vsdx	MS_Visio_2013_Fmt	MS_Office_2007_Fmt	Yes
vsdm, vssm, vssx, vstm, vstx	MS_Visio_2013_Macro_Fmt MS_Visio_2013_Stencil_Fmt MS_Visio_2013_Stencil_Macro_Fmt MS_Visio_2013_Template_Fmt MS_Visio_2013_Template_Macro_Fmt	MS_Office_2007_Fmt	Yes
xlsx, xltx	MS_Excel_2007_Fmt	MS_Office_2007_Fmt	Yes
xlsm, xlsb, xltm	MS_Excel_Macro_2007_Fmt MS_Excel_Binary_2007_Fmt	MS_Office_2007_Fmt	Yes
xps	MS_XPS_Fmt	MS_Office_2007_Fmt	Yes
doc, dot	MS_Word_95_Fmt MS_Word_97_Fmt MS_Word_2000_Fmt	MS_Word_95_Fmt MS_Word_97_Fmt MS_Word_2000_Fmt	Yes
ppt, pot, pps	PowerPoint_95_Fmt PowerPoint_97_Fmt	PowerPoint_95_Fmt PowerPoint_97_Fmt	Yes
xls, xla, xlam, xlt	Excel_Fmt Excel_Macro_Fmt Excel_95_Fmt Excel_97_Fmt Excel_2000_Fmt	Excel_Fmt Excel_Macro_Fmt Excel_95_Fmt Excel_97_Fmt Excel_2000_Fmt	Yes

Implemented as pFile

The following table describes the KeyView detected formats for files that Azure RMS encrypts by creating a pFile around the document.

For these files:

- KeyView can get classification metadata.
- KeyView can detect whether the file is Azure RMS encrypted (the `kwindowsRMSEncrypted` flag).
- KeyView can extract the XrML if the file is protected.
- When you configure credentials through `fpConfigureRMS`, HTML Export and File Extraction API functions can operate on the protected data of the file (see [fpConfigureRMS\(\)](#), on page 170). In this case, you can export, extract, and get summary information.

File extensions	Format detected when file is classified but not protected	Format detected when file is protected	Notes
pfile	n/a	RMS_Protected_Fmt	
vsd	MS_Visio_Fmt	RMS_Protected_Fmt	
vdw, vss, vst	MS_Visio_Fmt	RMS_Protected_Fmt	
mpp, mpt	MS_Project_4_Fmt MS_Project_41_Fmt MS_Project_98_Fmt MS_Project_2000_Fmt MS_Project_2007_Fmt	RMS_Protected_Fmt	
pub	MS_Publisher_98_Fmt	RMS_Protected_Fmt	
jpg	JPEG_File_Interchange_Fmt	RMS_Protected_Fmt	Protected format has extension pjpg. When classified but not protected, the classification metadata is XMP.
png	PNG_Fmt	RMS_Protected_Fmt	Protected format has extension ppng.
gif	GIF_89a_Fmt	RMS_Protected_Fmt	Protected format has extension pgif.

File extensions	Format detected when file is classified but not protected	Format detected when file is protected	Notes
			When classified but not protected, the classification metadata is XMP.
tif	TIFF_Fmt	RMS_Protected_Fmt	Protected format has extension ptif. When classified but not protected, the classification metadata is XMP.
dng	TIFF_Fmt	RMS_Protected_Fmt	When classified but not protected, the classification metadata is XMP.
dwx	MS_XPS_Fmt	RMS_Protected_Fmt	When classified but not protected, dwfx is detected and treated as XPS.
psd, psb	PSD_Fmt	RMS_Protected_Fmt	When classified but not protected, the classification metadata is XMP.

PDF Files

The following table describes the KeyView detected formats for PDF documents, which Azure RMS encrypts by creating an encrypted PDF (in which each stream and metadata value is encrypted), wrapped in a container PDF. KeyView allows you to extract the encrypted PDF from the container, and then for the extracted file:

- KeyView can detect whether the file is Azure RMS encrypted (the `kwindowsRMSEncrypted` flag).
- KeyView can extract the XrML if the file is protected.
- When you configure credentials through `fpConfigureRMS`, HTML Export and File Extraction API functions can operate on the protected data of the file (see `fpConfigureRMS()`, on page 170). In this case you can export, extract, and get summary information for PDF formats.

File extensions	Format detected when file is classified but not protected	Format detected when file is protected
pdf	PDF_Fmt PDF_Portfolio_Fmt	PDF_Fmt PDF_Portfolio_Fmt

Restricted Permission Messages

Email clients such as Microsoft Outlook can protect email messages as rights-managed email messages. In these cases, it stores the contents of the original message as an encrypted `rmsg` attachment. KeyView does not support detection or processing of these encrypted attachments.

Send documentation feedback

If you have comments about this document, you can [contact the documentation team](#) by email. If an email client is configured on this system, click the link above and an email window opens with the following information in the subject line:

Feedback on Micro Focus IDOL KeyView 12.9 HTML Export SDK C and COM Programming Guide

Add your feedback to the email and click **Send**.

If no email client is available, copy the information above to a new message in a web mail client, and send your feedback to swpdl.idoldocsfeedback@microfocus.com.

We appreciate your feedback!