



## VisiBroker 8.5.2

---

A decorative graphic consisting of several overlapping, wavy blue lines that create a sense of motion and depth, starting from the right side and curving towards the left.

VisiBroker for Java  
Developer's Guide

Micro Focus  
The Lawn  
22-30 Old Bath Road  
Newbury, Berkshire RG14 1QN  
UK

<http://www.microfocus.com>

Copyright © Micro Focus 2009-2014. All rights reserved. VisiBroker contains derivative works of Borland Software Corporation, Copyright 1992-2010 Borland Software Corporation (a Micro Focus company).

MICRO FOCUS, the Micro Focus logo and Micro Focus Licensing are trademarks or registered trademarks of Micro Focus IP Development Limited or its subsidiaries or affiliated companies in the United States, United Kingdom and other countries.

BORLAND, the Borland logo and VisiBroker are trademarks or registered trademarks of Borland Software Corporation or its subsidiaries or affiliated companies in the United States, United Kingdom and other countries.

All other marks are the property of their respective owners.

2014-08-20

# Contents

<b>Introduction to VisiBroker .....</b>	<b>1</b>
Accessing VisiBroker online help topics in the standalone Help Viewer .....	1
Accessing VisiBroker online help topics from within a VisiBroker GUI tool.....	1
Documentation conventions.....	1
Platform conventions.....	2
Contacting Micro Focus .....	2
Further Information and Product Support .....	2
Information We Need .....	2
Contact information .....	3
<b>Understanding the CORBA model.....</b>	<b>5</b>
What is CORBA? .....	5
What is VisiBroker? .....	6
VisiBroker Features .....	6
VisiBroker's Smart Agent (osagent) Architecture .....	6
Enhanced Object Discovery Using the Location Service .....	7
Implementation and Object Activation Support .....	7
Robust thread and connection management .....	7
IDL compilers.....	7
Dynamic invocation with DII and DSI .....	8
Interface and implementation repositories.....	8
Server-side portability.....	8
Customizing the VisiBroker ORB with interceptors and object wrappers .....	8
Event Queue .....	9
Backing stores in the Naming Service .....	9
Defining interfaces without IDL.....	9
GateKeeper.....	9
VisiBroker CORBA compliance .....	9
VisiBroker Development Environment .....	9
Programmer's tools.....	10
CORBA services tools.....	10
Administration Tools.....	10
Java Development Environment .....	10
Java 2 Standard Edition .....	10
Java Run-time Environment .....	11
What's Required for GateKeeper .....	11
Java-enabled Web browser.....	11
Interoperability with VisiBroker .....	11
Interoperability with other ORB products.....	11
IDL to Java mapping .....	12
<b>Developing an example application with VisiBroker .....</b>	<b>13</b>
Development process .....	13
Step 1: Defining object interfaces .....	14
Writing the account interface in IDL .....	14
Step 2: Generating client stubs and server servants .....	15
Files produced by the idl compiler .....	15
Step 3: Implementing the client.....	16
Client.java .....	16
Binding to the AccountManager object.....	17
Obtaining an Account object .....	17
Obtaining the balance .....	17
AccountManagerHelper.java.....	17
Other methods.....	17
Step 4: Implementing the server .....	18

Server programs .....	18
Step 5: Building the example .....	19
Compiling the example .....	19
Step 6: Starting the server and running the example .....	19
Starting the Smart Agent .....	19
Starting the server .....	19
Running the client .....	20
Deploying applications with VisiBroker .....	20
VisiBroker Applications .....	21
Deploying applications .....	21
Environment variables .....	21
Support service availability .....	21
Using vbj .....	22
Running the application .....	22
Executing client applications .....	22
Executing server applications in Java .....	23

## **Programmer tools for Java ..... 25**

Options .....	25
General options .....	25
idl2ir .....	26
ir2idl .....	27
idl2java .....	27
java2idl .....	29
java2iiop .....	30
vbj .....	33
vbjc .....	34
Specifying the classpath .....	35
Specifying the JVM .....	35
idl2wsj .....	35

## **IDL to Java mapping ..... 37**

Names .....	37
Reserved names .....	37
Reserved words .....	38
Modules .....	38
Basic types .....	38
IDL type extensions .....	39
Holder classes .....	39
Java null .....	42
Boolean .....	43
Char .....	43
Octet .....	43
String .....	43
WString .....	43
Integer types .....	43
Floating point types .....	43
Helper classes .....	44
Constants .....	45
Constants within an interface .....	45
Constants NOT within an interface .....	45
Constructed types .....	46
Enum .....	46
Struct .....	47
Union .....	48
Sequence .....	50
Array .....	51

Interfaces .....	52
Abstract interfaces .....	53
Local interfaces .....	54
Passing parameters .....	54
Server implementation with inheritance .....	55
Server implementation with delegation .....	56
Interface scope .....	57
Mapping for exceptions .....	57
User-defined exceptions .....	57
System exceptions .....	58
Mapping for the Any type .....	58
Mapping for certain nested types .....	58
Mapping for Typedef .....	59
Simple IDL types .....	59
Complex IDL types .....	59

## **VisiBroker properties..... 61**

JAVA RMI over IIOP properties .....	61
Smart Agent properties .....	62
Smart Agent communication properties .....	63
VisiBroker ORB properties .....	65
POA properties .....	72
Server Manager properties .....	73
Properties showing run-time status of Server .....	73
Properties related to Server-side resource usage .....	73
Properties related to Client-side resource usage .....	74
Properties related to the Smart Agent (osagent) .....	74
Location Service properties .....	74
Event Service properties .....	74
Naming Service (VisiNaming) properties .....	75
Properties relating to object clustering .....	76
VisiNaming service cluster related properties .....	76
Pluggable Backing Store Properties .....	77
Default properties common to all adapters .....	77
JDBC Adapter properties .....	78
DataExpress Adapter properties .....	79
JNDI adapter properties .....	79
VisiNaming Service Security-related properties .....	80
OAD properties .....	80
Interface Repository properties .....	81
Client-side IIOP connection properties .....	81
URL Naming properties .....	82
QoS-related Properties .....	82
Server-side server engine properties .....	83
Server-side thread session IIOP_TS/IIOP_TS connection properties .....	83
Server-side thread session BOA_TS/BOA_TS connection properties .....	84
Server-side thread pool IIOP_TP/IIOP_TP connection properties .....	84
Server-side thread pool BOA_TP/BOA_TP connection properties .....	85
Properties that support bi-directional communication .....	85
Debug Logging Properties .....	86
Enabling and filtering .....	87
Appending and logging .....	88
Deprecated properties .....	89
Setting properties in an applet .....	89
Web services run-time properties .....	89
Web services HTTP Listener properties .....	89
Web services Connection Manager properties .....	90

SOAP Request Dispatcher properties .....	90
Getting the ORB version programmatically .....	90
<b>Handling exceptions .....</b>	<b>93</b>
Exceptions in the CORBA model.....	93
System exceptions .....	93
SystemException class.....	94
Obtaining completion status .....	94
Catching system exceptions.....	94
Downcasting exceptions to a system exception.....	95
Catching specific types of system exceptions .....	95
User exceptions .....	96
Defining user exceptions .....	96
Modifying the object to raise the exception .....	97
Catching user exceptions .....	97
Adding fields to user exceptions .....	98
<b>Server basics .....</b>	<b>99</b>
Overview.....	99
Initializing the VisiBroker ORB.....	99
Creating the POA.....	99
Obtaining a reference to the root POA.....	100
Creating the child POA .....	100
Implementing servant methods.....	101
Creating and Activating the Servant.....	102
Activating the POA .....	102
Activating objects.....	102
Waiting for client requests .....	103
Complete example.....	103
<b>Using POAs .....</b>	<b>105</b>
What is a Portable Object Adapter?.....	105
POA terminology .....	106
Steps for creating and using POAs .....	106
POA policies.....	106
Creating POAs.....	109
POA naming convention .....	109
Obtaining the rootPoa .....	109
Setting the POA policies .....	110
Creating and activating the POA.....	110
Activating objects.....	110
Activating objects explicitly.....	111
Activating objects on demand .....	111
Activating objects implicitly .....	112
Activating with the default servant.....	112
Deactivating objects .....	113
Using servants and servant managers .....	114
ServantActivators.....	115
ServantLocators.....	118
Managing POAs with the POA manager .....	120
Getting the current state.....	120
Holding state .....	120
Active state .....	121
Discarding state.....	121
Inactive state .....	121
Listening and Dispatching: Server Engines, Server Connection Managers, and their properties .....	122

Server Engine and POAs .....	122
Associating a POA with a Server Engine .....	123
Defining Hosts for Endpoints for the Server Engine.....	124
Server Connection Managers .....	124
Manager.....	125
Listener.....	125
Dispatcher.....	126
When to use these properties .....	126
Adapter activators.....	128
Processing requests .....	128

## **Managing threads and connections ..... 131**

Using threads .....	131
Listener thread, dispatcher thread, and worker threads.....	132
Thread policies .....	132
Thread pool policy.....	132
Thread-per-session policy .....	135
Connection management .....	136
PeerConnectionCurrent Interface.....	137
ServerEngines .....	138
ServerEngine properties .....	138
Setting dispatch policies and properties .....	139
Thread pool dispatch policy .....	139
Thread-per-session dispatch policy.....	141
Coding considerations .....	141
Setting connection management properties .....	141
Valid values for applicable properties.....	142
Effects of property changes.....	143
Dynamically alterable properties .....	143
Determining whether property value changes take effect.....	143
Impact of changing property values .....	143
High scalability configuration for VisiBroker for Java (using Java NIO) .....	144
Garbage collection .....	144
How ORB garbage collection works.....	144
Properties related to ORB garbage collection .....	145

## **Using the tie mechanism ..... 147**

How does the tie mechanism work?.....	147
Example program .....	147
Location of an example program using the tie mechanism .....	147
Changes to the server class .....	148
Changes to the AccountManager .....	149
Changes to the Account class .....	150
Building the tie example .....	150

## **Client basics ..... 151**

Initializing the VisiBroker ORB .....	151
Binding to objects .....	151
Action performed during the bind process .....	151
Invoking operations on an object .....	152
Manipulating object references .....	152
Converting a reference to a string.....	153
Obtaining object and interface names.....	153
Determining the type of an object reference.....	153
Determining the location and state of bound objects.....	154
Narrowing object references.....	154
Widening object references .....	154

Using Quality of Service (QoS) .....	155
Understanding Quality of Service (QoS) .....	155
Policy overrides and effective policies.....	155
QoS interfaces .....	155
org.omg.CORBA.Object.....	155
com.inprise.vbroker.CORBA.Object .....	156
org.omg.CORBA.PolicyManager .....	156
org.omg.CORBA.PolicyCurrent .....	156
com.inprise.vbroker.QoSExt.DeferBindPolicy .....	157
com.inprise.vbroker.QoSExt.	
ExclusiveConnectionPolicy .....	157
com.inprise.vbroker.QoSExt.RelativeConnectionTimeoutPolicy .....	158
org.omg.Messaging.RebindPolicy.....	158
org.omg.CORBA.Messaging.RelativeRequestTimeout	
Policy .....	160
org.omg.CORBA.Messaging.RelativeRoundTripTimeout	
Policy .....	161
org.omg.CORBA.Messaging.SyncScopePolicy .....	161
Exceptions .....	162
Code Set support .....	162
Types of Code Sets.....	162
Native Code Set.....	163
Conversion Code Set (CCS) .....	163
Transmission Code Set (TCS).....	163
Code Set Negotiation.....	163
Supported Code Sets.....	163
Deploying client-only applications using Client Run-time .....	163
Usage.....	164

## **Using IDL..... 165**

Introduction to IDL .....	165
How the IDL compiler generates code .....	165
Example IDL specification.....	165
Looking at the generated code .....	165
_<interface_name>Stub.java .....	166
<interface_name>.java .....	166
<interface_name>Helper.java.....	166
<interface_name>Holder.java.....	168
<interface_name>Operations.java .....	168
<interface_name>POA.java.....	169
<interface_name>POATie.java.....	169
Defining interface attributes in IDL .....	170
Specifying one-way methods with no return value.....	170
Specifying an interface in IDL that inherits from another interface.....	171

## **Using the Smart Agent..... 173**

What is the Smart Agent?.....	173
Best practices for Smart Agent configuration and synchronization .....	173
General guidelines .....	174
Load balancing/ fault tolerance guidelines .....	174
Location service guidelines .....	175
When not to use a Smart Agent .....	175
Locating Smart Agents.....	175
Locating objects through Smart Agent cooperation .....	175
Cooperating with the OAD to connect with objects .....	176
Starting a Smart Agent (osagent).....	176
Verbose output.....	177



Disabling the agent.....	177
Ensuring Smart Agent availability.....	177
Checking client existence.....	178
Working within VisiBroker ORB domains.....	178
Connecting Smart Agents on different local networks.....	179
How Smart Agents detect each other.....	180
Working with multihomed hosts.....	180
Specifying interface usage for Smart Agents.....	181
Using point-to-point communications.....	182
Specifying a host as a runtime parameter.....	182
Specifying an IP address with an environment variable.....	182
Specifying hosts with the agentaddr file.....	183
Ensuring object availability.....	183
Invoking methods on stateless objects.....	183
Achieving fault-tolerance for objects that maintain state.....	184
Replicating objects registered with the OAD.....	184
Migrating objects between hosts.....	184
Migrating objects that maintain state.....	184
Migrating instantiated objects.....	185
Migrating objects registered with the OAD.....	185
Reporting all objects and services.....	185
Binding to Objects.....	186

## **Using the Location Service ..... 187**

What is the Location Service?.....	187
Location Service components.....	188
What is the Location Service agent?.....	188
Obtaining addresses of all hosts running Smart Agents.....	189
Finding all accessible interfaces.....	189
Obtaining references to instances of an interface.....	190
Obtaining references to like-named instances of an interface.....	190
What is a trigger?.....	190
Looking at trigger methods.....	191
Creating triggers.....	191
Looking at only the first instance found by a trigger.....	192
Querying an agent.....	192
Finding all instances of an interface.....	192
Finding interfaces and instances known to Smart Agents.....	193
Writing and registering a trigger handler.....	196

## **Using the VisiNaming Service ..... 199**

Overview.....	199
Understanding the namespace.....	200
Naming contexts.....	200
Naming context factories.....	201
Names and NameComponent.....	201
Name resolution.....	202
Stringified names.....	202
Simple and complex names.....	202
Running the VisiNaming Service.....	203
Installing the VisiNaming Service.....	203
Configuring the VisiNaming Service.....	203
Starting the VisiNaming Service.....	203
Starting the VisiNaming Service with the vbj command.....	204
Invoking the VisiNaming Service from the command line.....	204
Configuring nsutil.....	204
Running nsutil.....	205

Shutting down the VisiNaming Service using nsutil .....	205
Bootstrapping the VisiNaming Service .....	206
Calling resolve_initial_references.....	206
Using -DSVCnameroot .....	206
Using -DORBInitRef .....	206
Using a corbaloc URL .....	206
Using a corbaname URL .....	207
-DORBDefaultInitRef.....	207
Using -DORBDefaultInitRef with a corbaloc URL.....	207
Using -DORBDefaultInitRef with corbaname .....	207
NamingContext .....	208
NamingContextExt.....	208
Default naming contexts.....	209
Obtaining the default naming context .....	209
Obtaining naming context factories.....	209
VisiNaming Service properties .....	209
Logging properties .....	212
Pluggable backing store .....	212
Types of backing stores.....	212
In-memory adapter.....	213
JDBC adapter .....	213
DataExpress adapter .....	213
JNDI adapter.....	213
Configuration and use.....	213
Properties file .....	214
JDBC Adapter properties .....	214
DataExpress Adapter properties.....	216
JNDI adapter properties.....	216
Configuration for OpenLDAP .....	217
Caching facility .....	217
Important Notes for users of Caching Facility .....	218
Object Clusters .....	218
Object Clustering criteria .....	219
Cluster and ClusterManager interfaces .....	219
IDL Specification for the Cluster interface.....	220
IDL Specification for the ClusterManager interface.....	220
IDL Specification for the NamingContextExtExtended interface.....	221
Creating an object cluster .....	221
Explicit and implicit object clusters .....	222
Load balancing .....	223
Object failover .....	223
Pruning stale object references in VisiNaming object clusters .....	223
VisiNaming Service Clusters for Failover and Load Balancing .....	224
Configuring the VisiNaming Service Cluster.....	225
Configuring the VisiNaming Service in Master/Slave mode .....	226
Starting up with a large number of connecting clients .....	226
VisiNaming service federation .....	227
VisiNaming Service Security.....	228
Naming client authentication .....	229
Configuring VisiNaming to use SSL .....	229
Method Level Authorization.....	230
Import statements .....	231
Sample programs .....	232
Binding a name example.....	232
Configuring VisiNaming with JDataStore HA .....	234
Create a DB for the Primary mirror .....	234
Invoke JdsServer for each listening connection.....	235

Configure JDataStore HA .....	235
Run the VisiNaming Explicit Clustering example .....	236
Run the VisiNaming Naming Failover example .....	237
<b>Using the Event Service .....</b>	<b>241</b>
Overview .....	241
Proxy consumers and suppliers .....	242
OMG Common Object Services specification .....	242
Communication models .....	243
Push model .....	243
Pull model .....	244
Using event channels .....	245
Creating event channels .....	246
Examples of push supplier and consumer .....	247
Push supplier and consumer example .....	247
Running the Push model example .....	247
Running the PullModel example .....	247
Running the PullView example .....	248
PullSupply .....	248
Executing PullSupply .....	248
Implementation of the pull and try_pull methods .....	248
Main method of PullSupply .....	249
PullConsume .....	250
Executing PullConsume .....	250
Starting the Event Service .....	252
Setting the queue length .....	253
In-process event channel .....	253
Using the in-process Event Channel .....	254
Java EventLibrary class .....	254
Java example .....	254
Import statements .....	255
<b>Using the VisiBroker Server Manager .....</b>	<b>257</b>
Getting Started with the Server Manager .....	257
Enabling the Server Manager on a server .....	257
Obtaining a Server Manager reference .....	257
Working with Containers .....	258
The Storage Interface .....	258
The Container Interface .....	259
Container class .....	259
Container Methods for Java .....	259
Methods related to property manipulation and queries .....	259
Methods related to operations .....	260
Methods related to children containers .....	260
Methods related to storage .....	261
The Storage Interface .....	261
Storage Interface Class and Methods .....	262
Storage Class .....	262
Storage Interface Methods .....	262
Limiting access to the Server Manager .....	263
Server Manager IDL .....	263
Server Manager examples .....	265
Obtaining the reference to the top-level container .....	265
Getting all the containers and their properties .....	265
Getting and setting properties and saving them into the file .....	266
Invoking an operation in a Container .....	267
Custom Containers .....	268

<b>Using VisiBroker Native Messaging</b> .....	<b>269</b>
Introduction .....	269
Two-phase invocation (2PI) .....	269
Polling-Pulling and Callback models .....	269
Non-native messaging and IDL mangling .....	269
Native Messaging solution .....	270
Request Agent .....	270
Native Messaging Current.....	271
Core operations .....	271
StockManager example .....	272
Polling-pulling model .....	272
Callback model .....	274
Advanced Topics.....	277
Group polling.....	277
Cookie and reply de-multiplexing in reply recipients.....	279
Evolving invocations into two-phases .....	280
Reply dropping .....	281
Manual trash collection .....	282
Unsuppressed premature return mode .....	283
Suppress poller generation in callback model .....	284
Native Messaging API Specification .....	284
Interface RequestAgentEx .....	284
create_request_proxy() .....	284
destroy_request() .....	286
Interface RequestProxy .....	286
the_receiver .....	286
poll().....	287
destroy() .....	287
Local interface Current.....	287
suppress_mode() .....	287
wait_timeout .....	288
the_cookie .....	288
request_tag .....	288
the_poller .....	288
reply_not_available .....	289
Interface ReplyRecipient.....	290
reply_available() .....	290
Semantics of core operations .....	290
Native Messaging Interoperability Specification.....	291
Native Messaging uses native GIOP .....	291
Native Messaging service context .....	291
NativeMessaging tagged component .....	293
Using Native Messaging.....	293
Using request agent and client model.....	293
Start the Request Agent.....	293
Request Agent URL .....	293
Using the Native Messaging client model .....	293
Request Agent vbroker properties.....	294
vbroker.requestagent.maxThreads.....	294
vbroker.requestagent.maxOutstandingRequests .....	294
vbroker.requestagent.blockingTimeout .....	294
vbroker.requestagent.router.ior .....	294
vbroker.requestagent.listener.port .....	294
vbroker.requestagent.requestTimeout .....	294
Interoperability with CORBA Messaging .....	294

<b>Using the Object Activation Daemon (OAD)</b> .....	<b>295</b>
Automatic activation of objects and servers .....	295
Locating the Implementation Repository data .....	295
Activating servers .....	295
Using the OAD .....	296
Starting the OAD .....	296
Using the OAD utilities .....	297
Converting interface names to repository IDs .....	297
Listing objects with oadutil list .....	298
Registering objects with oadutil .....	299
Example: Registering a POA .....	300
Example: Specifying repository ID .....	301
Example: Specifying IDL interface name .....	301
Remote registration to an OAD .....	301
Using the OAD without using the Smart Agent .....	302
Using the OAD with the Naming Service .....	302
Distinguishing between multiple instances of an object .....	303
Setting activation properties using the CreationImplDef class .....	303
Dynamically changing an ORB implementation .....	303
OAD Registration using OAD::reg_implementation .....	304
Example of object creation and registration .....	305
Arguments passed by the OAD .....	306
Un-registering objects .....	306
Un-registering objects using the oadutil tool .....	306
Unregistration example .....	307
Unregistering with the OAD operations .....	307
Displaying the contents of the Implementation Repository .....	308
IDL interface to the OAD .....	308
<b>Using Interface Repositories</b> .....	<b>311</b>
What is an Interface Repository? .....	311
What does an Interface Repository contain? .....	311
How many Interface Repositories can you have? .....	312
Creating and viewing an Interface Repository with irep .....	312
Creating an Interface Repository with irep .....	313
Viewing the contents of the Interface Repository .....	313
Updating an Interface Repository with idl2ir .....	314
Understanding the structure of the Interface Repository .....	314
Identifying objects in the Interface Repository .....	315
Types of objects that can be stored in the Interface Repository .....	315
Inherited interfaces .....	316
Accessing an Interface Repository .....	317
Interface Repository example program .....	317
<b>Using the Dynamic Invocation Interface</b> .....	<b>319</b>
What is the dynamic invocation interface? .....	319
Introducing the main DII concepts .....	320
Using request objects .....	320
Encapsulating arguments with the Any type .....	321
Options for sending requests .....	321
Options for receiving replies .....	322
Steps for invoking object operations dynamically .....	322
Example programs for using the DII .....	322
Using the idl2java compiler .....	322
Obtaining a generic object reference .....	322
Creating and initializing a request .....	323
Request interface .....	323

Ways to create and initialize a DII request .....	324
Using the create_request method .....	324
Using the _request method .....	324
Example of creating a Request object.....	325
Setting arguments for the request .....	326
Implementing a list of arguments with the NVList.....	326
Setting input and output arguments with the NamedValue Class.....	326
Passing type safely with the Any class.....	327
Representing argument or attribute types with the TypeCode class.....	327
Sending DII requests and receiving results .....	329
Invoking a request .....	329
Sending a deferred DII request with the send_deferred method .....	329
Sending an asynchronous DII request with the send_oneway method .....	330
Sending multiple requests .....	330
Receiving multiple requests .....	330
Using the interface repository with the DII .....	331

## **Using the Dynamic Skeleton Interface ..... 333**

What is the Dynamic Skeleton Interface?.....	333
Using the idl2java compiler.....	333
Steps for creating object implementations dynamically .....	334
Example program for using the DSI .....	334
Extending the DynamicImplementation class.....	334
Example of designing objects for dynamic requests.....	334
Specifying repository ids .....	336
Looking at the ServerRequest class.....	337
Implementing the Account object .....	337
Implementing the AccountManager object .....	338
Processing input parameters.....	338
Setting the return value .....	339
Server implementation.....	339

## **Using Portable Interceptors..... 341**

Portable Interceptors overview.....	341
Types of interceptors .....	341
Types of Portable Interceptors.....	342
Portable Interceptor and Information interfaces.....	342
Interceptor class .....	342
Request Interceptor.....	342
ClientRequestInterceptor .....	343
Client-side rules.....	344
ServerRequestInterceptor .....	344
Server-side rules .....	345
IOR Interceptor .....	346
Portable Interceptor (PI) Current.....	346
Codec.....	347
CodecFactory.....	347
Creating a Portable Interceptor .....	347
Example: Creating a PortableInterceptor .....	348
Registering Portable Interceptors.....	348
Registering an ORBInitializer.....	349
Example: Registering ORBInitializer.....	350
VisiBroker extensions to Portable Interceptors.....	350
POA scoped Server Request Interceptors.....	350
Inserting and extracting system exceptions .....	351
Limitations of VisiBroker Portable Interceptors implementation.....	351
ClientRequestInfo limitations .....	351

ServerRequestInfo limitations.....	351
Portable Interceptors examples.....	352
Example: client_server .....	352
Objective of example.....	352
Importing required packages.....	352
Client-side request interceptor initialization and registration to the ORB .....	353
Implementing the ORBInitializer for a server-side Interceptor .....	354
Implementing the RequestInterceptor for client- or server-side Interceptor...	355
Implementing the ClientRequestInterceptor for Client .....	355
The void send_request(ClientRequestInfo ri) method.....	355
The void send_poll(ClientRequestInfo ri) method .....	356
The void receive_reply(ClientRequestInfo ri) method.....	356
The void receive_exception(ClientRequestInfo ri) method.....	356
The void receive_other(ClientRequestInfo ri) method.....	356
Implementing the ServerRequestInterceptor for Server.....	358
The void receive_request_service_contexts (ServerRequestInfo ri) method	359
The void receive_request (ServerRequestInfo ri) method .....	359
The void send_reply (ServerRequestInfo ri) method .....	359
The void send_exception (ServerRequestInfo ri) method.....	359
The void send_other (ServerRequestInfo ri) method.....	359
Developing the Client and Server Application.....	362
Implementing the client application.....	362
Implementing the server application .....	364
Compilation procedure.....	365
Execution or deployment of Client and Server Applications .....	365

## **Using VisiBroker Interceptors ..... 367**

Interceptors overview.....	367
Interceptor interfaces and managers .....	368
Client Interceptors .....	368
BindInterceptor .....	368
ClientRequestInterceptor .....	368
Server Interceptors.....	369
POALifeCycleInterceptor .....	369
ActiveObjectLifeCycleInterceptor .....	370
ServerRequestInterceptor .....	370
IORCreationInterceptor .....	371
Service Resolver Interceptor .....	371
Default Interceptor classes.....	371
Registering Interceptors with the VisiBroker ORB .....	371
Creating Interceptor objects.....	372
Loading Interceptors .....	372
Example Interceptors .....	373
Example code.....	373
Client-server Interceptors example .....	373
ServiceResolverInterceptor example.....	374
Code listings .....	376
SampleServerLoader.....	376
SamplePOALifeCycleInterceptor .....	377
SampleServerInterceptor.....	378
SampleClientInterceptor .....	379
SampleClientLoader .....	380
SampleBindInterceptor.....	381
Passing information between your Interceptors .....	382
Using both Portable Interceptors and VisiBroker Interceptors simultaneously .....	382
Order of invocation of interception points.....	382

Client side Interceptors .....	382
Server side Interceptors.....	383
Order of ORB events during POA creation .....	383
Order of ORB events during object reference creation .....	383
<b>Using object wrappers .....</b>	<b>385</b>
Object wrappers overview .....	385
Typed and un-typed object wrappers .....	385
Special idl2java requirements .....	386
Object wrapper example applications .....	386
Untyped object wrappers.....	386
Using multiple, untyped object wrappers .....	387
Order of pre_method invocation .....	387
Order of post_method invocation.....	387
Using untyped object wrappers .....	387
Implementing an untyped object wrapper factory .....	388
Implementing an untyped object wrapper .....	389
pre_method and post_method parameters .....	389
Creating and registering untyped object wrapper factories .....	390
Removing untyped object wrappers .....	392
Typed object wrappers .....	392
Using multiple, typed object wrappers.....	393
Order of invocation.....	394
Typed object wrappers with co-located client and servers .....	394
Using typed object wrappers .....	394
Implementing typed object wrappers .....	395
Registering typed object wrappers for a client .....	395
Registering typed object wrappers for a server .....	396
Removing typed object wrappers.....	398
Combined use of untyped and typed object wrappers .....	398
Command-line arguments for typed wrappers .....	398
Initializer for typed wrappers .....	399
Command-line arguments for untyped wrappers.....	400
Initializers for untyped wrappers .....	400
Executing the sample applications .....	401
Turning on timing and tracing object wrappers .....	402
Turning on caching and security object wrappers .....	402
Turning on typed and untyped wrappers.....	402
Executing a Co-located client and server .....	403
<b>Event Queue .....</b>	<b>405</b>
Event types .....	405
Connection events.....	405
Event listeners .....	405
IDL definition.....	405
ConnInfo structure.....	406
EventListener interface .....	406
ConnEventListeners interface.....	406
EventQueueManager interface .....	406
How to return the EventQueueManager .....	407
Event Queue code samples .....	407
Registering EventListeners .....	407
Implementing EventListeners.....	408
<b>Using RMI over IIOP.....</b>	<b>409</b>
Overview of RMI over IIOP .....	409
Setting up Java applets with RMI-IIOP .....	409



java2iiop and java2idl tools .....	409
Using java2iiop .....	409
Supported interfaces .....	409
Running java2iiop .....	410
Reverse mapping of Java classes to IDL .....	410
Completing the development process .....	411
RMI-IIOP Bank example .....	411
Supported data types .....	413
Mapping primitive data types .....	413
Mapping complex data types .....	413
Interfaces .....	413
Arrays .....	414
<b>Using the dynamically managed types .....</b>	<b>415</b>
DynAny interface overview .....	415
DynAny examples .....	415
DynAny types .....	415
DynAny usage restrictions .....	416
Creating a DynAny .....	416
Initializing and accessing the value in a DynAny .....	416
Constructed data types .....	416
Traversing the components in a constructed data type .....	417
DynEnum .....	417
DynStruct .....	417
DynUnion .....	417
DynSequence and DynArray .....	417
DynAny example IDL .....	418
DynAny example client application .....	418
DynAny example server application .....	420
<b>Using valuetypes .....</b>	<b>425</b>
Understanding valuetypes .....	425
Valuetype IDL code sample .....	425
Concrete valuetypes .....	425
Valuetype derivation .....	425
Sharing semantics .....	425
Null semantics .....	426
Factories .....	426
Abstract valuetypes .....	426
Implementing valuetypes .....	426
Defining your valuetypes .....	426
Compiling your IDL file .....	427
Inheriting the valuetype base class .....	427
Implementing the Factory class .....	427
Registering your Factory with the VisiBroker ORB .....	428
Implementing factories .....	428
Factories and valuetypes .....	429
Registering valuetypes .....	429
Boxed valuetypes .....	429
Abstract interfaces .....	429
Custom valuetypes .....	430
Truncatable valuetypes .....	431
<b>Using URL naming .....</b>	<b>433</b>
URL Naming Service .....	433
URL Naming Service examples .....	433
Registering objects .....	434

Locating an object by URL .....	435
<b>Bidirectional Communication .....</b>	<b>437</b>
Using bidirectional IIOP .....	437
Bidirectional VisiBroker ORB properties.....	437
About the BiDirectional examples .....	438
Enabling bidirectional IIOP for existing applications .....	439
Explicitly enabling bidirectional IIOP.....	439
Unidirectional or bidirectional connections .....	440
Enabling bidirectional IIOP for POAs.....	440
Security considerations .....	441
<b>Using the BOA with VisiBroker.....</b>	<b>443</b>
Compiling your BOA code with VisiBroker.....	443
Supporting BOA options .....	443
Limitations in using the BOA .....	443
Using object activators.....	443
Naming objects under the BOA.....	444
Object names .....	444
<b>Using object activators .....</b>	<b>445</b>
Deferring object activation.....	445
Activator interface .....	445
Using the service activation approach.....	446
Deferring object activation using service activators .....	446
Example of deferred object activation for a service .....	447
odb.idl interface.....	447
Implementing a service activator .....	448
Instantiating the service activator .....	449
Using a service activator to activate an object.....	449
<b>CORBA exceptions .....</b>	<b>451</b>
CORBA exception descriptions .....	451
Heuristic OMG-specified exceptions.....	456
Other OMG-specified exceptions .....	457
<b>Web Services Overview .....</b>	<b>459</b>
Web Services Architecture .....	459
VisiBroker Web Services Architecture .....	460
Web Services Artifacts .....	461
Web Services Runtime .....	461
Exposing a CORBA object as Web Service .....	463
Development .....	464
Deployment.....	465
SOAP/WSDL compatibility.....	466
<b>Index .....</b>	<b>467</b>

# Introduction to VisiBroker

VisiBroker is a set of services and tools that enable you to build, deploy, and manage distributed enterprise applications in your corporate environment.

## Accessing VisiBroker online help topics in the standalone Help Viewer

To access the online help through the standalone Help Viewer on a machine where the product is installed, use one of the following methods:

### Windows

- Choose Start|Programs|Borland VisiBroker|Help Topics
- or, open the Command Prompt and go to the product installation `\bin` directory, then type the following command:

```
help
```

### UNIX

Open a command shell and go to the product installation `/bin` directory, then enter the command:

```
help
```

### Tip

During installation on UNIX systems, the default is to not include an entry for `bin` in your `PATH`. If you did not choose the custom install option and modify the default for `PATH` entry, and you do not have an entry for current directory in your `PATH`, use `./help` to start the help viewer.

## Accessing VisiBroker online help topics from within a VisiBroker GUI tool

To access the online help from within a VisiBroker GUI tool, choose Help > Help Topics.

The Help menu also contains shortcuts to specific documents within the online help. When you select one of these shortcuts, the Help Topics viewer is launched and the item selected from the Help menu is displayed.

## Documentation conventions

The documentation for VisiBroker uses the typefaces and symbols described below to indicate special text:

Convention	Used for
<i>italics</i>	Used for new terms and book titles.
<code>computer</code>	Information that the user or application provides, sample command lines and code.
<b>bold computer</b>	In text, bold indicates information the user types in. In code samples, bold highlights important statements.

Convention	Used for
[ ]	Optional items.
...	Previous argument that can be repeated.
>	Two mutually exclusive choices.

---

## Platform conventions

The VisiBroker documentation uses the following symbols to indicate platform-specific information:

**Windows:** All supported Windows platforms.

**UNIX:** UNIX platforms

**Solaris:** Solaris only

**Linux:** Linux only

## Contacting Micro Focus

Our Web site gives up-to-date details of contact numbers and addresses.

### Further Information and Product Support

Additional technical information or advice is available from several sources.

The product support pages contain a considerable amount of additional information, such as:

- The WebSync service, where you can download fixes and documentation updates.
- The Knowledge Base, a large collection of product tips and workarounds.
- Examples and Utilities, including demos and additional product documentation.

To connect, enter <http://www.microfocus.com> in your browser to go to the Micro Focus home page.

#### Note:

Some information may be available only to customers who have maintenance agreements.

If you obtained this product directly from Micro Focus, contact us as described on the Micro Focus Web site, <http://www.microfocus.com>. If you obtained the product from another source, such as an authorized distributor, contact them for help first. If they are unable to help, contact us.

### Information We Need

However you contact us, please try to include the information below, if you have it. The more information you can give, the better Micro Focus SupportLine can help you. But if you don't know all the answers, or you think some are irrelevant to your problem, please give whatever information you have.

- The name and version number of all products that you think might be causing a problem.

- Your computer make and model.
- Your operating system version number and details of any networking software you are using.
- The amount of memory in your computer.
- The relevant page reference or section in the documentation.
- Your serial number. To find out these numbers, look in the subject line and body of your Electronic Product Delivery Notice email that you received from Micro Focus.

## Contact information

Our Web site gives up-to-date details of contact numbers and addresses. Additional technical information or advice is available from several sources.

The product support pages contain considerable additional information, including the WebSync service, where you can download fixes and documentation updates. To connect, enter <http://www.microfocus.com> in your browser to go to the Micro Focus home page.

If you are a Micro Focus SupportLine customer, please see your SupportLine Handbook for contact information. You can download it from our Web site or order it in printed form from your sales representative. Support from Micro Focus may be available only to customers who have maintenance agreements.

You may want to check these URLs in particular:

- <https://www.microfocus.com/product-trials/corba/index.aspx?productname=VisiBroker> (VisiBroker trial software)
- <http://supportline.microfocus.com/xmlloader.asp?type=home&redirectpage=temporary.asp?aspneturl=/websync/productupdatessearch.aspx> (updated VisiBroker files and other software)
- <https://supportline.microfocus.com/productdoc.aspx> (documentation updates and PDFs)

To subscribe to Micro Focus electronic newsletters, use the online form at:

<http://www.microfocus.com/Resources/Newsletters/infocus/newsletter-subscription.asp>



# Understanding the CORBA model

This section introduces VisiBroker, which comprises both the VisiBroker for C++ and the VisiBroker for Java ORBs. Both are implementations of the CORBA 3.0 specification. This section describes VisiBroker features and components.

## What is CORBA?

The Common Object Request Broker Architecture (CORBA) allows distributed applications to interoperate (application-to-application communication), regardless of what language they are written in or where these applications reside.

The CORBA specification was adopted by the Object Management Group to address the complexity and high cost of developing distributed object applications. CORBA uses an object-oriented approach for creating software components that can be reused and shared between applications. Each object encapsulates the details of its inner workings by presenting a well-defined interface. Use of these interfaces, themselves written in the standardized Interface Definition Language (IDL) reduces application complexity. The cost of developing applications is reduced, because once an object is implemented and tested, it can be used over and over again.

The role of the Object Request Broker (ORB) is to track and maintain these interfaces, facilitate communication between them, and provide services to applications making use of them. The ORB itself is not a separate process. It is a collection of libraries and network resources that integrates within end-user applications, and allows your client applications to locate and use disparate objects.

The Object Request Broker in the following figure connects a client application with the objects it wants to use. The client program does not need to know whether the object it seeks resides on the same computer or is located on a remote computer somewhere on the network. The client program only needs to know the object's name and understand how to use the object's interface. The ORB takes care of the details of locating the object, routing the request, and returning the result.

**Figure 1** Client program acting on an object

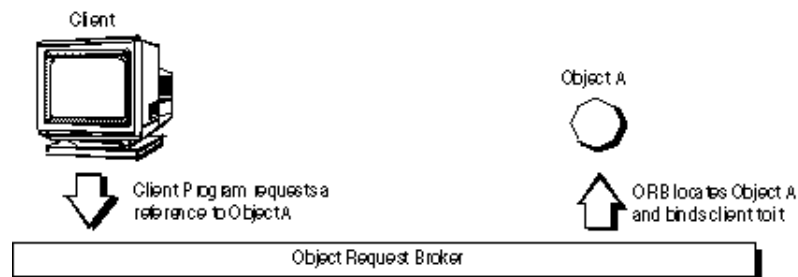

## What is VisiBroker?

VisiBroker provides a complete CORBA 3.0 ORB run-time and supporting development environment for building, deploying, and managing distributed applications for both C++ and Java that are open, flexible, and interoperable. Objects built with VisiBroker are easily accessed by Web-based applications that communicate using the Internet Inter-ORB Protocol (IIOP) standard for communication between distributed objects through the Internet or through local intranets. VisiBroker has a built-in implementation of IIOP that ensures high-performance and interoperability.

Figure 2 VisiBroker Architecture

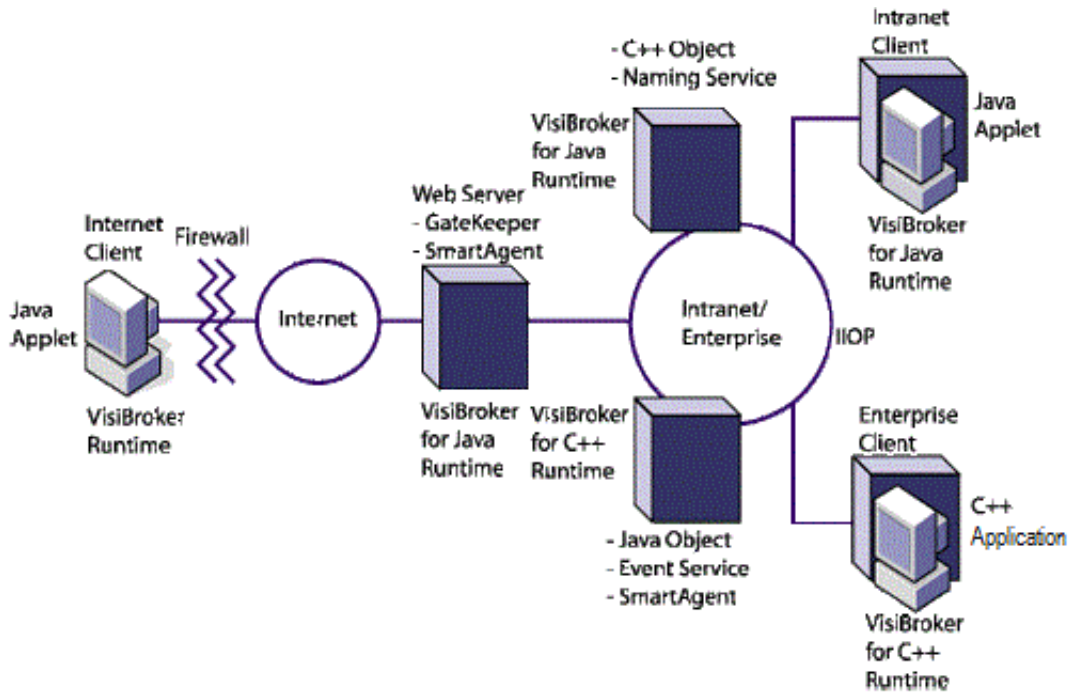

## VisiBroker Features

VisiBroker has several key features as described in the following sections.

### VisiBroker's Smart Agent (osagent) Architecture

VisiBroker's Smart Agent (osagent) is a dynamic, distributed directory service that provides naming facilities for both client applications and object implementations. Multiple Smart Agents on a network cooperate to provide load-balancing and high availability for client access to server objects. The Smart Agent keeps track of objects that are available on a network, and locates objects for client applications at object-invocation time. VisiBroker can determine if the connection between your client application and a server object has been lost (due to an error such as a server crash or a network failure). When a failure is detected, an attempt is automatically made to connect your client to another server on a different host, if it is so configured. For details on the Smart Agent see ["Using the Smart Agent"](#) and ["Using Quality of Service \(QoS\)"](#).



## Enhanced Object Discovery Using the Location Service

VisiBroker provides a powerful Location Service—an extension to the CORBA specification—that enables you to access the information from multiple Smart Agents. Working with the Smart Agents on a network, the Location Service can see all the available instances of an object to which a client can bind. Using *triggers*, a callback mechanism, client applications can be instantly notified of changes to an object's availability. Used in combination with *interceptors*, the Location Service is useful for developing enhanced load balancing of client requests to server objects. See [“Using the Location Service”](#).

## Implementation and Object Activation Support

The Object Activation Daemon (OAD) is the VisiBroker implementation of the Implementation Repository. The OAD can be used to automatically start object implementations when clients need to use them. Additionally, VisiBroker provides functionality that enables you to defer object activation until a client request is received. You can defer activation for a particular object or an entire class of objects on a server.

## Robust thread and connection management

VisiBroker provides native support for single- and multi-threaded thread management. With VisiBroker's thread-per-session model, threads are automatically allocated on the server (per client connection) to service multiple requests, and then are terminated when each connection ends. With the thread pooling model, threads are allocated based on the amount of request traffic to and from server objects. This means that a highly active client will be serviced by multiple threads—ensuring that the requests are quickly executed—while less active clients can share a single thread and still have their requests immediately serviced.

VisiBroker's connection management minimizes the number of client connections to the server. All client requests for objects residing on the same server are multiplexed over the same connection, even if they originate from different threads. Additionally, released client connections are recycled for subsequent reconnects to the same server, eliminating the need for clients to incur the overhead of new connections to the same server.

All thread and connection behavior is fully configurable. See [“Managing threads and connections”](#) for details on how VisiBroker manages threads and connections.

## IDL compilers

VisiBroker comes with three IDL compilers that make object development easier:

- `idl2java`: The `idl2java` compiler takes IDL files as input and produces the necessary client stubs and server skeletons in Java.
- `idl2cpp`: The `idl2cpp` compiler takes IDL files as input and produces the necessary client stubs and server skeletons in C++.

- `idl2ir`: The `idl2ir` compiler takes an IDL file and populates an interface repository with its contents. Unlike the previous two compilers, `idl2ir` functions with both the C++ and Java ORBs.

See [“Using IDL”](#) and [“Using Interface Repositories”](#) for details on these compilers.

## Dynamic invocation with DII and DSI

VisiBroker provides implementations of both the Dynamic Invocation Interface (DII) and the Dynamic Skeleton Interface (DSI) for dynamic invocation. The DII allows client applications to dynamically create requests for objects that were not defined at compile time. The DSI allows servers to dispatch client operation requests to objects that were not defined at compile time. See [“Using the Dynamic Invocation Interface”](#) and [“Using the Dynamic Skeleton Interface”](#) for more information.

## Interface and implementation repositories

The Interface Repository (IR) is an online database of meta information about the VisiBroker ORB objects. Meta information stored for objects includes information about modules, interfaces, operations, attributes, and exceptions. [“Using Interface Repositories”](#) covers how to start an instance of the Interface Repository, add information to an interface repository from an IDL file, and extract information from an interface repository.

The Object Activation Daemon is a VisiBroker interface to the Implementation Repository that is used to automatically activate the implementation when a client references the object. See [“Using the Object Activation Daemon \(OAD\)”](#) for more information.

## Server-side portability

VisiBroker supports the CORBA Portable Object Adapter (POA), which is a replacement for the Basic Object Adapter (BOA). The POA shares some of the functionality of the BOA, such as activating objects, support for transient or persistent objects, and so forth. The POA also has additional functionality, such as POA Manager and Servant Manager, which create and manage instances of your objects. See [“Using POAs”](#) for more information.

## Customizing the VisiBroker ORB with interceptors and object wrappers

VisiBroker's Interceptors enable developers to view under-the-cover communications between clients and servers. The VisiBroker Interceptors are Micro Focus's proprietary interceptors. Interceptors can be used to extend the VisiBroker ORB with customized client and server code that enables load balancing, monitoring, or security to meet the specialized needs of distributed applications. See [“Using Portable Interceptors”](#) for information.

VisiBroker also includes the Portable Interceptors, based on the OMG standardized feature, that allow you to write portable code for interceptors and use it with different vendor ORBs. For more information, refer to the *CORBA 3.0 specification*.

VisiBroker's object wrappers allow you to define methods that are called when a client application invokes a method on a bound object or when a

server application receives an operation request. See “[Using object wrappers](#)” for information.

## Event Queue

The event queue is designed as a server-side only feature. A server can register the listeners to the event queue based on the event types that the server is interested in, and the server processes those events when the need arises. See “[Event Queue](#)” for more information.

## Backing stores in the Naming Service

The new interoperable Naming Service integrates with pluggable backing stores to make its state persistent. This ensures easy fault tolerance and failover functionality in the Naming Service. See “[Using the VisiNaming Service](#)” for more information.

## Defining interfaces without IDL

VisiBroker's `java2iiop` compiler lets you use the Java language to define interfaces instead of using the Interface Definition Language (IDL). You can use the `java2iiop` compiler if you have existing Java code that you wish to adapt to interoperate with CORBA distributed objects or if you do not wish to learn IDL.

## GateKeeper

The GateKeeper allows client programs to issue operation requests to objects that reside on a web server and to receive callbacks from those objects, all the while conforming to the security restrictions imposed by web browsers. The Gatekeeper also handles communication through firewalls and can be used as an HTTP daemon. It is fully compliant with the OMG CORBA Firewall Specification. For more information see the *VisiBroker GateKeeper Guide*.

## VisiBroker CORBA compliance

VisiBroker 8.5 is compliant with version 3.0 of the CORBA specification from the OMG. All changes between the earlier version 2.6 and version 3.0 are implemented. Note that VisiBroker:

- Supports General Inter-ORB Protocol (GIOP) to standard 1.2; GIOP 1.3-related features are not implemented.
- Does not support the CORBA Component Model (CCM) or Fixed types.

For more details, refer to the CORBA specification located at <http://www.omg.org/>.

## VisiBroker Development Environment

VisiBroker can be used in both the development and deployment phases. The development environment includes the following components:

- Administration and programming tools
- VisiBroker ORB

## Programmer's tools

The following tools are used during the development phase:

Tool	Purpose
idl2ir	Enables you to populate an interface repository with interfaces defined in an IDL file for both the VisiBroker for Java and VisiBroker for C++.
idl2cpp	Generates C++ stubs and skeletons from an IDL file.
idl2java	Generates Java stubs and skeletons from an IDL file
java2iiop	Generates Java stubs and skeletons from a Java file. This allows you to define your interfaces in Java, rather than in IDL.
java2idl	Generates an IDL file from a file containing Java bytecode.

## CORBA services tools

The following tools are used to administer CORBA services during development:

Tool	Purpose
irep	Used to manage the Interface Repository. See <a href="#">“Using Interface Repositories”</a> .
oad	Used to manage the Object Activation Daemon (OAD). See <a href="#">“Using the Object Activation Daemon (OAD)”</a> .
nameserv	Used to start an instance of the Naming Service. See <a href="#">“Using the VisiNaming Service”</a> .

## Administration Tools

The following tools are used to administer the VisiBroker ORB during development:

Tool	Purpose
oadutil list	Lists VisiBroker ORB object implementations registered with the OAD.
oadutil reg	Registers a VisiBroker ORB object implementation with the OAD.
oadutil unreg	Unregisters a VisiBroker ORB object implementation with the OAD.
osagent	Manages the Smart Agent. See <a href="#">“Using the Smart Agent”</a> .
osfind	Reports on objects running on a given network.

# Java Development Environment

VisiBroker uses the following components in the Java run-time environment:

- Java 2 Standard Edition
- Java run-time environment

## Java 2 Standard Edition

A Java development environment, such as JBuilder, is required for developing applets or applications that use the VisiBroker ORB. Oracle's Java Developer's Kit (JDK) also includes a Java runtime environment.

The JDK—including its Java runtime environment—is available for Solaris and Windows platforms. You can download the JDK from Oracle's web site:

<http://www.oracle.com/technetwork/indexes/downloads/index.html>

The JDK has also been ported to IBM AIX, OS/2, SGI IRIX, and HP-UX. These other versions can be downloaded from the respective hardware vendor's web site. To see what is available for various platforms, see:

<http://www.oracle.com/us/products/index.html>

## Java Run-time Environment

A Java run-time environment is required for any end user who wishes to execute VisiBroker services and tools. A Java runtime environment is an engine that interprets and executes a Java application. Typically, Java runtime environments are bundled with Java development environments. See “[Java 2 Standard Edition](#)” for details.

## What's Required for GateKeeper

In order to use the VisiBroker Gatekeeper, you will need to use the Servlet 2.1 API that is included in JavaServer Web Development Kit 1.0.1.

## Java-enabled Web browser

Applets can be run in any Java-enabled web browser. You may require a Java plug-in for the browser; see the browser manufacturer's website for details.

# Interoperability with VisiBroker

Applications created with VisiBroker for Java can communicate with object implementations developed with VisiBroker for C++. Likewise, for applications created with VisiBroker for C++, these applications can also communicate with objects implementations developed with VisiBroker for Java. For example, if you want to use Java application on VisiBroker for C++, simply use the same IDL you used to develop your Java application as input to the VisiBroker IDL compiler, supplied with VisiBroker for C++. You may then use the resulting C++ skeletons to develop the object implementation. To use the C++ application on VisiBroker for Java, repeat the process. However, you will use the VisiBroker IDL compiler with VisiBroker for Java instead.

Also, object implementations written with VisiBroker for Java will work with clients written in VisiBroker for C++. In fact, a server written with VisiBroker for Java will work with *any* CORBA-compliant client; a client written with VisiBroker for Java will work with *any* CORBA-compliant server. This also applies to any VisiBroker for C++ object implementations.

# Interoperability with other ORB products

CORBA-compliant software objects communicate using the Internet Inter-ORB Protocol (IIOP) and are fully interoperable, even when they are developed by different vendors who have no knowledge of each other's implementations. VisiBroker's use of IIOP allows client and server applications you develop with VisiBroker to interoperate with a variety of ORB products from other vendors.

## IDL to Java mapping

VisiBroker conforms with the *OMG IDL/Java Language Mapping Specification*. See the *VisiBroker Programmer's Reference* for a summary of VisiBroker's current IDL to Java language mapping, as implemented by the `idl2java` compiler. For each IDL construct there is a section that describes the corresponding Java construct, along with code samples.

For more information about the mapping specification, refer to the *OMG IDL/Java Language Mapping Specification*.

# Developing an example application with VisiBroker

This section uses an example application to describe the development process for creating distributed, object-based applications for Java.

The code for the example application is provided in the `bank_agent_java.html` file. You can find this file in:

```
<install_dir>/examples/vbroker/basic/bank_agent/
```

## Development process

When you develop distributed applications with VisiBroker, you must first identify the objects required by the application. The following figure illustrates the steps to develop a sample bank application. Here is a summary of the steps taken to develop the bank sample:

- 1 Write a specification for each object using the Interface Definition Language (IDL).

IDL is the language that an implementer uses to specify the operations that an object will provide and how they should be invoked. In this example, we define, in IDL, the `Account` interface with a `balance()` method and the `AccountManager` interface with an `open()` method.

- 2 Use the IDL compilers to generate the client stub code and server POA servant code.

With the interface specification described in step 1, use the `idl2java` or `idl2cpp` compilers to generate the client-side stubs and the server-side classes for the implementation of the remote objects.

- 3 Write the client program code.

To complete the implementation of the client program, initialize the VisiBroker ORB, bind to the `Account` and the `AccountManager` objects, invoke the methods on these objects, and print out the balance.

- 4 Write the server object code.

To complete the implementation of the server object code, we must derive from the `AccountPOA` and `AccountManagerPOA` classes, provide implementations of the interfaces' methods, and implement the server's `main` routine.

- 5 Compile the client and server code using the appropriate stubs and skeletons.
- 6 Start the server.
- 7 Run the client program.

**Figure 3** Developing the sample bank application

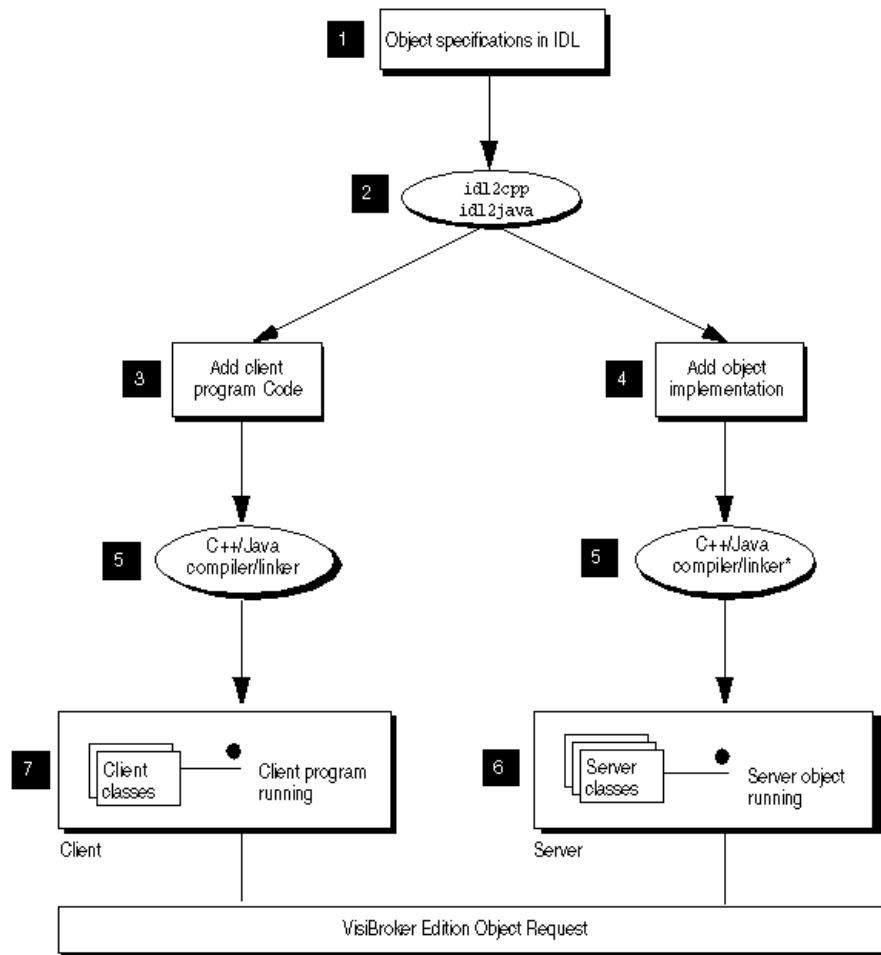

\* C++: If you are creating the application in C++, you will need to compile and link the server object code.

## Step 1: Defining object interfaces

The first step to creating an application with VisiBroker is to specify all of your objects and their interfaces using the OMG's Interface Definition Language (IDL). The IDL can be mapped to a variety of programming languages.

You then use the `idl2java` compiler to generate stub routines and servant code compliant with the IDL specification. The stub routines are used by your client program to invoke operations on an object. You use the servant code, along with code you write, to create a server that implements the object.

### Writing the account interface in IDL

IDL has a syntax similar to Java and can be used to define modules, interfaces, data structures, and more.

The sample below shows the contents of the `Bank.idl` file for the `bank_agent` example. The `Account` interface provides a single method for



obtaining the current balance. The `AccountManager` interface creates an account for the user if one does not already exist.

```
module Bank{
    interface Account {
        float balance();
    };
    interface AccountManager {
        Account open(in string name);
    };
};
```

## Step 2: Generating client stubs and server servants

The interface specification you create in IDL is used by VisiBroker's `idl2java` compiler to generate Java classes for the client program, and skeleton code for the object implementation.

The client program uses the Java class for all method invocations.

You use the skeleton code, along with code you write, to create the server that implements the objects.

The code for the client program and server object, once completed, is used as input to your Java compiler to produce the client and server executable classes.

Because the `Bank.idl` file requires no special handling, you can compile the file with the following command.

```
prompt> idl2java Bank.idl
```

For more information on the command-line options for the `idl2java` compiler, see [“Using IDL”](#).

### Files produced by the idl compiler

Because Java allows only one public interface or class per file, compiling the IDL file will generate several `.java` files. These files are stored in a generated sub-directory called `Bank`, which is the module name specified in the IDL and is the package to which the generated files belong. The following is a list of `.java` files generated:

- `_AccountManagerStub.java`: Stub code for the `AccountManager` object on the client side.
- `_AccountStub.java`: Stub code for the `Account` object on the client side.
- `Account.java`: The `Account` interface declaration.
- `AccountHelper.java`: Declares the `AccountHelper` class, which defines helpful utility methods.
- `AccountHolder.java`: Declares the `AccountHolder` class, which provides a holder for passing `Account` objects.
- `AccountManager.java`: The `AccountManager` interface declaration.
- `AccountManagerHelper.java`: Declares the `AccountManagerHelper` class, which defines helpful utility methods.
- `AccountManagerHolder.java`: Declares the `AccountManagerHolder` class, which provides a holder for passing `AccountManager` objects.

- `AccountManagerOperation.java`: This interface provides the method signatures defined in the `AccountManager` interface in `Bank.idl`.
- `AccountManagerPOA.java`: POA servant code (implementation base code) for the `AccountManager` object implementation on the server side.
- `AccountManagerPOATie.java`: Class used to implement the `AccountManager` object on the server side using the tie mechanism, described in [“Using the tie mechanism”](#).
- `AccountOperations.java`: This interface provides the method signatures defined in the `Account` interface in the `Bank.idl` file
- `AccountPOA.java`: POA servant code (implementation base code) for the `Account` object implementation on the server side.
- `AccountPOATie.java`: Class used to implement the `Account` object on the server side using the tie mechanism, described in [“Using the tie mechanism”](#).

## Step 3: Implementing the client

### Client.java

Many of the classes used in implementing the bank client are contained in the `Bank` package generated by the `idl2java` compiler as shown in the previous example.

The `Client.java` file illustrates this example and is included in the `bank_agent` directory. Normally, you would create this file.

The `Client` class implements the client application which obtains the current balance of a bank account. The bank client program performs these steps:

- 1 Initializes the `VisiBroker` ORB.
- 2 Binds to an `AccountManager` object.
- 3 Obtains an `Account` object by invoking `open` on the `AccountManager` object.
- 4 Obtains the balance by invoking `balance` on the `Account` object.

```
public class Client {
    public static void main(String[] args) {
        // Initialize the ORB.
        org.omg.CORBA.ORB orb = org.omg.CORBA.ORB.init(args,null);
        // Get the manager Id
        byte[] managerId = "BankManager".getBytes();
        // Locate an account manager. Give the full POA name and servant ID.
        Bank.AccountManager manager =
            Bank.AccountManagerHelper.bind(orb, "/bank_agent_poa", managerId);
        // use args[0] as the account name, or a default.
        String name = args.length > 0 ? args[0] : "Jack B. Quick";
        // Request the account manager to open a named account.
        Bank.Account account = manager.open(name);
        // Get the balance of the account.
        float balance = account.balance();
        // Print out the balance.
        System.out.println("The balance in " + name + "'s account is $" +
            balance);
    }
}
```

## Binding to the AccountManager object

Before your client program can invoke the `open(String name)` method, the client must use the `bind()` method to establish a connection to the server that implements the `AccountManager` object.

The implementation of the `bind()` method is generated automatically by the `idl2java` compiler. The `bind()` method requests the `VisiBroker` ORB to locate and establish a connection to the server.

If the server is successfully located and a connection is established, a proxy object is created to represent the server's `AccountManagerPOA` object. An object reference to the `AccountManager` object is returned to your client program.

## Obtaining an Account object

Next, your client class needs to call the `open()` method on the `AccountManager` object to get an object reference to the `Account` object for the specified customer name.

## Obtaining the balance

Once your client program has established a connection with an `Account` object, the `balance()` method can be used to obtain the balance. The `balance()` method on the client side is actually a stub generated by the `idl2java` compiler that gathers all the data required for the request and sends it to the server object.

## AccountManagerHelper.java

This file is located in the `Bank` package. It contains an `AccountManagerHelper` object and defines several methods for binding to the server that implements this object. The `bind()` class method contacts the specified POA manager to resolve the object. Our example application uses the version of the `bind` method that accepts an object name, but the client may optionally specify a particular host and special bind options. For more information about Helper classes, see the *VisiBroker Programmer's Reference*.

```
package Bank;
public final class AccountManagerHelper {
    ...
    public static Bank.AccountManager
    bind(org.omg.CORBA.ORB orb) {
        return bind(orb, null, null, null);
        ...
    }
}
```

## Other methods

Several other methods are provided that allow your client program to manipulate an `AccountManager` object reference.

Many of these methods and member functions are not used in the example client application, but they are described in detail in the *VisiBroker Programmer's Reference*.

## Step 4: Implementing the server

Just as with the client, many of the classes used in implementing the bank server are contained in the Bank package generated by the `idl2java` compiler. The `Server.java` file is a server implementation included for the purposes of illustrating this example. Normally you, the programmer, would create this file.

### Server programs

This file implements the `Server` class for the server side of our banking example. The code sample below is an example of server side programming for Java. The server program does the following:

- Initializes the Object Request Broker.
- Creates a Portable Object Adapter with the required policies.
- Creates the account manager servant object.
- Activates the servant object.
- Activates the POA manager (and the POA).
- Waits for incoming requests.

```
public class Server {
    public static void main(String[] args) {
        try {
            // Initialize the ORB.
            org.omg.CORBA.ORB orb = org.omg.CORBA.ORB.init(args,null);
            // get a reference to the root POA
            POA rootPoa =
                POAHelper.narrow(orb.resolve_initial_references("RootPOA"));
            // Create policies for our persistent POA
            org.omg.CORBA.Policy[] policies = {
                rootPoa.create_lifespan_policy(LifespanPolicyValue.PERSISTENT)
            };
            // Create myPOA with the right policies
            POA myPOA = rootPoa.create_POA( "bank_agent_poa",
                rootPoa.the_POAManager(),
                policies );
            // Create the servant
            AccountManagerImpl managerServant = new AccountManagerImpl();
            // Decide on the ID for the servant
            byte[] managerId = "BankManager".getBytes();
            // Activate the servant with the ID on myPOA
            myPOA.activate_object_with_id(managerId, managerServant);
            // Activate the POA manager
            rootPoa.the_POAManager().activate();
            System.out.println(myPOA.servant_to_reference(managerServant) +
                " is ready.");
            // Wait for incoming requests
            orb.run();
        } catch (Exception e) {
            e.printStackTrace();
        }
    }
}
```

## Step 5: Building the example

The `examples` directory of your VisiBroker release contains a `vbmake.bat` for this example and other VisiBroker examples.

### Compiling the example

#### Windows

Assuming VisiBroker is installed in `C:\vbroker`, type the following to compile the example:

```
prompt> vbmake
```

The command `vbmake` is a batch file which runs the `id12java` compiler and then compiles each file.

If you encounter problems while running `vbmake`, check that your path environment variable points to the `bin` directory where you installed the VisiBroker software.

#### UNIX

Assuming VisiBroker is installed in `/usr/local`, type the following to compile the example:

```
prompt> make java
```

In this example, `make` is the standard UNIX facility. If you do not have it in your `PATH`, see your system administrator.

## Step 6: Starting the server and running the example

Now that you have compiled your client program and server implementation, you are ready to run your first VisiBroker application.

### Starting the Smart Agent

Before you attempt to run VisiBroker client programs or server implementations, you must start the Smart Agent on at least one host in your local network.

The basic command for starting the Smart Agent is:

```
prompt> osagent
```

The Smart Agent is described in detail in [“Using the Smart Agent”](#).

### Starting the server

#### Windows

Open a DOS prompt window and start your server by typing:

```
prompt> start vbj Server
```

#### UNIX

Start your Account server by typing:

```
prompt> vbj Server&
```

## Running the client

### Windows

Open a separate DOS prompt window and start your client by typing:

```
prompt> vbj Client
```

### UNIX

To start your client program, type:

```
prompt> vbj Client
```

You should see output similar to that shown below (the account balance is computed randomly).

```
The balance in the account in $168.38.
```

## Deploying applications with VisiBroker

VisiBroker is also used in the deployment phase. This phase occurs when a developer has created client programs or server applications that have been tested and are ready for production. At this point a system administrator is ready to deploy the client programs on end-users' desktops or server applications on server-class machines.

For deployment, the VisiBroker ORB supports client programs on the front end. You must install the VisiBroker ORB on each machine that runs the client program. Clients (that make use of the VisiBroker ORB) on the same host share the VisiBroker ORB. The VisiBroker ORB also supports server applications on the middle tier. You must install the full VisiBroker ORB on each machine that runs the server application. Server applications or objects (that make use of the VisiBroker ORB) on the same server machine share the VisiBroker ORB. Clients may be GUI front ends, applets, or client programs. Server implementations contain the business logic on the middle tier.

**Figure 4** Client and server programs deployed with VisiBroker ORBs

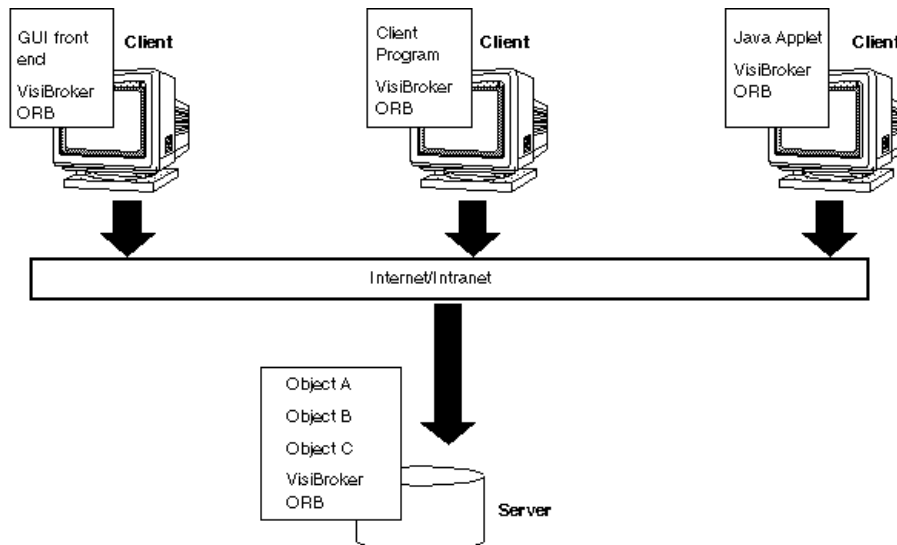

## VisiBroker Applications

### Deploying applications

In order to deploy applications developed with VisiBroker, you must first set up a runtime environment on the host where the application is to be executed and ensure that the necessary support services are available on the local network.

The run-time environment required for applications developed with the Java includes these components:

- Java Runtime Environment.
- VisiBroker Java packages archived in the `vbjorb.jar` file, located in the `lib` subdirectory where you installed VisiBroker.
- Availability of the support services required by the application.

A Java Runtime Environment must be installed on the host where the deployed application is to execute, and the VisiBroker packages must be installed on the host where the deployed application is to execute.

### Environment variables

When you use the `vbj` executable, the environmental variables are automatically set up for you.

If the deployed application is to use a Smart Agent (`osagent`) on a particular host, you must set the `OSAGENT_ADDR` environment variable before running the application. You can use the `vbroker.agent.addr` property as a command-line argument to specify a hostname or IP address. The table below lists the necessary command-line arguments.

If the deployed application is to use a particular UDP port when communicating with a Smart Agent, you must set the `OSAGENT_PORT` environment variable before running the application.

You can use `vbroker.agent.port` (Java) command-line argument to specify the UDP port number.

For more information about environment variables, see the *VisiBroker Installation Guide*.

### Support service availability

A Smart Agent must be executing somewhere on the network where the deployed application is to be executed. Depending on the requirements of the application being deployed, you may need to ensure that other VisiBroker runtime support services are available, as well. These services include:

Support services	Needed when:
Object Activation Daemon ( <code>oad</code> )	A deployed application is a server that implements an object which needs to be started on demand.
Interface Repository ( <code>irep</code> )	A deployed application uses either the dynamic skeleton interface or dynamic implementation interface. See <a href="#">"Using Interface Repositories"</a> for a description of these interfaces.
GateKeeper	A deployed application needs to execute in an environment that uses firewalls for network security.

## Using vbj

You can use the `vbj` command to start your application and enter command-line arguments that control the behavior of your application.

```
vbj -Dvbroker.agent.port=10000 <class>
```

## Running the application

Before you attempt to run VisiBroker client programs or server implementations, you must start the Smart Agent on at least one host in your local network. The Smart Agent is described in detail in [“Starting the Smart Agent”](#).

## Executing client applications

A client application is one that uses VisiBroker ORB objects, but does not offer any VisiBroker ORB objects of its own to other client applications.

A client may be started with the `vbj` command, or from within a Java-enabled web browser.

The following table summarizes the command-line arguments that may be specified for a Java client application.

Options	Description
<code>-DORBagentAddr=&lt;hostname   ip_address&gt;</code>	Specifies the hostname or IP address of the host running the Smart Agent this client should use. If a Smart Agent is not found at the specified address or if this option is not specified, broadcast messages will be used to locate a Smart Agent.
<code>-DORBagentPort=&lt;port_number&gt;</code>	Specifies the port number of the Smart Agent. This option is useful if multiple ORB domains are required. If the port number is not specified, the default value is set to 14000.
<code>-DORBmbufSize=&lt;buffer_size&gt;</code>	Specifies the size of the intermediate buffer used by VisiBroker for operation request processing. To improve performance, the VisiBroker ORB does more complex buffer management than in previous versions of VisiBroker. The default size of send and receive buffers is 4—4kb. If data sent or received is larger than the default, new buffers will be allocated for each request/reply. If your application frequently sends data larger than 4kb and you wish to take advantage of buffer management, you may use this system property to specify a larger number of bytes for a default buffer size.
<code>-DORBtcpNoDelay=&lt;false   true&gt;</code>	When set to <code>true</code> , all network connections will send data immediately. The default is <code>false</code> , which allows a network connection to send data in batches, as the buffer fills.
<code>-DORBconnectionMax=&lt;integer&gt;</code>	Specifies the maximum number of connections allowed for an object implementation when <code>OAid TSession</code> is selected. If you do not specify a value, the default is unlimited.
<code>-DORBconnectionMaxIdle=&lt;integer&gt;</code>	Specifies the number of milliseconds which a network connection can be idle before being shutdown by VisiBroker. By default, this is set to 360 which means that connections will never time-out. This option should be set for Internet applications.



## Executing server applications in Java

A server application is one that offers one or more VisiBroker ORB objects to client applications. A server application may be started with the `vbj` command or it may be activated by the Object Activation Daemon (`oad`).

The following table summarizes the command-line arguments that may be specified for a Java server application.

Options	Description
<code>-DOAipAddr &lt;hostname ip_address&gt;</code>	Specifies the hostname or IP address to be used for the Object Adapter. Use this option if your host has multiple network interfaces and the BOA is associated with only one of those interfaces. If no option is specified, the host's default address is used.
<code>-DOAport &lt;port_number&gt;</code>	Specifies the port number to be used by the object adapter when listening for a new connection.
<code>-DOAid &lt;TPool TSession&gt;</code>	Specifies the thread policy to be used by the BOA. The default is <code>TPool</code> unless you are in backward compatibility mode; in which case, the default is <code>TSession</code> .
<code>-DOAthreadMax &lt;integer&gt;</code>	Specifies the maximum number of threads allowed when <code>OAid TPool</code> is selected. If you do not specify or you specify 0, this selects unlimited number of threads or, to be more precise, a number of threads limited only by your system resources.
<code>-DOAthreadMin &lt;integer&gt;</code>	Specifies the minimum number of threads available in the thread pool. If you do not specify, the default is 0. You can specify this only when <code>OAid TPool</code> is selected.
<code>-DOAthreadMaxIdle &lt;integer&gt;</code>	Specifies the time in seconds during which a thread can exist without servicing any requests. Threads that idle beyond the time specified can be returned to the system. By default, this is set to 300.
<code>-DOAconnectionMax &lt;integer&gt;&gt;</code>	Specifies the maximum number of connections allowed when <code>OAid TSession</code> is selected. If you do not specify, the default is unlimited.
<code>-DOAconnectionMaxIdle &lt;integer&gt;</code>	Specifies the time which a connection can idle without any traffic. Connections that idle beyond this time can be shutdown by VisiBroker. By default, this is set to 0, meaning that connections will never automatically time-out. This option should be set for Internet applications.



# Programmer tools for Java

This chapter describes the programmer tools offered by VisiBroker for Java. In this section, command syntax consists of the commands, the arguments necessary to execute them, and command-line options. Some commands take no arguments, but their options are provided.

The VisiBroker for Java tools provide features which give you greater flexibility in configuring your applications, such as setting classpath and ORB properties. VisiBroker provides a configuration file-based system that lets the user specify the configuration. In addition, in VisiBroker version 6.5 and later, all of these tools are invoked using launchers that are natively built. Previously, UNIX-based launchers were script-based and provided very limited functionality for configuration.

## Options

All VisiBroker for Java programmer's tools have both general and specific options. The specific options for each tool are listed in the section for the tool. All the options in the list are enabled by default and they are preceded by a hyphen (–). To turn off the default value, you can either prepend `-no_` or remove the hyphen. For example, to display a “warning” if a `#pragma` is not recognized, the default value is:

```
warn_unrecognized_pragmas
```

To turn off the default, use the following option:

```
-no_warn_unrecognized_pragmas
```

The general options available to all programmer tools are provided in the following section.

## General options

The following options are common to all programmer tools:

Option	Description
<code>-VBJdebug</code>	Outputs VisiBroker for Java debugging information.
<code>-J&lt;java_option&gt;</code>	Passes the <code>java_option</code> directly to the Java Virtual Machine.
<code>-VBJversion</code>	Outputs the VisiBroker for Java version in use.
<code>-VBJprop &lt;property&gt;=&lt;value&gt;</code>	Passes the specified property to VBJ executable.
<code>-VBJjavavm &lt;vm-name&gt;</code>	Specifies the path, flags to the Java VM. If not specified, the default value <code>java</code> is used.
<code>-VBJclasspath &lt;classpath&gt;</code>	Specifies the classpath. The value entered here precedes the <code>CLASSPATH</code> ENV variable.
<code>-VBJaddJar &lt;jarfile&gt;</code>	Adds <code>&lt;jarfile&gt;</code> to the <code>CLASSPATH</code> before executing the VM. If no absolute path is specified, the jarfile is assumed to be relative to <code>&lt;launcher-location&gt;/../lib</code> .
<code>-VBJconfig &lt;config-file-name&gt;</code>	The path to the configuration file to be used by the launcher. If not specified, the default location is <code>&lt;install-dir&gt;/bin/vbj.config</code> (or <code>vbjc.config</code> for launcher <code>vbjc</code> ).
<code>-help -h -? -usage</code>	Prints usage information.

## idl2ir

This tool allows you to populate an interface repository (IR) with objects defined in an Interface Definition Language (IDL) source file. It is executed using the `idl2ir` command.

### Syntax

```
idl2ir [options] {filename}
```

### Example

```
idl2ir -irep my_repository -replace java_examples/bank/
Bank.idl
```

### Description

The `idl2ir` command takes an IDL file as input, binds itself to an interface repository server and populates the repository with the IDL constructs contained in `filename`. If the repository already contains an item with the same name as an item in the IDL file, the old item will be modified.

### Keywords

The keyword contains both the options listed below and the IDL input files to be processed.

### Options

The following options are available for `idl2ir`.

Option	Description
<code>-D, -define foo[=bar]</code>	Defines a preprocessor macro <code>foo</code> , optionally with a value <code>bar</code> .
<code>-I, -include &lt;dir&gt;</code>	Specifies an additional directory for <code>#include</code> searching.
<code>-P, -no_line_directives</code>	Suppresses the generation of line number information. The default is <code>off</code> .
<code>-H, -list_includes</code>	Prints the full paths of included files on the standard error output. The default is <code>off</code> .
<code>-U, -undefine &lt;foo&gt;</code>	Undefines a preprocessor macro <code>foo</code> .
<code>-C, -retain_comments</code>	Retains comments in preprocessed output. The default is <code>off</code> .
<code>-[no_]idl_strict</code>	Specifies a strict OMG standard interpretation of IDL source. The default is <code>off</code> .
<code>-[no_]builtin (TypeCode Principal)</code>	Creates built-in Type <code>::TypeCode</code> or <code>::Principal</code> . The default is <code>on</code> .
<code>-[no_]warn_unrecognized_pragmas</code>	Displays a warning that appears if a <code>#pragma</code> is not recognized. The default is <code>on</code> .
<code>-[no_]back_compat_mapping</code>	Specifies the use of mapping that is compatible with VisiBroker 3.x.
<code>-[no_]preprocess</code>	Preprocess the input file before parsing. The default is <code>on</code> .
<code>-[no_]preprocess_only</code>	Stops parsing the input file after preprocessing. The default is <code>off</code> .
<code>-[no_]warn_all</code>	Turns all warnings on/off simultaneously. The default is <code>on</code> .
<code>-irep &lt;irep name&gt;</code>	Specifies the name of the interface repository.
<code>-deep</code>	Applies a deep (versus shallow) merge. The default is <code>off</code> .
<code>-replace</code>	Replaces entire repository instead of merging. The default is <code>off</code> .
<code>file1 [file2]...</code>	One or more files to process, or <code>-</code> for stdin.
<code>-h, -help, -usage, -?</code>	Prints help information.

## ir2idl

This tool allows you to create an Interface Definition Language (IDL) source file with objects from an interface repository. It is executed with the `ir2idl` command.

### Syntax

```
ir2idl [options] filename
```

### Example

```
ir2idl -irep my_repository -o my_file
```

### Description

The `ir2idl` command binds to the IR and prints the contents in IDL format.

### Keywords

The keyword contains both the options listed below.

### Options

The following options are available for `ir2idl`.

Option	Description
<code>-irep &lt;irep name&gt;</code>	Specifies the name of the interface repository.
<code>-o &lt;file&gt;</code>	Specifies the name of the output file, or “-” for stdout.
<code>-strict</code>	Specifies strict adherence to OMG-standard code generation. The default is <code>on</code> . The compiler will complain upon occurrences of Micro Focus-proprietary syntax extensions in input IDL.
<code>-version</code>	Displays or prints out the version of VisiBroker that you are currently running.
<code>-h, -help, -usage, -?</code>	Prints help information.

## idl2java

This tool generates Java source code from an IDL source file. It is executed using the `idl2java` command.

### Syntax

```
idl2java [options] {filename}
```

### Example

```
idl2java -no_tie Bank.idl
```

### Description

The `idl2java` command, a Java-based preprocessor, compiles an IDL source file and creates a directory structure containing the Java mappings for the IDL declarations. Typically, one IDL file will be mapped to many Java files because Java allows only one public interface or class per file. IDL file names must end with the `.idl` extension.

### Keywords

The keyword contains both the options listed below and the IDL source file(s) to be processed.

## Options

The following options are available for idl2java:

Option	Description
-D, -define foo[=bar]	Defines a preprocessor macro <code>foo</code> , optionally with a value <code>bar</code> .
-I, -include <dir>	Specifies the full or relative path to the directory for <code>#include</code> files. Used in searching for include files.
-P, -no_line_directives	Suppresses the generation of line number information in the generated code. The default is <code>off</code> .
-H, -list_includes	Prints the full paths of included files on the standard error output.
-compilerflags "\-flag,arg[,.]"	Specifies a comma-separated list of the Java compiler flags: "\-flag,arg[,.]". The first "-" character is escaped.
-compiler <full name>	Specifies full name of Java Compiler class name.
-U, -undefine foo	Undefines a preprocessor macro <code>foo</code> .
-[no_]builtin (TypeCode Principal)	Creates built-in Type <code>::TypeCode</code> or <code>::Principal</code> . The default is <code>on</code> .
-[no_]preprocess	Preprocesses the input file before parsing. The default is <code>on</code> .
-[no_]preprocess_only	Stops parsing the input file after preprocessing. The default is <code>off</code> .
-[no_]warn_all file1 [file2]...	Turns all warnings on/off simultaneously. The default is <code>off</code> . One or more files to process, or "-" for stdin.
-[no_]copy_local_values	Copies values when making colocated calls on CORBA methods. The default is <code>off</code> .
-sealed <pkg> <dest_pkg>	Marks this package as sealed. Code will be generated in <code>dest_pkg</code> or default location.
-no_classloader_aware	Generates classloader aware Java code. The default is <code>on</code> .
-backcompat_compile	Uses the deprecated <code>compile</code> option of <code>jdk1.4.1</code> . The default is <code>off</code> .
-[no_]idl_strict	Specifies strict adherence to OMG standard interpretation of idl source. The default is <code>off</code> .
-[no_]warn_unrecognized_pragmas	Displays a warning that appears if a <code>#pragma</code> is not recognized. The default is <code>on</code> .
-[no_]back_compat_mapping	Specifies the use of IDL mapping that is compatible with VisiBroker 3.x caffeine compiles.
-[no_]boa	Specifies BOA-compatible code generation. The default is <code>off</code> .
-[no_]comments	Suppresses the generation of comments in the code. The default is <code>on</code> .
-[no_]examples	Suppresses the generation of the <code>_example</code> classes. The default is <code>off</code> .
-gen_included_files	Generates code for <code>#included</code> files. The default is <code>off</code> .
-list_files	Lists files written during code generation. The default is <code>off</code> .
-[no_]obj_wrapper	Generates support for object wrappers. The default is <code>off</code> .
-root_dir <path>	Specifies the directory in which the generated files reside.
-[no_]servant	Generates servant (server-side) code. The default is <code>on</code> .
-tie	Generates <code>_tie</code> classes. The default is <code>on</code> .
-[no_]warn_missing_define	Warns if any forward declared interfaces were not defined. The default is <code>on</code> .
-[no_]bind	Suppresses the generation of <code>bind()</code> methods in the generated Helper class. The default is <code>off</code> .
-[no_]compile	When set to <code>on</code> , automatically compiles the Java files. The default is <code>off</code> .
-dynamic_marshall	Specifies that marshaling use DSI/DII model. The default is <code>off</code> .
-idl2package <IDL_name> <pkg>	Overrides default package for a given IDL container type.
-[no_]invoke_handler	Generates invocation handler class for EJB. Default is <code>off</code> .

Option	Description
-[no_]narrow_compliance	Generated code for narrow is compliant (versus 3.x compatible). The default is <code>on</code> .
-[no_]Object_methods	Generate all methods on Objects. The default is <code>on</code> .
-package <pkg>	Specifies the root package for generated code.
-stream_marshall	Specifies that marshaling use the stream model. The default is <code>on</code> .
-strict	Specifies strict adherence to OMG standard for code generation. The default is <code>off</code> .
-version	Displays the software version number of VisiBroker.
-map_keyword <kwd> <replacement>	Specifies the keyword to avoid and designates its replacement.
-h, -help, -usage, -?	Prints help information.

## java2idl

This command generates an IDL from a Java class file (in Java byte code). You can enter one or more Java classes (in byte codes). If you enter more than one class name, make sure you include spaces in between the class names.

If you use a class that extends `org.omg.CORBA.IDLEntity` in some Java remote interface definition, it must have the following:

- an IDL file that contains the IDL definition for that type because the `org.omg.CORBA.IDLEntity` interface is a signature interface that marks all IDL data types mapped to Java.
- all related (supporting) classes according to the CORBA 3.0 IDL2Java Specification from the Object Management Group (OMG).

If you use a class that extends `org.omg.CORBA.IDLEntity` in some Java remote interface definition, use the `-import <IDL files>` directive in the `java2idl` tool's command line.

For more information, refer to the CORBA 3.0 IDL2Java Specification located at <http://www.omg.org/>.

### Note

To use this command, you must have a virtual machine supporting JDK 1.3 or later.

### Syntax

```
java2idl [options] {filename}
```

### Example

```
java2idl -o final.idl Account Client Server
```

### Description

Use this command when you want to generate an IDL from your Java byte code. You might want to use this when you have existing Java byte code and want to create an IDL file from it so it can be used with some other programming language like C++, COBOL, or Smalltalk.

Using the option `"-o"` as shown in the above example, the three Java byte code files (Account, Client, Server) are output to a file, `final.idl`. By default, the output is displayed on the screen.

## Keywords

The keyword contains both the options listed below and the Java byte code file(s) to be processed.

## Options

The following options are available for `java2idl`.

Option	Description
<code>-D, -define foo[=bar]</code>	Defines a preprocessor macro <code>foo</code> , optionally with a value <code>bar</code> .
<code>-I, -include &lt;dir&gt;</code>	Specifies the full or relative path to the directory for <code>#include</code> files. Used in searching for include files.
<code>-P, -no_line_directives</code>	Suppresses the generation of line number information in the generated code. The default is <code>off</code> .
<code>-H, -list_includes</code>	Prints the full paths of included files on the standard error output.
<code>-U, -undefine foo</code>	Undefines a preprocessor macro <code>foo</code> .
<code>-[no_]idl_strict</code>	Specifies strict adherence to OMG standard interpretation of idl source. The default is <code>off</code> .
<code>-[no_]warn_unrecognized_pragmas</code>	Displays a warning that appears if a <code>#pragma</code> is not recognized. The default is <code>on</code> .
<code>-[no_]back_compat_mapping</code>	Specifies the use of mapping that is compatible with VisiBroker 3.x caffeine compile.
<code>-exported &lt;pkg&gt;</code>	The type definitions in the specified package will be exported.
<code>-[no_]export_all</code>	Exports the type definitions in all packages. The default is <code>off</code> .
<code>-import &lt;IDL file name&gt;</code>	Loads extra IDL definitions.
<code>-imported &lt;pkg&gt; &lt;IDL file name&gt;</code>	The type definitions in the specified package should be considered imported from the specified IDL file and should not be code generated
<code>-o &lt;file&gt;</code>	Specifies the name of an output file, or <code>-</code> for stdout.
<code>-strict</code>	Specifies strict adherence to OMG standard for code generation. The default is <code>off</code> .
<code>class1 [class2]...</code>	One or more Java Classes to process.
<code>-version</code>	Displays the software version number of VisiBroker.
<code>-h, -help, -usage, -?</code>	Prints help information.

## java2iio

This command allows you to use the Java language to define IDL interfaces instead of using IDL. You can enter one or more Java class names (in Java byte code). If you enter more than one class name, make sure you include spaces in between the class names. Use fully scoped class names.

### Note

To use this command, you must have a Java Virtual Machine supporting JDK 1.3 or later.

If you use a class that extends `org.omg.CORBA.IDLEntity` in some Java remote interface definition, it must have the following:

- an IDL file that contains the IDL definition for that type because the `org.omg.CORBA.IDLEntity` interface is a signature interface that marks all IDL data types mapped to Java.
- all related (supporting) classes according to the CORBA 3.0 IDL2Java Specification from the Object Management Group (OMG).



If you use a class that extends `org.omg.CORBA.IDLEntity` in some Java remote interface definition, use the `-import <IDL files>` directive in the `java2iiop` tool's command line.

For more information, refer to the CORBA 3.0 IDL2Java Specification located at <http://www.omg.org/>.

## Syntax

```
java2iiop [options] {class name}
```

## Example

```
java2iiop -no_tie Account Client Server
```

## Description

Use `java2iiop` if you have existing Java byte code that you wish to adapt to use distributed objects or if you do not want to write IDL. By using `java2iiop`, you can generate the necessary container classes, client stubs, and server skeletons from Java byte code.

## Note

The `java2iiop` compiler does not support overloaded methods on CORBA interfaces.

## Keywords

The keyword contains both the options listed below and the Java byte code file(s) to be processed.

## Options

The following options are available for `java2iiop`.

Option	Description
<code>-D, define foo[=bar]</code>	Defines a preprocessor macro <code>foo</code> , optionally with a value <code>bar</code> .
<code>-I, -include &lt;dir&gt;</code>	Specifies the full or relative path to the directory for <code>#include</code> files. Used in searching for include files.
<code>-P, -no_line_directives</code>	Suppresses the generation of line number information in the generated code. The default is <code>off</code> .
<code>-H, -list_includes</code>	Prints the full paths of included files on the standard error output.
<code>-U, -undefine foo</code>	Undefines a preprocessor macro <code>foo</code> .
<code>-[no_]idl_strict</code>	Specifies strict adherence to OMG standard interpretation of idl source. The default is <code>off</code> .
<code>-[no_]warn_unrecognized_pragmas</code>	Displays a warning that appears if a <code>#pragma</code> is not recognized. The default is <code>on</code> .
<code>-[no_]back_compat_mapping</code>	Specifies the use of mapping that is compatible with VisiBroker 3.x. The default is <code>off</code> .
<code>-exported &lt;pkg&gt;</code>	Specifies the name of an exported package.
<code>-[no_]export_all</code>	Exports all packages. The default is <code>off</code> .
<code>-import &lt;IDL file name&gt;</code>	Loads extra IDL definitions.
<code>-imported &lt;pkg&gt; &lt;idl_file_name&gt;</code>	Specifies the name of an imported package.
<code>-[no_]boa</code>	Specifies BOA-compatible code generation. The default is <code>off</code> .
<code>-[no_]comments</code>	Suppresses the generation of comments in the code. The default is <code>on</code> .
<code>-[no_]examples</code>	Suppresses the generation of the <code>_example</code> classes. The default is <code>off</code> .

Option	Description
-gen_included_files	Generates code for #included files. The default is <code>off</code> .
-list_files	Lists files written during code generation. The default is <code>off</code> .
-[no_]obj_wrapper	Generates support for object wrappers. The default is <code>off</code> .
-root_dir <path>	Specifies the directory in which the generated files reside.
-[no_]servant	Generates servant (server-side) code. The default is <code>on</code> .
-tie	Generates <code>_tie</code> classes. The default is <code>on</code> .
-[no_]warn_missing_define	Warns if any forward declared file names were never defined. The default is <code>on</code> .
-[no_]bind	Suppresses the generation of <code>bind()</code> methods in the generated Helper class. The default is <code>on</code> .
-[no_]compile	Automatically generates Java files. When set to <code>on</code> , also automatically compiles the Java files. The default is <code>off</code> .
-compiler	Specifies the Java compiler to be used. This option is ignored if the <code>-compile</code> option is not set.
-compilerflags "\-flag,arg[,..]"	Specifies a comma-separated list of the Java compiler flags to be passed to the Java compiler. The first "-" character is escaped.
-C, -retain_comments	Retains comments in preprocessed output. The default is <code>off</code> .
-[no_]builtin (TypeCode Principal)	Creates built-in Type <code>::TypeCode</code> or <code>::Principal</code> . The default is <code>on</code> .
-[no_]preprocess	Preprocesses the input file before parsing. The default is <code>on</code> .
-[no_]preprocess_only	Stops parsing the input file after preprocessing. The default is <code>off</code> .
-[no_]warn_all	Turns all warnings on/off simultaneously. The default is <code>off</code> .
-[no_]copy_local_values	Copies values when making colocated calls on CORBA methods. The default is <code>off</code> .
-no_classloader_aware	Generates classloader aware Java code. The default is <code>on</code> .
-backcompat_compile	Uses the deprecated <code>compile</code> option of <code>jdk1.4.1</code> . The default is <code>off</code> .
-[no_]idntity_array_mapping	Maps array of <code>IDLEntity</code> to <code>boxedIDL</code> in <code>boxedRMI</code> . The default is <code>off</code> .
class1 [class2]...	One or more Java classes to process.
-dynamic_marshall	Specifies that marshaling use DSI/DII model. The default is <code>off</code> .
-idl2package <IDL name> <pkg>	Overrides default package for a given IDL container type.
-[no_]invoke_handler	Generates invocation handler class for EJB. Default is <code>on</code> .
-[no_]narrow_compliance	Generated code is compliant (versus 3.x compatible). the default is <code>on</code> .
-[no_]Object_methods	Generates all methods defined in <code>java.lang.Object</code> methods, such as <code>string</code> and <code>equals</code> . The default is <code>on</code> .
-package <pkg>	Specifies the root package for generated code.
-sealed <pkg> <destination_pkg>	Generates stubs and skeletons for remote interfaces in the specified package to the <code>org.omg.stub</code> and the destination package respectively.
-stream_marshall	Specifies that marshaling use the stream model. The default is <code>on</code> .
-strict	Specifies strict adherence to OMG standard for code generation. The default is <code>off</code> .
-version	Displays the software version number of VisiBroker.
-map_keyword <kwd> <replacement>	Specifies the keyword to avoid and designates its replacement.
-h, -help, -usage, -?	Prints help information.

# vbj

This command starts the local Java interpreter.

## Syntax

```
vbj [options] [arguments normally sent to java VM] {class}
    [arg1 arg2 ...]
```

Where:

Argument	Description
{class}	Specifies the name of the class to be executed.
[arg1 arg2 ...]	Specific arguments to be passed to the class.

## Example

```
vbj Server
```

## Description

Java applications have certain limitations not faced by applications written in other languages. The `vbj` command provides options to work around some of these limitations, and it is the preferred method to launch VisiBroker applications. The `vbj` command performs the following actions:

- Passes CLASSPATH and arguments to the Java VM according to command line options and configuration file definition.
- Customizes launching behavior for each application using customized configuration files.
- Embeds a JVM within the same process as the launcher.
- Runs application as daemon in Windows platforms only.

The following options are available for `vbj`.

Argument	Description
-debug, -VBJdebug	Turns on launcher debug output.
-h, -help, -usage, -?	Prints launcher command help.
-version	Displays or prints out the version of VisiBroker for Java that you are currently running.
-install <server-name>	Installs a Windows NT/2000 service.
-remove <server-name>	Removes a Windows NT/2000 service.
-javahome <jvm-directory>	The installation directory of the Java VM.
-classicvm	Selects the VM type to be run. Note that you can also use the -J flag to pass VM type. For example:
-hotspotvm / -clientvm	
-servervm	<pre>vbj -J-server Server</pre>
-classpath	Modifies the classpath. The value of this argument is either appended to (/a), prepended to (/p), or completely replaces (/r) any existing classpath setting in the environment. Only the last occurrence of the classpath family argument is honored. Note that -VBJclasspath is equivalent to -classpath/p and -VBJaddJar is equivalent to -classpath/a.
-classpath/a	
-classpath/p	
-classpath/r	
-VBJclasspath	
-VBJaddJar	
-verbose	Turns on verbose output from the Java VM.
-VBJconfig <config-file-name>	Uses an alternate configuration file and replaces the default configuration file.

Argument	Description
-jpda [ : [ { paused   running } ] [ , address = [ <host> : ] <port#> ] ]	Turns on JPDA debug. For example:  -jpda : running , address = 23456 Starts the JVM with JPDA turned on. A JPDA debugger can then attach to this application on port 23456 to debug the application. Also ensure that in the launcher's configuration file (for example <install-dir>/bin/vbj.config) the following line is present:  jpda running , address = 23456
-javacmd	Prints an equivalent Java command. This is useful when vbj launcher is not required and the application is executed through java launcher.
-VBJprop <name>=<value>	Passes the property name and value pair into the Java Virtual Machine as a System Property by adding it as a -D<name> [= <value>] parameter to the executed "java".

## vbjc

This command is used to compile Java source code that can import VisiBroker classes. When called, it:

- Sets CLASSPATH, arguments to be passed to Java VM according to command line options and configuration file definition.
- Adds the VisiBroker-standard JAR files into the CLASSPATH.
- Launches javac main class: com.sun.tools.javac.Main.

### Syntax

```
vbjc [arguments normally passed to javac]
```

### Example

```
vbjc Server.java
```

The vbjc command supports the command line options described in the following table.

Argument	Description
-VBJdebug	Displays or prints out the VisiBroker for Java debugging information.
-VBJversion	Displays or prints out the version of VisiBroker for Java that you are currently running.
-VBJjavavm <vmname>	Specifies the path to the Java Virtual Machine to be used. Default is java.
-VBJclasspath <classpath>	Specifies the classpath. Precedes CLASSPATH environment variable.
-VBJaddJar <jarfile>	Appends <install-dir>/lib/<jarfile> to the CLASSPATH before executing the VM. If no absolute path is specified, the jarfile is assumed to be relative to <launcher-location>/../lib.
-VBJconfig <config-file-name>	Specifies the path to the configuration file to be used by the launcher. If not specified, the default location is <install-dir>/bin/vbj.config vbjc.config.
-help -h -? -usage	Prints usage information.
-VBJcompiler <class-name>	Overwrites the default javac main class.

## Specifying the classpath

The following sources are merged in the following order:

- 1 JAR and ZIP files in the patches directory (`$VBROKERDIR/lib/patches/`) (Note that the patches directory is not automatically created under the `$VBROKERDIR/lib/` directory. It has to be created by the user explicitly.)
- 2 The classpath specified in `-VBJclasspath`, `-classpath/p`, or `-classpath/r`
- 3 The `$CLASSPATH` exported in the environment (if `-classpath/r` is not specified)
- 4 The classpath specified in `-classpath/a`
- 5 The default JAR files required by the launcher
- 6 JAR files added using `VBJaddJar` and assumed to be located in the `<launcher location>/../lib` directory if no absolute path is specified
- 7 Classpath added using `addpath` directive in the configuration file
- 8 JAR files added using `addjars` directive in the configuration file
- 9 The current directory

The merged classpath is passed to the Java Virtual Machine using `-Djava.class.path`.

## Specifying the JVM

By default the JVM is located as follows:

- 1 Searching the directories specified in the `PATH`.
- 2 Using the information specified through `javahome` directive in the configuration file (the default configuration file for `vbj` is `vbj.config`).

The above procedure can be overridden using the `-VBJjavavm` or `-javahome` (only supported in `vbj`) option. With `-VBJjavavm` either the name of the VM or the full path to the VM can be specified. The option `-javahome` has the same semantics as the `javahome` configuration file directive. Note that if no VM is found using the `-VBJjavavm` or `-javahome` options, no further search is carried out to locate the default JVM, and the program terminates with an error.

## idl2wsj

Option	Description
<code>-encoding_wsi_only</code>	Generate specific WS-I encodings only. Defaults to OFF
<code>-encoding_soap_only</code>	Generate specific SOAP encodings only. Defaults to OFF
<code>-wsdl_file_name</code>	Name of the generated WSDL file. Defaults to the name of IDL
<code>-wsdl_namespace</code>	Namespace of the generated WSDL. Defaults to the name of the IDL file
<code>-gen_java_bridge</code>	Generate VisiBroker for Java bridge code. Defaults to OFF.
<code>-root_dir</code>	Directory in which generated files should reside



# IDL to Java mapping

This section describes the basics of the VisiBroker for Java current IDL-to-Java language mapping, as implemented by the `idl2java` compiler. VisiBroker for Java conforms with the *OMG IDL/Java Language Mapping Specification*.

See the latest version of the *OMG IDL/Java Language Mapping Specification* for complete information about the following:

- Mapping pseudo-objects to Java
- Server-side mapping
- Java ORB portability interfaces

## Names

In general, IDL names and identifiers are mapped to Java names and identifiers with no change.

If a naming conflict is generated in the mapped Java code, the conflict is resolved by prepending an underscore (`_`) to the mapped name.

In addition, because of the nature of the Java language, a single IDL construct may be mapped to several (differently named) Java constructs. The “additional” names are constructed by appending a descriptive suffix. For example, the IDL interface `AccountManager` is mapped to the Java interface `AccountManager` and additional Java classes `AccountManagerOperations`, `AccountManagerHelper`, and `AccountManagerHolder`.

In the exceptional cases that the “additional” names may conflict with other mapped IDL names, the resolution rule described above is applied to the other mapped IDL names. In other words, the naming and use of required “additional” names takes precedence.

For example, an interface whose name is `fooHelper` or `fooHolder` is mapped to `_fooHelper` or `_fooHolder` respectively, regardless of whether an interface named `foo` exists. The helper and holder classes for interface `fooHelper` are named `_fooHelperHelper` and `_fooHelperHolder`.

IDL names that would normally be mapped unchanged to Java identifiers that conflict with Java reserved words will have the collision rule applied.

## Reserved names

The mapping reserves the use of several names for its own purposes. The use of any of these names for a user-defined IDL type or interface (assuming it is also a legal IDL name) will result in the mapped name having an underscore (`_`) prepended. Reserved names are as follows:

- The Java class `<type>Helper`, where `<type>` is the name of an IDL user-defined type.
- The Java class `<type>Holder`, where `<type>` is the name of an IDL user-defined type (with certain exceptions such as `typedef` aliases).
- The Java classes `<basicJavaType>Holder`, where `<basicJavaType>` is one of the Java primitive data types that is used by one of the IDL basic data types.

- The nested scope Java package name `<interface>Package`, where `<interface>` is the name of an IDL interface.
- The Java classes `<interface> Operations`, `<interfaces> POA`, and `<interface>POATie`, when `<interface>` is the name of an IDL interface type.

## Reserved words

The mapping reserves the use of several words for its own purposes. The use of any of these words for a user-defined IDL type or interface (assuming it is also a legal IDL name) will result in the mapped words having an underscore (`_`) prepended. The reserved keywords in the Java language are as follows:

<code>abstract</code>	<code>abstractBase</code>	<code>boolean</code>	<code>break</code>
<code>byte</code>	<code>case</code>	<code>catch</code>	<code>char</code>
<code>class</code>	<code>const</code>	<code>continue</code>	<code>default</code>
<code>do</code>	<code>double</code>	<code>else</code>	<code>extends</code>
<code>false</code>	<code>final</code>	<code>finally</code>	<code>float</code>
<code>for</code>	<code>goto</code>	<code>if</code>	<code>implements</code>
<code>import</code>	<code>instanceof</code>	<code>int</code>	<code>interface</code>
<code>local</code>	<code>long</code>	<code>native</code>	<code>new</code>
<code>null</code>	<code>package</code>	<code>private</code>	<code>protected</code>
<code>public</code>	<code>return</code>	<code>short</code>	<code>static</code>
<code>super</code>	<code>switch</code>	<code>synchronized</code>	<code>this</code>
<code>throw</code>	<code>throws</code>	<code>transient</code>	<code>true</code>
<code>try</code>	<code>void</code>	<code>volatile</code>	<code>while</code>

## Modules

An IDL module is mapped to a Java package with the same name. All IDL type declarations within the module are mapped to corresponding Java class or interface declarations within the generated package.

IDL declarations not enclosed in any modules are mapped into the (unnamed) Java global scope.

The following code sample shows the Java code generated for a type declared within an IDL module.

```
/* From Example.idl: */
module Example { .... };
// Generated java
package Example;
...
```

## Basic types

The following table shows how the defined IDL types map to basic Java types.

IDL type	Java type
<code>boolean</code>	<code>boolean</code>
<code>char</code>	<code>char</code>
<code>wchar</code>	<code>char</code>
<code>octet</code>	<code>byte</code>
<code>string</code>	<code>java.lang.String</code>
<code>wstring</code>	<code>java.lang.String</code>



IDL type	Java type
short	short
unsigned short	short
long	int
unsigned long	int
longlong	long
unsigned longlong	long
float	float
double	double

When there is a potential mismatch between an IDL type and its mapped Java type, a standard CORBA exception can be raised. For the most part, exceptions are in two categories,

- Range of the Java type is larger than the IDL type. For example, Java chars are a superset of IDL chars.
- Because there is no support in Java for unsigned types, the developer is responsible for ensuring that large unsigned IDL type values are handled correctly as negative integers in Java.

Additional details are described in the following sections.

## IDL type extensions

This section summarizes the VisiBroker for Java support for IDL type extensions. The first table provides a summary for quick look-ups. This is followed by the IDL extensions for new types table summarizing support for new types.

Type	Supported in VisiBroker
longlong	yes
unsigned longlong	yes
long double	no <sup>1</sup>
wchar	yes <sup>2</sup>
wstring	yes <sup>2</sup>
fixed	no <sup>1</sup>

<sup>1</sup>VisiBroker for Java will support any future release of OMG standard implementation.

<sup>2</sup>UNICODE is used "on the wire."

New types	Description
longlong	64-bit signed 2's complements integers
unsigned longlong	64-bit unsigned 2's complements integers
long double	IEEE Standard 754-1985 double extended floating point
wchar	Wide characters
wstring	Wide strings
fixed	Fixed-point decimal arithmetic (31 significant digits)

## Holder classes

Holder classes support OUT and INOUT parameter passing modes and are available for all the basic IDL data types in the `org.omg.CORBA` package. Holder classes are generated for all named user-defined types except those defined by typedefs. For more information, see the Java API Reference, VisiBroker APIs, `org.omg.CORBA` package section.

For user-defined IDL types, the holder class name is constructed by appending `Holder` to the mapped Java name of the type.

For the basic IDL data types, the holder class name is the Java type name (with its initial letter capitalized) to which the data type is mapped with an appended `Holder`, for example, `IntHolder`.

Each holder class has a constructor from an instance, a default constructor, and has a public instance member, `value`, which is the typed value. The default constructor sets the value field to the default value for the type as defined by the Java language:

- `false` for boolean
- `null` for values
- `0` for numeric and char types
- `null` for strings
- `null` for object references

To support portable stubs and skeletons, `Holder` classes for user-defined types also implement the `org.omg.CORBA.portable.Streamable` interface.

The holder classes for the basic types are defined in the following code sample. They are in the `org.omg.CORBA` package.

```
// Java
package org.omg.CORBA;
final public class ShortHolder implements Streamable {
    public short value;
    public ShortHolder() {}
    public ShortHolder(short initial) {
        value = initial;
    }
    ...//implementation of the streamable interface
}
final public class IntHolder implements Streamable {
    public int value;
    public IntHolder() {}
    public IntHolder(int initial) {
        value = initial;
    }
    ...//implementation of the streamable interface
}
final public class LongHolder implements Streamable {
    public long value;
    public LongHolder() {}
    public LongHolder(long initial) {
        value = initial;
    }
    ...//implementation of the streamable interface
}
final public class ByteHolder implements Streamable {
    public byte value;
    public ByteHolder() {}
    public ByteHolder(byte initial) {
        value = initial;
    }
    ...//implementation of the streamable interface
}
final public class FloatHolder implements Streamable {
```

```

    public float value;
    public FloatHolder() {}
    public FloatHolder(float initial) {
        value = initial;
    }
    ...//implementation of the streamable interface
}
final public class DoubleHolder implements Streamable {
    public double value;
    public DoubleHolder() {}
    public DoubleHolder(double initial) {
        value = initial;
    }
    ...//implementation of the streamable interface
}
final public class CharHolder implements Streamable {
    public char value;
    public CharHolder() {}
    public CharHolder(char initial) {
        value = initial;
    }
    ...//implementation of the streamable interface
}
final public class BooleanHolder implements Streamable {
    public boolean value;
    public BooleanHolder() {}
    public BooleanHolder(boolean initial) {
        value = initial;
    }
    ...//implementation of the streamable interface
}
final public class StringHolder implements Streamable {
    public java.lang.String value;
    public StringHolder() {}
    public StringHolder(java.lang.String initial) {
        value = initial;
    }
    ...//implementation of the streamable interface
}

final public class ObjectHolder implements Streamable {
    public org.omg.CORBA.Object value;
    public ObjectHolder() {}
    public ObjectHolder(org.omg.CORBA.Object initial) {
        value = initial;
    }
    ...//implementation of the streamable interface
}
final public class ValueBaseHolder implements Streamable {
    public java.io.Serializable value;
    public ValueBaseHolder() {}
    public ValueBaseHolder(java.io.Serializable initial) {
        value = initial;
    }
    ...//implementation of the streamable interface
}
final public class AnyHolder implements Streamable {
    public Any value;
    public AnyHolder() {}
    public AnyHolder(Any initial) {

```

```

        value = initial;
    }
    ...//implementation of the streamable interface
}
final public class TypeCodeHolder implements Streamable {
    public TypeCode value;
    public TypeCodeHolder() {}
    public TypeCodeHolder(TypeCode initial) {
        value = initial;
    }
    ...//implementation of the streamable interface
}
final public class PrincipalHolder implements Streamable {
    public Principal value;
    public PrincipalHolder() {}
    public PrincipalHolder(Principal initial) {
        value = initial;
    }
    ...//implementation of the streamable interface
}

```

The following code sample shows the Holder class for a user-defined type <foo>.

```

// Java
final public class <foo>Holder
    implements org.omg.CORBA.portable.Streamable {
    public <foo> value;
    public <foo>Holder() {}
    public <foo>Holder(<foo> initial) {}
    public void _read(org.omg.CORBA.portable.InputStream i)
        {...}
    public void _write
        (org.omg.CORBA.portable.OutputStream o)
        {...}
    public org.omg.CORBA.TypeCode _type() {...}
}

```

## Java null

The Java null may only be used to represent null CORBA object references and valuetypes (including recursive valuetypes). For example, a zero length string, rather than null must be used to represent the empty string. This is also true for arrays and any constructed type, except for valuetypes. If you attempt to pass a null for a structure, it will raise a `NullPointerException`.

## Boolean

The IDL type `boolean` is mapped to the Java type `boolean`. The IDL constants `TRUE` and `FALSE` are mapped to the Java constants `true` and `false`.

## Char

IDL characters are 8-bit quantities representing elements of a character set while Java characters are 16-bit unsigned quantities representing Unicode characters. To enforce type-safety, the Java CORBA run-time asserts range validity of all Java `chars` mapped from IDL `chars` when parameters are marshaled during method invocation. If the `char` falls outside the range defined by the character set, a `CORBA::DATA_CONVERSION` exception is thrown.

The IDL `wchar` maps to the Java `char` type.

## Octet

The IDL type `octet`, an 8-bit quantity, is mapped to the Java type `byte`.

## String

The IDL type `string`, both bounded and unbounded variants, is mapped to the Java type `java.lang.String`. Range checking for characters in the string as well as bounds checking of the string are done at marshal time.

## WString

The IDL type `wstring`, used to represent Unicode strings, is mapped to the Java type `java.lang.String`. Bounds checking of the string is done at marshal time.

## Integer types

IDL `short` and `unsigned short` map to Java type `short`. IDL `long` and `unsigned long` map to Java type `int`.

### Note

Because there is no support in Java for unsigned types, the developer is responsible for ensuring that negative integers in Java are handled correctly as large unsigned values.

## Floating point types

The IDL floating point types `float` and `double` map to a Java class containing the corresponding data type.

## Helper classes

All user-defined IDL types have an additional “helper” Java class with the suffix `Helper` appended to the type name generated. Several static methods needed to manipulate the type are supplied:

- Any insert and extract operations for the type
- Getting the repository id
- Getting the typecode
- Reading and writing the type from and to a stream

For any user-defined IDL type `<typename>`, the following code sample is the Java code generated for the type. The helper class for a mapped IDL interface has a narrow operation defined for it.

```
// generated Java helper
public class <typename>Helper {
    public static void insert(org.omg.CORBA.Any a, <typename> t);
    public static <typename> extract(org.omg.CORBA.Any a);
    public static org.omg.CORBA.TypeCode type();
    public static String id();
    public static <typename> read( org.omg.CORBA.portable.InputStream
        istream);
    {...}
    public static void write(
        org.omg.CORBA.portable.OutputStream ostream, <typename> value)
        {...}
    // only for interface helpers
    public static <typename> narrow(org.omg.CORBA.Object obj);
}
```

The following code sample shows the mapping of a named type to Java helper class.

```
// IDL - named type
struct st {long f1, String f2};
// generated Java
public class stHelper {
    public static void insert(org.omg.CORBA.Any any, st s) {...}
    public static st extract(org.omg.CORBA.Any a) {...}
    public static org.omg.CORBA.TypeCode type() {...}
    public static String id() {...}
    public static st read(org.omg.CORBA.InputStream is) {...}
    public static void write(org.omg.CORBA.OutputStream os, st s) {...}
}
```

The following code sample shows mapping of a typedef sequence to Java helper class.

```
// IDL - typedef sequence
typedef sequence <long> IntSeq;
// generated Java helper
public class IntSeqHelper {
    public static void insert(org.omg.CORBA.Any any, int[] seq);
    public static int[] extract(org.omg.CORBA.Any a){...}
    public static org.omg.CORBA.TypeCode type(){...}
    public static String id(){...}
    public static int[] read(org.omg.CORBA.portable.InputStream is)
        {...}
    public static void write(
        org.omg.CORBA.portable.OutputStream os, int[] seq)
        {...}
}
```

## Constants

Constants are mapped depending upon the scope in which they appear.

### Constants within an interface

Constants declared within an IDL interface are mapped to `public static final` fields in the Java interface `Operations` class corresponding to the IDL interface.

The following code sample shows the mapping of an IDL constant within a module to a Java class.

```

/* From Example.idl: */
module Example {
    interface Foo {
        const long aLongerOne = -321;
    };
};

// Foo.java
package Example;
public interface Foo extends
com.inprise.vbroker.CORBA.Object,
    Example.FooOperations,
    org.omg.CORBA.portable.IDLEntity {
}

// FooOperations.java
package Example;
public interface FooOperations {
    public final static int aLongerOne = (int)-321;
}

```

### Constants NOT within an interface

Constants declared within an IDL module are mapped to a public interface with the same name as the constant and containing a `public static final` field named `value`. This field holds the constant's value.

#### Note

The Java compiler normally inlines the value when the class is used in other Java code.

The following code sample shows the mapping of an IDL constant within a module to a Java class.

```

/* From Example.idl: */
module Example {
    const long aLongOne = -123;
};

// Generated java
package Example;
public interface aLongOne {
    public final static int value = (int) -123;
}

```

## Constructed types

IDL constructed types include `enum`, `struct`, `union`, `sequence`, and `array`. The types `sequence` and `array` are both mapped to the Java `array` type. The IDL constructed types `enum`, `struct`, and `union` are mapped to a Java class that implements the semantics of the IDL type. The Java class generated will have the same name as the original IDL type.

### Enum

An IDL `enum` is mapped to a Java `final` class with the same name as the `enum` type which declares a `value` method, two static data members per label, an integer conversion method, and a private constructor. The following code sample is an example of an IDL `enum` mapped to a Java `final` class:

```
// Generated java
public final class <enum_name> {
    //one pair for each label in the enum
    public static final int _<label> = <value>;
    public static final <enum_name> <label> =
        new <enum_name>(_<label>);

    public int value() {...}
    //get enum with specified value
    public static <enum_name> from_int(int value);
    //constructor
    protected <enum_name>(int) {...}
}
```

One of the members is a `public static final`, which has the same name as the IDL `enum` label. The other has an underscore (`_`) prepended and is used in `switch` statements.

The `value` method returns the integer value. Values are assigned sequentially starting with 0. If the `enum` has a label named `value`, there is no conflict with the `value()` method in Java.

There will be only one instance of an `enum`. Since there is only one instance, pointer equality tests will work correctly; that is, the default `java.lang.Object` implementation of `equals()` and `hash()` will automatically work correctly for an enumeration's singleton object.

The Java class for the `enum` has an additional method, `from_int()`, which returns the `enum` with the specified value.

The holder class for the `enum` is also generated. Its name is the enumeration's mapped Java classname with `Holder` appended to it as follows:

```
public class <enum_name>Holder implements
    org.omg.CORBA.portable.Streamable {
    public <enum_name> value;
    public <enum_name>Holder() {}
    public <enum_name>Holder(<enum_name> initial) {...}
    public void _read(org.omg.CORBA.portable.InputStream i)
        {...}
    public void _write(
        org.omg.CORBA.portable.OutputStream o)
        {...}
    public org.omg.CORBA.TypeCode _type() {...}
}
```



The following code sample shows the IDL mapped to Java for enum.

```
// IDL
module Example {
    enum EnumType { first, second, third };
};
// generated Java
public final class EnumType
    implements org.omg.CORBA.portable.IDLEntity {
    public static final int _first = 0;
    public static final int _second = 1;
    public static final int _third = 2;
    public static final EnumType first = new EnumType(_first);
    public static final EnumType second = new EnumType(_second);
    public static final EnumType third = new EnumType(_third);
    protected EnumType (final int _vis_value) { ... }
    public int value () { ... }
    public static EnumType from_int (final int _vis_value) { ... }
    public java.lang.String toString() { ... }
}
public final class EnumTypeHolder
    implements org.omg.CORBA.portable.Streamable {
    public OtherExample.EnumType value;
    public EnumTypeHolder () { ... }
    public EnumTypeHolder (final OtherExample.EnumType _vis_value) { ... }
    public void _read (final org.omg.CORBA.portable.InputStream input) { ... }
    public void _write (final org.omg.CORBA.portable.OutputStream output) {
... }
    public org.omg.CORBA.TypeCode _type () { ... }
    public boolean equals (java.lang.Object o) {...}
}
```

## Struct

An IDL struct is mapped to a final Java class with the same name that provides instance variables for the fields in IDL member ordering and a constructor for all values. A null constructor is also provided which allows the structure's fields to be initialized later. The Holder class for the struct is also generated. Its name is the struct's mapped Java classname with Holder appended to it as follows:

```
final public class <class>Holder implements
    org.omg.CORBA.portable.Streamable {
    public <class> value;
    public <class>Holder() {}
    public <class>Holder(<class> initial) {...}
    public void _read(org.omg.CORBA.portable.InputStream i)
        {...}
    public void _write
        (org.omg.CORBA.portable.OutputStream o)
        {...}
    public org.omg.CORBA.TypeCode _type() {...}
}
```

The following code sample shows the mapping of an IDL struct to Java.

```

    /* From Example.idl: */
    module Example {
        struct StructType {
            long field1;
            string field2;
        };
    };
// generated Java
public final class StructType
    implements org.omg.CORBA.portable.IDLEntity {
    public int field1;
    public java.lang.String field2;
    public StructType () { ... }
    public StructType (final int field1,
        final java.lang.String field2) { ... }
    public java.lang.String toString() { ... }
    public boolean equals (java.lang.Object o) {...}
public final class StructTypeHolder implements
    org.omg.CORBA.portable.Streamable {
    public Example.StructType value;
    public StructTypeHolder () { ... }
    public StructTypeHolder (final Example.StructType _vis_value)
        { ... }
    public void _read (final org.omg.CORBA.portable.InputStream input)
        { ... }
    public void _write (final org.omg.CORBA.portable.OutputStream output)
        { ... }
    public org.omg.CORBA.TypeCode _type () { ... }
}

```

## Union

An IDL union is given the same name as the final Java class, and mapped to it. It provides the following:

- Default constructor
- Accessor method for the union's discriminator, named `discriminator()`
- Accessor method for each branch
- Modifier method for each branch
- Modifier method for each branch having more than one case label
- Default modifier method, if needed

If there is a name clash with the mapped union type name or any of the field names, the normal name conflict resolution rule is used: prepend an underscore for the discriminator.

The branch accessor and modifier methods are overloaded and named after the branch. Accessor methods shall raise the `CORBA::BAD_OPERATION` system exception if the expected branch has not been set.

If there is more than one case label corresponding to a branch, the simple modifier method for that branch sets the discriminant to the value of the first case label. In addition, an extra modifier method which takes an explicit discriminator parameter is generated.

If the branch corresponds to the `default` case label, then the modifier method sets the discriminant to a value that does not match any other case labels.

It is illegal to specify a union with a default case label if the set of case labels completely covers the possible values for the discriminant. It is the responsibility of the Java code generator (for example, the IDL compiler, or other tool) to detect this situation and refuse to generate illegal code.

A default method `_default()` is created if there is no explicit default case label, and the set of case labels does not completely cover the possible values of the discriminant. It will set the value of the union to be an out-of-range value.

The holder class for the union is also generated. Its name is the union's mapped Java classname with `Holder` appended to it as follows:

This code sample shows the Holder class for a union.

```
final public class <union_class>Holder
    implements org.omg.CORBA.portable.Streamable {
    public <union_class> value;
    public <union_class>Holder() {}
    public <union_class>Holder(<union_class> initial) {...}
    public void _read(org.omg.CORBA.portable.InputStream i)
        {...}
    public void _write(
        org.omg.CORBA.portable.OutputStream o)
        {...}
    public org.omg.CORBA.TypeCode _type() {...}
}
```

The following code sample shows the mapping of an IDL union to Java.

```
/* From Example.idl: */
module Example {
    enum EnumType { first, second, third, fourth, fifth,
        sixth };
    union UnionType switch (EnumType) {
        case first: long win;
        case second: short place;
        case third:
        case fourth: octet show;
        default: boolean other;
    };
};
// Generated java
final public class UnionType {
    //constructor
    public UnionType() {...}
    //discriminator accessor
    public int discriminator() { ... }
    //win
    public int win() { ... }
    public void win(int value) { ... }
    //place
    public short place() { ... }
    public void place(short value) { ... }
    //show
    public byte show() { ... }
    public void show(byte value) { ... }
    public void show(int discriminator, byte value) { ... }
    //other
```

```

        public boolean        other() {...}
        public void          other(boolean value) { ... }
        public java.lang.String to String () { ...}
        public boolean equals (java.lang.Object o) { ...}
    }
    final public class UnionTypeHolder {
        implements org.omg.CORBA.portable.Streamable {
        public UnionType value;
        public UnionTypeHolder() {}
        public UnionTypeHolder(UnionType initial) {...}
        public void _read(org.omg.CORBA.portable.InputStream i)
            {...}
        public void _write(
            org.omg.CORBA.portable.OutputStream o)
            {...}
        public org.omg.CORBA.TypeCode _type() {...}
    }
}

```

## Sequence

An IDL sequence is mapped to a Java array with the same name. In the mapping, anywhere the sequence type is needed, an array of the mapped type of the sequence element is used.

The holder class for the sequence is also generated. Its name is the sequence's mapped Java classname with `Holder` appended to it as follows:

```

final public class <sequence_class>Holder {
    public <sequence_element_type>[] value;
    public <sequence_class>Holder() {};
    public <sequence_class>Holder(
        <sequence_element_type>[] initial)
    {...};
    public void _read(org.omg.CORBA.portable.InputStream i)
        {...}
    public void _write
        (org.omg.CORBA.portable.OutputStream o)
        {...}
    public org.omg.CORBA.TypeCode _type() {...}
}

```

The following code sample shows the mapping of an IDL sequence to Java.

```

// IDL
typedef sequence<long>UnboundedData;
typedef sequence<long, 42>BoundedData;
// generated Java
final public class UnboundedDataHolder
    implements org.omg.CORBA.portable.Streamable {
    public int[] value;
    public UnboundedDataHolder() {};
    public UnboundedDataHolder(final int[] initial) { ...
};
    public void _read(org.omg.CORBA.portable.InputStream i)
        { ... }
    public void _write
        (org.omg.CORBA.portable.OutputStream o)
        { ... }
    public org.omg.CORBA.TypeCode _type() { ... }
}
final public class BoundedDataHolder

```

```

        implements org.omg.CORBA.portable.Streamable {
    public int[] value;
    public BoundedDataHolder() {};
    public BoundedDataHolder(final int[] initial) { ... };
    public void _read(org.omg.CORBA.portable.InputStream i)
        { ... }
    public void _write
        (org.omg.CORBA.portable.OutputStream o)
        { ... }
    public org.omg.CORBA.TypeCode _type() { ... }
}

```

## Array

An IDL array is mapped the same way as an IDL bounded sequence. In the mapping, anywhere the array type is needed, an array of the mapped type of array element is used. In Java, the natural Java subscripting operator is applied to the mapped array. The length of the array can be made available in Java, by bounding the array with an IDL constant, which will be mapped as per the rules for constants.

The holder class for the array is also generated. Its name is the array's mapped Java classname with `Holder` appended to it as follows:

```

final public class <array_class>Holder
    implements org.omg.CORBA.portable.Streamable {
    public <array_element_type>[] value;
    public <array_class>Holder() {}
    public <array_class>Holder(
        <array_element_type>[] initial) {...}
    public void _read(org.omg.CORBA.portable.InputStream i)
        {...}
    public void _write
        (org.omg.CORBA.portable.OutputStream o)
        {...}
    public org.omg.CORBA.TypeCode _type() {...}
}

```

The following code sample shows the mapping for an array.

```

// IDL
const long ArrayBound = 42;
typedef long larray[ArrayBound];
// generated Java
final public class larrayHolder
    implements org.omg.CORBA.portable.Streamable {
    public int[] value;
    public larrayHolder() {}
    public larrayHolder(int[] initial) {...}
    public void _read(org.omg.CORBA.portable.InputStream i)
        {...}
    public void _write
        (org.omg.CORBA.portable.OutputStream o)
        {...}
    public org.omg.CORBA.TypeCode _type() {...}
}

```

## Interfaces

IDL interfaces are mapped to the two following public Java interfaces:

- Operations interface, which contains only the operations and constants declared in the IDL interfaces.
- CORBA Object declaration that extends all base interface operations, this interface operation, and `org.omg.CORBA.Object`.

An additional “helper” Java class with the suffix `Helper` is appended to the interface name. The Java interface extends the mapped, base `org.omg.CORBA.Object` interface.

The Java interface contains the mapped operation signatures. Methods can be invoked on an object reference to this interface.

The helper class declares a static narrow method that allows an instance of `org.omg.CORBA.Object` to be narrowed to the object reference of a more specific type. The IDL exception `CORBA::BAD_PARAM` is thrown if the narrow fails because the object reference doesn't support the request type. A different system exception is raised to indicate other kinds of errors. Trying to narrow a null will always succeed with a return value of null.

There are no special “nil” object references. Java `null` can be passed freely wherever an object reference is expected.

Attributes are mapped to a pair of Java accessor and modifier methods. These methods have the same name as the IDL attribute and are overloaded. There is no modifier method for IDL “readonly” attributes.

The holder class for the interface is also generated. Its name is the interface's mapped Java classname with `Holder` appended to it as follows:

```
final public class <interface_class>Holder
    implements org.omg.CORBA.portable.Streamable {
    public <interface_class> value;
    public <interface_class>Holder() {}
    public <interface_class>Holder(
        <interface_class> initial) {
        value = initial;
    }
    public void _read(org.omg.CORBA.portable.InputStream i)
        {...}
    public void _write
        (org.omg.CORBA.portable.OutputStream o)
        {...}
    public org.omg.CORBA.TypeCode _type() {...}
}
```

The following code sample shows the mapping of an IDL interface to Java.

```
/* From Example.idl: */

module Example {
    interface Foo {
        long method(in long arg) raises(AnException);
        attribute long assignable;
        readonly attribute long nonassignable;
    };
};

// Generated java
package Example;
public interface Foo extends com.inprise.vbroker.CORBA.Object,
    Example.FooOperations, org.omg.CORBA.portable.IDLEntity {
```

```

}
public interface FooOperations {
    public int method (int arg) throws Example.AnException;
    public int assignable ();
    public void assignable (int assignable);
    public int nonassignable ();
}
public final class FooHelper {
    // ... other standard helper methods
    public static Foo narrow(org.omg.CORBA.Object obj)
        { ... }
    public static Example.Foo bind (org.omg.CORBA.ORB orb,
        java.lang.String name,
        java.lang.String host,
        com.inprise.vbroker.CORBA.BindOptions _options) { ... }
    public static Example.Foo bind (org.omg.CORBA.ORB orb,
        java.lang.String fullPoaName, byte[] oid) { ... }
    public static Example.Foo bind (org.omg.CORBA.ORB orb,
        java.lang.String fullPoaName, byte[] oid,
        java.lang.String host,
        com.inprise.vbroker.CORBA.BindOptions _options) { ... }
    public Foo read (org.omg.CORBA.portable.InputStream in) { ... }
    public void write (org.omg.CORBA.portable.OutputStream out, Foo foo) {
    ... }
    public Foo extract (org.omg.CORBA.Any any) { ... }
    public void insert (org.omg.CORBA.Any any, Foo foo) { ... }
}
public final class FooHolder
    implements org.omg.CORBA.portable.Streamable {
    public Foo value;
    public FooHolder() {}
    public FooHolder(final Foo initial) { ... }
    public void _read(org.omg.CORBA.portable.InputStream i)
        { ... }
    public void _write(org.omg.CORBA.portable.OutputStream o)
        { ... }
    public org.omg.CORBA.TypeCode_type() { ... }
}

```

## Abstract interfaces

An IDL abstract interface is mapped into a single public Java interface with the same name as the IDL interface. The mapping rules are similar to the rules for generating the Java operations interface for a non-abstract IDL interface. However, this interface also serves as the signature interface, and hence extends `org.omg.CORBA.portable.IDLEntity`. The mapped Java interface has the same name as the IDL interface and is also used as the signature type in method declarations when interfaces of the specified types are used in other interfaces. It contains the methods which are the mapped operations signatures.

A holder class is generated as for non-abstract interfaces. See [“Holder classes”](#) for more information.

A helper class is also generated according to the normal rules. See [“Helper classes”](#) for more information.

## Local interfaces

An IDL local interface is mapped similarly to that of a non-local interface except that a local interface is marked by `org.omg.CORBA.LocalInterface`. A local interface may not be marshaled and its implementation must extend a special base `org.omg.CORBA.LocalObject` and implement the generated signature interface. In Java mapping, the `LocalObject` class is used as a base class of implementations of a local interface. Creating an instance of local interface implementation is the same as creating normal Java object; that is using the `new` Java operator.

A holder class is generated as for non-local interfaces. See [“Holder classes”](#) for more information.

A helper class is also generated according to the normal rules. See [“Helper classes”](#) for more information.

The VisiBroker ORB implementation will detect any attempt to marshal local objects and throw a `CORBA::MARSHAL` exception.

## Passing parameters

IDL `in` parameters are mapped to normal Java actual parameters. The results of IDL operations are returned as the result of the corresponding Java method.

IDL `out` and `inout` parameters cannot be mapped directly into the Java parameter passing mechanism. This mapping defines additional holder classes for all the IDL basic and user-defined types which are used to implement these parameter modes in Java. The client supplies an instance of the appropriate holder Java class that is passed (by value) for each IDL `out` or `inout` parameter. The contents of the holder instance (but not the instance itself) are modified by the invocation, and the client uses the (possibly) changed contents after the invocation returns.

This code sample shows the `IN` parameter mapping to Java actual parameters.

```

/* From Example.idl: */
module Example {
    interface Modes {
        long operation(in long inArg, out long outArg, inout
long inoutArg);
    };
};
// Generated Java:
package Example;
public interface Modes extends
com.inprise.vbroker.CORBA.Object,
    Example.ModesOperations,
    org.omg.CORBA.portable.IDLEntity {
}
public interface ModesOperations {
    public int operation (int inArg,
        org.omg.CORBA.IntHolder outArg,
        org.omg.CORBA.IntHolder inoutArg);
}

```

In the above, the result comes back as an ordinary result and the actual `in` parameters only an ordinary value. But for the `out` and `inout` parameters,



an appropriate holder must be constructed. A typical use case might look as follows:

```
// user Java code
// select a target object
Example.Modes target = ...;
// get the in actual value
int inArg = 57;

// prepare to receive out
IntHolder outHolder = new IntHolder();
// set up the in side of the inout
IntHolder inoutHolder = new IntHolder(131);
// make the invocation
int result =target.operation(inArg, outHolder,
inoutHolder);
// use the value of the outHolder
... outHolder.value ...
// use the value of the inoutHolder
... inoutHolder.value ...
```

Before the invocation, the input value of the inout parameter must be set in the holder instance that will be the actual parameter. The inout holder can be filled in either by constructing a new holder from a value, or by assigning it to the value of an existing holder of the appropriate type. After the invocation, the client uses the `outHolder.value` to access the value of the out parameter, and the `inoutHolder.value` to access the output value of the inout parameter. The return result of the IDL operation is available as the result of the invocation.

## Server implementation with inheritance

Using inheritance is the simplest way to implement a server because server objects and object references look the same, behave the same, and can be used in exactly the same contexts. If a server object happens to be in the same process as its client, method invocations are an ordinary Java function call with no transport, indirection, or delegation of any kind.

Each IDL interface is mapped to a Java POA abstract class that implements the Java version of the IDL interface.

### Note

The POA class does not “truly” extend the IDL interface, meaning that POA is not a CORBA object. It is a CORBA servant and it can be used to create a “true” CORBA object. For more information on the POA class, go to the Java API Reference, VisiBroker APIs, `org.omg.PortableServer` package section. For more information about POAs, see [“Using POAs”](#).

User-defined server classes are then linked to the VisiBroker ORB by extending the `<interface>POA` class, as shown in the following code sample.

### Note

The POA class itself is abstract and cannot be instantiated. To instantiate it, your implementation must implement its declared IDL interface operations.

The following code sample shows the Server implementation in Java using inheritance.

```

/* From Bank.idl: */
module Bank {
    interface Account {
    };
};
// Generated java
package Bank;
public abstract class AccountPOA extends
org.omg.PortableServer.Servant implements
    org.omg.CORBA.portable.InvokeHandler,
    Bank.AccountOperations { ... }
// Linking an implementation to the ORB :
public class AccountImpl extends Bank.AccountPOA { ... }

```

## Server implementation with delegation

The use of inheritance to implement a server has one drawback: since the server class extends the POA skeleton class, it cannot use implementation inheritance for other purposes because Java only supports single inheritance. If the server class needs to use the sole inheritance link available for another purpose, the delegation approach must be used.

When server classes are implemented using delegation some extra code is generated.

- Each interface is mapped to a `Tie` class that extends the POA skeleton and provides the delegation code.
- Each interface is also mapped to an `Operations` interface that is used to defined the type of object the `Tie` class is delegating.

The delegated implementation must implement the `Operation` interface and has to be stored in a `Tie` class instance. Storing the instance of the `Operation` interface in the `Tie` object is done through a constructor provided by the `Tie` class. The code sample below shows an example of how delegation is used.

```

/* From Bank.idl: */
module Bank {
    interface AccountManager {
        Account open(in string name);
    };
};
// Generated java
package Bank;
public interface AccountManagerOperations {
    public Example.Account open(java.lang.String name);
}
// Generated java
package Bank;
public class AccountManagerPOATie extends AccountManagerPOA {
    public AccountManagerPOATie (final Bank.AccountManagerOperations
_delegate)
    { ... }
    public AccountManagerPOATie (final Bank.AccountManagerOperations
_delegate,
    final org.omg.PortableServer.POA _poa) { ... }
    public Bank.AccountManagerOperations _delegate () { ... }
    public void _delegate (final Bank.AccountManagerOperations delegate) {
... }
    public org.omg.PortableServer.POA _default_POA () { ... }
}

```

```

    public float open () { ... }
}
// Linking an implementation to the ORB :
classAccountImpl implements AccountManager Operations
public class Server {
    public static main(String args) {
        // ...
        AccountManagerPOATie managerServant = new AccountManagerPOATie(new
AccountManagerImpl());
        // ...
    }
}

```

## Interface scope

OMG IDL to Java mapping specification does not allow declarations to be nested within an interface scope, nor does it allow packages and interfaces to have the same name. Accordingly, interface scope is mapped to a package with the same name with a "Package" suffix.

## Mapping for exceptions

IDL exceptions are mapped very similarly to structs. They are mapped to a Java class that provides instance variables for the fields of the exception and constructors.

CORBA system exceptions are unchecked exceptions. They inherit (indirectly) from `java.lang.RuntimeException`.

User defined exceptions are checked exceptions. They inherit (indirectly) from `java.lang.Exception`.

## User-defined exceptions

User-defined exceptions are mapped to final Java classes that extend `org.omg.CORBA.UserException` and are otherwise mapped just like the IDL `struct` type, including the generation of Helper and Holder classes.

If the exception is defined within a nested IDL scope (essentially within an interface) then its Java class name is defined within a special scope. Otherwise its Java class name is defined within the scope of the Java package that corresponds to the exception's enclosing IDL module.

The following code sample shows the mapping of user-defined exceptions.

```

// IDL
module Example {
    exception AnException {
        string reason;
    };
};
// Generated Java
package Example;
public final class AnException extends
org.omg.CORBA.UserException {
    public java.lang.String extra;
    public AnException () { ... }
    public AnException (java.lang.String extra) { ... }
    public AnException (java.lang.String _reason,
java.lang.String extra) { ... }
}

```

```

    public java.lang.String toString () { ... }
    public boolean equals (java.lang.Object o) { ... }
}
public final class AnExceptionHandler implements
    org.omg.CORBA.portable.Streamable {
    public Example.AnException value;
    public AnExceptionHandler () { }
    public AnExceptionHandler (final Example.AnException
_vis_value) { ... }
    public void _read (final
org.omg.CORBA.portable.InputStream input) { ... }
    public void _write (final
org.omg.CORBA.portable.OutputStream output) { ... }
    public org.omg.CORBA.TypeCode _type () { ... }
}

```

## System exceptions

The standard IDL system exceptions are mapped to final Java classes that extend `org.omg.CORBA.SystemException` and provide access to the IDL major and minor exception code, as well as a string describing the reason for the exception. There are no public constructors for `org.omg.CORBA.SystemException`; only classes that extend it can be instantiated.

The Java class name for each standard IDL exception is the same as its IDL name and is declared to be in the `org.omg.CORBA` package. The default constructor supplies 0 for the minor code, `COMPLETED_NO` for the completion code, and the empty string ("" ) for the reason string. There is also a constructor which takes the reason and uses defaults for the other fields, as well as one which requires all three parameters to be specified.

## Mapping for the Any type

The IDL type `Any` maps to the Java class `org.omg.CORBA.Any`. This class has all the necessary methods to insert and extract instances of predefined types. If the extraction operations have a mismatched type, the `CORBA::BAD_OPERATION` exception is thrown.

In addition, insert and extract methods which take a holder class are defined to provide a high speed interface for use by portable stubs and skeletons. There is an insert and extract method defined for each primitive IDL type as well as a pair for a generic streamable to handle the case of non-primitive IDL types.

The insert operations set the specified value and reset the `Any`'s type if necessary.

Setting the typecode via the `type()` accessor wipes out the value. An attempt to extract before the value is set will result in a `CORBA::BAD_OPERATION` exception being raised. This operation is provided primarily so that the type may be set properly for IDL out parameters.

## Mapping for certain nested types

IDL allows type declarations nested within interfaces. Java does not allow classes to be nested within interfaces. Hence those IDL types that map to

Java classes and that are declared within the scope of an interface must appear in a special “scope” package when mapped to Java.

IDL interfaces that contain these type declarations generate a scope package to contain the mapped Java class declarations. The scope package name is constructed by appending `Package` to the IDL type name.

This code sample shows the mapping for certain nested types.

```
// IDL
module Example {
    interface Foo {
        exception e1 {};
    };
}
// generated Java
package Example.FooPackage;
final public class e1 extends org.omg.CORBA.UserException
{...}
```

## Mapping for Typedef

Java does not have a typedef construct.

### Simple IDL types

IDL types that are mapped to simple Java types may not be subclassed in Java. Therefore, any typedefs that are type declarations for simple types are mapped to the original (mapped type) any where the typedef type appears. For simple types, `Helper` classes are generated for all typedefs.

### Complex IDL types

Typedefs for non arrays and sequences are “unwound” to their original type until a simple IDL type or user-defined IDL type (of the non typedef variety) is encountered.

`Holder` classes are generated for sequence and array typedefs.

The following code sample shows the mapping of a complex idl typedef.

```
// IDL
struct EmpName {
    string firstName;
    string lastName;
};
typedef EmpName EmpRec;
// generated Java
// regular struct mapping for EmpName
// regular helper class mapping for EmpRec
final public class EmpName {
    ...
}
public class EmpRecHelper {
    ...
}
```



# VisiBroker properties

This section describes the VisiBroker properties.

## JAVA RMI over IIOP properties

Property	Default	Description
<code>vbroker.rmi.supportRTSC</code>	<code>false</code>	This property enables or disables the exchange of <code>SendingContextRuntime</code> service contexts between clients and servers when the two are using different (evolved) versions of a class. If the client and server are on different versions of a JDK, the application should make sure that this property is set to <code>true</code> . This value should also be used for cases where VBJ is talking to a foreign ORB. This ensures that the codebase data is exchanged and marshaling/demarshaling of evolved classes can succeed without exceptions.
<code>javax.rmi.CORBA.StubClass</code>	<code>com.inprise.vbroker.rmi.CORBA.StubImpl</code>	Specifies the name of the implementation of the stub base class from which all RMI-IIOP stubs must inherit.
<code>javax.rmi.CORBA.UtilClass</code>	<code>com.inprise.vbroker.rmi.CORBA.UtilImpl</code>	Specifies the name of the implementation of the <code>Utility</code> class that provides methods that can be used by stubs and ties to perform common operations.
<code>javax.rmi.CORBA.PortableRemoteObjectClass</code>	<code>com.inprise.vbroker.rmi.CORBA.PortableRemoteObjectImpl</code>	Specifies that the RMI-IIOP server implementation objects may inherit from <code>javax.rmi.PortableRemoteObject</code> or simply implement an RMI-IIOP remote interface and then use the <code>exportObject</code> method to register themselves as a server object.
<code>java.rmi.server.codebase</code>	<code>&lt;not set&gt;</code>	Specifies where a server can locate unknown classes. Acceptable value is semicolon (;)-separated URLs.
<code>java.rmi.server.useCodebaseOnly</code>	<code>false</code>	Specifies if a server is allowed to locate unknown classes. If set to <code>true</code> , does not allow the server to locate remote classes even if the client sends the location of the remote classes to the server.

---

## Smart Agent properties

The properties in this table are used by the Smart Agent.

Property	Default	Old property	Description
<code>vbroker.agent.addrFile</code>	null	<code>ORBagentAddrFile</code>	Specifies a file that stores the IP address or host name of a host running a Smart Agent.
<code>vbroker.agent.localFile</code>	null	N/A	Specifies which network interface to use on multi-home machines. This used to be the <code>OSAGENT_LOCAL_FILE</code> environment variable.
<code>vbroker.agent.clientHandlerPort</code>	null	N/A	Specifies the port that the Smart Agent uses to verify the existence of a client — in this case, a VisiBroker application. When you use the default value, null, the Smart Agent connects using a random port number.
<code>vbroker.agent.keepAliveTimer</code>	120 seconds	N/A	Smart agent will wake up after this timeout and based on the <code>vbroker.agent.keepAliveThreshold</code> value, will compute whether to do client verification. The logic is if the last received heart beat value is less than current time - ( <code>keepAliveTimer</code> + <code>keepAliveThreshold</code> ), then do client verification. The value of this property should be greater than 1 second and less than 120 seconds. The number of times the client verification is tried can be controlled by <code>vbroker.agent.maxRetries</code> property.
<code>vbroker.agent.keepAliveThreshold</code>	40 seconds	N/A	Refer to documentation on <code>vbroker.agent.keepAliveTimer</code> . This value should be greater than 0.
<code>vbroker.agent.port</code>	14000	<code>ORBagentPort</code>	Specifies the port number that defines a domain within your network. VisiBroker applications and the Smart Agent work together when they have the same port number. This is the same property as the <code>OSAGENT_PORT</code> environment variable.
<code>vbroker.agent.maxRetries</code>	4 times	N/A	The number of times the agent will do client verification on not receiving a heart beat from the client. Values can be 1 to 10.
<code>vbroker.agent.timer</code>	300 seconds	N/A	Smart agent will wake up after this timeout and based on the <code>vbroker.agent.threshold</code> value, will compute whether to do other osagents verification. The logic is if the last received heart beat value is less than current time - ( <code>timer</code> + <code>threshold</code> ), then do osagents verification. The value of this property should be greater than 1 second and less than 300 seconds.  For example,  <pre>\$ osagent -Dvbroker.agent.timer 60 -Dvbroker.agent.threshold 5</pre>
<code>vbroker.agent.threshold</code>	40 seconds	N/A	See <a href="#">vbroker.agent.timer</a> . This value should be greater than 0.



## Smart Agent communication properties

The properties described in the table below are used by the ORB for Smart Agent communication.

Property	Default	Old property	Description
<code>vbroker.agent.keepAliveTimer</code>	120	N/A	The duration in seconds during which the ORB will send keep-alive messages to the Smart Agent (applicable to both clients and servers). Valid values are integers between 1 and 120, inclusive.
<code>vbroker.agent.retryDelay</code>	0 (zero)	N/A	The duration in seconds that the process will pause before trying to reconnect to the Smart Agent in the event of disconnection from the Smart Agent. If the value is -1, the process will exit upon disconnection from the Smart Agent. The default value of 0 (zero) means that reconnection will be made without any pause.
<code>vbroker.agent.addr</code>	null	ORBagentAddr	Specifies the IP address or host name of a host running a Smart Agent. The default value, null, instructs VisiBroker applications to use the value from the <code>OSAGENT_ADDR</code> environment variable. If this <code>OSAGENT_ADDR</code> variable is not set, then it is assumed that the Smart Agent is running on a local host.
<code>vbroker.agent.addrFile</code>	null	ORBagentAddrFile	Specifies a file that stores the IP address or host name of a host running a Smart Agent.
<code>vbroker.agent.debug</code>	false	ORBdebug	When set to <code>true</code> , specifies that the system will display debugging information about communication of VisiBroker applications with the Smart Agent.
<code>vbroker.agent.enableCache</code>	true	ORBagentCache	When set to <code>true</code> , allows VisiBroker applications to cache IOR.
<code>vbroker.agent.enableLocator</code>	true	ORBdisableLocator	When set to <code>false</code> , does not allow VisiBroker applications to communicate with the Smart Agent.
<code>vbroker.agent.port</code>	14000	ORBagentPort	Specifies the port number that defines a domain within your network. VisiBroker applications and the Smart Agent work together when they have the same port number. This is the same property as the <code>OSAGENT_PORT</code> environment variable.
<code>vbroker.agent.failOver</code>	true	ORBagentNoFailOver	When set to <code>true</code> , allows a VisiBroker application to fail over to another Smart Agent.
<code>vbroker.agent.clientPort</code>	0 (zero)	N/A	Lower bound of the range of ports for the ORB to communicate with the OSAgent. Valid values are between 0 to 65535. Default value of 0 (zero) means that a random port will be selected.

## Smart Agent properties

Property	Default	Old property	Description
<code>vbroker.agent.clientPortRange</code>	0 (zero)	N/A	Range of ports within interval [ <code>clientPort</code> , <code>clientPort+clientPortRange</code> ] for the ORB to communicate with the OSAgent. This property is effective only when <code>clientPort</code> is greater than 0 (zero). Valid values are between 0 and 65535.
<code>vbroker.agent.backcompatBind</code>	false	N/A	<p>When set to false, the client ORB will use the <code>hostname</code> parameter passed in from the <code>bind()</code> method when binding to the server.</p> <p>When set to true, it will use the corresponding hostname's IP address when binding to the server.</p> <p>Set to <code>true</code> in order to experience pre-VBJ 8.0 binding behavior.</p>

---

# VisiBroker ORB properties

The following table describes the VisiBroker ORB properties.

Property	Default	Description
<code>vbroker.orb.propOrdering</code>	<code>CMD_PROPS:SYS_PROPS:FILE_PROPS:ORB_PROPS:DEF_PROPS</code>	<p>This property allows the user to override the default precedence of properties set by the ORB's Property Manager. The default precedence from highest to lowest is:</p> <ol style="list-style-type: none"> <li><b>CMD_PROPS:</b> command-line arguments (specified through the first argument of <code>orb.init()</code> call.</li> <li><b>SYS_PROPS:</b> system or JVM properties, including properties specified through <code>-VBJprop</code>, <code>-J</code>, and so forth.</li> <li><b>FILE_PROPS:</b> properties in the file specified by <code>ORBpropStorage</code> property.</li> <li><b>ORB_PROPS:</b> properties set through the second argument of the <code>orb.init()</code> call.</li> <li><b>DEF_PROPS:</b> default ORB properties.</li> </ol>
<code>vbroker.orb.rebindForward</code>	0 (zero)	<p>This value determines the number of times a client will try to connect to a forwarded target. You can use this property when the client cannot communicate with the forwarded target (because of network failure, for example). The default value of 0 (zero) means that the client will keep trying to connect.</p> <p>It determines if the ORB should rebind in the case of a failure to connect during a <code>LOCATION_FORWARD</code>. When the client is forwarded to a new object, an attempt is made to connect to the new (destination) object. If this attempt ends in failure, the ORB transparently connects back to the original object (the source of the forward). This rebind to the source object occurs only if two conditions are fulfilled. The first is that the total number of forwards at this point (without a normal response punctuating them) should not have exceeded the count specified in this property.</p> <p>The second condition is that this failure should not be the second consecutive attempt to connect to the same destination object ending in failure. This prevents the ORB from getting trapped in a loop when a load balancer object repeatedly forwards to the same non-existent object.</p>
<code>vbroker.orb.activationIOR</code>	null	Allows the launched server to easily establish contact with the OAD that launched it.
<code>vbroker.orb.admDir</code>	null	Specifies the administration directory at which various system files are located. This property can be set using the <code>VBROKER_ADM</code> environment variable.
<code>vbroker.orb.enableKeyId</code>	false	When set to <code>true</code> , this property enables the use of key IDs in client requests.
<code>vbroker.orb.enableServerManager</code>	FALSE	When set to <code>TRUE</code> , this property enables Server Manager when the server is started, so that clients can access it.

Property	Default	Description
<code>vbroker.orb.keyIdCacheMax</code>	16384	Specifies maximum size of the object key ID cache in a server.
<code>vbroker.orb.keyIdCacheMin</code>	64	Specifies minimum size of the object key ID cache in a server.
<code>vbroker.orb.initRef</code>	null	Specifies the initial reference.
<code>vbroker.orb.defaultInitRef</code>	null	Specifies the default initial reference.
<code>vbroker.orb.alwaysProxy</code>	false	When set to <code>true</code> , specifies that clients must always connect to the server using the <code>GateKeeper</code> .
<code>vbroker.orb.gatekeeper.ior</code>	null	Forces the client application to connect to the server through the <code>GateKeeper</code> whose IOR is provided.
<code>vbroker.locator.ior</code>	null	Specifies the IOR of the <code>GateKeeper</code> that will be used as proxy to the Smart Agent. If this property is not set, the <code>GateKeeper</code> specified by the <code>vbroker.orb.gatekeeper.ior</code> property is used for this purpose. For more information, see the <b>VisiBroker GateKeeper Guide</b> .
<code>vbroker.orb.exportFirewallPath</code>	false	Forces the server application to include firewall information as part of any servant's IOR which this server exposes (use <code>Firewall::FirewallPolicy</code> in your code to force it selectively per POA).
<code>vbroker.orb.proxyPassthru</code>	false	If set to <code>true</code> , forces <code>PASSTHROUGH</code> firewall mode globally in the application scope (use <code>QoSExt::ProxyModePolicy</code> in your code to force it selectively per object or per ORB).
<code>vbroker.orb.bids.critical</code>	<code>inprocess</code>	The critical bid has highest precedence no matter where it is specified in the bid order. If there are multiple values for critical bids, then their relative importance is decided by the <code>bidOrder</code> property.
<code>vbroker.orb.alwaysSecure</code>	false	When set to <code>true</code> , specifies that clients must always make secure connections to the server.
<code>vbroker.orb.alwaysTunnel</code>	false	When set to <code>true</code> , specifies that clients always make http tunnel (IIOP wrapper) connections to the server.
<code>vbroker.orb.autoLocateStubs</code>	false	Turns on the ability to locate stubs when reading object references. This is done using <code>read_Object</code> , based on the object's repository id instead of either the generic object or the stubs for passed formal class argument.

Property	Default	Description
<code>vbroker.orb.bidOrder</code>	<code>inprocess:liop:ssl: iiop:proxy:hiop:locator</code>	<p>You can specify the relative order of importance for the various transports. Transports are given precedence as follows:</p> <ol style="list-style-type: none"> <li>1 inprocess</li> <li>2 liop</li> <li>3 ssl</li> <li>4 iiop</li> <li>5 proxy</li> <li>6 hiop</li> <li>7 locator</li> </ol> <p>The transports that appear first have higher precedence. For example, if an IOR contains both LIOP and IIOP profiles, the first chance goes to LIOP. Only if the LIOP fails is IIOP used.</p> <p>(The critical bid, specified by the <code>vbroker.orb.bids.critical</code> property, has highest precedence no matter where it is specified in the bid order.)</p>
<code>vbroker.orb.bids.bar</code>	n/a	<p>This property is used to prevent specified bidders from placing bids. For example, setting it to <code>inprocess</code> will disable <code>inprocess</code> bidding. This can be useful in cases when optimized co-located invocations are not required. Only <code>inprocess</code> bidders can be barred.</p>
<code>vbroker.orb.defAddrMode</code>	0 (Key)	<p>The default addressing mode that client VisiBroker ORB uses. If it is set to 0, the addressing mode is <code>Key</code>, if set to 1, the addressing mode is <code>Profile</code>, if set to 2, the addressing mode is <code>IOR</code>.</p>
<code>vbroker.orb.bufferCacheTimeout</code>	6000	<p>Specifies the time in which a message chunk has been cached before it is discarded.</p>
<code>vbroker.orb.bufferDebug</code>	false	<p>When set to <code>true</code>, this property allows the internal buffer manager to display debugging information.</p>
<code>vbroker.orb.corbaloc.resolveHosts</code>	false	<p>When this property is set to <code>true</code> the ORB will try to resolve the hostnames specified in the <code>corbaloc</code> URL. When <code>false</code> no address resolution will take place.</p>
<code>vbroker.orb.debug</code>	false	<p>When set to <code>true</code>, allows the ORB to display debugging information.</p>
<code>vbroker.orb.dynamicLibs</code>	null	<p>Specifies a list of available services used by the VisiBroker ORB. Each service is separated by a comma.</p>
<code>vbroker.orb.embedCodeset</code>	true	<p>When an IOR is created, the VisiBroker ORB embeds the codeset components into the IOR. This may produce problems with some non-compliant ORBs. By turning off the <code>embedCodeset</code> property, you instruct the VisiBroker ORB not to embed codesets in IORs. When set to <code>false</code>, specifies that character and wide character conversions between the client and the server are not to be negotiated.</p>

Property	Default	Description
<code>vbroker.orb.enableVB4backcompat</code>	<code>false</code>	This property enables work-arounds to deal with behavior that is not GIOP 1.2-compliant in VisiBroker 4.0 and 4.1. Any VisiBroker client running on VisiBroker 4.1.1 or a release previous to 4.1.1 is affected, especially if GateKeeper is involved. To work with a Visibroker 4.0 or 4.1 client, this flag needs to be set to <code>true</code> . This is a server-side only flag. There is no corresponding flag on the client side.
<code>vbroker.orb.backCompatAlign</code>	<code>false</code>	Use this property when the IDL contains a <code>longlong</code> as a parameter or as a return value. To be backward-compatible with VisiBroker 4.1.1 or earlier versions, set this property to <code>true</code> .
<code>vbroker.orb.enableBiDir</code>	<code>none</code>	You can selectively make bidirectional connections. If the client defines <code>vbroker.orb.enableBiDir=client</code> and the server defines <code>vbroker.orb.enableBiDir=server</code> the value of <code>vbroker.orb.enableBiDir</code> at the GateKeeper determines the state of the connection. Values of this property are: <code>server</code> , <code>client</code> , <code>both</code> or <code>none</code> . For more information, see <a href="#">“Properties that support bidirectional communication”</a> and also <i>Callback with GateKeeper’s bidirectional support</i> in the <b>VisiBroker GateKeeper Guide</b> .
<code>vbroker.orb.enableNullString</code>	<code>false</code>	If set to <code>TRUE</code> , enables marshaling of null strings.
<code>vbroker.orb.fragmentSize</code>	<code>0 (zero)</code>	Specifies the GIOP message fragment size. It must be a multiple of GIOP message chunk size ( <code>vbroker.orb.streamChunkSize</code> ). Assigning a <code>0 (zero)</code> to this property will eventually turn off fragmentation.
<code>vbroker.orb.streamChunkSize</code>	<code>4096</code>	Specifies the GIOP message chunk size. It must be a power of 2.
<code>vbroker.orb.gcTimeout</code>	<code>30</code>	Specifies the time in seconds that must pass before important resources that are not used are cleared.
<code>vbroker.orb.logger.appName</code>	<code>VBJ-Application</code>	Specifies the application name that appears in the log.
<code>vbroker.orb.logger.catalog</code>	<code>com.inprise.vbroker.Logging.ORBMsgs</code>	Specifies the message catalog of messages used by the ORB when logging is enabled.
<code>vbroker.orb.logger.output</code>	<code>stdout</code>	Specifies the output of the logger. It can be the standard output or a file name.

Property	Default	Description
<code>vbroker.orb.logLevel</code>	<code>emerg</code>	<p><b>Note:</b> This property is deprecated. See <a href="#">“Debug Logging Properties”</a> for recommended properties to use in its place.</p> <p>Specifies the logging level of message that will be logged. The default value, <code>emerg</code>, means that the system logs messages when the system is unusable, or in a panic condition. Acceptable values are:</p> <ul style="list-style-type: none"> <li>• <code>emerg</code> (0): indicates some panic condition.</li> <li>• <code>alert</code> (1): a condition that requires user attention—for example, if security has been disabled.</li> <li>• <code>crit</code> (2): critical conditions, such as a device error.</li> <li>• <code>err</code> (3): error conditions.</li> <li>• <code>warning</code> (4): warning conditions—these may accompany some troubleshooting advice.</li> <li>• <code>notice</code> (5): conditions that are not errors but may require some attention, such as upon the opening of a connection.</li> <li>• <code>info</code> (6): informational, such as binding in progress.</li> <li>• <code>debug</code> (7): debug conditions understood by developers.</li> </ul>
<code>vbroker.orb.sendLocate</code>	<code>false</code>	<p>This property takes one of the following values: <code>true</code>, <code>false</code>, <code>onbind</code>, or <code>always</code>. When set to <code>true</code>, it forces the system to send a locate request before making invocations on an IIOP 1.2 target. When set to <code>onbind</code>, causes a locate request message to be sent when a connection is opened for the purpose of gauging if the peer is GIOP aware. The value <code>always</code> instructs the ORB to perform both tasks—sending the locate request before invocations and upon opening the connection.</p>
<code>vbroker.orb.shutdownTimeout</code>	0 (zero)	<p>Allows an application to set a timeout for the <code>ORB.shutdown</code> operation in seconds. This property is useful in cases when <code>ORB.shutdown</code> does not finish for a long time. The process will get terminated if the shutdown does not finish and the timeout expires. The default value of 0 (zero) means that process will never get terminated.</p>

Property	Default	Description
<code>vbroker.orb.systemLibs.applet</code>	<code>com.inprise.vbroker.IIOP.Init, com.inprise.vbroker.LIOP.Init, com.inprise.vbroker.qos.Init, com.inprise.vbroker.URLNaming.Init, com.inprise.vbroker.HIOP.Init, com.inprise.vbroker.firewall.Init, com.inprise.vbroker.dynamic.Init, com.inprise.vbroker.naming.Init, com.inprise.vbroker.IOP.Init, com.inprise.vbroker.CONV_FRAME.Init, com.inprise.vbroker.rmi.CORBA.Init, com.inprise.vbroker.PortableInterceptor.Init, com.borland.vbroker.notify.Init, com.borland.vbroker.CosTime.Init</code>	Provides a list of system libraries loaded in applet.
<code>vbroker.orb.systemLibs.application</code>	<code>com.inprise.vbroker.IIOP.Init, com.inprise.vbroker.LIOP.Init, com.inprise.vbroker.qos.Init, com.inprise.vbroker.ds.Init, com.inprise.vbroker.URLNaming.Init, com.inprise.vbroker.dynamic.Init, com.inprise.vbroker.ir.Init, com.inprise.vbroker.naming.Init, com.inprise.vbroker.ServerManager.Init, com.inprise.vbroker.IOP.Init, com.inprise.vbroker.CONV_FRAME.Init, com.inprise.vbroker.rmi.CORBA.Init, com.inprise.vbroker.PortableInterceptor.Init, com.borland.vbroker.notify.Init, com.borland.vbroker.CosTime.Init</code>	Provides a list of system libraries loaded in application.
<code>vbroker.orb.tcIndirection</code>	<code>true</code>	Specifies that indirection be turned off when writing the typecodes. May be necessary when interoperating with ORBs from other vendors. When set to <code>false</code> , it is not possible to marshal recursive typecodes.



Property	Default	Description
<code>vbroker.orb.warn</code>	0	Specifies a value of 0, 1, or 2 which indicates the level of warning messages to be printed.
<code>vbroker.orb.procId</code>	0	Specifies the process ID of the server.
<code>vbroker.orb.usingPoll</code>	true	On UNIX platforms, the ORB uses the system calls <code>select()</code> or <code>poll()</code> for I/O multiplexing based on the value of this property. If the value is true, <code>poll()</code> is used. Otherwise, <code>select()</code> is used. True is the default value.
<code>vbroker.orb.ncsc</code>	none	If set to UTF8, the ORB will use UTF-8 as the native code set for the IDL char type, instead of ISO-LATIN-1. If the property is omitted then ISO-LATIN-1 will be used as the native code set.
<code>vbroker.orb.serverSendTimeout</code>	0	Timeout in seconds for the Server side ORB to send a message to a Client.  Default value 0 means no timeout.  If the write operation is blocked for more then the <code>serverSendTimeout</code> limit, it will timeout and close the connection.
<code>vbroker.orb.invalidLicenseExit</code>	true	By default, when a license check fails in an application, the application will be aborted.  If set to false, a <code>CORBA:NO_PERMISSION</code> exception is just thrown and application will not be aborted.  This property is useful when using the ORB inside a WebLogic Server process. When the license check fails, the WebLogic process will not be aborted.
<code>vbroker.orb.tcpTimeout</code>	0	<b>Note:</b> This property is deprecated due to the limitation of the design that set the value at the socket read level. It is not compliant to OMG CORBA Messaging specification. For more information, refer to the QoS relative roundtrip and request properties or policies which are well implemented and more accurate.  The default zero means no timeout is enabled. This property will associate a timeout with all socket-read at the client-side ORB. The specified timeout value is in milliseconds that is passed to set <code>SoTimeout()</code> in <code>java.net.Socket</code> .  <b>Note:</b> The setting of this property will disable the QoS relative roundtrip and request timeout policies.  This property is an ORB level property, so there is no way to obtain object level or thread level granularity unlike the QoS policies. If more than one CORBA request is sent to the same connection by multiple threads concurrently, the actual time spent in reading data from socket may be greater than the timeout value set per invocation.

Property	Default	Description
<code>vbroker.orb.mtmPerCall</code>	<code>true</code>	If true, any thread calling <code>ORB::perform_work()</code> can perform the request. If false, the thread that calls <code>ORB::perform_work()</code> the first time becomes the "main thread" throughout the lifetime of the ORB. The call to <code>ORB::perform_work()</code> from a thread other than the "main thread" does nothing.
<code>vbroker.orb.serverDelayClose</code>	<code>false</code>	By default, the Server ORB closes the socket immediately after sending the <code>CloseConnection</code> message to the client. When this property is set to true, the Server will continue to read data from the socket after sending the <code>CloseConnection</code> message until the Client closes its socket. Only then will the Server close its socket. Note that all requests received after the <code>CloseConnection</code> message is sent will be discarded.
<code>vbroker.orb.serverDelayCloseTimeout</code>	30	If <code>vbroker.orb.serverDelayClose=true</code> is set and the Client does not respond to the <code>CloseConnection</code> message, the Server can set this property to limit the time the Server waits for the Client to close its socket. This can prevent the Server from hogging socket resources due to unresponsive clients. The value is in seconds and the default value is 30.
<code>vbroker.orb.serverRecvTimeout</code>	0	Timeout in seconds for the server-side ORB to receive a message from a client. Default value of 0 means no timeout. This property is only applicable if NIO Socket is configured at the server-side.

## POA properties

Property	Default	Description
<code>vbroker.poa.manager.threadMin</code>	0	Controls the minimum number of threads in the auxiliary thread pool used in POA (for instance, for etherealization of objects).
<code>vbroker.poa.manager.threadMax</code>	0	Controls the maximum number of threads in the auxiliary thread pool used in POA.

Property	Default	Description
<code>vbroker.poa.manager.threadMaxIdle</code>	300	Controls the idle timeout for threads in the auxiliary thread pool used in POA.
<code>vbroker.poa.logLevel</code>	emerg	<p><b>Note:</b> This property is deprecated. See <a href="#">“Debug Logging Properties”</a> for recommended properties to use in its place.</p> <p>Specifies the logging level of messages to be logged. The default value, <code>emerg</code>, means that messages are logged when the system is unusable or during a panic condition.</p> <p>Acceptable values are:</p> <ul style="list-style-type: none"> <li>• <code>emerg</code> (0): indicates some panic condition.</li> <li>• <code>alert</code> (1): a condition that requires user attention—for example, if security has been disabled.</li> <li>• <code>crit</code> (2): critical conditions, such as a device error.</li> <li>• <code>err</code> (3): error conditions.</li> <li>• <code>warning</code> (4): warning conditions—these may accompany some troubleshooting advice.</li> <li>• <code>notice</code> (5): conditions that are not errors but may require some attention, such as upon the opening of a connection.</li> <li>• <code>info</code> (6): informational, such as binding in progress.</li> <li>• <code>debug</code> (7): debug conditions understood by developers.</li> </ul>

## Server Manager properties

This table lists the Server Manager properties.

Property	Default	Description
<code>vbroker.serverManager.name</code>	null	Specifies the name of the Server Manager.
<code>vbroker.serverManager.enableOperations</code>	true	When set to <code>true</code> , enables operations, exposed by the Server Manager, to be invoked.
<code>vbroker.serverManager.enable SetProperty</code>	true	When set to <code>true</code> , enables properties, exposed by the Server Manager, to be changed.

## Properties showing run-time status of Server

The following properties show the run-time state of the Server which can be queried through the Server Manager’s container. These are all read-only.

## Properties related to Server-side resource usage

Property	Description
<code>vbroker.se.&lt;SE_name&gt;.scm.&lt;SCM_name&gt;.manager.inUseConnections</code>	The number of incoming connections for which there are requests executing in the ORB.
<code>vbroker.se.&lt;SE_name&gt;.scm.&lt;SCM_name&gt;.manager.idleConnections</code>	The number of incoming connections for which there are no requests currently being executed in the ORB.
<code>vbroker.se.&lt;SE_name&gt;.scm.&lt;SCM_name&gt;.manager.idledTimeoutConnections</code>	The number of connections which have been idle past their idle timeout setting but have yet to be closed (due to garbage collection restrictions, for example).
<code>vbroker.se.&lt;SE_name&gt;.scm.&lt;SCM_name&gt;.dispatcher.inUseThreads</code>	The number of threads currently executing requests within the dispatcher.
<code>vbroker.se.&lt;SE_name&gt;.scm.&lt;SCM_name&gt;.dispatcher.idleThreads</code>	The number of threads which are currently idle waiting for work to be assigned.

## Properties related to Client-side resource usage

Property	Description
<code>vbroker.ce.&lt;CE_name&gt;.ccm.activeConnections</code>	The number of connections in the active pool; that is, object references are using these connections.
<code>vbroker.ce.&lt;CE_name&gt;.ccm.cachedConnections</code>	The number of connections in the cache pool; no object references are using these connections.
<code>vbroker.ce.&lt;CE_name&gt;.ccm.inUseConnections</code>	The number of outgoing connections with pending requests.
<code>vbroker.ce.&lt;CE_name&gt;.ccm.idleConnections</code>	The number of outgoing connections with no pending requests.
<code>vbroker.ce.&lt;CE_name&gt;.ccm.idledTimeoutConnections</code>	The number of idle connections which have idled past their timeout setting, but have not been closed.

## Properties related to the Smart Agent (osagent)

Property	Description
<code>vbroker.agent.currentAgentIP</code>	The IP address of the current ORB's Smart Agent (Smart Agent).
<code>vbroker.agent.currentAgentClientPort</code>	The port of the Smart Agent to which the ORB is sending requests.

## Location Service properties

The following table lists the Location Service properties.

Property	Default	Description
<code>vbroker.locationservice.debug</code>	<code>false</code>	When set to <code>true</code> , allows the Location Service to display debugging information.
<code>vbroker.locationservice.verify</code>	<code>false</code>	When set to <code>true</code> , allows the Location Service to check for the existence of an object referred by an object reference sent from the Smart Agent. Only objects registered by <code>BY_INSTANCE</code> are verified for existence. Objects that are either registered with <code>OAD</code> , or those registered <code>BY_POA</code> policy are not verified for existence.
<code>vbroker.locationservice.timeout</code>	<code>1</code>	Specifies the connect/receive/send timeout, in seconds, when trying to interact with the Location Service.

## Event Service properties

The following table lists the Event Service properties.

Property	Default	Description
<code>vbroker.events.maxQueueLength</code>	<code>100</code>	Specifies the number of messages to be queued for slow consumers.
<code>vbroker.events.factory</code>	<code>false</code>	When set to <code>true</code> , allows the event channel factory to be instantiated, instead of an event channel.
<code>vbroker.events.debug</code>	<code>false</code>	When set to <code>true</code> , allows output of debugging information.
<code>vbroker.events.interactive</code>	<code>false</code>	When set to <code>true</code> , allows the event channel to be executed in a console-driven, interactive mode.

# Naming Service (VisiNaming) properties

The following tables list the VisiNaming Service properties.

Property	Default	Description
<code>vbroker.naming.adminPwd</code>	<code>inprise</code>	Password required by administrative VisiBroker naming service operations.
<code>vbroker.naming.enableSlave</code>	<code>0</code>	If 1, enables master/slave naming services configuration. See the <a href="#">“VisiNaming Service Clusters for Failover and Load Balancing”</a> section for information about configuring master/slave naming services.
<code>vbroker.naming.factoryIorFile</code>	N/A	When this property is specified with a value specifying a file name, the Naming Service will store the IOR of context factory in that file. The IOR file can then be used by the <code>nsutil</code> utility to shutdown the Naming Service remotely.
<code>vbroker.naming.iorFile</code>	<code>ns.ior</code>	This property specifies the full path name for storing the naming service IOR. If you do not set this property, the naming service will try to output its IOR into a file named <code>ns.ior</code> in the current directory. The naming service silently ignores file access permission exceptions when it tries to output its IOR.
<code>vbroker.naming.logUpdate</code>	<code>false</code>	<p>This property allows special logging for all of the update operations on the <code>CosNaming::NamingContext</code>, <code>CosNamingExt::Cluster</code>, and <code>CosNamingExt::ClusterManager</code> interfaces.</p> <p>The <code>CosNaming::NamingContext</code> interface operations for which this property is effective are:</p> <pre>bind, bind_context, bind_new_context, destroy, rebind, rebind_context, unbind</pre> <p>The <code>CosNamingExt::Cluster</code> interface operations for which this property is effective are:</p> <pre>bind, rebind, unbind, destroy</pre> <p>The <code>CosNamingExt::ClusterManager</code> interface operation for which this property is effective is:</p> <pre>create_cluster</pre> <p>When this property value is set to <code>true</code> and any of the above methods is invoked, the following log message is printed (the output shows a bind operation being executed):</p> <pre>00000007,5/26/04 10:11 AM,127.0.0.1,00000000, VBJ-Application,VBJ ThreadPool Worker,INFO,  OPERATION NAME : bind CLIENT END POINT : Connection[socket=Socket [addr=/127.0.0.1, port=2026, localport=1993]] PARAMETER 0 : [(Tom.LoanAccount)] PARAMETER 1 : Stub[repository_id=IDL:Bank/ LoanAccount:1.0, key=TransientId[poaName=/, id={4 bytes: (0)(0)(0)(0)},sec=505,usec=990917734, key_string=%00VB%01%00%00%00%02/ %00%20%20%00%00%00% 04%00%00%00%00%00%00%01%f9;%104f],codebase=null]</pre>
<code>vbroker.se.iiop_tp.scm.iiop_tp.listener.deferAccept</code>	<code>false</code>	<p>Causes the Naming Service to discard incoming requests while starting up. Though the property form is generic, it should only be used with Naming Service. Use with any other service or application can cause unknown behavior.</p> <p>This property only works when:</p> <ol style="list-style-type: none"> <li>1 Listener port is set.</li> <li>2 Listener port range is not specified.</li> </ol>
<code>vbroker.se.iiop_tp.scm.ssl.listener.deferAccept</code>		

## Properties relating to object clustering

For more information see the [Object Clusters](#) section.

Property	Default	Description
<code>vbroker.naming.enableClusterFailover</code>	<code>true</code>	When set to <code>true</code> , it specifies that an interceptor be installed to handle fail-over for objects that were retrieved from the VisiNaming Service. In case of an object failure, an attempt is made to transparently reconnect to another object from the same cluster as the original.
<code>vbroker.naming.propBindOn</code>	<code>0</code>	If <code>1</code> , the implicit clustering feature is turned on.
<code>vbroker.naming.smrr.pruneStaleRef</code>	<code>1</code>	This property is relevant when the name service cluster uses the Smart Round Robin criterion. When this property is set to <code>1</code> , a stale object reference that was previously bound to a cluster with the Smart Round Robin criterion will be removed from the bindings when the name service discovers it. If this property is set to <code>0</code> , stale object reference bindings under the cluster are not eliminated. However, a cluster with Smart Round Robin criterion will always return an active object reference upon a <code>resolve()</code> or <code>select()</code> call if such an object binding exists, regardless of the value of the <code>vbroker.naming.smrr.pruneStaleRef</code> property. By default, the implicit clustering in the name service uses the Smart Round Robin criterion with the property value set to <code>1</code> . If set to <code>2</code> , this property disables the clearing of stale references completely, and the responsibility of cleaning up the bindings belongs to the application, rather than to VisiNaming.

## VisiNaming service cluster related properties

For more information see “[VisiNaming Service Clusters for Failover and Load Balancing](#)”.

Property	Default	Description
<code>vbroker.naming.enableSlave</code>	<code>0</code>	See “ <a href="#">VisiNaming Service properties</a> ”.
<code>vbroker.naming.slaveMode</code>	No default. Can be set to: <code>cluster</code> or <code>slave</code> .	This property is used to configure VisiNaming Service instances in the cluster mode or in the master/slave mode. The <code>vbroker.naming.enableSlave</code> property must be set to <code>1</code> for this property to take effect.  Set this property to <code>cluster</code> to configure VisiNaming Service instances in the cluster mode. VisiNaming Service clients will then be load balanced among the VisiNaming Service instances that comprise the cluster. Client failover across these instances are enabled.  Set this property to <code>slave</code> to configure VisiNaming Service instances in the master/slave mode. VisiNaming Service clients will always be bound to the master server if the master is running but failover to the slave server when the master server is down.
<code>vbroker.naming.serverClusterName</code>	<code>null</code>	This property specifies the name of a VisiNaming Service cluster. Multiple VisiNaming Service instances belong to a particular cluster (for example, <code>clusterXYZ</code> ) when they are configured with the cluster name using this property.

Property	Default	Description
<code>vbroker.naming.serverNames</code>	null	<p>This property specifies the factory names of the VisiNaming Service instances that belong to a cluster. Each VisiNaming Service instance within the cluster should be configured using this property to be aware of all the instances that constitute the cluster. Each name in the list must be unique. This property supports the format:</p> <pre>vbroker.naming.serverNames=   Server1:Server2:Server3</pre> <p>See the related property, <code>vbroker.naming.serverAddresses</code>.</p>
<code>vbroker.naming.serverAddresses</code>	null	<p>This property specifies the host and listening port for the VisiNaming Service instances that comprise a VisiNaming Service cluster. The order of VisiNaming Service instances in this list must be identical to that of the related property <code>vbroker.naming.serverNames</code>, which specifies the names of the VisiNaming Service instances that comprise a VisiNaming Service Cluster. This property supports the format:</p> <pre>vbroker.naming.serverAddresses=host1:   port1;host2:port2;host3:port3</pre>
<code>vbroker.naming.anyServiceOrder</code> (To be set on VisiNaming Service clients)	false	<p>This property must be set to <code>true</code> on the VisiNaming Service client to utilize the load balancing and failover features available when VisiNaming Service instances are configured in the VisiNaming Service cluster mode. The following is an example of how to use this property:</p> <pre>vbj -Dvbroker.naming.anyServiceOrder=true Client</pre>

## Pluggable Backing Store Properties

The following tables show property information for the VisiNaming service pluggable backing store types.

### Default properties common to all adapters

Property	Default	Description
<code>vbroker.naming.backingStoreType</code>	InMemory	Specifies the naming service adapter type to use. This property specifies which type of backing store you want the VisiNaming Service to use. The valid options are: InMemory, JDBC, Dx, JNDI. The default is InMemory.
<code>vbroker.naming.cacheOn</code>	0	Specifies whether to use the Naming Service cache. A value of 1 (one) enables caching.
<code>vbroker.naming.cache.connectString</code>	N/A	<p>This property is required when the Naming Service cache is enabled (<code>vbroker.naming.cacheOn=1</code>) and the Naming Service instances are configured in Cluster or Master/Slave mode. It helps locate an Event Service instance in the format <code>&lt;hostname&gt;:&lt;port&gt;</code>. For example:</p> <pre>vbroker.naming.cache.connectString=   127.0.0.1:14500</pre> <p>See <a href="#">“Caching facility”</a> for details about enabling the caching facility and setting the appropriate properties.</p>

## Naming Service (VisiNaming) properties

Property	Default	Description
<code>vbroker.naming.cache.size</code>	2000	This property specifies the size of the Naming Service cache. Higher values will mean caching of more data at the cost of increased memory consumption.
<code>vbroker.naming.cache.timeout</code>	0 (no limit)	This property specifies the time, in seconds, since the last time a piece of data was accessed, after which the data in the cache will be purged in order to free memory. The cached entries are deleted in LRU (Least Recently Used) order.

## JDBC Adapter properties

Property	Default	Description
<code>vbroker.naming.jdbcDriver</code>	<code>com.borland.datastore.jdbc.DataStoreDriver</code>	<p>This property specifies the JDBC driver that is needed to access the database used as your backing store. The VisiNaming Service loads the appropriate JDBC driver specified. Valid values are:</p> <ul style="list-style-type: none"><li><code>com.borland.datastore.jdbc.DataStoreDriver</code>—J DataStore driver</li><li><code>com.sybase.jdbc.SybDriver</code>—Sybase driver</li><li><code>oracle.jdbc.driver.OracleDriver</code>—Oracle driver</li><li><code>interbase.interclient.Driver</code>—Interbase driver</li><li><code>weblogic.jdbc.mssqlserver4.Driver</code>—WebLogic MS SQLServer Driver</li><li><code>COM.ibm.db2.jdbc.app.DB2Driver</code>—IBM DB2 Driver</li></ul>
<code>vbroker.naming.resolveAutoCommit</code>	True	<p>Sets Auto Commit on the JDBC connection when doing a "resolve" operation.</p> <p>When this property is set to <code>false</code>, the resolve operation will use the same transaction pattern as used in other similar methods such as <code>bind</code>, <code>rebind</code> and so on. If it is set to <code>true</code>, there will be better performance for the "resolve" operation.</p> <p>For VisiNaming using JDS HA failover configuration, set this property to <code>false</code>.</p>
<code>vbroker.naming.loginName</code>	VisiNaming	The login name associated with the database.
<code>vbroker.naming.loginPwd</code>	VisiNaming	The login password associated with the database.
<code>vbroker.naming.poolSize</code>	5	This property specifies the number of database connections in your connection pool when using the JDBC Adapter as your backing store.



Property	Default	Description
vbroker.naming.url	jdbc:borland: dslocal:rootDB. jds	This property specifies the location of the database which you want the Naming Service to access. The setting is dependent upon the database in use. Acceptable values are: <ul style="list-style-type: none"> <li>jdbc:borland:dslocal:&lt;db-name&gt;—JDataStore UTL</li> <li>jdbc:sybase:Tds:&lt;host-name&gt;:&lt;port-number&gt;/&lt;db-name&gt;—Sybase URL</li> <li>jdbc:oracle:thin@&lt;host-name&gt;:&lt;port-number&gt;:&lt;sid&gt;—Oracle URL</li> <li>jdbc:interbase://&lt;server-name&gt;/&lt;full-db-path&gt;—Interbase URL</li> <li>jdbc:weblogic:mssqlserver4:&lt;db-name&gt;@&lt;host-name&gt;:&lt;port-number&gt;—WebLogic MS SQLSever URL</li> <li>jdbc:db2:&lt;db-name&gt;—IBM DB2 URL</li> <li>&lt;full-path-JDataStore-db&gt;—DataExpress URL for the native driver</li> </ul>
vbroker.naming.minReconInterval	30	This property sets the Naming Service's database reconnection interval time, in seconds. The default value is 30. The Naming Service will ignore the reconnection request and throw a <code>CannotProceed</code> exception if the time interval between this request and the last reconnection time is less than the <code>vset</code> value. Valid values for this property are non-negative integers. If set to 0, the Naming Service will try to reconnect to the database for every request.

## DataExpress Adapter properties

The following table describes the DataExpress Adapter properties:

Property	Description
vbroker.naming.backingStoreType	This property should be set to <code>Dx</code> .
vbroker.naming.loginName	This property is the login name associated with the database. The default is <code>VisiNaming</code> .
vbroker.naming.loginPwd	This property is the login password associated with the database. The default value is <code>VisiNaming</code> .
vbroker.naming.url	This property specifies the location of the database.

## JNDI adapter properties

The following is an example of settings that can appear in the configuration file for a JNDI adapter:

Setting	Description
vbroker.naming.backingStoreType=JNDI	This setting specifies the backing store type which is JNDI for the JNDI adapter.
vbroker.naming.loginName=<user_name>	The user login name on the JNDI backing server.
vbroker.naming.loginPwd=<password>	The password for the JNDI backing server user.
vbroker.naming.jndiInitialFactory=com.sun.jndi.ldap.LdapCtxFactory	This setting specifies the JNDI initial factory.
vbroker.naming.jndiProviderURL=ldap://<hostname>:389/<initial root context>	This setting specifies the JNDI provider URL.
vbroker.naming.jndiAuthentication=simple	This setting specifies the JNDI authentication type supported by the JNDI backing server.

## VisiNaming Service Security-related properties

Property	Value	Default	Description
<code>vbroker.naming.security.disable</code>	boolean	<code>true</code>	This property indicates whether the security service is disabled.
<code>vbroker.naming.security.authDomain</code>	string	""	This property indicates the authorization domain name to be used for the naming service method access authorization.
<code>vbroker.naming.security.transport</code>	int	3	This property indicates what transport the Naming Service will use. The available values are:  <pre>ServerQoPPolicy.SECURE_ONLY=1 ServerQoPPolicy.CLEAR_ONLY=0 ServerQoPPolicy.ALL=3</pre>
<code>vbroker.naming.security.requireAuthentication</code>	boolean	<code>false</code>	This property indicates whether naming client authentication is required. However, when the <code>vbroker.naming.security.disable</code> property is set to <code>true</code> , no client authentication will be performed regardless of the value of this <code>requireAuthentication</code> property.
<code>vbroker.naming.security.enableAuthorization</code>	boolean	<code>false</code>	This property indicates whether method access authorization is enabled.
<code>vbroker.naming.security.requiredRolesFile</code>	string	<code>null</code>	This property points to the file containing the required roles that are necessary for invocation of each method in the protected object types. For more information see <a href="#">"Method Level Authorization"</a> .

## OAD properties

This following table lists the configurable Object Activation Daemon (OAD) properties. See ["Using the Object Activation Daemon \(OAD\)"](#) for details about using the OAD.

Property	Default	Description
<code>vbroker.oad.spawnTimeOut</code>	20	After the OAD spawns an executable, specifies how long, in seconds, the system will wait to receive a callback from the desired object before throwing a <code>NO_RESPONSE</code> exception.
<code>vbroker.oad.verbose</code>	<code>false</code>	Allows the OAD to print detailed information about its operations.
<code>vbroker.oad.readOnly</code>	<code>false</code>	When set to true, does not allow you to register, unregister, or change the OAD implementation.
<code>vbroker.oad.iorFile</code>	<code>Oadj.ior</code>	Specifies the filename for the OAD's stringified IOR.
<code>vbroker.oad.quoteSpaces</code>	<code>false</code>	Specifies whether to quote a command.
<code>vbroker.oad.killOnUnregister</code>	<code>false</code>	Specifies whether to kill spawned server processes, once they are unregistered.
<code>vbroker.oad.verifyRegistration</code>	<code>false</code>	Specifies whether to verify the object registration.
<code>vbroker.oad.locateAlways</code>	<code>false</code>	This property is used as an environment setting when registering a Visibroker Java server with the <code>oadutil</code> command. Set this property to <code>true</code> , so that the client can locate the VisiBroker server that is started by OAD. See <a href="#">"Registering objects with oadutil"</a> for details.

This table lists the OAD properties that cannot be overridden in a property file. They can however be overridden with environment variables or from the command line.

Property	Default	Description
<code>vbroker.oad.implName</code>	<code>impl_rep</code>	Specifies the filename for the implementation repository.
<code>vbroker.oad.implPath</code>	<code>null</code>	Specifies the directory where the implementation repository is stored.
<code>vbroker.oad.path</code>	<code>null</code>	Specifies the directory for the OAD.
<code>vbroker.oad.systemRoot</code>	<code>null</code>	Specifies the root directory.
<code>vbroker.oad.windir</code>	<code>null</code>	Specifies the Windows directory.
<code>vbroker.oad.vbj</code>	<code>vbj</code>	Specifies the VisiBroker for Java directory.

## Interface Repository properties

The following table lists the Interface Repository (IR) properties.

Property	Default	Description
<code>vbroker.ir.debug</code>	<code>false</code>	When set to true, allows the IR resolver to display debugging information.
<code>vbroker.ir.ior</code>	<code>null</code>	When the <code>vbroker.ir.name</code> property is set to the default value, <code>null</code> , the VisiBroker ORB will try to use this property to locate the IR.
<code>vbroker.ir.name</code>	<code>null</code>	Specifies the name that is used by the VisiBroker ORB to locate the IR.

## Client-side IIOP connection properties

The table below lists the VisiBroker for Java Client-side IIOP Connection properties.

Property	Default	Description
<code>vbroker.ce.iiop.ccm.connectionCacheMax</code>	<code>5</code>	Specifies the maximum number of cached connections for a client. The connection is cached when a client releases it. Therefore, the next time a client needs a new connection, it first tries to retrieve one from the cache, instead of just creating a new one.
<code>vbroker.ce.iiop.ccm.connectionMax</code>	<code>0</code>	Specifies the maximum number of total connections for a client. This is equal to the number of active connections plus cached connections. The default value of zero specifies that the client will not try to close any of the old active or cached connections.
<code>vbroker.ce.iiop.ccm.connectionMaxIdle</code>	<code>0</code>	Specifies the time, in seconds, that the client uses to determine if a cached connection should be closed. If a cached connection has been idle longer than this time, then the client closes the connection.
<code>vbroker.ce.iiop.ccm.type</code>	<code>Pool</code>	Specifies the type of client connection management used by a client. The value <code>Pool</code> means connection pool. This is currently the only valid value for this property.
<code>vbroker.ce.iiop.ccm.waitForCompletion</code>	<code>false</code>	This property can be set to <code>true</code> to specify that the application wants to wait for all replies to be received and only after then should the ORB should close the connection. The default value of <code>false</code> indicates that ORB will not wait for any replies.

Property	Default	Description
<code>vbroker.ce.iiop.connection.tcpNoDelay</code>	FALSE	When set to <code>TRUE</code> , the server's sockets are configured to send any data written to them immediately instead of batching the data as the buffer fills.
<code>vbroker.ce.iiop.clientPort</code>	0 (random port)	Specifies the client port to be used when a connection is opened by the ORB. Allowed values range from 0 to 65535. A range should be specified using the <code>vbroker.ce.iiop.clientPortRange</code> property when this property is used.
<code>vbroker.ce.iiop.clientPortRange</code>	0	Specifies the range of client ports to be used when a connection is opened by the ORB, starting with the port specified by the <code>vbroker.ce.iiop.clientPort</code> property. Allowed values range from 0 to 65535.
<code>vbroker.ce.iiop.host</code>	none	<p>Binds the client side sockets to a specified local address (or addresses), which can be useful when interacting with firewalls or routing tables.</p> <p>You can use this property to specify an address in IPv4 or IPv6 format, or to specify two addresses, one in each format, separated by a comma. For example:</p> <pre>vbroker.ce.iiop.host=192.168.0.1,fd0::1234:1</pre> <p>If you specify more than one address in the same format, the first valid address is used and an error message is generated.</p> <p>If you only specify one address it is used for both address types, enabling an IPv4-mapped IPv6 address to be used for both types.</p> <p>If no address is specified the value is left for the underlying system to determine.</p>

## URL Naming properties

This table lists the URL Naming properties.

Property	Default	Description
<code>vbroker.URLNaming.allowUserInteraction</code>	true	When set to <code>true</code> , allows the URL Naming Service to initiate the graphical user interface (GUI) for user interaction.
<code>vbroker.URLNaming.debug</code>	false	When set to <code>true</code> , specifies that the URLNaming Service display debugging information.

## QoS-related Properties

Property	Default	Description
<code>vbroker.orb.qos.relativeRTT</code>	0	This property can be used to set the <code>RelativeRoundtripTimeoutPolicy</code> in milliseconds. It takes effect at the ORB level and can be overridden programmatically at other levels. The default value of 0 means no timeout.
<code>vbroker.qos.cache</code>	True	Specifies if QoS policies should be cached per delegate, instead of being checked prior to every request made by the client.
<code>vbroker.orb.qos.connectionTimeout</code>	0 (no limit)	This property allows the convenience of setting the <code>RelativeConnectionTimeoutPolicy</code> QoS policy at the ORB level, without requiring explicit code to be written. The connection timeout value should be specified in milliseconds.

Property	Default	Description
<code>vbroker.qos.backcompat</code>	False	The default value of <code>false</code> exhibits the current <code>VB_NOTIFY_REBIND</code> behavior described in <a href="#">“Using Quality of Service (QoS)”</a> . A value of <code>true</code> reverts to the behavior of <code>VB_NOTIFY_REBIND</code> in VisiBroker version 6.5.
<code>vbroker.orb.socketTimeoutMonitorPeriod</code>	0	Set this property to start a thread which periodically monitors the socket write and connect timeout. The property value (in milliseconds) controls the period. The default value of 0 means that the monitoring thread is not started. Note that this feature is effective only when <code>vbroker.orb.tcpTimeout</code> is set. This timeout mechanism does not need a thread per connection to enforce invocation timeout, but the actual timeout may occur after <code>tcpTimeout + SocketTimeoutMonitorPeriod</code> .

## Server-side server engine properties

This table lists the server-side server engine properties.

Property	Default	Description
<code>vbroker.se.default</code>	<code>iiop_tp</code>	Specifies the default server engine.

## Server-side thread session IIOP\_TS/IIOP\_TS connection properties

The following table lists the server-side thread session IIOP\_TS/IIOP\_TS connection properties.

Property	Default	Description
<code>vbroker.se.iiop_ts.host</code>	<code>null</code>	Specifies the host name used by this server engine. The default value, <code>null</code> , means use the host name from the system.
<code>vbroker.se.iiop_ts.proxyHost</code>	<code>null</code>	Specifies the proxy host name used by this server engine. The default value, <code>null</code> , means use the host name from the system.
<code>vbroker.se.iiop_ts.scms</code>	<code>iiop_ts</code>	Specifies the list of Server Connection Manager name(s). One possible value for security would be <code>ssl</code> . See the <a href="#">VisiBroker Security Guide</a> for details.
<code>vbroker.se.iiop_ts.scm.iiop_ts.manager.type</code>	<code>Socket</code>	Specifies the type of Server Connection Manager.
<code>vbroker.se.iiop_ts.scm.iiop_ts.manager.connectionMax</code>	0	Specifies the maximum number of connections the server will accept. The default value, 0 (zero), implies no restriction.
<code>vbroker.se.iiop_ts.scm.iiop_ts.manager.connectionMaxIdle</code>	0	Specifies the time in seconds the server uses to determine if an inactive connection should be closed.
<code>vbroker.se.iiop_ts.scm.iiop_ts.listener.type</code>	<code>IIOP</code>	Specifies the type of protocol the listener is using.
<code>vbroker.se.iiop_ts.scm.iiop_ts.listener.port</code>	0	Specifies the port number that is used with the host name property. The default value, 0 (zero), specifies that the system will pick a random port number.
<code>vbroker.se.iiop_ts.scm.iiop_ts.listener.proxyPort</code>	0	Specifies the proxy port number used with the proxy host name property. The default value, 0 (zero), specifies that the system will pick a random port number.

Property	Default	Description
<code>vbroker.se.iiop_ts.scm.iiop_ts.listener.giopVersion</code>	1.2	This property can be used to resolve interoperability problems with older VisiBroker ORBs that cannot handle unknown minor GIOP versions correctly. Legal values for this property are 1.0, 1.1 and 1.2. For example, to make the nameservice produce a GIOP 1.1 IOR, start it like this:  <pre>nameserv -VBJprop vbroker.se.iiop_tp.scm. iiop_tp.listener.giopVersion=1.1</pre>
<code>vbroker.se.iiop_ts.scm.iiop_ts.dispatcher.type</code>	"Thread Session"	Specifies the type of thread dispatcher used in the Server Connection Manager.
<code>vbroker.se.iiop_ts.scm.iiop_ts.connection.keepAlive</code>	false	Set this property to true to enable TCP KeepAlive option.

## Server-side thread session BOA\_TS/BOA\_TS connection properties

This protocol has the same set of properties as the [“Server-side thread session IIOP\\_TS/IIOP\\_TS connection properties”](#), by replacing all `iiop_ts` with `boa_ts` in all the properties. For example, the `vbroker.se.iiop_ts.scm.iiop_ts.manager.connectionMax` will become `vbroker.se.boa_ts.scm.boa_ts.manager.connectionMax`. Also, the default value for `vbroker.se.boa_ts.scm` is `boa_ts`.

## Server-side thread pool IIOP\_TP/IIOP\_TP connection properties

The following table lists the server-side thread pool IIOP\_TP/IIOP\_TP connection properties.

Property	Default	Description
<code>vbroker.se.iiop_tp.host</code>	null	Specifies the host name that can be used by this server engine. The default value, <code>null</code> , means use the host name from the system. Host names or IP addresses are acceptable values.
<code>vbroker.se.iiop_tp.proxyHost</code>	null	Specifies the proxy host name that can be used by this server engine. The default value, <code>null</code> , means use the host name from the system. Host names or IP addresses are acceptable values.
<code>vbroker.se.iiop_tp.scm</code>	<code>iiop_tp</code>	Specifies the list of Server Connection Manager name(s).  One possible value for security would be <code>ssl</code> . See the <i>VisiBroker Security Guide</i> for details.
<code>vbroker.se.iiop_tp.scm.iiop_tp.manager.type</code>	Socket	Specifies the type of Server Connection Manager.
<code>vbroker.se.iiop_tp.scm.iiop_tp.manager.connectionMax</code>	0	Specifies the maximum number of cache connections on the server. The default value, 0 (zero), implies no restriction.
<code>vbroker.se.iiop_tp.scm.iiop_tp.manager.connectionMaxIdle</code>	0	Specifies the time, in seconds, that the server uses to determine if an inactive connection should be closed.
<code>vbroker.se.iiop_tp.scm.iiop_tp.listener.type</code>	IIOP	Specifies the type of protocol the listener is using.

Property	Default	Description
<code>vbroker.se.iiop_tp.scm.iiop_tp.listener.port</code>	0	Specifies the port number used with the host name property. The default value, 0 (zero), means that the system will pick a random port number.
<code>vbroker.se.iiop_tp.scm.iiop_tp.listener.portRange</code>	0 (zero)	This property is effective only when <code>listener.port</code> is greater than 0 (zero). If the listener cannot bind to that port because the port may be in use then the listener will try to bind to the ports in the range <code>[port, port+portRange]</code> . If no ports in the range are available then a <code>COMM_FAILURE</code> exception will be thrown.
<code>vbroker.se.iiop_tp.scm.iiop_tp.listener.proxyPort</code>	0	Specifies the proxy port number used with the proxy host name property. The default value, 0 (zero), means that the system will pick a random port number.
<code>vbroker.se.iiop_tp.scm.iiop_tp.dispatcher.type</code>	ThreadPool	Specifies the type of thread dispatcher used in the Server Connection Manager.
<code>vbroker.se.iiop_tp.scm.iiop_tp.dispatcher.threadMin</code>	0	Specifies the minimum number of threads that the Server Connection Manager can create.
<code>vbroker.se.iiop_tp.scm.iiop_tp.dispatcher.threadMax</code>	0	Specifies the maximum number of threads that the Server Connection Manager can create. The default value, 0 (zero) implies the ORB will control the thread generation using an internal algorithm based on heuristics.
<code>vbroker.se.iiop_tp.scm.iiop_tp.dispatcher.threadMaxIdle</code>	300	Specifies the time in seconds before an idle thread will be destroyed.
<code>vbroker.se.iiop_tp.scm.iiop_tp.connection.tcpNoDelay</code>	true	When this property is set to false, this turns on buffering for the socket. The default value, true, turns off buffering, so that all packets are sent as soon as they are ready.
<code>vbroker.se.iiop_tp.scm.iiop_tp.connection.keepAlive</code>	false	Set this property to true to enable TCP KeepAlive option.

## Server-side thread pool BOA\_TP/BOA\_TP connection properties

This protocol has the same set of properties as the [“Server-side thread pool IIOP\\_TP/IIOP\\_TP connection properties”](#), by replacing all `iiop_tp` with `boa_tp` in all the properties. For example, the `vbroker.se.iiop_tp.scm.iiop_tp.manager.connectionMax` will become `vbroker.se.boa_tp.scm.boa_tp.manager.connectionMax`. Also, the default value for `vbroker.se.boa_tp.scm` is `boa_tp`.

## Properties that support bi-directional communication

The following table lists the properties that support bi-directional communication. These properties are evaluated only once—when the SCMs are created. In all cases, the `exportBiDir` and `importBiDir` properties on the SCMs are given priority over the `enableBiDir` property. In other words, if both properties are set to conflicting values, the SCM-specific properties will

take effect. This allows you to set the `enableBiDir` property globally and specifically turn off bi-directional communication in individual SCMs.

Property	Default	Description
<code>vbroker.orb.enableBiDir</code>	<code>none</code>	You can selectively make bi-directional connections. If the client defines <code>vbroker.orb.enableBiDir=client</code> and the server defines <code>vbroker.orb.enableBiDir=server</code> the value of <code>vbroker.orb.enableBiDir</code> at the GateKeeper determines the state of the connection. Values of this property are: <code>server</code> , <code>client</code> , <code>both</code> or <code>none</code> .
<code>vbroker.se.&lt;se&gt;.scm.&lt;scm&gt;.manager.exportBiDir</code>		By default, this property is not set by the ORB. This is a client-side property. Setting it to <code>true</code> enables creation of a bi-directional callback POA on the specified server engine. Setting it to <code>false</code> disables creation of a bidirectional POA on the specified server engine.
<code>vbroker.se.&lt;se&gt;.scm.&lt;scm&gt;.manager.importBiDir</code>		By default, this property is not set by the ORB. This is a server-side property. Setting it to <code>true</code> allows the server-side to reuse the connection already established by the client for sending requests to the client. Setting it to <code>false</code> prevents reuse of connections in this fashion.

## Debug Logging Properties

This section details the properties that can be used to control and configure the output of debug log statements.

VisiBroker for Java internally uses Log4J infrastructure for logging.

The debug log statements are categorized according to the areas of the ORB from where they are logged. These categories are called source names. Currently the following source names are logged:

- `connection`: logs from the connection-related source areas such as client side connection, server side connection, connection pool etc
- `client`: logs from the client side invocation path
- `agent`: logs for Osagent communication
- `cdr`: logs for GIOP areas
- `se`: logs from the server engine, such as dispatcher, listener etc
- `server`: logs from the server side invocation path
- `orb`: logs from the ORB
- `naming`: logs from Naming Service
- `gatekeeper`: logs from Gatekeeper
- `time`: logs from Time Service



## Enabling and filtering

The following table describes the properties used to enable logging and filtering.

Property	Default	Description
<code>vbroker.log.enable</code>	<code>false</code>	<p>When set to true, all logging statements will be produced unless the log is being filtered.</p> <p>Values are true or false.</p>
<code>vbroker.log.async</code>	<code>false</code>	<p>When set to true, the logger switches to asynchronous mode. This feature is mainly designed to improve logging performance of <code>FileAppender</code>.</p> <p>After the logger retrieves an event from the pool, it will construct a message with logging information created with predefined layout, pushed to message queues, and return immediately to avoid IO blocking which will increase the performance of main thread.</p> <p>Another pool of threads consistently listens to these queues and writes to a configured file destination.</p>
<code>vbroker.log.logLevel</code>	<code>debug</code>	<p>Specifies the logging level of the log message. Logs with log levels equal to the specified level or above are forwarded. This property is applied at the global level.</p> <p>Values are <code>emerg</code>, <code>alert</code>, <code>crit</code>, <code>err</code>, <code>warning</code>, <code>notice</code>, <code>info</code> and <code>debug</code> ranking from the highest to the lowest.</p> <p>The meaning of the log levels are:</p> <ul style="list-style-type: none"><li>• <code>emerg</code> - indicates a panic condition.</li><li>• <code>alert</code> - a condition that requires user attention, for example if security has been disabled.</li><li>• <code>crit</code> - critical conditions, such as a device error.</li><li>• <code>err</code> - error conditions.</li><li>• <code>warning</code> - warning conditions. These may accompany some troubleshooting advice.</li><li>• <code>notice</code> - conditions that are not errors but may require some attention.</li><li>• <code>info</code> - informational, such as binding in progress.</li><li>• <code>debug</code> - debug conditions used by developers.</li></ul>
<code>vbroker.log.default.filter.register</code>	<code>null</code>	<p>Register source name for controlling (filtering) the logs from that source.</p> <p>Values are <code>client</code>, <code>server</code>, <code>connection</code>, <code>cdr</code>, <code>se</code>, <code>agent</code> and <code>orb</code>. Multiple values can be provided as a comma-separated string.</p> <p><b>Note:</b> The source names must be registered using this property before they can be explicitly controlled using <code>vbroker.log.default.filter.&lt;source-name&gt;.enable</code> and <code>vbroker.log.default.filter.&lt;source-name&gt;.logLevel</code> properties.</p>

Property	Default	Description
<code>vbroker.log.default.filter.&lt;source-name&gt;.enable</code>	true	Once a source name is registered, log output from the source can be explicitly controlled using this property.  Values are true or false.
<code>vbroker.log.default.filter.&lt;source-name&gt;.logLevel</code>	debug	This property provides finer-grained control over the global log level property. The log level specified using this property explicitly applies to the given source name.  The possible values are similar to the global logLevel values.
<code>vbroker.log.default.filter.all.enable</code>	true	This is a special case of the previous property where an inbuilt source name "all" is being used. "all" here denotes all the source names that have not been registered.

## Appending and logging

The output of the logs can be appended to specific destinations and formatted using specific layouts. VisiBroker for Java uses the appenders and layouts provided by Log4J for these purposes. Two inbuilt appenders "stdout" and "rolling" implement console and rolling file implementation. Apart from the various layouts available with Log4J, two inbuilt layouts "simple" and "xml" provide good layout capabilities.

stdout – Name of the Console appender type.

rolling – Name of the rolling file appender type.

simple – Name of a simple predefined output layout type.

xml – Name of Log4J XML event layout type.

The following table describes the properties used to configure the destination of the log output and its format.

Property	Default	Description
<code>vbroker.log.default.appenders</code>	stdout	List of comma-separated appenders for specifying log output destination. Values are stdout, rolling and/or any user-specified appender name. User can further specify the appenders using: <code>log4j.appender.&lt;name&gt;=&lt;full class name in log4j&gt;</code>
<code>vbroker.log.default.appender.&lt;appender-inst-name&gt;.layoutType</code>	PatternLayout	Type of layout (format) to be associated with the registered appender destination.  Values are PatternLayout, simple, xml and/or the full class name of all the Log4J supported layouts.

For the built-in rolling appender type, you can create the following configurations.

Property	Default	Description
<code>vbroker.log.default.appender.rolling.logDir</code>	<code>&lt;current_directory&gt;</code>	Directory for the rolling log file to reside in.
<code>vbroker.log.default.appender.rolling.fileName</code>	<code>vbrolling.log</code>	Name of rolling log file.
<code>vbroker.log.default.appender.rolling.maxFileSize</code>	10	Size in MB for each backup before rolling over. Values $\geq 1$ .
<code>vbroker.log.default.appender.rolling.maxBackupIndex</code>	1	Number of backups needed. When set to 0 (zero), no backup is created and logging will keep on appending to the file. Values $\geq 0$ .

## Deprecated properties

The following properties are deprecated at version 8.5.

Deprecated Property	Recommended Property
<code>vbroker.orb.debug</code>	<code>vbroker.log.enable</code>
<code>vbroker.orb.logLevel</code>	<code>vbroker.log.logLevel</code>
<code>vbroker.agent.debug</code>	<code>vbroker.log.default.filter.agent.enable</code>
<code>vbroker.locationservice.debug</code>	<code>vbroker.log.default.filter.agent.enable</code>
<code>vbroker.poa.logLevel</code>	<code>vbroker.log.default.filter.server.logLevel</code>
<code>vbroker.gatekeeper.passthru.logLevel</code>	<code>vbroker.log.default.filter.gatekeeper.logLevel</code>
<code>vbroker.orb.logger.output</code>	<code>vbroker.log.default.appenders</code>

## Setting properties in an applet

Setting properties for applets can only be done in the applet parameters. For example:

```
<APPLET archive="vbjorb.jar, vbsec.jar" CODE="ClientApplet.class">  
<PARAM NAME="org.omg.CORBA.ORBClass" VALUE="com.inprise.vbroker.orb.ORB">  
<PARAM NAME="vbroker.orb.alwaysTunnel" VALUE="true">  
</APPLET>
```

### Note:

VisiBroker 3.x-style command-line options cannot be used as applet parameters.

## Web services run-time properties

Using the properties listed, you can enable the run time.

Property	Default	Description
<code>vbroker.ws.enable</code>	<code>false</code>	Takes in a Boolean <code>true</code> or <code>false</code> parameter. Setting this value to <code>true</code> will enable the VisiBroker Web Services Runtime.

## Web services HTTP Listener properties

To configure the HTTP Listener, use the properties listed in the following table.

Property	Default	Description
<code>vbroker.se.ws.Host</code>	<code>null</code>	Specifies the host name to be used by the listener.
<code>vbroker.se.ws.proxyHost</code>	<code>null</code>	Specifies the proxy host name used by the web services engine. Default value <code>null</code> means use the host name from the system.

Property	Default	Description
<code>vbroker.se.ws.scm.ws_ts.listener.port</code>	80	Specifies the port number to be used by the listener socket.
<code>vbroker.se.ws.scm.ws_ts.listener.type</code>	WS	Specifies the protocol the listener is using. A value of WS-HIOPS will start a secure (https-based) listener.

## Web services Connection Manager properties

Using the properties listed below, you can configure the Web services Connection Manager.

Property	Default	Description
<code>vbroker.se.ws.scm.ws_ts.manager.connectionMax</code>	0	If <code>keepAliveConnection</code> is true, this property specifies the maximum number of connections the server will accept. Default 0 indicates no restriction.
<code>vbroker.se.ws.scm.ws_ts.manager.connectionMaxIdle</code>	0	This property determines the maximum time an unused connection will remain alive
<code>vbroker.se.ws.scm.ws_ts.manager.type</code>	Socket	Specifies the type of Server Connection Manager
<code>vbroker.se.ws.scm.ws_ts.connection.keepAlive</code>	false	Set this property to true to enable TCP KeepAlive option.

## SOAP Request Dispatcher properties

This table lists the SOAP Request Dispatcher properties.

Property	Default	Description
<code>vbroker.se.ws.scm.ws_ts.dispatcher.threadMax</code>	0	Maximum number of threads to be present in the thread pool dispatcher. Default value 0 indicates unlimited number of threads.
<code>vbroker.se.ws.scm.ws_ts.dispatcher.threadMin</code>	0	Minimum number of threads to be present in the thread pool dispatcher.
<code>vbroker.se.ws.scm.ws_ts.dispatcher.threadMaxIdle</code>	300	Time in seconds before an idle thread in the thread pool is destroyed.
<code>vbroker.se.ws.scm.ws_ts.dispatcher.type</code>	Thread Session	Specifies the type of thread dispatcher used in the Server Connection Manager.

## Getting the ORB version programmatically

When using VisiBroker for Java, you can obtain the ORB version string by calling the `getVersion` method on the `com.inprise.vbroker.ORB` class, as shown in the following example:

```
String orbVersion =
    com.inprise.vbroker.ORB.getVersion();
```

The version string appears in the format shown the following example:

```
...VisiBroker for Java [08.05.xx.xx]
```

**Note:**

This method is static, so calling it does not require initializing the ORB.



# Handling exceptions

## Exceptions in the CORBA model

The exceptions in the CORBA model include both *system* and *user exceptions*. The CORBA specification defines a set of system exceptions that can be raised when errors occur in the processing of a client request. Also, system exceptions are raised in the case of communication failures. System exceptions can be raised at any time and they do not need to be declared in the interface.

You can define user exceptions in IDL for objects you create and specify the circumstances under which those exceptions are to be raised. They are included in the method signature. If an object raises an exception while handling a client request, the VisiBroker ORB is responsible for reflecting this information back to the client.

## System exceptions

System exceptions are usually raised by the VisiBroker ORB, though it is possible for object implementations to raise them through interceptors discussed in [“Using VisiBroker Interceptors”](#). When the VisiBroker ORB raises a `SystemException`, one of the CORBA-defined error conditions is displayed as shown below.

For a listing of explanations and possible causes of these exceptions, see [“CORBA exceptions”](#).

Exception name	Description
BAD_CONTEXT	Error processing context object.
BAD_INV_ORDER	Routine invocations out of order.
BAD_OPERATION	Invalid operation.
BAD_PARAM	An invalid parameter was passed.
BAD_QOS	Quality of service cannot be supported.
BAD_TYPECODE	Invalid typecode.
COMM_FAILURE	Communication failure.
DATA_CONVERSION	Data conversion error.
FREE_MEM	Unable to free memory.
IMP_LIMIT	Implementation limit violated.
INITIALIZE	VisiBroker ORB initialization failure.
INTERNAL	VisiBroker ORB internal error.
INTF_REPOS	Error accessing interface repository.
INV_FLAG	Invalid flag was specified.
INV_INDENT	Invalid identifier syntax.
INV_OBJREF	Invalid object reference specified.
INVALID_TRANSACTION	Specified transaction was invalid (used in conjunction with <code>VisiTransact</code> ).
MARSHAL	Error marshalling parameter or result.
NO_IMPLEMENT	Operation implementation not available.
NO_MEMORY	Dynamic memory allocation failure.
NO_PERMISSION	No permission for attempted operation.
NO_RESOURCES	Insufficient resources to process request.
NO_RESPONSE	Response to request not yet available.

Exception name	Description
OBJ_ADAPTOR	Failure detected by object adaptor.
OBJECT_NOT_EXIST	Object is not available.
PERSIST_STORE	Persistent storage failure.
TRANSIENT	Transient failure.
TRANSACTION_MODE	Mismatch detected between the <code>TransactionPolicy</code> in the IOR and the current transaction mode (used in conjunction with <code>VisiTransact</code> ).
TRANSACTION_REQUIRED	Transaction is required (used in conjunction with <code>VisiTransact</code> ).
TRANSACTION_ROLLEDBACK	Transaction was rolled back (used in conjunction with <code>VisiTransact</code> ).
TRANSACTION_UNAVAILABLE	Connection to the <code>VisiTransact Transaction Service</code> has been abnormally terminated.
TIMEOUT	Request timeout.
UNKNOWN	Unknown exception.

## SystemException class

```
public abstract class org.omg.CORBA.SystemException
extends java.lang.RuntimeException {
    protected SystemException(java.lang.String reason,
        int minor, CompletionStatus completed) { ... }
    public String toString() { ... }
    public CompletionStatus completed;
    public int minor;
}
```

## Obtaining completion status

System exceptions have a completion status that tells you whether or not the operation that raised the exception was completed. The sample below illustrates the `CompletionStatus` enumerated values for the `CompletionStatus`. `COMPLETED_MAYBE` is returned when the status of the operation cannot be determined.

```
enum CompletionStatus {
    COMPLETED_YES = 0;
    COMPLETED_NO = 1;
    COMPLETED_MAYBE = 2;
};
```

## Catching system exceptions

Your applications should enclose the `VisiBroker ORB` and remote calls in a try catch block. The code samples below illustrate how the account client program, discussed in [“Developing an example application with VisiBroker”](#), prints an exception.

```
public class Client {
    public static void main(String[] args) {
        try {
            org.omg.CORBA.ORB orb = org.omg.CORBA.ORB.init(args,null);
            byte[] managerId = "BankManager".getBytes();
            Bank.AccountManager manager =
                Bank.AccountManagerHelper.bind(orb, "/bank_agent_poa", managerId);
            String name = args.length > 0 ? args[0] : "Jack B. Quick";
```



```

Bank.Account account = manager.open(name);
float balance = account.balance();
System.out.println("The balance in " + name + "'s account is $" +
    balance);
} catch (Exception e) {
    System.err.println(e);
}
}
}

```

If you were to execute the client program with these modifications and without a server present, the following output would indicate that the operation did not complete and the reason for the exception.

```

prompt>vbj Client
org.omg.CORBA.OBJECT_NOT_EXIST:
Could not locate the following POA:
poa name : /bank_agent_poa
minor code: 0 completed: No

```

## Downcasting exceptions to a system exception

You can modify the account client program to attempt to downcast any exception that is caught to a `SystemException`. The following code sample shows you how to modify the client program.

```

public class Client {
    public static void main(String[] args) {
        try {
            // Initialize the ORB
            org.omg.CORBA.ORB orb = org.omg.CORBA.ORB.init(args, null);
            // Bind to an account
            Account account = AccountHelper.bind(orb, "/bank_poa",
                "BankAccount".getBytes());
            // Get the balance of the account
            float balance = account.balance();
            // Print the account balance
            System.out.println("The account balance is $" + balance);
            catch(Exception e) {
                if (e instanceof org.omg.CORBA.SystemException) {
                    System.err.println("System Exception occurred:");
                } else {
                    System.err.println("Not a system exception");
                }
            }
            System.err.println(e);
        }
    }
}

```

The following code sample displays the resulting output if a system exception occurs.

```

System Exception occurred:
in thread "main" org.omg.CORBA.OBJECT_NOT_EXIST minor
code: 0 completed: No

```

## Catching specific types of system exceptions

Rather than catching all types of exceptions, you may choose to specifically catch each type of exception that you expect. The following code sample show this technique.

```

public class Client {
    public static void main(String[] args) {
        try {
            org.omg.CORBA.ORB orb = org.omg.CORBA.ORB.init(args,null);
            byte[] managerId = "BankManager".getBytes();
            Bank.AccountManager manager =
                Bank.AccountManagerHelper.bind(orb, "/bank_agent_poa", managerId);
            String name = args.length > 0 ? args[0] : "Jack B. Quick";
            Bank.Account account = manager.open(name);
            float balance = account.balance();
            System.out.println("The balance in " + name + "'s account is
                $" + balance);
        } catch(org.omg.CORBA.SystemException e) {
            System.err.println("System Exception occurred:");
            System.err.println(e);
        }
    }
}

```

## User exceptions

When you define your object's interface in IDL, you can specify the user exceptions that the object may raise. The following code sample shows the `UserException` code from which the `idl2java` compiler will derive the user exceptions you specify for your object.

```

public abstract class UserException extends
    java.lang.Exception {
    protected UserException();
    protected UserException(String reason);
}

```

## Defining user exceptions

Suppose that you want to enhance the account application, introduced in [“Developing an example application with VisiBroker”](#), so that the account object will raise an exception. If the account object has insufficient funds, you want a user exception named `AccountFrozen` to be raised. The additions required to add the user exception to the IDL specification for the `Account` interface are shown in bold.

```

// Bank.idl
module Bank {
    interface Account {
        exception AccountFrozen {
        };
        float balance() raises(AccountFrozen);
    };
};

```

The `idl2java` compiler will generate the following code for an `AccountFrozen` exception class.

```

package Bank;
public interface Account extends
    com.inprise.vbroker.CORBA.Object,
    Bank.AccountOperations,
    org.omg.CORBA.portable.IDLEntity {
}
package Bank;

```

```

public interface AccountOperations {
    public float balance () throws
Bank.AccountPackage.AccountFrozen;
}
package Bank.AccountPackage;
public final class AccountFrozen extends
org.omg.CORBA.UserException {
    public AccountFrozen () { ... }
    public AccountFrozen (java.lang.String _reason) { ... }
    public synchronized java.lang.String toString() { ... }
}

```

## Modifying the object to raise the exception

The AccountImpl object must be modified to use the exception by raising the exception under the appropriate error conditions.

```

public class AccountImpl extends Bank.AccountPOA {
    public AccountImpl(float balance) {
        _balance = balance;
    }
    public float balance() throws AccountFrozen {
        if (_balance < 50) {
            throws AccountFrozen();
        } else {
            return _balance;
        }
    }
    private float _balance;
}

```

## Catching user exceptions

When an object implementation raises an exception, the VisiBroker ORB is responsible for reflecting the exception to your client program. Checking for a UserException is similar to checking for a SystemException. To modify the account client program to catch the AccountFrozen exception, make modifications to the code as shown below.

```

public class Client {
    public static void main(String[] args) {
        try {
            // Initialize the ORB
            org.omg.CORBA.ORB orb =
org.omg.CORBA.ORB.init(args, null);
            // Bind to an account
            Account account = AccountHelper.bind(orb, "/"
bank_poa",
                "BankAccount".getBytes());
            // Get the balance of the account
            float balance = account.balance();
            // Print the account balance
            System.out.println("The account balance is $" +
balance);
        }
        // Check for AccountFrozen exception
        catch(Account.AccountFrozen e) {
            System.err.println("AccountFrozen returned:");
            System.err.println(e);
        }
        // Check for system errors
        catch(org.omg.CORBA.SystemException sys_excep) {

```

```
    }  
    }  
    ...  
}
```

### Adding fields to user exceptions

You can associate values with user exceptions. The code sample below shows how to modify the IDL interface specification to add a reason code to the `AccountFrozen` user exception. The object implementation that raises the exception is responsible for setting the reason code. The reason code is printed automatically when the exception is put on the output stream.

```
// Bank.idl  
module Bank {  
    interface Account {  
        exception AccountFrozen {  
            int reason;  
        };  
        float balance() raises(AccountFrozen);  
    };  
};
```

# Server basics

This section outlines the tasks that are necessary to set up a server to receive client requests.

## Overview

The basic steps that you'll perform in setting up your server are:

- Initialize the VisiBroker ORB
- Create and setup the POA
- Activate the POA Manager
- Activate objects
- Wait for client requests

This section describes each task in a global manner to give you an idea of what you must consider. The specifics of each step are dependent on your individual requirements.

## Initializing the VisiBroker ORB

As stated in the previous section, the VisiBroker ORB provides a communication link between client requests and object implementations. Each application must initialize the VisiBroker ORB before communicating with it as follows:

```
// Initialize the VisiBroker ORB.  
org.omg.CORBA.ORB orb=org.omg.CORBA.ORB.init(args,null);
```

## Creating the POA

Early versions of the CORBA object adapter (the *Basic Object Adapter*, or *BOA*) did not permit portable object server code. A new specification was developed by the OMG to address these issues and the *Portable Object Adapter* (POA) was created.

A discussion of the POA can be quite extensive. This section introduces you to some of the basic features of the POA. For detailed information, see [“Using POAs”](#) and the OMG specification.

In basic terms, the POA (and its components) determine which *servant* should be invoked when a client request is received, and then invokes that servant. A servant is a programming object that provides the implementation of an *abstract object*. A servant is not a CORBA object.

One POA (called the *rootPOA*) is supplied by each VisiBroker ORB. You can create additional POAs and configure them with different behaviors. You can also define the characteristics of the objects the POA controls.

The steps to setting up a POA with a servant include:

- Obtaining a reference to the root POA
- Defining the POA policies
- Creating a POA as a child of the root POA
- Creating a servant and activating it

- Activating the POA through its manager

Some of these steps may be different for your application.

## Obtaining a reference to the root POA

All server applications must obtain a reference to the root POA to manage objects or to create new POAs.

```
//2. Get a reference to the root POA
org.omg.CORBA.Object obj =
orb.resolve_initial_reference("RootPOA");
// Narrow the object reference to a POA reference
POA rootPoa =
org.omg.PortableServer.POAHelper.narrow(obj);
```

You can obtain a reference to the root POA by using `resolve_initial_references` which returns a value of type `CORBA::Object`. You are responsible for narrowing the returned object reference to the desired type, which is `PortableServer::POA` in the above example.

You can then use this reference to create other POAs, if needed.

## Creating the child POA

The root POA has a predefined set of *policies* that cannot be changed. A policy is an object that controls the behavior of a POA and the objects the POA manages. If you need a different behavior, such as different lifespan policy, you will need to create a new POA.

POAs are created as children of existing POAs using `create_POA`. You can create as many POAs as you think are required.

### Note

Child POAs do not inherit the policies of their parent POAs.

In the following example, a child POA is created from the root POA and has a persistent lifespan policy. The POA Manager for the root POA is used to control the state of this child POA.

```
// Create policies for our persistent POA
org.omg.CORBA.Policy[] policies =
    {rootPoa.create_lifespan_policy(
        LifespanPolicyValue.PERSISTENT)
    };
// Create myPOA with the right policies
POA myPOA = rootPoa.create_POA( "bank_agent_poa",
    rootPoa.the_POAManager(),
    policies );
```

## Implementing servant methods

IDL has a syntax similar to Java and can be used to define modules, interfaces, data structures, and more. When you compile IDL that contains an interface, a class is generated which serves as the base class for your servant. For example, in the `Bank.IDL` file, there is an `AccountManager` interface:

```
module Bank{
    interface Account {
        float balance();
    };
    interface AccountManager {
        Account open (in string name);
    };
};
```

The following shows the `AccountManager` implementation on the server side.

`AccountManagerPOA.java` is created and serves as the skeleton code (implementation base code) for the `AccountManager` object implementation on the server side, as follows:

```
import org.omg.PortableServer.*;
import java.util.*;
public class AccountManagerImpl extends
Bank.AccountManagerPOA {
    public synchronized Bank.Account open(String name) {
        // Lookup the account in the account dictionary.
        Bank.Account account = (Bank.Account)
        _accounts.get(name);
        // If there was no account in the dictionary, create
one.
        if(account == null) {
            // Make up the account's balance, between 0 and
1000 dollars.
            float balance = Math.abs(_random.nextInt()) %
100000 / 100f;
            // Create the account implementation, given the
balance.
            AccountImpl accountServant = new
AccountImpl(balance);
            try {
                // Activate it on the default POA which is
root POA for this
                servant
                account =
Bank.AccountHelper.narrow(_default_POA().
servant_to_reference(accountServant));
            } catch (Exception e) {
                e.printStackTrace();
            }
            // Print out the new account.
            System.out.println("Created " + name + "'s
account: " + account);
            // Save the account in the account dictionary.
            _accounts.put(name, account);
        }
        // Return the account.
        return account;
    }
    private Dictionary _accounts = new Hashtable();
    private Random _random = new Random();
}
```

## Creating and Activating the Servant

The AccountManager implementation must be created and activated in the server code. In this example, AccountManager is activated with `activate_object_with_id`, which passes the object ID to the *Active Object Map* where it is recorded. The Active Object Map is simply a table that maps IDs to servants. This approach ensures that this object is always available when the POA is active and is called *explicit object activation*.

```
// Create the servant
AccountManagerImpl managerServant = new
AccountManagerImpl();
// Decide on the ID for the servant
byte[] managerId = "BankManager".getBytes();
// Activate the servant with the ID on myPOA
myPOA.activate_object_with_id(managerId, managerServant);
```

## Activating the POA

The last step is to activate the POA Manager associated with your POA. By default, POA Managers are created in a *holding* state. In this state, all requests are routed to a holding queue and are not processed. To allow requests to be dispatched, the *POA Manager* associated with the POA must be changed from the holding state to an active state. A POA Manager is simply an object that controls the state of the POA (whether requests are queued, processed, or discarded.) A POA Manager is associated with a POA during POA creation. You can specify a POA Manager to use, or let the system create a new one for you by passing a null value as the POA Manager name in `create_POA()`.

```
// Activate the POA Manager
rootPOA.the_POAManager().activate();
```

## Activating objects

In the preceding section, there was a brief mention of explicit object activation. There are several ways in which objects can be activated:

- **Explicit:** All objects are activated upon server start-up via calls to the POA
- **On-demand:** The servant manager activates an object when it receives a request for a servant not yet associated with an object ID
- **Implicit:** Objects are implicitly activated by the server in response to an operation by the POA, not by any client request
- **Default servant:** The POA uses the default servant to process the client request

A complete discussion of object activation is in [“Using POAs”](#). For now, just be aware that there are several means of activating objects.



## Waiting for client requests

Once your POA is set up, you can wait for client requests by using `orb.run()`. This process will run until the server is terminated.

```
// Wait for incoming requests.
orb.run();
```

## Complete example

The sample below shows the complete example code.

```
// Server.java
import org.omg.PortableServer.*;
public class Server {
public static void main(String[] args) {
    try {
        // Initialize the ORB.
        org.omg.CORBA.ORB orb =
org.omg.CORBA.ORB.init(args,null);
        // get a reference to the root POA
        POA rootPOA =
POAHelper.narrow(orb.resolve_initial_references("RootPOA")
);
        // Create policies for our persistent POA
        org.omg.CORBA.Policy[] policies = {

rootPOA.create_lifespan_policy(LifespanPolicyValue.PERSIST
ENT)
        };
        // Create myPOA with the right policies
        POA myPOA = rootPOA.create_POA( "bank_agent_poa",
rootPOA.the_POAManager(),
        policies );
        // Create the servant
        AccountManagerImpl managerServant = new
AccountManagerImpl();
        // Decide on the ID for the servant
        byte[] managerId = "BankManager".getBytes();
        // Activate the servant with the ID on myPOA
        myPOA.activate_object_with_id(managerId,
managerServant);
        // Activate the POA manager
        rootPOA.the_POAManager().activate();

System.out.println(myPOA.servant_to_reference(managerServa
nt) + " is ready.");
        // Wait for incoming requests
        orb.run();
    } catch (Exception e) {
        e.printStackTrace();
    }
}
}
```



# Using POAs

## What is a Portable Object Adapter?

Portable Object Adapters replace Basic Object Adapters; they provide portability on the server side.

A POA is the intermediary between the implementation of an object and the VisiBroker ORB. In its role as an intermediary, a POA routes requests to servants and, as a result may cause servants to run and create child POAs if necessary.

Servers can support multiple POAs. At least one POA must be present, which is called the rootPoa. The rootPoa is created automatically for you. The set of POAs is hierarchical; all POAs have the rootPoa as their ancestor.

Servant managers locate and assign servants to objects for the POA. When an abstract object is assigned to a servant, it is called an active object and the servant is said to incarnate the active object. Every POA has one Active Object Map which keeps track of the object IDs of active objects and their associated active servants.

### Note

Users familiar with versions of VisiBroker prior to 6.0 should note the change in inheritance hierarchy to support CORBA Specification 3.0, which requires local interfaces. For example, a ServantLocator implementation would now extend from

`org.omg.PortableServer._ServantLocatorLocalBase` instead of `org.omg.PortableServer.ServantLocatorPOA`.

**Figure 5** Overview of the POA

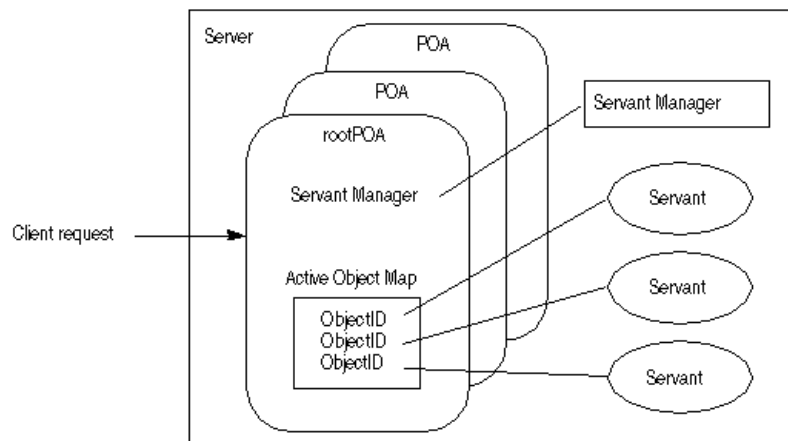

## POA terminology

Following are definitions of some terms with which you will become more familiar as you read through this section.

Term	Description
Active Object Map	Table that maps active VisiBroker CORBA objects (through their object IDs) to servants. There is one Active Object Map per POA.
adapter activator	Object that can create a POA on demand when a request is received for a child POA that does not exist.
etherealize	Remove the association between a servant and an abstract CORBA object.
incarnate	Associate a servant with an abstract CORBA object.
ObjectID	Way to identify a CORBA object within the object adapter. An ObjectID can be assigned by the object adapter or the application and is unique only within the object adapter in which it was created. Servants are associated with abstract objects through ObjectIDs.
persistent object	CORBA objects that live beyond the server process that created them.
POA manager	Object that controls the state of the POA; for example, whether the POA is receiving or discarding incoming requests.
Policy	Object that controls the behavior of the associated POA and the objects the POA manages.
rootPoa	Each VisiBroker ORB is created with one POA called the rootPoa. You can create additional POAs (if necessary) from the rootPoa.
servant	Any code that implements the methods of a CORBA object, but is not the CORBA object itself.
servant manager	An object responsible for managing the association of objects with servants, and for determining whether an object exists. More than one servant manager can exist.
transient object	A CORBA object that lives only within the process that created it.

## Steps for creating and using POAs

Although the exact process can vary, the basic steps that occur during the POA lifecycle are:

- 1 Define the POA's policies.
- 2 Create the POA.
- 3 Activate the POA through its POA manager.
- 4 Create and activate servants.
- 5 Create and use servant managers.
- 6 Use adapter activators.

Depending on your needs, some of these steps may be optional. For example, you only have to activate the POA if you want it to process requests.

## POA policies

Each POA has a set of policies that define its characteristics. When creating a new POA, you can use the default set of policies or use different values to suit your requirements. You can only set the policies when creating a POA; you can not change the policies of an existing POA. POAs do not inherit the policies from their parent POA.

The following lists the POA policies, their values, and the default value (used by the rootPoa).

- **Thread policy** The thread policy specifies the threading model to be used by the POA.

The thread policy can have the following values:

- **ORB\_CTRL\_MODEL:** (Default) The POA is responsible for assigning requests to threads. In a multi-threaded environment, concurrent requests may be delivered using multiple threads. Note that VisiBroker uses multi-threading model.
- **SINGLE\_THREAD\_MODEL:** The POA processes requests sequentially. In a multi-threaded environment, all calls made by the POA to servants and servant managers are thread-safe.
- **MAIN\_THREAD\_MODEL:** Calls are processed on a distinguished “main” thread. Requests for all main-thread POAs are processed sequentially. In a multi-threaded environment, all calls processed by all POAs with this policy are thread-safe. The application programmer designates the main thread by calling `ORB::run()` or `ORB::perform_work()`. For more information about these methods, see “Activating objects”.
- **Lifespan policy** The lifespan policy specifies the lifespan of the objects implemented in the POA.

The lifespan policy can have the following values:

- **TRANSIENT:** (Default) A transient object activated by a POA cannot outlive the POA that created it. Once the POA is deactivated, an `OBJECT_NOT_EXIST` exception occurs if an attempt is made to use any object references generated by the POA.
- **PERSISTENT:** A persistent object activated by a POA can outlive the process in which it was first created. Requests invoked on a persistent object may result in the implicit activation of a process, a POA and the servant that implements the object.
- **Object ID Uniqueness policy** The Object ID Uniqueness policy allows a single servant to be shared by many abstract objects.

The Object ID Uniqueness policy can have the following values:

- **UNIQUE\_ID:** (Default) Activated servants support only one Object ID.
- **MULTIPLE\_ID:** Activated servants can have one or more Object IDs. The Object ID must be determined within the method being invoked at run time.
- **ID Assignment policy** The ID assignment policy specifies whether object IDs are generated by server applications or by the POA.

The ID Assignment policy can have the following values:

- **USER\_ID:** Objects are assigned object IDs by the application.
- **SYSTEM\_ID:** (Default) Objects are assigned object IDs by the POA. If the **PERSISTENT** policy is also set, object IDs must be unique across all instantiations of the same POA.

Typically, `USER_ID` is for persistent objects, and `SYSTEM_ID` is for transient objects. If you want to use `SYSTEM_ID` for persistent objects, you can extract them from the servant or object reference.

- **Servant Retention policy** The Servant Retention policy specifies whether the POA retains active servants in the Active Object Map.

The Servant Retention policy can have the following values:

- **RETAIN:** (Default) The POA tracks object activations in the Active Object Map. RETAIN is usually used with `ServantActivators` or explicit activation methods on POA.
- **NON\_RETAIN:** The POA does not retain active servants in the Active Object Map. NON\_RETAIN must be used with `ServantLocators`.  
`ServantActivators` and `ServantLocators` are types of servant managers. For more information on servant managers, see [“Using servants and servant managers”](#).
- **Request Processing policy** The Request Processing policy specifies how requests are processed by the POA.
  - **USE\_ACTIVE\_OBJECT\_MAP\_ONLY:** (Default) If the Object ID is not listed in the Active Object Map, an `OBJECT_NOT_EXIST` exception is returned. The POA must also use the RETAIN policy with this value.
  - **USE\_DEFAULT\_SERVANT:** If the Object ID is not listed in the Active Object Map or the NON\_RETAIN policy is set, the request is dispatched to the default servant. If no default servant has been registered, an `OBJ_ADAPTER` exception is returned. The POA must also use the MULTIPLE\_ID policy with this value.
  - **USE\_SERVANT\_MANAGER:** If the Object ID is not listed in the Active Object Map or the NON\_RETAIN policy is set, the servant manager is used to obtain a servant.
- **Implicit Activation policy** The Implicit Activation policy specifies whether the POA supports implicit activation of servants.

The Implicit Activation policy can have the following values:

- **IMPLICIT\_ACTIVATION:** The POA supports implicit activation of servants. There are two ways to activate the servants as follows:
  - Converting them to an object reference with `org.omg.PortableServer.POA.servant_to_reference()`.
  - Invoking `_this()` on the servant.
 The POA must also use the SYSTEM\_ID and RETAIN policies with this value.
- **NO\_IMPLICIT\_ACTIVATION:** (Default) The POA does not support implicit activation of servants.
- **Bind Support policy** The Bind Support policy (a VisiBroker-specific policy) controls the registration of POAs and active objects with the VisiBroker osagent. If you have several thousand objects, it is not feasible to register all of them with the osagent. Instead, you can register the POA with the osagent. When a client request is made, the POA name and the object ID is included in the bind request so that the osagent can correctly forward the request.

The BindSupport policy can have the following values:

- **BY\_INSTANCE:** All active objects are registered with the osagent. The POA must also use the PERSISTENT and RETAIN policy with this value.
- **BY\_POA:** (Default) Only POAs are registered with the osagent. The POA must also use the PERSISTENT policy with this value.
- **NONE:** Neither POAs nor active objects are registered with the smart agent.

### Note

The `rootPoa` is created with NONE activation policy.

## Creating POAs

To implement objects using the POA, at least one POA object must exist on the server. To ensure that a POA exists, a `rootPoa` is provided during the VisiBroker ORB initialization. This POA uses the default POA policies described earlier in this section.

Once the `rootPoa` is obtained, you can create child POAs that implement a specific server-side policy set.

### POA naming convention

Each POA keeps track of its name and its full POA name (the full hierarchical path name.) The hierarchy is indicated by a slash (/). For example, `/A/B/C` means that POA C is a child of POA B, which in turn is a child of POA A. The first slash (see the previous example) indicates the `rootPoa`. If the `BindSupport:BY_POA` policy is set on POA C, then `/A/B/C` is registered with the `osagent` and the client binds with `/A/B/C`.

If your POA name contains escape characters or other delimiters, VisiBroker precedes these characters with a double back slash (\\) when recording the names internally. For example, if you have coded two POAs in the following hierarchy,

```
org.omg.PortableServer.POA myPOA1 = rootPoa.create_POA
("A/B",
 poaManager,
 policies);
org.omg.PortableServer.POA myPOA2 = myPOA1.create_POA
("\\t",
 poaManager,
 policies);
```

then the client would bind using:

```
org.omg.CORBA.Object manager =
((com.inprise.vbroker.orb.ORB) orb).
bind("/A\\B/B\\t",
 managerId,
 null,
 null);
```

### Obtaining the rootPoa

The following code sample illustrates how a server application can obtain its `rootPoa`.

```
// Initialize the ORB.
org.omg.CORBA.ORB orb = org.omg.CORBA.ORB.init(args,
null);
// get a reference to the rootPoa
org.omg.PortableServer.POA rootPoa =

POAHelper.narrow(orb.resolve_initial_references("RootPOA")
);
```

#### Note

The `resolve_initial_references` method returns a value of type `org.omg.CORBA.Object`. You are responsible for narrowing the returned

object reference to the desired type, which is `org.omg.PortableServer.POA` in the previous example.

## Setting the POA policies

Policies are not inherited from the parent POA. If you want a POA to have a specific characteristic, you must identify all the policies that are different from the default value. For more information about POA policies, see [“POA policies”](#).

```
org.omg.CORBA.Policy[] policies = {

    rootPoa.create_lifespan_policy(LifespanPolicyValue.PERSIST
    ENT)
};
```

## Creating and activating the POA

A POA is created using `create_POA` on its parent POA. You can name the POA anything you like; however, the name must be unique with respect to all other POAs with the same parent. If you attempt to give two POAs the same name, a CORBA exception (`AdapterAlreadyExists`) is raised.

To create a new POA, use `create_POA` as follows:

```
POA create_POA(POA_Name, POAManager, PolicyList);
```

The POA manager controls the state of the POA (for example, whether it is processing requests). If null is passed to `create_POA` as the POA manager name, a new POA manager object is created and associated with the POA. Typically, you will want to have the same POA manager for all POAs. For more information about the POA manager, see [“Managing POAs with the POA manager”](#).

POA managers (and POAs) are not automatically activated once created. Use `activate()` to activate the POA manager associated with your POA. The following code sample is an example of creating a POA.

```
// Create policies for our persistent POA
org.omg.CORBA.Policy[] policies = {

    rootPoa.create_lifespan_policy(LifespanPolicyValue.PERSIST
    ENT)};
// Create myPOA with the right policies
org.omg.PortableServer.POA myPOA =
    rootPoa.create_POA( "bank_agent_poa",
    rootPoa.the_POAManager(), policies );
```

## Activating objects

When CORBA objects are associated with an active servant, if the POA's Servant Retention Policy is `RETAIN`, the associated object ID is recorded in



the Active Object Map and the object is activated. Activation can occur in one of several ways:

<b>Activating objects explicitly</b>	The server application itself explicitly activates objects by calling <code>activate_object</code> or <code>activate_object_with_id</code> .
<b>Activating objects on demand</b>	The server application instructs the POA to activate objects through a user-supplied servant manager. The servant manager must first be registered with the POA through <code>set_servant_manager</code> .
<b>Activating objects implicitly</b>	The server activates objects solely by in response to certain operations. If a servant is not active, there is nothing a client can do to make it active (for example, requesting for an inactive object does not make it active.)
<b>Activating with the default servant</b>	The POA uses a single servant to implement all of its objects.

## Activating objects explicitly

By setting `IdAssignmentPolicy::SYSTEM_ID` on a POA, objects can be explicitly activated without having to specify an object ID. The server invokes `activate_object` on the POA which activates, assigns and returns an object ID for the object. This type of activation is most common for transient objects. No servant manager is required since neither the object nor the servant is needed for very long.

Objects can also be explicitly activated using object IDs. A common scenario is during server initialization where the user invokes `activate_object_with_id` to activate all the objects managed by the server. No servant manager is required since all the objects are already activated. If a request for a non-existent object is received, an `OBJECT_NOT_EXIST` exception is raised. This has obvious negative effects if your server manages large numbers of objects.

This code sample is an example of explicit activation using `activate_object_with_id`.

```
// Create the account manager servant.
Servant managerServant = new AccountManagerImpl(rootPoa);
// Activate the newly created servant.
testPoa.activate_object_with_id("BankManager".getBytes(),
managerServant);
// Activate the POAs
testPoa.the_POAManager().activate();
```

## Activating objects on demand

On-demand activation occurs when a client requests an object that does not have an associated servant. After receiving the request, the POA searches the Active Object Map for an active servant associated with the object ID. If none is found, the POA invokes `incarnate` on the servant manager which passes the object ID value to the servant manager. The servant manager can do one of three things:

- Find an appropriate servant which then performs the appropriate operation for the request.
- Raise an `OBJECT_NOT_EXIST` exception that is returned to the client.
- Forward the request to another object.

The POA policies determine any additional steps that may occur. For example, if `RequestProcessingPolicy.USE_SERVANT_MANAGER` and `ServantRetentionPolicy.RETAIN` are enabled, the Active Object Map is updated with the servant and object ID association.

An example of on-demand activation is shown below.

## Activating objects implicitly

A servant can be implicitly activated by certain operations if the POA has been created with `ImplicitActivationPolicy.IMPLICIT_ACTIVATION`, `IdAssignmentPolicy.SYSTEM_ID`, and `ServantRetentionPolicy.RETAIN`. Implicit activation can occur with:

- `POA.servant_to_reference` method
- `POA.servant_to_id` method
- `_this()` servant method

If the POA has `IdUniquenessPolicy.UNIQUE_ID` set, implicit activation can occur when any of the above operations are performed on an inactive servant.

If the POA has `IdUniquenessPolicy.MULTIPLE_ID` set, `servant_to_reference` and `servant_to_id` operations always perform implicit activation, even if the servant is already active.

## Activating with the default servant

Use the `RequestProcessing.USE_DEFAULT_SERVANT` policy to have the POA invoke the same servant no matter what the object ID is. This is useful when little data is associated with each object.

This is an example of activating all objects with the same servants

```
import org.omg.PortableServer.*;
public class Server {
    public static void main(String[] args) {
        try {
            // Initialize the ORB.
            org.omg.CORBA.ORB orb = org.omg.CORBA.ORB.init(args,null);
            // get a reference to the rootPoa
            POA rootPoa =
POAHelper.narrow(orb.resolve_initial_references("RootPOA"));
            // Create policies for our persistent POA
            org.omg.CORBA.Policy[] policies = {
                rootPoa.create_lifespan_policy(LifespanPolicyValue.PERSISTENT),
                rootPoa.create_request_processing_policy(
                    RequestProcessingPolicyValue.USE_DEFAULT_SERVANT
                )
            };
            rootPoa.create_id_uniqueness_policy(IdUniquenessPolicyValue.MULTIPLE_ID);
            // Create myPOA with the right policies
            POA myPOA = rootPoa.create_POA( "bank_default_servant_poa",
                rootPoa.the_POAManager(),
                policies );
            // Create the servant
            AccountManagerImpl managerServant = new AccountManagerImpl();
            // Set the default servant on our POA
            myPOA.set_servant(managerServant);
            org.omg.CORBA.Object ref;
```

```

// Activate the POA manager
rootPoa.the_POAManager().activate();
// Generate the reference and write it out. One for each Checking
//and Savings account types. Note that we are not creating any
// servants here and just manufacturing a reference which is not
// yet backed by a servant.
try {
    ref =
myPOA.create_reference_with_id("CheckingAccountManager".getBytes(),
    "IDL:Bank/AccountManager:1.0");
    // Write out checking object ID
    java.io.PrintWriter pw = new java.io.PrintWriter(
        new java.io.FileWriter("cref.dat") );
    pw.println(orb.object_to_string(ref));
    pw.close();
    ref =
myPOA.create_reference_with_id("SavingsAccountManager".getBytes(),
    "IDL:Bank/AccountManager:1.0");
    // Write out savings object ID
    pw = new java.io.PrintWriter( new java.io.FileWriter("sref.dat")
);
    pw.println(orb.object_to_string(ref));
    pw.close();
} catch ( java.io.IOException e ) {
    System.out.println("Error writing the IOR to file ");
    return;
}
System.out.println("Bank Manager is ready.");
// Wait for incoming requests
orb.run();
} catch (Exception e) {
    e.printStackTrace();
}
}
}

```

## Deactivating objects

A POA can remove a servant from its Active Object Map. This may occur, for example, as a form of garbage-collection scheme. When the servant is removed from the map, it is deactivated. You can deactivate an object using `deactivate_object()`. When an object is deactivated, it doesn't mean this object is lost forever. It can always be reactivated at a later time.

This is an example of deactivating an object:

```

import org.omg.PortableServer.*;
public class AccountManagerActivator extends _ServantActivatorLocalBase {
    public Servant incarnate (byte[] oid, POA adapter) throws ForwardRequest
    {
        Servant servant;
        String accountType = new String(oid);
        System.out.println("\nAccountManagerActivator.incarnate called
with ID = "
            + accountType + "\n");
        // Create Savings or Checking Servant based on AccountType
        if ( accountType.equalsIgnoreCase("SavingsAccountManager"))
            servant = (Servant )new SavingsAccountManagerImpl();
        else
            servant =(Servant)new CheckingAccountManagerImpl();
    }
}

```

```

        new DeactivateThread(oid, adapter).start();
        return servant;
    }
    public void etherealize (byte[] oid,
        POA adapter,
        Servant serv,
        boolean cleanup_in_progress,
        boolean remaining_activations) {

System.out.println("\nAccountManagerActivator.etherealize called
    with ID =" + new String(oid) + "\n");
    }
}
class DeactivateThread extends Thread {
    byte[] _oid;
    POA _adapter;
    public DeactivateThread(byte[] oid, POA adapter) {
        _oid = oid;
        _adapter = adapter;
    }
    public void run() {
        try {
            Thread.currentThread().sleep(15000);
            System.out.println("\nDeactivating the object with ID = " +
                new String(_oid) + "\n");
            _adapter.deactivate_object(_oid);
        } catch (Exception e) {
            e.printStackTrace();
        }
    }
}
}
}

```

## Using servants and servant managers

Servant managers perform two types of operations: find and return a servant, and deactivate a servant. They allow the POA to activate objects when a request for an inactive object is received. Servant managers are optional. For example, servant managers are not needed when your server loads all objects at startup. Servant managers may also inform clients to forward requests to another object using the `ForwardRequest` exception.

A servant is an active instance of an implementation. The POA maintains a map of the active servants and the object IDs of the servants. When a client request is received, the POA first checks this map to see if the object ID (embedded in the client request) has been recorded. If it exists, then the POA forwards the request to the servant. If the object ID is not found in the map, the servant manager is asked to locate and activate the appropriate servant. This is only an example scenario; the exact scenario depends on what POA policies you have in place.

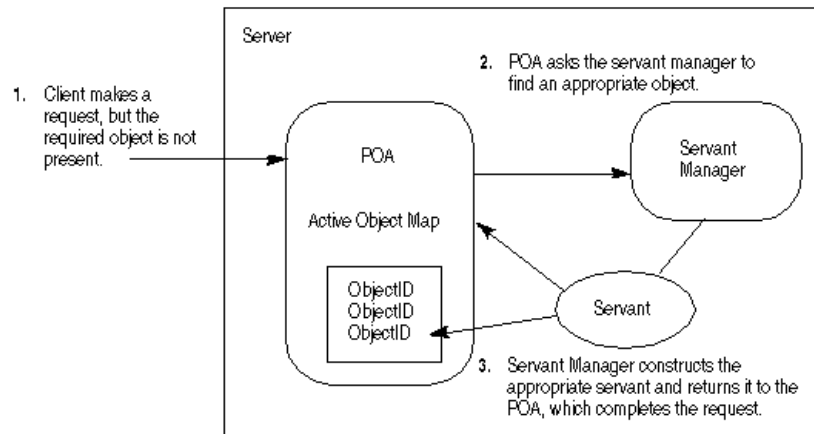
**Figure 6** Example servant manager function

There are two types of servant managers: *ServantActivator* and *ServantLocator*. The type of policy already in place determines which type of servant manager is used. For more information on POA policy, see "[POA policies](#)". Typically, a Servant Activator activates persistent objects and a Servant Locator activates transient objects.

To use servant managers, `RequestProcessingPolicy.USE_SERVANT_MANAGER` must be set as well as the policy which defines the type of servant manager (`ServantRetentionPolicy.RETAIN` for Servant Activator or `ServantRetentionPolicy.NON_RETAIN` for Servant Locator.)

## ServantActivators

ServantActivators are used when `ServantRetentionPolicy.RETAIN` and `RequestProcessingPolicy.USE_SERVANT_MANAGER` are set.

Servants activated by this type of servant manager are tracked in the Active Object Map.

The following events occur while processing requests using ServantActivators:

- 1 A client request is received (client request contains POA name, the object ID, and a few others.)
- 2 The POA first checks the active object map. If the object ID is found there, the operation is passed to the servant, and the response is returned to the client.
- 3 If the object ID is not found in the active object map, the POA invokes `incarnate` on a servant manager. `incarnate` passes the object ID and the POA in which the object is being activated.
- 4 The servant manager locates the appropriate servant.
- 5 The servant ID is entered into the active object map, and the response is returned to the client.

### Note

The `etherealize` and `incarnate` method implementations are user-supplied code.

At a later date, the servant can be deactivated. This may occur from several sources, including the `deactivate_object` operation, deactivation of the POA manager associated with that POA, and so forth. More information on deactivating objects is described in [“Deactivating objects”](#).

This code sample is an example of servant activator-type servant manager:

```
import org.omg.PortableServer.*;
public class Server {
    public static void main(String[] args) {
        try {
            // Initialize the ORB.
            org.omg.CORBA.ORB orb = org.omg.CORBA.FORB.init(args,null);
            // get a reference to the rootPoa
            POA rootPoa =
POAHelper.narrow(orb.resolve_initial_references("RootPOA"));
            // Create policies for our POA. We need persistence life span and
            // use servant manager request processing policies
            org.omg.CORBA.Policy[] policies = {
rootPoa.create_lifespan_policy(LifespanPolicyValue.PERSISTENT),
rootPoa.create_request_processing_policy(RequestProcessingPolicyValue.
            USE_SERVANT_MANAGER)
            };
            // Create myPOA with the right policies
            POA myPOA = rootPoa.create_POA( "bank_servant_activator_poa",
                rootPoa.the_POAManager(),
                policies );
            // Create the servant activator servant and get its reference
            ServantActivator sa = new AccountManagerActivator();
            // Set the servant activator on our POA
            myPOA.set_servant_manager(sa);
            org.omg.CORBA.Object ref;
            // Activate the POA manager
            rootPoa.the_POAManager().activate();
            // Generate the reference and write it out. One for each Checking
            and Savings
            // account types. Note that we are not creating any
            // servants here and just manufacturing a reference which is not
            // yet backed by a servant.
            try {
                ref =
myPOA.create_reference_with_id("CheckingAccountManager".getBytes(),
                "IDL:Bank/AccountManager:1.0");
                // Write out checking object ID
                java.io.PrintWriter pw =
                    new java.io.PrintWriter( new java.io.FileWriter
                        ("cref.dat" ) );
                pw.println(orb.object_to_string(ref));
                pw.close();
                ref =
myPOA.create_reference_with_id("SavingsAccountManager".getBytes(),
                "IDL:Bank/AccountManager:1.0");
                // Write out savings object ID
                pw = new java.io.PrintWriter( new java.io.FileWriter
                    ("sref.dat" ) );
                pw.println(orb.object_to_string(ref));
                pw.close();
            } catch ( java.io.IOException e ) {
                System.out.println("Error writing the IOR to file ");
                return;
            }
        }
    }
}
```

```

        System.out.println("Bank Manager is ready.");
        // Wait for incoming requests
        orb.run();
    } catch (Exception e) {
        e.printStackTrace();
    }
}
}

```

The servant manager for the servant activator example follows:

```

import org.omg.PortableServer.*;
public class AccountManagerActivator extends _ServantActivatorLocalBase {
    public Servant incarnate (byte[] oid, POA adapter) throws ForwardRequest
    {
        Servant servant;
        String accountType = new String(oid);
        System.out.println("\nAccountManagerActivator.incarnate called with ID
=
                                " + accountType + "\n");
        // Create Savings or Checking Servant based on AccountType
        if ( accountType.equalsIgnoreCase("SavingsAccountManager"))
            servant = (Servant )new SavingsAccountManagerImpl();
        else
            servant =(Servant)new CheckingAccountManagerImpl();
        new DeactivateThread(oid, adapter).start();
        return servant;
    }

    public void etherealize (byte[] oid,
        POA adapter,
        Servant serv,
        boolean cleanup_in_progress,
        boolean remaining_activations) {
        System.out.println("\nAccountManagerActivator.etherealize called
with ID = " + new String(oid) + "\n");
    }
}
class DeactivateThread extends Thread {
    byte[] _oid;
    POA _adapter;
    public DeactivateThread(byte[] oid, POA adapter) {
        _oid = oid;
        _adapter = adapter;
    }

    public void run() {

        try {
            Thread.currentThread().sleep(15000);
            System.out.println("\nDeactivating the object with ID =
" + new String(_oid) + "\n");
            _adapter.deactivate_object(_oid);
        } catch (Exception e) {
            e.printStackTrace();
        }
    }
}
}
}

```

## ServantLocators

In many situations, the POA's Active Object Map could become quite large and consume memory. To reduce memory consumption, a POA can be created with `RequestProcessingPolicy.USE_SERVANT_MANAGER` and `ServantRetentionPolicy.NON_RETAIN`, meaning that the servant-to-object association is not stored in the active object map. Since no association is stored, `ServantLocator` servant managers are invoked for each request.

The following events occur while processing requests using `ServantLocators`:

- 1 A client request, which contains the POA name and the object id, is received.
- 2 Since `ServantRetentionPolicy.NON_RETAIN` is used, the POA does not search the active object map for the object ID.
- 3 The POA invokes `preinvoke` on a servant manager. `preinvoke` passes the object ID, the POA in which the object is being activated, and a few other parameters.
- 4 The servant locator locates the appropriate servant.
- 5 The operation is performed on the servant and the response is returned to the client.
- 6 The POA invokes `postinvoke` on the servant manager.

### Note

The `preinvoke` and `postinvoke` methods are user-supplied code.

This example server code shows servant locator-type servant managers:

```
import org.omg.PortableServer.*;
public class Server {
    public static void main(String[] args) {
        try {
            // Initialize the ORB.
            org.omg.CORBA.ORB orb = org.omg.CORBA.ORB.init(args,null);
            // get a reference to the rootPoa
            POA rootPoa =

POAHelper.narrow(orb.resolve_initial_references("RootPOA"));
            // Create policies for our POA. We need persistence life span,
            // use servant manager request processing policies and non retain
            // retention policy. This non retain policy will let us use the
            // locator instead of servant activator
            org.omg.CORBA.Policy[] policies = {
                rootPoa.create_lifespan_policy(LifespanPolicyValue.PERSISTENT),
            rootPoa.create_servant_retention_policy(ServantRetentionPolicyValue.
                NON_RETAIN),
            rootPoa.create_request_processing_policy(RequestProcessingPolicyValue.
                USE_SERVANT_MANAGER)
        };
            // Create myPOA with the right policies
            POA myPOA = rootPoa.create_POA( "bank_servant_locator_poa",
                rootPoa.the_POAManager(),
                policies );
            // Create the servant locator servant and get its reference
            ServantLocator sl = new AccountManagerLocator();
            // Set the servant locator on our POA
```



```

myPOA.set_servant_manager(sl);
org.omg.CORBA.Object ref ;
// Activate the POA manager
rootPoa.the_POAManager().activate();
// Generate the reference and write it out. One for each Checking
// and Savings
// account types .Note that we are not creating any
// servants here and just manufacturing a reference which is not
// yet backed by a servant.
try {
    ref =
myPOA.create_reference_with_id("CheckingAccountManager".getBytes(),
    "IDL:Bank/AccountManager:1.0");
    // Write out checking object ID
    java.io.PrintWriter pw =
    new java.io.PrintWriter( new java.io.FileWriter("cref.dat") );
    pw.println(orb.object_to_string(ref));
    pw.close();
    ref =
    myPOA.create_reference_with_id("SavingsAccountManager".getBytes(),
    "IDL:Bank/AccountManager:1.0");
    // Write out savings object ID
pw = new java.io.PrintWriter( new java.io.FileWriter("sref.dat") );
    pw.println(orb.object_to_string(ref));
    pw.close();
} catch ( java.io.IOException e ) {
    System.out.println("Error writing the IOR to file ");
    return;
}
System.out.println("BankManager is ready.");
// Wait for incoming requests
orb.run();
} catch (Exception e) {
    e.printStackTrace();
}
}
}

```

The servant manager for this example follows:

```

import org.omg.PortableServer.*;
import org.omg.PortableServer.ServantLocatorPackage.CookieHolder;
public class AccountManagerLocator extends _ServantLocatorLocalBase {
    public Servant preinvoke (byte[] oid, POA adapter,
        java.lang.String operation,
        CookieHolder the_cookie) throws ForwardRequest {
        String accountType = new String(oid);
        System.out.println("\nAccountManagerLocator.preinvoke called
            with ID = " +
                accountType + "\n");
        if (
            accountType.equalsIgnoreCase("SavingsAccountManager"))
            return new SavingsAccountManagerImpl();
            return new CheckingAccountManagerImpl();
        }
        public void postinvoke (byte[] oid,
            POA adapter,
            java.lang.String operation,
            java.lang.Object the_cookie,
            Servant the_servant) {
            System.out.println("\

```

```
nAccountManagerLocator.postinvoke called with ID = " +
    new String(oid) + "\n");
    }
}
```

## Managing POAs with the POA manager

A POA manager controls the state of the POA (whether requests are queued or discarded), and can deactivate the POA. Each POA is associated with a POA manager object. A POA manager can control one or several POAs.

A POA manager is associated with a POA when the POA is created. You can specify the POA manager to use, or specify `null` to have a new POA Manager created.

The following is an example of naming the POA and its POA Manager:

```
POA myPOA = rootPoa.create_POA( "bank_agent_poa",
    rootPoa.the_POAManager(),
    policies );
POA myPOA = rootPoa.create_POA( "bank_agent_poa",
    null,
    policies );
```

A POA manager is “destroyed” when all its associated POAs are destroyed.

A POA manager can have the following four states:

- Holding
- Active
- Discarding
- Inactive

These states in turn determine the state of the POA. They are each described in detail in the following sections.

### Getting the current state

To get the current state of the POA manager, use

```
enum State{HOLDING, ACTIVE, DISCARDING, INACTIVE};
State get_state();
```

### Holding state

By default, when a POA manager is created, it is in the holding state. When the POA manager is in the holding state, the POA queues all incoming requests.

Requests that require an adapter activator are also queued when the POA manager is in the holding state.

To change the state of a POA manager to holding, use

```
void hold_requests (in boolean wait_for_completion)
    raises (AdapterInactive);
```

`wait_for_completion` is Boolean. If `FALSE`, this operation returns immediately after changing the state to holding. If `TRUE`, this operation returns only when all requests started prior to the state change have completed or when the POA manager is changed to a state other than

holding. `AdapterInactive` is the exception raised if the POA manager was in the inactive state prior to calling this operation.

### Note

POA managers in the inactive state cannot change to the holding state.

Any requests that have been queued but not yet started will continue to be queued during the holding state.

## Active state

When the POA manager is in the active state, its associated POAs process requests.

To change the POA manager to the active state, use

```
void activate()
    raises (AdapterInactive);
```

`AdapterInactive` is the exception raised if the POA manager was in the inactive state prior to calling this operation.

### Note

POA managers currently in the inactive state can not change to the active state.

## Discarding state

When the POA manager is in the discarding state, its associated POAs discard all requests that have not yet started. In addition, the adapter activators registered with the associated POAs are not called. This state is useful when the POA is receiving too many requests. You need to notify the client that their request has been discarded and to resend their request. There is no inherent behavior for determining if and when the POA is receiving too many requests. It is up to you to set up thread monitoring if so desired.

To change the POA manager to the discarding state, use

```
void discard_requests(in boolean wait_for_completion)
    raises (AdapterInactive);
```

The `wait_for_completion` option is Boolean. If `FALSE`, this operation returns immediately after changing the state to holding. If `TRUE`, this operation returns only when all requests started prior to the state change have completed or when the POA manager is changed to a state other than discarding. `AdapterInactive` is the exception raised if the POA manager was in the inactive state prior to calling this operation.

### Note

POA managers currently in the inactive state can not change to the discarding state.

## Inactive state

When the POA manager is in the inactive state, its associated POAs reject incoming requests. This state is used when the associated POAs are to be shut down.

### Note

POA managers in the inactive state cannot change to any other state.

To change the POA manager to the inactive state, use

```
void deactivate (in boolean etherealize_objects, in
boolean wait_for_completion)
    raises (AdapterInactive);
```

After the state changes, if `etherealize_objects` is `TRUE`, then all associated POAs that have `Servant RetentionPolicy.RETAIN` and `RequestProcessingPolicy.USE_SERVANT_MANAGER` set call `etherealize` on the servant manager for all active objects. If `etherealize_objects` is `FALSE`, then `etherealize` is not called. The `wait_for_completion` option is Boolean. If `FALSE`, this operation returns immediately after changing the state to inactive. If `TRUE`, this operation returns only when all requests started prior to the state change have completed or `etherealize` has been called on all associated POAs (that have `ServantRetentionPolicy.RETAIN` and `RequestProcessingPolicy.USE_SERVANT_MANAGER`). `AdapterInactive` is the exception raised if the POA manager was in the inactive state prior to calling this operation.

## Listening and Dispatching: Server Engines, Server Connection Managers, and their properties

### Note

Policies that cover listener and dispatcher features previously supported by the BOA are not supported by POAs. In order to provide these features, a VisiBroker-specific policy (`ServerEnginePolicy`) can be used.

VisiBroker provides a very flexible mechanism to define and tune endpoints for VisiBroker servers. An endpoint in this context is a destination for a communication channel for clients to communicate with servers. A *Server Engine* is a virtual abstraction for connection endpoint provided as a configurable set of properties.

A `ServerEngine` abstraction can provide control in terms of:

- types of connection resources
- connection management
- threading model and request dispatching

### Server Engine and POAs

A POA on Visibroker can have many-to-many relationship with a `ServerEngine`. A POA can be associated with many `ServerEngines` and vice-versa. The manifestation of this fact is that a POA, and hence the CORBA objects on the POA, can support multiple communication channels.

**Figure 7** Server engine overview

The simplest case is where POAs have their own unique single server engine. Here, requests for different POAs arrive on different ports. A POA can also have multiple server engines. In this scenario, a single POA supports requests coming from multiple input ports.

Notice that POAs can share server engines. When server engines are shared, the POAs listen to the same port. Even though the requests for (multiple) POAs arrive at the same port, they are dispatched correctly because of the POA name embedded in the request. This scenario occurs, for example, when you use a default server engine and create multiple POAs (without specifying a new server engine during the POA creation).

A Server Engine is identified by a name and is defined the first time its name is introduced. By default Visibroker defines three Server Engine names. They are:

- `iiop_tp`: TCP transport with thread pool dispatcher
- `iiop_ts`: TCP transport with thread per session dispatcher
- `iiop_tm`: TCP transport with main thread dispatcher

Two more Server Engines, `boa_tp` and `boa_ts`, are available for BOA backward compatibility.

### Associating a POA with a Server Engine

The default Server Engine associated with POA can be changed by using the property `vbroker.se.default`. For example, setting

```
vbroker.se.default=MySE
```

defines a new server engine with the name `MySE`. Root POA and all child POAs created will be associated with this Server Engine by default.

A POA can also be associated with a particular ServerEngine explicitly by using the `SERVER_ENGINE_POLICY_TYPE` POA policy. For example:

```
// create ServerEngine policy value
org.omg.CORBA.Any seAny = orb.create_any();
org.omg.CORBA.StringSequenceHelper.insert(seAny, new String[] {"MySE"});
org.omg.CORBA.Policy sePolicy =
orb.create_policy(com.inprise.vbroker.PortableServerExt.
SERVER_ENGINE_POLICY_TYPE.value, seAny);

// create POA policies
org.omg.CORBA.Policy[] policies = {
    rootPoa.create_lifespan_policy(LifeSpanPolicyValue.PERSISTENT),
    sePolicy
};
```

```
// create POA with policies
POA myPOA = rootPoa.create_POA("bank_se_policy_poa",
rootPoa.the_POAManager(), policies);
```

The POA has an IOR template, profiles for which, are obtained from the Server Engines associated with it.

If you don't specify a server engine policy, the POA assumes a server engine name of `iiop_tp` and uses the following default values:

```
vbroker.se.iiop_tp.host=null
vbroker.se.iiop_tp.proxyHost=null
vbroker.se.iiop_tp.scms=iiop_tp
```

To change the default server engine policy, enter its name using the `vbroker.se.default` property and define the values for all the components of the new server engine. For example:

```
vbroker.se.default=abc,def
vbroker.se.abc.host=cob
vbroker.se.abc.proxyHost=null
vbroker.se.abc.scms=cobscm1,cobscm2
vbroker.se.def.host=gob
vbroker.se.def.proxyHost=null
vbroker.se.def.scms=gobscm1
```

## Defining Hosts for Endpoints for the Server Engine

Since Server Engines help define a connection's endpoints, the following properties are provided to specify their hosts:

- `vbroker.se.<se-name>.host=<host-URL>`:  
`vbroker.se.mySE.host=host.microfocus.com`, for example.
- `vbroker.se.<se-name>.proxyHost=<proxy-host-URL-or-IP-address>`: `vbroker.se.mySE.proxyHost=proxy.microfocus.com`, for example.

The `proxyHost` property can also take an IP address as its value. Doing so replaces the default hostname in the IOR with this IP address.

The endpoint abstraction of ServerEngine is further fine-grained in terms of configurable set of entities referred to as Server Connection Managers (SCM). A ServerEngine can have multiple SCMs. SCMs are not shareable between ServerEngines. SCMs are also identified using a name and are defined for a ServerEngine using:

```
vbroker.se.<se-name>.scms=<SCM-name>[, <SCM-name>, ...]
```

### Note

The `iiop_tp` Server Engine has a SCM named `iiop_tp` created for it.

## Server Connection Managers

The Server Connection Manager defines the configurable components of an endpoint. Its responsibilities are connection resource management, listening for requests, and dispatching requests to its associated POA. Three logical entities, defined through property groups, are provided by the SCM to fulfill these responsibilities:

- Manager
- Listener
- Dispatcher

Each SCM has one Manager, Listener, and Dispatcher. All three, when defined, form a single endpoint definition allowing clients to contact servers.

## Manager

Manager is a set of properties defining the configurable portions of a connection resource. VisiBroker provides a manager of type Socket.

VisiBroker for Java only supports the Socket type, and a variation of the Socket type, Socket\_nio, that uses the Java NIO package. See section [“High scalability configuration for VisiBroker for Java \(using Java NIO\)”](#) for further details.

You can specify the maximum number of concurrent connections acceptable to the server endpoint using the `connectionMax` property:

```
vbroker.se.<se-name>.scm.<scm-name>.manager.connectionMax=<integer>
```

Setting `connectionMax` to 0 (zero) indicates that there is no restriction on the number of connections, which is the default setting.

You specify the maximum number of idle seconds using the `connectionMaxIdle` property:

```
vbroker.se.<se-name>.scm.<scm-name>.manager.connectionMaxIdle=<seconds>
```

Setting `connectionMaxIdle` to 0 (zero) indicates that there is no timeout, which is the default setting.

Garbage collection time is specified through the following property:

```
vbroker.orb.gcTimeout=<seconds>
```

A value of 0 (zero) means that the connection will never be garbage collected.

## Listener

The Listener is the SCM component that determines how and where the SCM listens for messages. Like the Manager, the Listener is also a set of properties. VisiBroker defines a IIOP listener for the TCP connections.

Since listeners are close to the actual underlying transport mechanism, their properties are not portable across listener types. Each listener type has its own set of properties, defined below.

### IIOP listener properties

IIOP listeners need to define a port and (if desired) a proxy port in conjunction with their hosts. These are set using the `port` and `proxyPort` properties, as follows:

```
vbroker.se.<se-name>.scm.<scm-name>.listener.port=<port>
vbroker.se.<se-name>.scm.<scm-name>.listener.proxyPort=<proxy-port>
```

### Note

If you do not set the port property (or set it to 0 [zero]), a random port will be selected. A 0 value for the `proxyPort` property means that the IOR will contain the actual port (defined by the `listener.port` property or selected by the system randomly). If it is not required to advertise the actual port, set the proxy port to a non-zero (positive) value.

VisiBroker additionally supports a property allowing you to specify your GIOP version:

```
vbroker.se.<se-name>.scm.<scm-name>.listener.giopVersion=<version>
```

## Dispatcher

The Dispatcher defines a set of properties that determine how the SCM dispatches requests to threads. Three types of dispatchers are provided: `ThreadPool`, `ThreadSession`, and `MainThread`. You set the dispatcher type with the `type` property:

```
vbroker.se.<se-name>.scm.<scm-name>.dispatcher.type=ThreadPool|ThreadSession|MainThread
```

Further control is provided through the SCM for the `ThreadPool` dispatcher type. The `ThreadPool` defines the minimum and maximum number of threads that can be created in the thread pool, as well as the maximum time in seconds after which an idled thread is destroyed. These values are controlled with the following properties:

```
vbroker.se.<se-name>.scm.<scm-name>.dispatcher.threadMin=<integer>
vbroker.se.<se-name>.scm.<scm-name>.dispatcher.threadMax=<integer>
vbroker.se.<se-name>.scm.<scm-name>.dispatcher.threadMaxIdle=<seconds>
```

The `ThreadPool` dispatcher allows a “cooling time” to be set. A thread is said to be “hot” when the GIOP connection being served is potentially readable, either upon creation of the connection or upon the arrival of a request. After the cooling time (in seconds), the thread can be returned to the thread pool.

VisiBroker for Java supports the cooling time property when configured to use the Java NIO package. See the section [“High scalability configuration for VisiBroker for Java \(using Java NIO\)”](#) for more information.

The following property is used to set the cooling time:

```
vbroker.se.<se-name>.scm.<scm-name>.dispatcher.coolingTime=<seconds>
```

## When to use these properties

There are many times where you need to change some of the server engine properties. The method for changing these properties depends on what you need. For example, suppose you want to change the port number. You could accomplish this by:

- Changing the default `listener.port` property
- Creating a new server engine

Changing the default `listener.port` property is the simplest method, but this affects all POAs that use the default server engine. This may or may not be what you want.

If you want to change the port number on a specific POA, then you'll have to create a new server engine, define the properties for this new server engine, and then reference the new server engine when creating the POA. The previous sections show how to update the server engine properties. The following code snippet shows how to define properties of a server engine and create a POA with a user-defined server engine policy:

```
// Server.java
import org.omg.PortableServer.*;
public class Server {
    public static void main(String[] args) {
```



```

try {

// Initialize the ORB.
org.omg.CORBA.ORB orb = org.omg.CORBA.ORB.init(args,null);
// Get property manager
com.inprise.vbroker.properties.PropertyManager pm =
    ((com.inprise.vbroker.ORB)orb).getPropertyManager();
pm.addProperty("vbroker.se.mySe.host", "");
pm.addProperty("vbroker.se.mySe.proxyHost", "");
pm.addProperty("vbroker.se.mySe.scms", "scmlist");
pm.addProperty("vbroker.se.mySe.scm.scmlist.manager.type", "Socket");
pm.addProperty("vbroker.se.mySe.scm.scmlist.manager.connectionMax",
    100);
pm.addProperty("vbroker.se.mySe.scm.scmlist.manager.connectionMaxIdle",
    300);
pm.addProperty("vbroker.se.mySe.scm.scmlist.listener.type", "IIOP");
pm.addProperty("vbroker.se.mySe.scm.scmlist.listener.port", 55000);
pm.addProperty("vbroker.se.mySe.scm.scmlist.listener.proxyPort", 0);
pm.addProperty("vbroker.se.mySe.scm.scmlist.dispatcher.type",
    "ThreadPool");
pm.addProperty("vbroker.se.mySe.scm.scmlist.listener.giopVersion",
    "1.2");
pm.addProperty("vbroker.se.mySe.scm.scmlist.dispatcher.threadMax",
    100);
pm.addProperty("vbroker.se.mySe.scm.scmlist.dispatcher.threadMin", 5);
pm.addProperty("vbroker.se.mySe.scm.scmlist.dispatcher.threadMaxIdle",
    300);
// get a reference to the root POA
POA rootPoa =
    POAHelper.narrow(orb.resolve_initial_references("RootPOA"));
// Create our server engine policy
org.omg.CORBA.Any seAny = orb.create_any();
org.omg.CORBA.StringSequenceHelper.insert(seAny, new String[]
    {"mySe"});
org.omg.CORBA.Policy sePolicy = orb.create_policy(
    com.inprise.vbroker.PortableServerExt.SERVER_ENGINE_POLICY_TYPE.
    value, seAny);
// Create policies for our persistent POA
org.omg.CORBA.Policy[] policies = {rootPoa.create_lifespan_policy
    (LifespanPolicyValue.PERSISTENT), sePolicy
};
// Create myPOA with the right policies
POA myPOA = rootPoa.create_POA("bank_se_policy_poa",
    rootPoa.the_POAManager(),
    policies );
// Create the servant
AccountManagerImpl managerServant = new AccountManagerImpl();
// Activate the servant
myPOA.activate_object_with_id("BankManager".getBytes(),
    managerServant);
// Obtaining the reference
org.omg.CORBA.Object ref = myPOA.servant_to_reference(managerServant);

// Now write out the IOR
try {
    java.io.PrintWriter pw =
        new java.io.PrintWriter( new java.io.FileWriter("ior.dat") );
    pw.println(orb.object_to_string(ref));
    pw.close();
} catch ( java.io.IOException e ) {

```

```

        System.out.println(<Default Para Font>"Error writing the IOR to
            file ior.dat");
        return;
    }
    // Activate the POA manager
    rootPoa.the_POAManager().activate();
    System.out.println(ref + " is ready.");
    // Wait for incoming requests
    orb.run();
    } catch (Exception e) {
        e.printStackTrace();
    }
}
}
}

```

## Adapter activators

Adapter activators are associated with POAs and provide the ability to create child POAs on-demand. This can be done during the `find_POA` operation, or when a request is received that names a specific child POA.

An adapter activator supplies a POA with the ability to create child POAs on demand, as a side-effect of receiving a request that names the child POA (or one of its children), or when `find_POA` is called with an `activate` parameter value of `TRUE`. An application server that creates all its needed POAs at the beginning of execution does not need to use or provide an adapter activator; it is necessary only for the case in which POAs need to be created during request processing.

While a request from the POA to an adapter activator is in progress, all requests to objects managed by the new POA (or any descendant POAs) will be queued. This serialization allows the adapter activator to complete any initialization of the new POA before requests are delivered to that POA.

For an example on using adapter activators, see the POA `adaptor_activator` example included with the product.

## Processing requests

Requests contain the Object ID of the target object and the POA that created the target object reference. When a client sends a request, the VisiBroker ORB first locates the appropriate server, or starts the server if needed. It then locates the appropriate POA within that server.

Once the VisiBroker ORB has located the appropriate POA, it delivers the request to that POA. How the request is processed at that point depends on the policies of the POA and the object's activation state. For information about object activation states, see ["Activating objects"](#).

- If the POA has `ServantRetentionPolicy.RETAIN`, the POA looks at the Active Object Map to locate a servant associated with the Object ID from the request. If a servant exists, the POA invokes the appropriate method on the servant.
- If the POA has `ServantRetentionPolicy.NON_RETAIN` or has `ServantRetentionPolicy.RETAIN` but did not find the appropriate servant, the following may take place:
  - If the POA has `RequestProcessingPolicy.USE_DEFAULT_SERVANT`, the POA invokes the appropriate method on the default servant.

- If the POA has `RequestProcessingPolicy.USE_SERVANT_MANAGER`, the POA invokes `incarnate` or `preinvoke` on the servant manager.
- If the POA has `RequestProcessingPolicy.USE_OBJECT_MAP_ONLY`, an exception is raised.

If a servant manager has been invoked but cannot incarnate the object, the servant manager can raise a `ForwardRequest` exception.



# Managing threads and connections

This section discusses the use of multiple threads in client programs and object implementations, and will help you understand the VisiBroker thread and connection model.

## Using threads

A *thread*, or a single sequential flow of control within a process, is also called a lightweight process that reduces overhead by sharing fundamental parts with other threads. Threads are lightweight so that there can be many of them present within a process.

Using multiple threads provides concurrency within an application and improves performance. Applications can be structured efficiently with threads servicing several independent computations simultaneously. For example, a database system may have many user interactions in progress while at the same time performing several file and network operations.

Although it is possible to write the software as one thread of control moving asynchronously from request to request, the code may be simplified by writing each request as a separate sequence, and letting the underlying system handle the synchronous interleaving of the different operations.

Multiple threads are useful when:

- There are groups of lengthy operations that do not necessarily depend on other processing (like painting a window, printing a document, responding to a mouse-click, calculating a spreadsheet column, signal handling).
- There will be few locks on data (the amount of shared data is identifiable and small).
- The task can be broken into various responsibilities. For example, one thread can handle the signals and another thread can handle the user interface.

Thread and connection management occurs within the scope of an entity known as a server engine. Several default server engines are created automatically by VisiBroker, which include thread pool engines for IIOP, for LIOP, and so forth. Additional server engines can be used and created in a VisiBroker server by applications. See the example in `<install_dir>/examples/vbroker/poa/server_engine_policy/Server.java`.

Server engines are created, configured, and used independently. The creation and configuration of one server engine does not affect other server engines in the same server. Usually, each server engine has one transport end point, called the *listen point/socket*.

The relationship between server engines and POAs is many-to-many. Each server engine can be used by multiple POAs, and each POA may also use multiple server engines.

Server engines can consist of multiple Server Connection Managers (SCMs). An SCM is composed of managers, listeners, and dispatchers. The properties of managers, listeners and dispatchers can be configured to determine how the SCM functions. These properties are discussed in [“Setting connection management properties”](#).

## Listener thread, dispatcher thread, and worker threads

Each server engine has a listener and a dispatcher thread. The listener thread is responsible for:

- Accepting new connections. Therefore, it listens on the listen end-point.
- Monitoring readability on idle GIOP connections.
- Updating the monitoring list.
- Idle connection garbage collection based on property settings.

The dispatcher determines which threads to send requests.

Each server engine uses a certain number of worker threads to receive and process requests. Different requests may be handled by different worker threads. For a given request, the request reading, processing (including server side interceptor intercepting), and replying are all handled by the same thread. The number of worker threads used by a server engine depends on:

- The thread model.
- The number of concurrent requests or connections.
- The property settings.

## Thread policies

The two major thread models supported by VisiBroker are the thread pool (also known as thread-per-request, or `TPOOL`) and thread-per-session (also known as thread-per-connection, or `TSESSION`). Single-thread and main-thread models are not discussed in this document. The thread pool and thread-per-session models differ in these fundamental ways:

- Situation in which they are created
- How simultaneous requests from the same client are handled
- When and how threads are released

The default thread policy is the thread pool. For information about setting thread-per-session or changing properties for the thread pool model, see [“Setting dispatch policies and properties”](#).

## Thread pool policy

When your server uses the thread pool policy, it defines the maximum number of threads that can be allocated to handle client requests. A worker thread is assigned for each client request, but only for the duration of that particular request. When a request is completed, the worker thread that was assigned to that request is placed into a pool of available threads so that it may be reassigned to process future requests from any of the clients.

Using this model, threads are allocated based on the amount of request traffic to the server object. This means that a highly active client that makes many requests to the server at the same time will be serviced by multiple threads, ensuring that the requests are quickly executed, while less active clients can share a single thread, and still have their requests immediately serviced. Additionally, the overhead associated with the creation and destruction of worker threads is reduced, because threads are

reused rather than destroyed, and can be assigned to multiple new connections.

VisiBroker conserves system resources by dynamically allocating the number of threads in the thread pool based on the number of concurrent client requests by default. If the client becomes very active, new threads are allocated to meet its needs. If threads remain inactive, VisiBroker releases them, only keeping enough threads to meet current client demand. This enables the optimal number of threads to be active in the server at all times.

The size of the thread pool grows based upon server activity and is fully configurable, either before or during execution, to meet the needs of specific distributed systems. With the thread pool model, you can configure the following:

- Maximum and minimum number of threads
- Maximum idle time

Each time a client request is received, an attempt is made to assign a thread from the thread pool to process the request. If this is the first client request and the pool is empty, a thread will be created. Likewise, if all threads are busy, a new thread will be created to service the request.

A server can define a maximum number of threads that can be allocated to handle client requests. If there are no threads available in the pool and the maximum number of threads have already been created, the request will block until a thread currently in use has been released back into the pool.

Thread pool is the default thread policy. You do not have to set up anything to define this environment. If you want to set properties for the thread pool, see ["Setting dispatch policies and properties"](#).

**Figure 8** Pool of threads is available

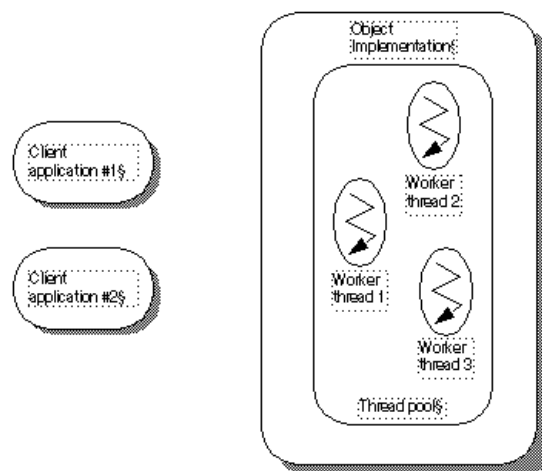

The figure above shows the object implementation using the thread pool policy. As the name implies, there is an available pool of worker threads in this policy.

**Figure 9** Client application #1 sends a request

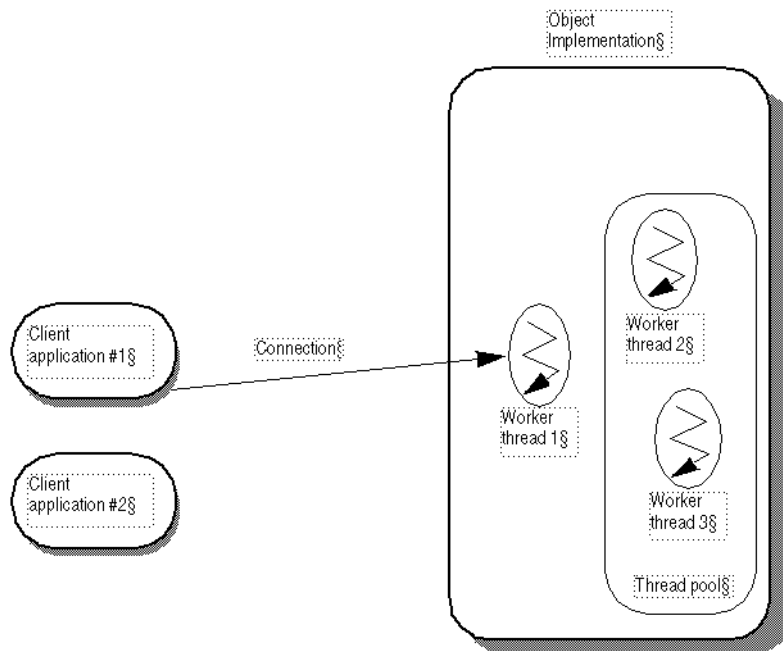

In the above figure, Client application #1 establishes a connection to the Object Implementation and a thread is created to handle requests. In the thread pool, there is one connection per client and one thread per connection. When a request comes in, a worker thread receives the request; that worker thread is no longer in the pool.

A worker thread is removed from the thread pool and is always listening for requests. When a request comes in, that worker thread reads in the request and dispatches the request to the appropriate object implementation. Prior to dispatching the request, the worker thread wakes up one other worker thread which then listens for the next request.

**Figure 10** Client application #2 sends a request

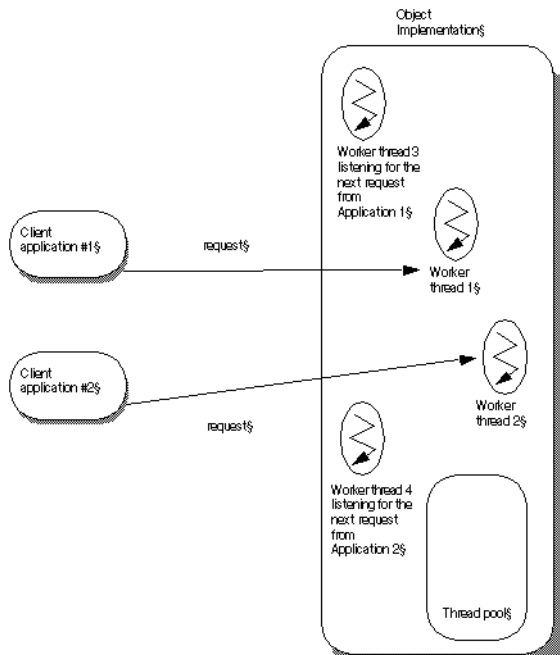



As the above figure shows, when Client application #2 establishes its own connection and sends a request, a second worker thread is created. Worker thread #3 is now listening for incoming requests.

**Figure 11** Client application #1 sends a second request

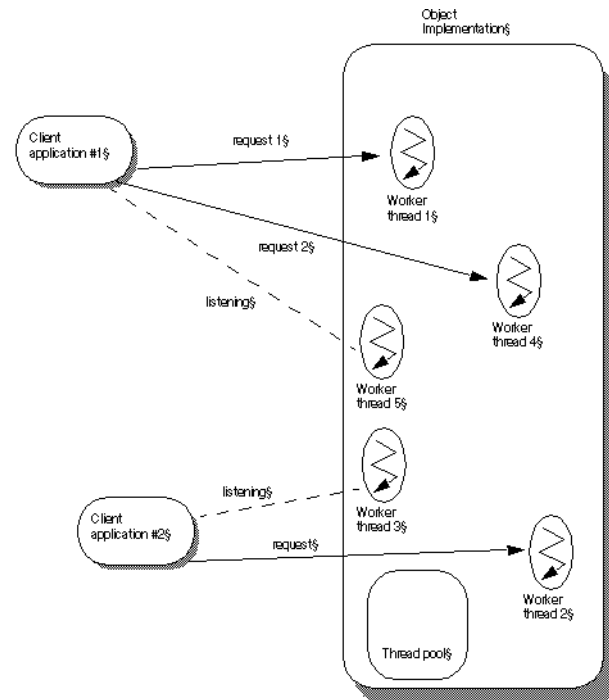

The above figure shows that when a second request comes in from Client application #1, it uses worker thread #4. Worker thread #5 is spawned to listen for new requests. If more requests came in from Client application #1, more threads would be assigned to handle them, each spawned after the listening thread receives a request. As worker threads complete their tasks, they are returned to the pool and become available to handle requests from any client.

## Thread-per-session policy

With the thread-per-session (`TSession`) policy, threading is driven by connections between the client and server processes. When your server selects the thread-per-session policy, a new thread is allocated each time a new client connects to a server. A thread is assigned to handle all the requests received from a particular client. Because of this, thread-per-session is also referred to as thread-per-connection. When the client disconnects from the server, the thread is destroyed. You may limit the maximum number of threads that can be allocated for client connections by setting the

`vbroker.se.iioptscm.iioptscm.manager.connectionMax` property.

**Figure 12** Object implementation using the thread-per-session policy

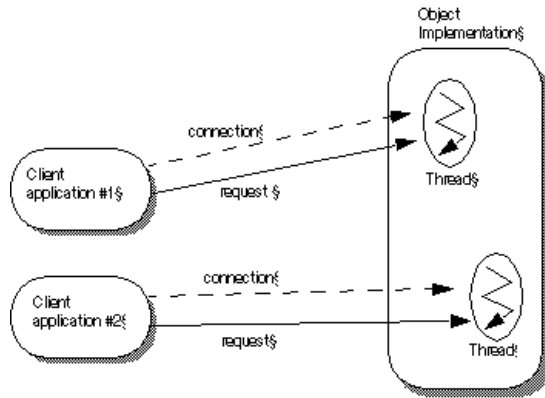

The above figure shows the use of the thread-per-session policy. The Client application #1 establishes a connection with the object implementation. A separate connection exists between Client application #2 and the object implementation. When a request comes in to the object implementation from Client application #1, a worker thread handles the request. When a request from Client application #2 comes in, a different worker thread is assigned to handle this request.

**Figure 13** Second request comes in from the same client

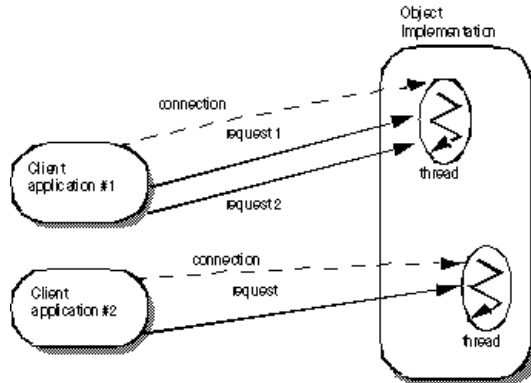

In the above figure, a second request has come in to the object implementation from Client application #1. The same thread that handles request 1 will handle request 2. The thread blocks request 2 until it completes request 1. (With thread-per-session, requests from the same Client are not handled in parallel.) When request 1 has completed, the thread can handle request 2 from Client application #1. Multiple requests may come in from Client application #1. They are handled in the order that they come in; no additional threads are assigned to Client application #1.

## Connection management

Overall, VisiBroker's connection management minimizes the number of client connections to the server. In other words there is only one connection per server process which is shared. All requests from a single client application are multiplexed over the same connection, even if they originate from different threads. Additionally, released client connections are recycled for subsequent reconnects to the same server, eliminating the need for clients to incur the overhead of new connections to the server.

In the following scenario, a client application is bound to two objects in the server process. Each `bind()` shares a common connection to the server process, even though the `bind()` is for a different object in the server process.

**Figure 14** Binding to two objects in the same server process

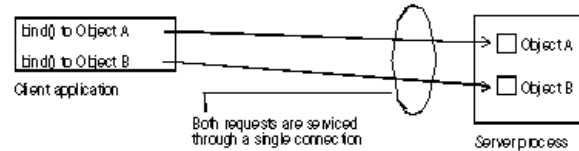

The following figure shows the connections for a client using multiple threads that has several threads bound to an object on the server.

**Figure 15** Binding to an object in a server process

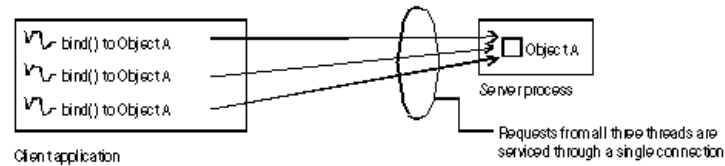

As the above figure shows, all invocations from all threads are serviced by the same connection. For that scenario, the most efficient multi threading model to use is the thread pool model. If the thread-per-session model is used in this scenario, only one thread on the server will be allocated to service all requests from all threads in the client application, which could easily result in poor performance.

The maximum number of connections to a server, or from a client, can be configured. Inactive connections will be recycled when the maximum is reached, ensuring resource conservation.

## PeerConnectionCurrent Interface

On the server side, a client's host and the port details are obtainable by the use of a `PeerConnectionCurrent` interface. The `PeerConnectionCurrent` interface is defined as follows:

```
public interface PeerConnectionCurrent {
    public abstract java.lang.String getPeerHost();
    public abstract int getPeerPort();
};
```

The reference to `PeerConnectionCurrent` interface is obtained by a call to `org.omg.CORBA.ORB.resolve_initial_references("PeerConnectionCurrent")`. If the client and server are collocated, a call to `getPeerHost` will return the localhost address and `getPeerPort` will return "0" (zero).

The host address is returned as a dotted IP address string. The precondition for the use of `PeerConnectionCurrent` is that it can only be used from inside a request's invocation context. Outside the invocation context, a call to `getPeerHost` and `getPeerPort` raises a `BAD_INV_ORDER` exception.

`PeerConnectionCurrent` can be called from inside in the following ways:

- 1 Method implementations
- 2 All `ServerRequestInterceptor` intercept points except for `postinvoke_postmarshal`

However, if the `ServantLocator` is being used, then the `PeerConnectionCurrent` cannot be called from within the `ServerRequestInterceptor` `receive_request_service_contexts` and the `ServantLocator` `preinvoke` methods. Otherwise, this will result with a `BAD_INV_ORDER` exception.

The following code illustrates the use of the `PeerConnectionCurrent`:

```
import com.inprise.vbroker.orb.PeerConnectionCurrent;
public class SomeServantImpl extends SomeServantPOA {
    public int method(String name) {
        .....
        // assuming "orb" is already initialized
        try {
            PeerConnectionCurrent conninfo=
                (PeerConnectionCurrent)
                orb.resolve_initial_references("PeerConnectionCurrent");
            System.out.println("Client's
            host="+conninfo.getPeerHost());
            System.out.println("Client's
            port="+conninfo.getPeerPort());
        }
        catch (Exception e) {
            e.printStackTrace();
        }
        .....
    }
}
```

## ServerEngines

Thread and connection management on the server side is performed by `ServerEngines`, which can consist of one or more `Server Connection Managers (SCMs)`. An `SCM` is a collection of properties of the manager, listener, and dispatcher.

Defining a `ServerEngine` consists of specifying a set of properties in a properties file. For example, if on UNIX the property file called `myprops.properties` is in home directory, the command line is

```
prompt> vbj -DORBpropStorage=~ /myprops.properties myServer
```

### ServerEngine properties

```
vbroker.se.<svr_eng_name>.scms=<svr_connection_mgr_name
1>,<svr_connection_mgr_name2>
```

The set of `Server Connection Managers` associated with a `ServerEngine` is defined by this property. The name specified in the above property as the `<svr_eng_name>` is the name of the `ServerEngine`. The `SCMs` listed here will be the list of `SCMs` for the associated server engine. `SCMs` cannot be shared between `ServerEngines`. However, `ServerEngines` can be shared by multiple `POAs`.

The other properties are

```
vbroker.se.<svr_eng_name>.host
```

The `host` property is the IP address for the server engine to listen for messages.

```
vbroker.se.<srvr_eng_name>.proxyHost
```

The `proxyHost` property specifies the proxy IP address to send to the client in the case where the server does not want to publish its real hostname.

## Setting dispatch policies and properties

Each POA in a multi-threaded object server can choose between two dispatch models: *thread-per-session* or *thread pool*. You choose a dispatch policy by setting the `dispatcher.type` property of the `ServerEngine`.

```
vbroker.se.<srvr_eng_name>.scm.<srvr_connection_mgr_name>
.dispatcher.type=
    ThreadPool
vbroker.se.<srvr_eng_name>.scm.<srvr_connection_mgr_name>
.dispatcher.type=
    ThreadSession
```

For more information about these properties see , [“Using POAs”](#) and the *VisiBroker Programmer's Reference*.

### Thread pool dispatch policy

`ThreadPool` (thread pooling) is the default dispatch policy when you create a POA without specifying the `ServerEnginePolicy`.

For `ThreadPool`, you can set the following properties:

- `vbroker.se.default.dispatcher.tp.threadMax`

This property sets a `TPool` server engine's maximum number of worker threads in the thread pool. The property can be set statically on server startup or dynamically reconfigured using the property API. For instance, the start up property

```
vbroker.se.default.dispatcher.tp.threadMax=32
```

or

```
vbroker.se.iiop_tp.scm.iioptp.dispatcher.threadMax=32
```

sets the initial maximum worker thread limitation to 32 for the default `TPool` server engine. The default value of this property is unlimited (0). If there are no threads available in the pool and the maximum number of threads have already been created, the request is blocked until a thread currently in use has been released back into the pool.

- `vbroker.se.default.dispatcher.tp.threadMin`

This property sets a TPool server engine's minimum number of worker threads in the thread pool. The property can be set statically on server startup or dynamically reconfigured using the property API. For instance, the start up property

```
vbroker.se.default.dispatcher.tp.threadMin=8
```

or

```
vbroker.se.iiop_tp.scm.iiop_tp.dispatcher.threadMin=8
```

sets the initial worker thread minimum number to 8 for the default TPool server engine. The default value of this property is 0 (no worker threads).
- `vbroker.se.default.dispatcher.tp.threadMaxIdle`

This property sets a TPool server engine's idle thread check interval. The property can be set statically on server startup or dynamically reconfigured using the property API. For instance, the start up property

```
vbroker.se.default.dispatcher.tp.threadMaxIdle=120
```

or

```
vbroker.se.iiop_tp.scm.iiop_tp.dispatcher.threadMaxIdle=120
```

sets the initial idle worker thread check interval to 120 seconds for the default TPool server engine. The default value of this property is 300 seconds. With this setting, the server engine will check the idle state of each worker thread every 120 seconds. If a worker thread has been idle across two consecutive checks, it will be recycled (terminated) at the second check. Therefore, the actual idle thread garbage collection time is between 120 to 240 seconds under the above setting, instead of exactly 120 seconds.
- `vbroker.se.default.dispatcher.tp.coolingTime`

The ThreadPooL dispatcher allows a "cooling time" to be set. A thread is said to be "hot" when the GIOP connection being served is potentially readable, either upon creation of the connection or upon the arrival of a request. After the cooling time (in seconds), the thread can be returned to the thread pool. The property can be set statically on server startup or dynamically reconfigured using the property API. For instance, the startup property

```
vbroker.se.default.dispatcher.tp.coolingTime=6
```

or

```
vbroker.se.iiop_tp.scm.iiop_tp.dispatcher.coolingTime=6
```

sets the initial cooling time to 6 seconds for the default engine (or the IIOP TPool server engine).

This property is applicable to VisiBroker for Java under certain conditions. See ["High scalability configuration for VisiBroker for Java \(using Java NIO\)"](#) for details. The default value of this property in VisiBroker for Java is 0 (zero), which implies that a GIOP connection being serviced ceases to be "hot" unless a new request is immediately available for servicing. It is important that the value of `coolingTime` is not altered unless tests have indicated that a non-default value is beneficial to the performance of the application.

**Note**

We recommend that you use the `vbroker.se.default.xxx.tp.xxx` property when `vbroker.se.default` is set to `iiop_tp`. When using with `ThreadSession`, we recommend that you use the `vbroker.se.iiop_ts.scm.iiop_ts.xxx` property.

**Thread-per-session dispatch policy**

When using the `ThreadSession` as the dispatcher type, you must set the `se.default` property to `iiop_ts`.

```
vbroker.se.default=iiop_ts
```

**Note**

In thread-per-session, there are no `threadMin`, `threadMax`, `threadMaxIdle`, and `coolingTime` dispatcher properties. Only the Connection and Manager properties are valid properties for `ThreadSession`.

**Coding considerations**

All code within a server that implements the VisiBroker ORB object must be thread-safe. You must take special care when accessing a system-wide resource within an object implementation. For example, many database access methods are not thread-safe. Before your object implementation attempts to access such a resource, it must first lock access to the resource using a synchronized block.

If serialized access to an object is required, you need to create the POA on which this object is activated with the `SINGLE_THREAD_MODEL` value for the `ThreadPolicy`.

**Setting connection management properties**

The following properties are used to configure connection management. Properties whose names start with `vbroker.se` are server-side properties. The client side properties have their names starting with `vbroker.ce`.

**Note**

The command line options for VisiBroker 3.x backward-compatibility are less obvious in terms of whether they are client-side or server-side. However, the connection and thread management options that start with the `-ORB` prefix set the client-side options whereas the options with the `-OA` prefix are used for the server-side options. There are no common properties which are used for both client-side and server-side thread and connection management.

The distinction between client and server vanishes if callback or bidirectional GIOP is used.

- `vbroker.se.default.socket.manager.connectionMax`

This property sets the maximum allowable client connections to a server engine. The property can be set statically on server startup or dynamically reconfigured using the property API. For instance, the start up property

```
-Dvbroker.se.default.socket.manager.connectionMax=128
```

or

```
-Dvbroker.se.iiop_tp.scm.iiop_tp.manager.connectionMax
=128
```

sets the initial maximum connection limitation on this server engine to 128. The default value of this property is unlimited (0 [zero]). When the server engine reaches this limitation, before accepting a new client connection, the server engine needs to reuse an idle connection. This is called connection swapping. When a new connection arrives at the server, it will try to detach the oldest unused connection. If all the connections are busy, the new connection will be dropped. The client may retry again until some timeout expires.

- `vbroker.se.default.socket.manager.connectionMaxIdle`

This property sets the maximum length of time an idle connection will remain open on a server engine. The property can be set statically on server startup or dynamically reconfigured using property API. For instance, the start up property

```
-Dvbroker.se.default.socket.manager.connectionMaxIdle
=300
```

or

```
-Dvbroker.se.iiop_tp.scm.iiop_tp.manager.
connectionMaxIdle=300
```

sets the initial idle connection maximum lifetime to 300 seconds. The default value of this property is 0 (unlimited). When a client connection has been idle longer than this value, it becomes a candidate for garbage collection.

- `vbroker.ce.iiop.ccm.connectionMax`

Specifies the maximum number of the total connections within a client. The default value of zero means that the client does not try to close any of the old active or cached connections. If a new client connection will result in exceeding the limit set by this property, VisiBroker for Java will try to release one of the cached connections. If there are no cached connections, it will try to close the oldest idle connection. If both of them fail, the CORBA: :NO\_RESOURCE exception will result.

## Valid values for applicable properties

The following properties have a fixed set or range of valid values:

- `vbroker.ce.iiop.ccm.type=Pool`

Currently, `Pool` is the only supported type.

In the following properties, `xxx` is the server engine name and `yyy` is the server connection manager name:

- `vbroker.se.xxx.scm.yyy.manager.type=Socket`

`Socket_nio` is the only other permissible value for this property.

- `vbroker.se.xxx.scm.yyy.listener.type=IIOP`

You can also use the value `SSL` for security.

- `vbroker.se.xxx.scm.yyy.dispatcher.type=ThreadPool`

The other possible values are `ThreadSession` and `MainThread`.

- `vbroker.se.xxx.scm.iiop_yyy.dispatcher.coolingTime`



The default value is 0 (zero) , and the maximum value is 10, so a value greater than 10 will be clamped to 10. In VisiBroker for Java, this property is applicable only if the Server Connection Manager has a manager type of `Socket_nio`. See ["High scalability configuration for VisiBroker for Java \(using Java NIO\)"](#) for details.

## Effects of property changes

The effect of a change in a property value depends on the actions associated with the properties. Most of the actions are directly or indirectly related to the utilization of system resources. The availability and restrictions of the system resources to the CORBA application vary depending on the system and the nature of the application.

For instance, decreasing the garbage collector timer may increase the system activities, as the garbage collector will run more frequently. On the other hand, increasing its value means the idle threads will remain in system unclaimed for longer periods of time.

## Dynamically alterable properties

The following properties can be changed dynamically and the effect will be immediate unless stated otherwise:

```

vbroker.ce.iiop.ccm.connectionCacheMax=5
vbroker.ce.iiop.ccm.connectionMax=0
vbroker.ce.iiop.ccm.connectionMaxIdle=360
vbroker.ce.iiop.connection.tcpNoDelay=false
vbroker.se.iiop_tp.scm.iiop_tp.manager.connectionMax=0
vbroker.se.iiop_tp.scm.iiop_tp.manager.connectionMaxIdle=0
vbroker.se.iiop_tp.scm.iiop_tp.dispatcher.threadMin=0
vbroker.se.iiop_tp.scm.iiop_tp.dispatcher.threadMax=100

```

The new dispatcher threadMax properties will be reflected after the next garbage collector run.

```

vbroker.se.iiop_tp.scm.iiop_tp.dispatcher.threadMaxIdle=300
vbroker.se.iiop_tp.scm.iiop_tp.dispatcher.coolingTime=3

```

## Determining whether property value changes take effect

For this purpose, the server manager needs to be enabled, using the property `vbroker.orb.enableServerManager=true`, and the properties can be obtained through the server manager query either through the Console or through a command-line utility.

## Impact of changing property values

It is very difficult to determine the impact of changing the value of a property to something other than the default. For thread and connection limits, the available system resources vary depending on the machine configuration and the number of other processes running. The setting of properties allows performance tuning for a given system.

## High scalability configuration for VisiBroker for Java (using Java NIO)

The Java NIO package, available in J2SE 1.4, allows servers to handle multiple connections efficiently, without having to dedicate a thread per connection. This allows servers to service a large number of client connections with fewer threads, translating to higher scalability. VisiBroker for Java servers can be configured to harness Java NIO technology. Servers using the ThreadPool policy can use Java NIO by setting the manager type to `Socket_nio` instead of `Socket`. For example,

```
vbroker.se.iiop_tp.scm.iiop_tp.manager.type=Socket_nio
```

This feature should be used in combination with the `threadMax` property, which is used to limit the number of threads in the thread pool that are available for dispatching requests (i.e., processing invocations). When the manager type is `Socket_nio`, the number of threads in the thread pool will not increase (beyond the number specified as `threadMax`) proportionate to the number of connections being serviced. This is possible because here the necessity to have a thread per connection does not exist.

Please note that the thread per connection model (which is the default for the VisiBroker for Java thread pool) is expected to outperform the NIO based model for servers where the number of connections is relatively small (i.e., not of the order of hundreds of connections). It is advisable to run tests to decide on the appropriate model given the typical load conditions for an application.

Servers using J2SE 1.4 or above will be able to use this feature. Currently, clients based on VisiBroker for Java do not benefit from the ORB's usage of Java NIO.

The `coolingTime` property is effective in VisiBroker for Java when NIO based dispatch is enabled. See [“Thread pool dispatch policy”](#) for details.

## Garbage collection

The VisiBroker for Java ORB performs automatic garbage collection of various resources other than the memory. The garbage collection of the memory is performed by the Java Virtual machine. Various properties are provided to control the garbage collection period. In addition, resources like threads and connections define timeout properties that control the collection of these resources.

### How ORB garbage collection works

The ORB garbage collector thread is a normal priority thread. After the expiration of timeout period (specified by the property `vbroker.orb.gcTimeout`), it wakes up and collects all the resources that are idle and no longer in use. Classes interested in getting collected register themselves with the garbage collector. Such classes are called *collectables*. Prominent examples of collectables are threads and connections. Other examples include timeout on various caches like GateKeeper's cache, for example. Most of the collectables null out or properly release the resources (such as closing the connection or terminating a thread's `run` method) held by them when they are collected. These resources are later reclaimed by the Java garbage collector.

## Note

The ORB garbage collector is an internal service and is not exposed to the user.

## Properties related to ORB garbage collection

The main property that controls the garbage collection period is `vbroker.orb.gcTimeout`. The timeout value is in seconds and the default value is 30 seconds.

Threads and connections define properties for *idle timeout*. For example, the thread pool dispatcher defines the following property:

```
vbroker.se.iiop_tp.scm.iiop_tp.dispatcher.threadMaxIdle
```

The value is in seconds and default value is 300 seconds after which the thread is removed from the thread pool. Similarly, the default Server Connection Manager (`iiop_tp`) defines the following idle timeout property for connections.

```
vbroker.se.iiop_tp.scm.iiop_tp.manager.connectionMaxIdle
```

The value is in seconds and default value is 0(zero) which means a connection never gets closed no matter how long it remains idle. However, if the connection gets dropped, the ORB removes all the references to it and its resources are later collected by Java garbage collector. The ORB garbage collector will only collect connections whose `connectionMaxIdle` property is set to a non-zero value.

The various timeout properties and the `vbroker.orb.gcTimeout` property have a subtle relationship. For example, suppose following properties are specified:

```
vbroker.orb.gcTimeout=10
vbroker.se.iiop_tp.scm.iiop_tp.dispatcher.threadMaxIdle=5
vbroker.se.iiop_tp.scm.iiop_tp.manager.connectionMaxIdle=5
```

Here the garbage collection timeout period is set to 10 seconds whereas thread and connection timeouts are 5 seconds. The figure below illustrates how these properties interact. Here we have shown a thread, T1, and a connection, C1, that have gone idle and are then collected.

## Note

Although the ORB garbage collector is shown here as running exactly after ten seconds, in practice this may not be true depending on when the JVM schedules the garbage collector (GC) thread.

**Figure 16** Collection of resources by ORB GC

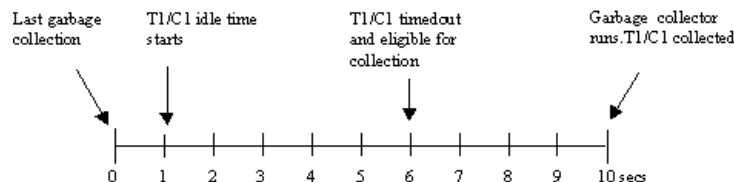

Even though T1 and C1 are eligible for collection, they are collected only when the ORB garbage collector runs. Until then they remain in the timed-out state.



# Using the tie mechanism

This section describes how the tie mechanism may be used to integrate existing Java code into a distributed object system. This section will enable you to create a delegation implementation or to provide implementation inheritance.

## How does the tie mechanism work?

Object implementation classes normally inherit from a servant class generated by the `idl2java` compiler. The servant class, in turn, inherits from `org.omg.PortableServer.Servant`. When it is not convenient or possible to alter existing classes to inherit from the VisiBroker servant class, the *tie* mechanism offers an attractive alternative.

The tie mechanism provides object servers with a *delegator implementation* class that inherits from `org.omg.PortableServer.Servant`. The delegator implementation does not provide any semantics of its own. The delegator implementation simply delegates every request it receives to the real implementation class, which can be implemented separately. The real implementation class is not required to inherit from `org.omg.PortableServer::Servant`.

With using the tie mechanism, two additional files are generated from the IDL compiler:

- `<interface_name>POATie` defers implementation of all IDL defined methods to a delegate. The delegate implements the interface `<interface_name>Operations`. Legacy implementations can be trivially extended to implement the operations interface and in turn delegate to the real implementation.
- `<interface_name>Operations` defines all of the methods that must be implemented by the object implementation. This interface acts as the delegate object for the associated `<interface_name>POATie` class when the tie mechanism is used.

## Example program

### Location of an example program using the tie mechanism

A version of the Bank example using the tie mechanism can be found in:

```
<install_dir>\vbroker\examples\basic\bank_tie
```

## Changes to the server class

The following code sample shows the modifications to the `Server` class. Note the extra step of creating an instance of `AccountManagerManagerPOATie`.

```
import org.omg.PortableServer.*;

public class Server {
    public static void main(String[] args) {
        try {
            // Initialize the ORB.
            org.omg.CORBA.ORB orb =
org.omg.CORBA.ORB.init(args,null);
            // get a reference to the root POA
            POA rootPoa = POAHelper.narrow(
                orb.resolve_initial_references("RootPOA"));
            // Create policies for our persistent POA
            org.omg.CORBA.Policy[] policies = {

rootPoa.create_lifespan_policy(LifespanPolicyValue.PERSIST
ENT)
            };
            // Create myPOA with the right policies
            POA myPOA = rootPoa.create_POA("bank_agent_poa",
                rootPoa.the_POAManager(), policies);
            // Create the tie which delegates to an instance of
AccountManagerImpl
            Bank.AccountManagerPOATie tie =
                new Bank.AccountManagerPOATie(new
AccountManagerImpl(rootPoa));
            // Decide on the ID for the servant
            byte[] managerId = "BankManager".getBytes();
            // Activate the servant with the ID on myPOA
            myPOA.activate_object_with_id(managerId, tie);
            // Activate the POA manager
            rootPoa.the_POAManager().activate();
            System.out.println("Server is ready.");
            // Wait for incoming requests
            orb.run();
        } catch (Exception e) {
            e.printStackTrace();
        }
    }
}
```

## Changes to the AccountManager

The changes made to the AccountManager class (in comparison with the Bank\_agent example) include:

- AccountManagerImpl no longer extends Bank.AccountManagerPOA.
- When a new Account is to be created, an AccountPOATie is also created and initialized.

```
import org.omg.PortableServer.*;
import java.util.*;

public class AccountManagerImpl implements
    Bank.AccountManagerOperations {
    public AccountManagerImpl(POA poa) {
        _accountPOA = poa;
    }
    public synchronized Bank.Account open(String name) {
        // Lookup the account in the account dictionary.
        Bank.Account account = (Bank.Account) _accounts.get(name);
        // If there was no account in the dictionary, create one.
        if (account == null) {
            // Make up the account's balance, between 0 and 1000 dollars.
            float balance = Math.abs(_random.nextInt()) % 100000 / 100f;
            // Create an account tie which delegate to an instance of AccountImpl
            Bank.AccountPOATie tie =
                new Bank.AccountPOATie(new AccountImpl(balance));
            try {
                // Activate it on the default POA which is root POA for
                // this servant
                account =
                    Bank.AccountHelper.narrow(_accountPOA.servant_to_reference(tie));
            }
            catch (Exception e) {
                e.printStackTrace();
            }
            // Print out the new account.
            System.out.println("Created " + name +
                "'s account: " + account);
            // Save the account in the account dictionary.
            _accounts.put(name, account);
        }
        // Return the account.
        return account;
    }
    private Dictionary _accounts = new Hashtable();
    private Random _random = new Random();
    private POA _accountPOA = null;
}
```

## Changes to the Account class

The changes made to the `Account` class (in comparison with the Bank example) are that it no longer extends `Bank.AccountPOA`.

```
// Server.java
public class AccountImpl implements Bank.AccountOperations
{
    public AccountImpl(float balance) {
        _balance = balance;
    }
    public float balance() {
        return _balance;
    }
    private float _balance;
}
```

## Building the tie example

The instructions described in [“Developing an example application with VisiBroker”](#) are also valid for building the tie example.



# Client basics

This section describes how client programs access and use distributed objects.

## Initializing the VisiBroker ORB

The Object Request Broker (ORB) provides a communication link between the client and the server. When a client makes a request, the VisiBroker ORB locates the object implementation, activates the object if necessary, delivers the request to the object, and returns the response to the client. The client is unaware whether the object is on the same machine or across a network.

You are advised to create only one single instance of the VisiBroker ORB per process as the ORB can use a significant amount of system resources.

Though much of the work done by the VisiBroker ORB is transparent to you, your client program must explicitly initialize the VisiBroker ORB. VisiBroker ORB options, described in “[Programmer tools for Java](#)”, can be specified as command-line arguments. To ensure these options take effect you will need to pass the supplied `args` argument to `ORB.init()`. The code samples below illustrate the VisiBroker ORB initialization.

```
public class Client {
    public static void main (String[] args) {
        org.omg.CORBA.ORB orb = org.omg.CORBA.ORB.init(args,
        null);
        ...
    }
}
```

## Binding to objects

A client program uses a remote object by obtaining a reference to the object. Object references are usually obtained using the `<interface>Helper`'s `bind()` method. The VisiBroker ORB hides most of the details involved with obtaining the object reference, such as locating the server that implements the object and establishing a connection to that server.

### Action performed during the bind process

When the server process starts, it performs `ORB.init()` and announces itself to Smart Agents on the network.

When your client program invokes the `bind()` method, the VisiBroker ORB performs several functions on behalf of your program.

- The VisiBroker ORB contacts the Smart Agent to locate an object implementation that offers the requested interface. If an object name is specified when `bind()` is invoked, that name is used to further qualify the directory service search. The Object Activation Daemon (OAD), described in “[Using the Object Activation Daemon \(OAD\)](#)”, may be involved in this process if the server object has been registered with the OAD.
- When an object implementation is located, the VisiBroker ORB attempts to establish a connection between the object implementation that was located and your client program.

- Once the connection is successfully established, the VisiBroker ORB will create a proxy object and return a reference to that object. The client will invoke methods on the proxy object which will, in turn, interact with the server object.

**Figure 17** Client interaction with the Smart Agent

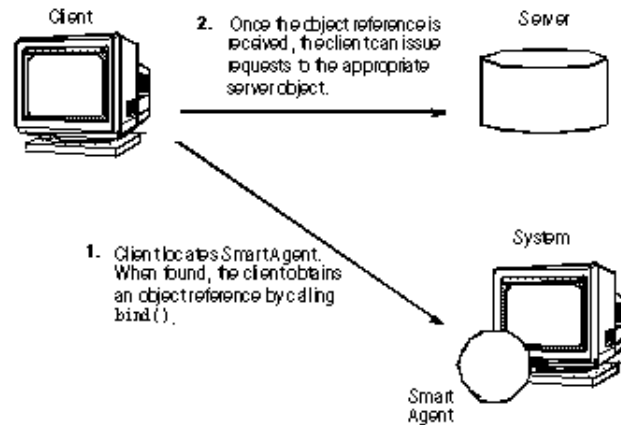

**Note**

Your client program will never invoke a constructor for the server class. Instead, an object reference is obtained by invoking the static `bind()` method.

```
Bank.AccountManager manager =
    Bank.AccountManagerHelper.bind(orb,
        "/bank_agent_poa",
        "BankManager".getBytes());
```

## Invoking operations on an object

Your client program uses an object reference to invoke an operation on an object or to reference data contained by the object. [“Manipulating object references”](#) describes the variety of ways that object references can be manipulated.

The following example shows how to invoke an operation using an object reference:

```
// Invoke the balance operation.
System.out.println("The balance in Account1: $" +
    account1.balance());
```

## Manipulating object references

The `bind()` method returns a reference to a CORBA object to your client program. Your client program can use the object reference to invoke operations on the object that have been defined in the object's IDL interface specification. In addition, there are methods that all VisiBroker ORB objects inherit from the class `org.omg.CORBA.Object` that you can use to manipulate the object.

## Converting a reference to a string

VisiBroker provides a `VisiBroker ORB` class with methods that allow you to convert an object reference to a string or convert a string back into an object reference. The CORBA specification refers to this process as stringification.

Method	Description
<code>object_to_string</code>	Converts an object reference to a string.
<code>string_to_object</code>	Converts a string to an object reference.

A client program can use the `object_to_string` method to convert an object reference to a string and pass it to another client program. The second client may then de-stringify the object reference, using the `string_to_object` method, and use the object reference without having to explicitly bind to the object.

### Note

Locally-scoped object references like the `VisiBroker ORB` or the `POA` cannot be stringified. If an attempt is made to do so, a `MARSHAL` exception is raised with the minor code 4.

## Obtaining object and interface names

The table below shows the methods provided by the `Object` class that you can use to obtain the interface and object names as well as the repository id associated with an object reference. The interface repository is discussed in [“Using Interface Repositories”](#).

### Note

When you invoke `bind()` without specifying an object name, invoking the `_object_name()` method with the resulting object reference returns `null`.

Method	Description
<code>_object_name</code>	Returns this object's name.
<code>_repository_id</code>	Returns the repository's type identifier.

## Determining the type of an object reference

You can check whether an object reference is of a particular type by using the `_is_a()` method. You must first obtain the repository id of the type you wish to check using the `_repository_id()` method. This method returns `true` if the object is either an instance of the type represented by `_repository_id()` or if it is a sub-type. The member function returns `false` if the object is not of the type specified. Note that this may require remote invocation to determine the type.

You cannot use the `instanceof` keyword to determine the runtime type.

You can use `_is_equivalent()` to check if two object references refer to the same object implementation. This method returns `true` if the object references are equivalent. It returns `false` if the object references are distinct, but it does not necessarily indicate that the object references are

two distinct objects. This is a lightweight method and does not involve actual communication with the server object.

Method	Description
<code>_is_a</code>	Determines if an object implements a specified interface.
<code>_is_equivalent</code>	Returns <code>true</code> if two objects refer to the same interface implementation.

## Determining the location and state of bound objects

Given a valid object reference, your client program can use `_is_bound()` to determine if the object is bound. The method returns `true` if the object is bound and returns `false` if the object is not bound.

The `_is_local()` method returns `true` if the client program and the object implementation reside within the same process or address space where the method is invoked.

The `_is_remote()` method returns `true` if the client program and the object implementation reside in different processes, which may or may not be located on the same host.

Method	Description
<code>_is_bound</code>	Determines if a connection is currently active for this object.
<code>_is_local</code>	Determines if this object is implemented in the local address space.
<code>_is_remote</code>	Determines if this object's implementation does not reside in the local address space.

## Narrowing object references

The process of converting an object reference's type from a general super-type to a more specific sub-type is called *narrowing*.

You cannot use the Java casting facilities for narrowing.

VisiBroker maintains a type graph for each object interface so that narrowing can be accomplished by using the object's `narrow()` method.

The IDL exception `CORBA::BAD_PARAM` is thrown if the narrow fails, because the object reference does not support the requested type.

```
public abstract class AccountManagerHelper {
    ...
    public static Bank.AccountManager
    narrow(org.omg.CORBA.Object object) {
        ...
    }
    ...
}
```

## Widening object references

Converting an object reference's type to a super-type is called *widening*. The code sample below shows an example of widening an `Account` pointer to an `Object` pointer. The pointer `acct` can be cast as an `Object` pointer because the `Account` class inherits from the `Object` class.

```
...
Account acct;
```

```

org.omg.CORBA.Object obj;
account = AccountHelper.bind();
obj = (org.omg.CORBA.Object) account;
...

```

## Using Quality of Service (QoS)

Quality of Service (QoS) uses policies to define and manage the connection between your client applications and the servers to which they connect.

### Understanding Quality of Service (QoS)

QoS policy management is performed through operations accessible in the following contexts:

- The VisiBroker ORB level policies are handled by a locality constrained `PolicyManager`, through which you can set `Policies` and view the current `Policy` overrides. Policies set at the VisiBroker ORB level override system defaults.
- Thread level policies are set through `PolicyCurrent`, which contains operations for viewing and setting `Policy` overrides at the thread level. Policies set at the thread level override system defaults and values set at the VisiBroker ORB level.
- Object level policies can be applied by accessing the base `Object` interface's quality of service operations. Policies applied at the Object level override system defaults and values set in at the VisiBroker ORB or thread level.

#### Note

The QoS policies installed at the ORB level will only affect those objects on which no method is called before installing the policies, for example a `non_existent` call internally makes a call on a server object. If ORB level QoS policies are installed after the `non_existent` call, then the policies do not apply.

### Policy overrides and effective policies

The effective policy is the policy that would be applied to a request after all applicable policy overrides have been applied. The effective policy is determined by comparing the `Policy` as specified by the IOR with the effective override. The effective `Policy` is the intersection of the values allowed by the effective override and the IOR-specified `Policy`. If the intersection is empty a `org.omg.CORBA.INV_POLICY` exception is raised.

### QoS interfaces

The following interfaces are used to get and set QoS policies.

#### **org.omg.CORBA.Object**

Contains the following methods used to get the effective policy and get or set the policy override.

- `_get_policy` returns the effective policy for an object reference.
- `_set_policy_override` returns a new object reference with the requested list of `Policy` overrides at the object level.

## **com.inprise.vbroker.CORBA.Object**

In order to use this interface, you must cast `org.omg.CORBA.Object` to `com.inprise.vbroker.CORBA.Object`. Because this interface is derived from `org.omg.CORBA.Object`, the following methods are available in addition to the ones defined in `org.omg.CORBA.Object`.

- `_get_client_policy` returns the effective `Policy` for the object reference without doing the intersection with the server-side policies. The effective override is obtained by checking the specified overrides in first the object level, then at the thread level, and finally at the VisiBroker ORB level. If no overrides are specified for the requested `PolicyType` the system default value for `PolicyType` is used.
- `_get_policy_overrides` returns a list of `Policy` overrides of the specified policy types set at the object level. If the specified sequence is empty, all overrides at the object level will be returned. If no `PolicyTypes` are overridden at the object level, an empty sequence is returned.
- `_validate_connection` returns a boolean value based on whether the current effective policies for the object will allow an invocation to be made. If the object reference is not bound, a binding will occur. If the object reference is already bound, but current policy overrides have changed, or the binding is no longer valid, a rebind will be attempted, regardless of the setting of the `RebindPolicy` overrides. A `false` return value occurs if the current effective policies would raise an `INV_POLICY` exception. If the current effective policies are incompatible, a sequence of type `PolicyList` is returned listing the incompatible policies.

## **org.omg.CORBA.PolicyManager**

The `PolicyManager` is an interface that provides methods for getting and setting `Policy` overrides for the VisiBroker ORB level.

- `get_policy_overrides` returns a `PolicyList` sequence of all the overridden policies for the requested `PolicyTypes`. If the specified sequence is empty, all `Policy` overrides at the current context level will be returned. If none of the requested `PolicyTypes` are overridden at the target `PolicyManager`, an empty sequence is returned.
- `set_policy_overrides` modifies the current set of overrides with the requested list of `Policy` overrides. The first input parameter, `policies`, is a sequence of references to `Policy` objects. The second parameter, `set_add`, of type `org.omg.CORBA.SetOverrideType` indicates whether these policies should be added onto any other overrides that already exist in the `PolicyManager` using `ADD_OVERRIDE`, or they should be added to a `PolicyManager` that doesn't contain any overrides using `SET_OVERRIDES`. Calling `set_policy_overrides` with an empty sequence of policies and a `SET_OVERRIDES` mode removes all overrides from a `PolicyManager`. Should you attempt to override policies that do not apply to your client, `org.omg.CORBA.NO_PERMISSION` will be raised. If the request would cause the specified `PolicyManager` to be in an inconsistent state, no policies are changed or added, and an `InvalidPolicies` exception is raised.

## **org.omg.CORBA.PolicyCurrent**

The `PolicyCurrent` interface derives from `PolicyManager` without adding new methods. It provides access to the policies overridden at the thread level. A reference to a thread's `PolicyCurrent` is obtained by invoking `org.omg.CORBA.ORB.resolve_initial_references` and specifying an identifier of `PolicyCurrent`.

## **com.inprise.vbroker.QoSExt.DeferBindPolicy**

The `DeferBindPolicy` determines if the VisiBroker ORB will attempt to contact the remote object when it is first created, or to delay this contact until the first invocation is made. The values of `DeferBindPolicy` are `true` and `false`. If `DeferBindPolicy` is set to `true` all binds will be deferred until the first invocation of a binding instance. The default value is `false`.

If you create a client object, and `DeferBindPolicy` is set to `true`, you may delay the server startup until the first invocation. This option existed before as an option to the `Bind` method on the generated helper classes.

The code sample below illustrates an example for creating a `DeferBindPolicy` and setting the policy on the VisiBroker ORB.

```
// Initialize the flag and the references
boolean deferMode = true;
Any policyValue= orb.create_any();
policyValue.insert_boolean(deferMode);

Policy policies =
    orb.create_policy(DEFER_BIND_POLICY_TYPE.value,
policyValue);

// Get a reference to the thread manager
PolicyManager orbManager =
    PolicyManagerHelper.narrow(
        orb.resolve_initial_references("ORBPolicyManager"));

// Set the policy on the ORB level
orbManager.set_policy_overrides(new Policy[] {policies},
    SetOverrideType.SET_OVERRIDE);

// Get the binding method
byte[] managerId = "BankManager".getBytes();
Bank.AccountManager manager =
    Bank.AccountManagerHelper.bind(orb, "/qos_poa",
managerId);
```

## **com.inprise.vbroker.QoSExt. ExclusiveConnectionPolicy**

The `ExclusiveConnectionPolicy` is a VisiBroker-specific policy that gives you the ability to establish an exclusive (non-shared) connection to the specified server object. You assign this policy a boolean value of `true` or `false`. If the policy is `true`, connections to the server object are exclusive. If the policy is `false`, existing connections are reused if possible and a new connection is opened only if reuse is not possible. The default value is `false`.

This policy provides the same capabilities as were provided by `Object._clone()` in VisiBroker 3.x.

An example of how to establish exclusive and non-exclusive connections is provided in the `CloneClient.java` example which can be found in:

```
<install_dir>\examples\vbroker\QoS_policies\qos\
```

## **com.inprise.vbroker.QoSExt.RelativeConnectionTimeoutPolicy**

The `RelativeConnectionTimeoutPolicy` indicates a timeout after which attempts to connect to an object using one of the available endpoints is aborted. The timeout situation could happen in various circumstances, for example with objects protected by firewalls, where HTTP tunneling is the only way to connect to the object.

The following code examples illustrates how to create `RelativeConnectionTimeoutPolicy`:

```
Any connTimeoutPolicyValue = orb.create_any();
    // Input is in 100s of Nanoseconds.
    // To specify a value of 20 seconds, use 20 * 10^7
    nanoseconds as input

    int connTimeout = 20;

    connTimeoutPolicyValue.insert_ulonglong(connTimeout *
10000000);
    org.omg.CORBA.Policy ctoPolicy =

orb.create_policyRELATIVE_CONN_TIMEOUT_POLICY_TYPE.value,
    connTimeoutPolicyValue);
    PolicyManager orbManager = PolicyManagerHelper.narrow (
    orb.resolve_initial_references("ORBPolicyManager"));

orbManager.set_policy_overrides(new Policy[] \{ctoPolicy\
},
    SetOverrideType.SET_OVERRIDE);
```

## **org.omg.Messaging.RebindPolicy**

`RebindPolicy` is used to indicate whether the ORB may transparently rebind once successfully bound to a target. An object reference is considered bound once it is in a state where a `LocateRequest` message would result in a `LocateReply` message with status `OBJECT_HERE`. `RebindPolicy` accepts values of type `org.omg.Messaging.RebindMode` and are set only on the client side. It can have one of six values that determine the behavior in the case of a disconnection, an object forwarding request, or an object failure after an object reference is bound. The supported values are:

- `org.omg.Messaging.TRANSPARENT` allows the VisiBroker ORB to silently handle object-forwarding and necessary reconnections during the course of making a remote request. The code sample below illustrates an example to create a `RebindPolicy` of type `TRANSPARENT` and sets the policy on the VisiBroker ORB, thread, and object levels.
- `org.omg.Messaging.NO_REBIND` allows the VisiBroker ORB to silently handle reopening of closed connections while making a remote request, but prevents any transparent object-forwarding that would cause a change in client-visible effective QoS policies. When `RebindMode` is set to `NO_REBIND`, only explicit rebind is allowed.
- `org.omg.Messaging.NO_RECONNECT` prevents the VisiBroker ORB from silently handling object-forwards or the reopening of closed connections. You must explicitly rebind and reconnect when `RebindMode` is set to `NO_RECONNECT`.
- `com.inprise.vbroker.QoSExt.VB_TRANSPARENT` is the default policy. It extends the functionality of `TRANSPARENT` by allowing transparent



rebinding with both implicit and explicit binding. VB\_TRANSPARENT is designed to be compatible with the object failover implementation in VisiBroker 3.x.

- `com.inprise.vbroker.QoSExt.VB_NOTIFY_REBIND` throws an exception if a rebind is necessary. The client catches this exception, and binds on the second invocation. If a client has received a `CloseConnection` message before, it will also reestablish the closed connection.
- `com.inprise.vbroker.QoSExt.VB_NO_REBIND` does not enable failover. It only allows the client VisiBroker ORB to reopen a closed connection to the same server; it does not allow object forwarding of any kind.

### Note

Be aware that if the effective policy for your client is VB\_TRANSPARENT and your client is working with servers that hold state data, VB\_TRANSPARENT could connect the client to a new server without the client being aware of the change of server, and in that case any state data held by the original server will be lost.

### Note

If the Client has set `RebindPolicy` and the `RebindMode` is anything other than the default (VB\_TRANSPARENT), then the `RebindPolicy` is propagated in a special `ServiceContext` as per the CORBA specification. The propagation of the `ServiceContext` occurs only when the client invokes the server through a `GateKeeper` or a `RequestAgent`. This propagation does not occur in a normal Client/Server scenario.

The following table describes the behavior of the different `RebindMode` types.

RebindMode type	Reestablish closed connection to the same object?	Allow object forwarding?	Object failover?
NO_RECONNECT	No, throws REBIND exception.	No, throws REBIND exception.	No
NO_REBIND	Yes	Yes, if policies match. No, throws REBIND exception.	No
TRANSPARENT	Yes	Yes	No
VB_NO_REBIND	Yes	No, throws REBIND exception.	No
VB_NOTIFY_REBIND	No, throws exception.	Yes	Yes. VB_NOTIFY_REBIND throws an exception after failure detection, and then tries a failover on subsequent requests.
VB_TRANSPARENT	Yes	Yes	Yes, transparently.

The appropriate CORBA exception will be thrown in the case of a communication problem or an object failure.

The following example creates a `RebindPolicy` of type `TRANSPARENT` and sets the policy on the `VisiBroker ORB`, thread, and object levels.

```

Any policyValue= orb.create_any();
RebindModeHelper.insert(policyValue,
    org.omg.Messaging.TRANSPARENT.value);
Policy myRebindPolicy =
orb.create_policy(REBIND_POLICY_TYPE.value,
    policyValue);
//get a reference to the ORB policy manager
org.omg.CORBA.PolicyManager manager;
try {
    manager =
PolicyManagerHelper.narrow(orb.resolve_initial_references(
    "ORBPolicyManager"));
}
catch(org.omg.CORBA.ORBPackage.InvalidName e) {}
//get a reference to the per-thread manager
org.omg.CORBA.PolicyManager current;
try {
    current =

PolicyManagerHelper.narrow(orb.resolve_initial_references
    ("PolicyCurrent"));
}
catch(org.omg.CORBA.ORBPackage.InvalidName e) {}
//set the policy on the orb level
try{
    manager.set_policy_overrides(myRebindPolicy,
        SetOverrideType.SET_OVERRIDE);
}
catch (InvalidPolicies e){}
// set the policy on the Thread level
try {
    current.set_policy_overrides(myRebindPolicy,
        SetOverrideType.SET_OVERRIDE);
}
catch (InvalidPolicies e){}
//set the policy on the object level:
org.omg.CORBA.Object oldObjectReference=bind(...);
org.omg.CORBA.Object
newObjectReference=oldObjectReference._set_policy_override
    (myRebindPolicy, SetOverrideType.SET_OVERRIDE);

```

For more information on QoS policies and types, see the `Messaging` section of the `CORBA` specification.

### **org.omg.CORBA.Messaging.RelativeRequestTimeout Policy**

The `RelativeRequestTimeoutPolicy` indicates the relative amount of time which a `Request` or its responding `Reply` may be delivered. After this amount of time, the `Request` is canceled. This policy applies to both synchronous and asynchronous invocations. Assuming the request completes within the specified timeout, the `Reply` will never be discarded due to timeout. The timeout value is specified in hundreds of nanoseconds. This policy is only effective on established connections, and is not applicable to establishing a connection.

The following code illustrates how to create `RelativeRequestTimeoutPolicy`:

```
// Specify the request timeout in 100s of Nanosecs.
// To set a timeout of 20 secs, set 20 * 10^7
int reqTimeout = 20;
Any policyValue = orb.create_any();
policyValue.insert_ulonglong(reqTimeout * 10000000);
// Create Policy
org.omg.CORBA.Policy reqPolicy = orb.create_policy(
    RELATIVE_REQ_TIMEOUT_POLICY_TYPE.value,
policyValue);
    PolicyManager orbManager = PolicyManagerHelper.narrow(
orb.resolve_initial_references("ORBPolicyManager"));
    orbManager.set_policy_overrides(new Policy[]
{reqPolicy},
SetOverrideType.SET_OVERRIDE);
```

### **org.omg.CORBA.Messaging.RelativeRoundTripTimeoutPolicy**

The `RelativeRoundTripTimeoutPolicy` specifies the relative amount of time for which a Request or its corresponding Reply may be delivered. If a response has not yet been delivered after this amount of time, the Request is canceled. Also, if a Request had already been delivered and a Reply is returned from the target, the Reply is discarded after this amount of time. This policy applies to both synchronous and asynchronous invocations. Assuming the request completes within the specified timeout, the Reply will never be discarded due to timeout. The timeout value is specified in hundreds of nanoseconds.

This policy is also effective in the initial establishment of a connection.

The following code illustrates how to create `RelativeRoundTripTimeoutPolicy`:

```
// Specify the round-trip timeout in 100s of Nanoseconds
// To set a timeout of 50 secs, set 50 * 10^7
int rttTimeout = 50;
Any policyValue = orb.create_any();
policyValue.insert_ulonglong(rttTimeout * 10000000);
//Create the RelativeRoundTripTimeoutPolicy and set it
at ORB level
    org.omg.CORBA.Policy rttPolicy = orb.create_policy(
RELATIVE_RT_TIMEOUT_POLICY_TYPE.value, policyValue);
    PolicyManager orbManager = PolicyManagerHelper.narrow(
orb.resolve_initial_references("ORBPolicyManager"));
    orbManager.set_policy_overrides(new Policy[]
{rttPolicy},
SetOverrideType.SET_OVERRIDE);
```

### **org.omg.CORBA.Messaging.SyncScopePolicy**

The `SyncScopePolicy` defines the level of synchronization for a request with respect to the target. Values of type `SyncScope` are used in conjunction with a `SyncScopePolicy` to control the behavior of one-way operations.

The default `SyncScopePolicy` is `SYNC_WITH_TRANSPORT`. To perform one-way operations via the OAD, you must use `SyncScopePolicy=SYNC_WITH_SERVER`. Valid values for `SyncScopePolicy` are defined by the OMG.

### Note

Applications must explicitly set an `VisiBroker` ORB-level `SyncScopePolicy` to ensure portability across `VisiBroker` ORB implementations. When instances of `SyncScopePolicy` are created, a value of type `Messaging::SyncScope` is passed to `CORBA::ORB::create_policy`. This policy is only applicable as a client-side override.

## Exceptions

Exception	Description
<code>org.omg.CORBA.INV_POLICY</code>	Raised when there is an incompatibility between <code>Policy</code> overrides.
<code>org.omg.CORBA.REBIND</code>	Raised when the <code>RebindPolicy</code> has a value of <code>NO_REBIND</code> , <code>NO_RECONNECT</code> , or <code>VB_NO_REBIND</code> and an invocation on a bound object references results in an object-forward or location-forward message.
<code>org.omg.CORBA.PolicyError</code>	Raised when the requested <code>Policy</code> is not supported.
<code>org.omg.CORBA.InvalidPolicies</code>	Raised when an operation is passed a <code>PolicyList</code> sequence. The exception body contains the policies from the sequence that are not valid, either because the policies are already overridden within the current scope, or are not valid in conjunction with other requested policies.

## Code Set support

`VisiBroker` supports Code Set Negotiation that allows applications to agree on a common Code Set when marshaling `char` or `wchar` IDL data types. A Code Set is a collection of unambiguous rules that establishes a character set and the one-to-one relationship between each character of the set and its bit representation or numeric value.

### Types of Code Sets

Code sets can differ in their classification. Some language environments distinguish between byte-oriented and “wide characters”. The byte-oriented characters are encoded in one or more 8-bit bytes. ASCII (as used for western European languages like English) is an example of a typical single-byte encoding. A typical multi-byte encoding which uses from one to three 8-bit bytes for each character is `euCJP` (Extended UNIX Code—Japan, packed format), used for Japanese workstations. Although byte-oriented Code Sets such as UTF-8 uses one to six 8-bit bytes for a character representation, the CORBA specification mandates that for `char` data the size limit is still one byte and that `char []` should be used if a representation uses more than one byte.

Wide characters are a fixed 16 or 32 bits long, and are used for languages like Chinese and Japanese, where the number of combinations offered by 8 bits is insufficient and a fixed-width encoding is needed. A typical example is Unicode (a “universal” character set defined by The Unicode Consortium). An extended encoding scheme for Unicode characters is UTF-16 (UCS Transformation Format, 16-bit representations).

## Native Code Set

A native code set is the code set which a client or a server uses to communicate with its ORB. There might be separate native code sets for `char` and `wchar` data.

## Conversion Code Set (CCS)

This is the set of target code sets for which an ORB can convert all encodings between the native code set and that target code set. For each code set in this CCS, the ORB maintains appropriate translation or conversion procedures and advertises the ability to use that code set for transmitted data in addition to the native code set.

## Transmission Code Set (TCS)

A transmission code set is the commonly agreed upon encoding used for character data transfer between a client's ORB and a server's ORB. There are two transmission code sets established per session between a client and its server, one for `char` data (TCS-C) and the other for `wchar` data (TCS-W).

## Code Set Negotiation

The client-side ORB determines a server's native and conversion code sets from an IOR multi-component profile structure, simultaneously determining a client's native and conversion code sets. From this information, the client-side ORB chooses `char` and `wchar` transmission code sets (TCS-C and TCS-W). For both requests and replies, the `char` TCS-C determines the encoding of `char` and `string` data, and the `wchar` TCS-W determines the encoding of `wchar` and `wstring` data.

## Supported Code Sets

VisiBroker supports the following code sets:

- For IDL `char` data types the native Code Set is ISO 8859-1 (Latin-1) and the conversion Code supported is UTF-8.
- For IDL `wchar` data types the native Code Set is UTF-16 and there is no Conversion Code Set.

# Deploying client-only applications using Client Run-time

In many application deployments you need only a client run-time rather than a full-sized ORB implementation. If the application is a pure client and has no server-side functionality, such as POA creation and object activation, VisiBroker provides a client run-time library for such scenarios. The VisiBroker Client Run-time has a smaller memory footprint compared to the full VisiBroker implementation. The client run-time is provided as a Java archive (`vbjclientorb.jar`) file which is installed under the `/lib` directory in the VisiBroker installation.

### Note

The Client Run-time does not support full ORB functionality.

The following features are supported by the VisiBroker client run-time library:

- Client-side functionality such as invoking operations on remote servers and services is provided. Applications using the client runtime can still make use of services like Interface Repository, Naming Service, RequestAgent (only Polling mode), etc. They can also make use of GateKeeper for firewall traversal, and they can invoke operations on servers that are registered with Object Activation Daemon (OAD). They are also able to use OSAgent for locating servers.
- Client-side interceptors such as Bind Interceptor, and Request Interceptors (both VisiBroker 4x and Portable Interceptors) can be used.
- VisiSecure client-side functionality is also available. However, additional security JAR files are required to be included in the classpath (see instruction in ["Usage"](#) below).

The following features are not supported by the VisiBroker client runtime library:

- Any server-side functionality, such as POA creation or object activation. Using `resolve_initial_references("RootPOA")` is not allowed.
- Notification, Event Service, and callback mode of Request Agent.
- Location Service.
- Any type of server-side interceptors, such as POALifeCycleInterceptor, Request Interceptor (both VisiBroker 4x and Portable Interceptor), and IOR interceptors.

## Usage

To make use of `vbjclientorb.jar`, modify `<install_dir>/bin/vbj.config` to configure an `addpath` entry for `vbjclientorb.jar`. To make this change, replace the following line in the `vbj.config` file:

```
addpath $var(defaultJarPath)/vbjorb.jar
```

with:

```
addpath $var(defaultJarPath)/vbjclientorb.jar
```

When using VisiSecure in client applications, `vbsec.jar`, `sunjce_provider.jar`, `local_policy.jar`, `US_export_policy.jar` should also be present in the classpath. If JDK 1.3.1 is used, the JAR files `jsse.jar`, `jcrt.jar`, `jnet.jar`, `jaas.jar`, and `jce1_2_1.jar` should also be present in the classpath, in addition to the JARs mentioned previously.

### Note

If a particular feature is not supported by the client runtime (`vbjclientorb.jar`), at runtime the following standard error message is printed out along with the `ClassNotFoundException` or `NoClassDefFound` exception:

```
*****Client runtime does not support full ORB functionality*****
```

# Using IDL

This section describes how to use the CORBA interface description language (IDL).

## Introduction to IDL

The Interface Definition Language (IDL) is a *descriptive language* (not a programming language) to describe the interfaces being implemented by the remote objects. Within IDL, you define the name of the interface, the names of each of the attributes and methods, and so forth. Once you've created the IDL file, you can use an IDL compiler to generate the client stub file and the server skeleton file in the Java programming language.

For more information see “Using IDL”.

The OMG has defined specifications for such language mapping. Information about the language mapping is not covered in this manual since VisiBroker adheres to the specification set forth by OMG. If you need more information about language mapping, see the OMG web site at <http://www.omg.org>.

### Note

The CORBA 3.0 formal specification can be found at [http://www.omg.org/technology/documents/vault.htm#CORBA\\_IIOP](http://www.omg.org/technology/documents/vault.htm#CORBA_IIOP).

Discussions on the IDL can be quite extensive. Because VisiBroker adheres to the specification defined by OMG, you can visit the OMG site for more information about IDL.

## How the IDL compiler generates code

You use the Interface Definition Language (IDL) to define the object interfaces that client programs may use. The `idl2java` compiler uses your interface definition to generate code.

### Example IDL specification

Your interface definition defines the name of the object as well as all of the methods the object offers. Each method specifies the parameters that will be passed to the method, their type, and whether they are for input or output or both. The IDL sample below shows an IDL specification for an object named `example`. The `example` object has only one method, `op1`.

```
// IDL specification for the example object
interface example {
    long op1(in char x, out short y);
};
```

## Looking at the generated code

The IDL compiler generates several files from the above Example IDL specification.

- `_exampleStub.java` is the stub code for the example object on the client side.
- `example.java` is the example interface declaration.
- `exampleHelper.java` declares the `exampleHelper` class, which defines helpful utility functions and support functions for the `example` interface.
- `exampleHolder.java` declares the `exampleHolder` class, which provides a holder for passing out and inout parameters.
- `exampleOperations.java` defines the methods in the example interface and is used both on the client and the server side. It also works together with the tie classes to provide the tie mechanism.
- `examplePOA.java` contains the skeleton code (implementation base code) for the example object on the server side.
- `examplePOATie.java` contains the class used to implement the example object on the server side using the tie mechanism.

## **`_<interface_name>Stub.java`**

For each user-defined type, a stub class is created by the `idl2java` compiler. This is the class which is instantiated on the client side which implements the `<interface_name>` interface.

```
public class exampleStub extends
com.inprise.vbroker.CORBA.portable.ObjectImpl
implements example {
    final public static java.lang.Class _opsClass =
exampleOperations.class;
    public java.lang.String[] ids () {
        ...
    }
    public int op1 (char x, org.omg.CORBA.ShortHolder y) {
        ...
    }
}
```

## **`<interface_name>.java`**

The `<interface_name>.java` file is the Java interface generated for each IDL interface. This is the direct mapping of the IDL interface definition to the appropriate Java interface. This interface is then implemented by both the client and server skeleton.

```
public interface example extends
com.inprise.vbroker.CORBA.Object,
exampleOperations,
org.omg.CORBA.portable.IDLEntity {
}
```

## **`<interface_name>Helper.java`**

For each user-defined type, a helper class is created by `idl2java`. The Helper class is an abstract class with various static methods for the generated Java interface.

```
public final class exampleHelper {
    public static example narrow (final org.omg.CORBA.Object
obj) {
        ...
    }
}
```



```

public static example unchecked_narrow
(org.omg.CORBA.Object obj) {
    ...
}
public static example bind (org.omg.CORBA.ORB orb) {
    ...
}
public static example bind (org.omg.CORBA.ORB orb,
    java.lang.String name) {
    ...
}
public static example bind (org.omg.CORBA.ORB orb,
    java.lang.String name,
    java.lang.String host,
    com.inprise.vbroker.CORBA.BindOptions _options) {
    ...
}
public static example bind (org.omg.CORBA.ORB orb,
    java.lang.String
    fullPoaName,
    byte[] oid) {
    ...
}
public static example bind (org.omg.CORBA.ORB orb,
    java.lang.String fullPoaName, byte[] oid,
    java.lang.String host,
    com.inprise.vbroker.CORBA.BindOptions _options) {
    ...
}
public java.lang.Object read_Object (final
org.omg.CORBA.portable.
    InputStream istream) {
    ...
}
public void write_Object (
    final org.omg.CORBA.portable.OutputStream ostream,
    final java.lang.Object obj) {
    ...
}
public java.lang.String get_id () {
    ...
}
public org.omg.CORBA.TypeCode get_type () {
    ...
}
public static example read (
    final org.omg.CORBA.portable.InputStream _input) {
    ...
}
public static void write (
    final org.omg.CORBA.portable.OutputStream _output,
    final example value) {
    ...
}
public static void insert (
    final org.omg.CORBA.Any any, final example value) {
    ...
}
public static example extract (final org.omg.CORBA.Any
any) {
    ...
}
public static org.omg.CORBA.TypeCode type () {
    ...
}
}

```

```

    public static java.lang.String id () {
        ...
    }
}

```

## <interface\_name>Holder.java

For each user-defined type, a holder class is created by the idl2java compiler. It provides a class for an object which wraps objects which support the <interface\_name> interface when passed as out and inout parameters.

```

public final class exampleHolder
    implements org.omg.CORBA.portable.Streamable {
    public foo.example value;
    public exampleHolder () {
    }
    public exampleHolder (final foo.example _vis_value) {
        ...
    }
    public void _read (final
org.omg.CORBA.portable.InputStream input) {
        ...
    }
    public void _write (final
org.omg.CORBA.portable.OutputStream output) {
        ...
    }
    public org.omg.CORBA.TypeCode _type () {
        ...
    }
}

```

## <interface\_name>Operations.java

For each user-defined type, an operations class is created by the idl2java compiler which contains all the methods defined in the IDL declaration.

```

public interface exampleOperations {
    public int op1(char x, org.omg.CORBA.ShortHolder y);
}

```

## <interface\_name>POA.java

The <interface\_name>POA.java file is the server-side skeleton for the interface. It unmarshals in parameters and passes them in an upcall to the object implementation and marshals back the return value and any out parameters.

```
public abstract class examplePOA
    extends org.omg.PortableServer.Servant
    implements org.omg.CORBA.portable.InvokeHandler,
exampleOperations {
    public example _this () {
        ...
    }
    public example _this (org.omg.CORBA.ORB orb) {
        ...
    }
    public java.lang.String[] _all_interfaces (
        final org.omg.PortableServer.POA poa,
        ...
    )
    public org.omg.CORBA.portable.OutputStream _invoke
(java.lang.String opName,
    org.omg.CORBA.portable.InputStream _input,
    org.omg.CORBA.portable.ResponseHandler handler) {
        ...
    }
    public static org.omg.CORBA.portable.OutputStream
_invoke (exampleOperations _self,
    int _method_id, org.omg.CORBA.portable.InputStream
_input,
    org.omg.CORBA.portable.ResponseHandler _handler) {
        ...
    }
}
```

## <interface\_name>POATie.java

The <interface\_name>POATie.java file is a delegator implementation for the <interface\_name> interface. Each instance of the tie class must be initialized with an instance of an implementation class that implements the <interface\_name>Operations class to which it delegates every operation.

```
public class examplePOATie extends examplePOA {
    public examplePOATie (final exampleOperations _delegate)
    {
        ...
    }
    public examplePOATie (final exampleOperations _delegate,
        final org.omg.PortableServer.POA _poa) {
        ...
    }
    public exampleOperations _delegate () {
        ...
    }
    public void _delegate (final exampleOperations delegate)
    {
        ...
    }
    public org.omg.PortableServer.POA _default_POA () {
```

```

    }
    ...
    public int op1 (char x, org.omg.CORBA.ShortHolder y) {
    }
    ...
}

```

## Defining interface attributes in IDL

In addition to operations, an interface specification can also define attributes as part of the interface. By default, all attributes are *read-write* and the IDL compiler will generate two methods, one to set the attribute's value, and one to get the attribute's value. You can also specify *read-only* attributes, for which only the reader method is generated.

The IDL sample below shows an IDL specification that defines two attributes, one read-write and one read-only.

```

interface Test {
    attribute long count;
    readonly attribute string name;
};

```

The following code sample shows the operations class generated for the interface declared in the IDL.

```

public interface TestOperations {
    public int count ();
    public void count (int count);
    public java.lang.String name ();
}

```

## Specifying one-way methods with no return value

IDL allows you to specify operations that have no return value, called *one-way* methods. These operations may only have input parameters. When a *oneway* method is invoked, a request is sent to the server, but there is no confirmation from the object implementation that the request was actually received.

VisiBroker uses TCP/IP for connecting clients to servers. This provides reliable delivery of all packets so the client can be sure the request will be delivered to the server, as long as the server remains available. Still, the client has no way of knowing if the request was actually processed by the object implementation itself.

### Note

One-way operations cannot raise exceptions or return values.

```

interface oneway_example {
    oneway void set_value(in long val);
};

```

## Specifying an interface in IDL that inherits from another interface

IDL allows you to specify an interface that inherits from another interface. The classes generated by the IDL compiler will reflect the inheritance relationship. All methods, data type definitions, constants and enumerations declared by the parent interface will be visible to the derived interface.

```
interface parent {
    void operation1();
};
interface child : parent {
    ...
    long operation2(in short s);
};
```

The code sample below shows the code that is generated from the interface specification shown above.

```
public interface parentOperations {
    public void operation1 ();
}
public interface childOperations extends parentOperations
{
    public int operation2 (short s);
}
public interface parent
    extends com.inprise.vbroker.CORBA.Object,
    parentOperations,
    org.omg.CORBA.portable.IDLEntity {
}
public interface child extends childOperations,
    Baz.parent,
    org.omg.CORBA.portable.IDLEntity {
}
```



# Using the Smart Agent

This section describes the Smart Agent (`osagent`), which client programs register with in order to find object implementations. It explains how to configure your own VisiBroker ORB domain, connect Smart Agents on different local networks, and migrate objects from one host to another.

## What is the Smart Agent?

VisiBroker's Smart Agent (`osagent`) is a dynamic, distributed directory service that provides facilities used by both client programs and object implementations. A Smart Agent must be started on at least one host within your local network. When your client program invokes `bind()` on an object, the Smart Agent is automatically consulted. The Smart Agent locates the specified implementation so that a connection can be established between the client and the implementation. The communication with the Smart Agent is completely transparent to the client program.

If the `PERSISTENT` policy is set on the POA, and `activate_object_with_id` is used, the Smart Agent registers the object or implementation so that it can be used by client programs. When an object or implementation is deactivated, the Smart Agent removes it from the list of available objects. Like client programs, the communication with the Smart Agent is completely transparent to the object implementation. For more information about POAs, see [“Using POAs”](#).

## Best practices for Smart Agent configuration and synchronization

While the Smart Agent imposes no hard limits on the numbers and types of objects that it can support, there are reasonable best practices that can be followed when incorporating it into a larger architecture.

The Smart Agent is designed to be a lightweight directory service with a flat, simple namespace, which can support a small number of well known objects within a local network.

Since all objects' registered services are stored in memory, scalability cannot be optimized and be fault tolerant at the same time. Applications should use well known objects to bootstrap to other distributed services so as not to rely on the Smart Agent for all directory needs. If a heavy services lookup load is necessary, it is advisable to use the VisiBroker Naming Service (VisiNaming). VisiNaming provides persistent storage capability and cluster load balancing whereas the Smart Agent only provides a simple round robin on a per `osagent` basis. Due to the in-memory design of the Smart Agent, if it is terminated by a proper shutdown or an abnormal termination, it does not failover to another Smart Agent in the same ORB domain, that is to the same `OSAGENT_PORT` number, whereas the VisiNaming Service provides such failover functionality. For more information on the VisiBroker naming service, see [“Using the VisiNaming Service”](#).

## General guidelines

The following are some general guidelines for best practice Smart Agent usage.

- Server registrations should be limited to fewer than 100 object instances or POAs per ORB domain.
- The Smart Agent keeps track of all clients (not just CORBA servers), so every client creates a small load on the Smart Agent. Within any 10 minute period, the client population should generally not exceed 100 clients.

### Note

The GateKeeper counts as one client even though it is acting on behalf of many real clients.

- Applications should use the Smart Agent sparsely by binding to small sets of well known objects at startup and then using those objects for further discovery. The Smart Agent communications are based on UDP. Although the message protocol built on top of UDP is reliable, UDP is often not reliable or allowed in wide area networks. Since the Smart Agent is designed for intranet use, it is not recommended over wide area networks that involve firewall configurations.
- The real default IP of the Smart Agent must be accessible to clients on a subnet that is not directly connected to the Smart Agent host. The Smart Agent cannot be configured for client access behind a Network Address Translation (NAT) firewall.
- The Smart Agent configures itself at startup using the network information available at that time. It is not able to detect new network interfaces that are added later, such as interfaces associated with a dial up connection. Therefore, the Smart Agent is meant for use in static network configurations.

## Load balancing/ fault tolerance guidelines

- The Smart Agent implements load balancing using a simple round-robin algorithm on a per agent basis, not on an ORB domain basis. For load balancing between server replicas, when you have more than one Smart Agent in the ORB domain, make sure all servers are registered with the same Smart Agent.
- The ORB runtime caches access to the Smart Agent, so multiple binds to the same server object from the same ORB process do not result in round-robin behavior because all subsequent attempts to bind to the object use the cache rather than sending a new request to the Smart Agent. This behavior can be changed using ORB properties. For more information see ["Using the Smart Agent"](#).
- When a Smart Agent is terminated, all servers that were registered with that agent attempt to locate another agent with which to register. This process is automatic, but may take up to two minutes for the server to perform this function. During that two minute window, the server is not registered in the ORB domain and therefore is not available to new clients. However, this does not affect ongoing IIOP communications between the server and clients that were previously bound.



## Location service guidelines

The location service is built upon the Smart Agent technology. Therefore, the location service is subject to the same guidelines described above.

- The location service triggers generate UDP traffic between the Smart Agent and the trigger handlers registered by applications. Use of this feature should be limited to less than 10 objects, monitored by less than 10 processes.
- The location service triggers fire when the Smart Agent determines that an object is available or down. There may be a delay of up to four minutes for a “down” trigger to fire. For this reason, you may not want to use this feature for time critical applications.

For more information about the Location Service, see [“Using the Location Service”](#).

## When not to use a Smart Agent

- When the ORB domain spans a large number (greater than 5) of subnets. Maintaining the `agentaddr` files for a large ORB domain spread over a large number of subnets is difficult to manage.
- When the name space requires a large number (greater than 100) of well known objects.
- When the number of applications (clients) that require the Smart Agent consistently exceeds 100 in a 10 minute period.

### Note

In the above situations an alternative directory, such as the Naming Service, may be more appropriate. See [“Using the VisiNaming Service”](#) for more information.

## Locating Smart Agents

VisiBroker locates a Smart Agent for use by a client program or object implementation using a broadcast message. The first Smart Agent to respond is used. After a Smart Agent has been located, a point-to-point UDP connection is used for sending registration and look-up requests to the Smart Agent.

The UDP protocol is used because it consumes fewer network resources than a TCP connection. All registration and locate requests are dynamic, so there are no required configuration files or mappings to maintain.

### Note

Broadcast messages are used only to locate a Smart Agent. All other communication with the Smart Agent makes use of point-to-point communication. For information on how to override the use of broadcast messages, see [“Using point-to-point communications”](#).

## Locating objects through Smart Agent cooperation

When a Smart Agent is started on more than one host in the local network, each Smart Agent will recognize a subset of the objects available and communicate with other Smart Agents to locate objects it cannot find. If one of the Smart Agent processes should terminate unexpectedly, all

implementations registered with that Smart Agent discover this event and they will automatically re register with another available Smart Agent.

## Cooperating with the OAD to connect with objects

Object implementations may be registered with the Object Activation Daemon (OAD) so they can be started on demand. Such objects are registered with the Smart Agent as if they are actually active and located within the OAD. When a client requests one of these objects, it is directed to the OAD. The OAD then forwards the client request to the *actual* server. The Smart Agent does not know that the object implementation is not truly active within the OAD. For more information about the OAD, see [“Using the Object Activation Daemon \(OAD\)”](#).

## Starting a Smart Agent (osagent)

At least one instance of the Smart Agent should be running on a host in your local network. Local network refers to a subnetwork in which broadcast messages can be sent.

### Windows

To start the Smart Agent:

- Double-click the osagent executable `osagent.exe` located in:  
`<install_dir\bin\`  
or
- At the Command Prompt, enter: `osagent [options]`. For example:  

```
prompt> osagent [options]
```

### UNIX

To start the Smart Agent, enter: `osagent &`. For example:

```
prompt> osagent &
```

### Note

Because of signal handling changes, Bourne and Korn shell users need to use the `ignoreSignal hup` parameter when starting `osagent` in order to prevent the hangup (`hup`) signal from terminating the process when the user logs out. For example:

```
nohup $VBROKERDIR/bin/osagent ignoreSignal hup &
```

The `osagent` command accepts the following command line arguments:

Option	Description
<code>-p &lt;UDP_port&gt;</code>	Overrides the setting of <code>OSAGENT_PORT</code> and the registry setting.
<code>-v</code>	Turns verbose mode on, which provides information and diagnostic messages during execution.
<code>-help</code> or <code>-?</code>	Prints the help message.
<code>-l</code>	Turns off logging if <code>OSAGENT_LOGGING_ON</code> is set.
<code>-ls &lt;size&gt;</code>	Specifies trimming log size of 1024KB block. Max value is 300, therefore largest log size is 512MB

Option	Description
+l <options>	Show/enable logging level. Options supported are: <ul style="list-style-type: none"> <li>• Turn logging on and enable level "ief" (== +l oief), equivalent to OSAGENT_LOGGING_ON set. Logs are auto-trim and written to OSAGENT_LOG_DIR or VBROKER_ADM directory if set. Otherwise default is to /tmp on UNIX and %TEMP% on Windows.</li> <li>• i - Informational</li> <li>• e - Error</li> <li>• w - Warning</li> <li>• f - Fatal</li> <li>• d - Debugging</li> <li>• a - All</li> </ul>
-n, -N	Disables system tray icon on Windows.

### Example

The following example of the `osagent` command specifies a particular UDP port:

```
osagent -p 17000
```

## Verbose output

### UNIX

On UNIX, the verbose output is sent to `stdout`.

### Windows

On Windows, the verbose output is written to a log file stored in either of the following locations:

- C:\TEMP\vbroker\log\osagent.log.
- the directory specified by the VBROKER\_ADM environment variable.

### Note

To specify a different directory in which to write the log file, use `OSAGENT_LOG_DIR`. To configure logging options you can right-click the Smart Agent icon and select Log Options.

## Disabling the agent

Communication with the Smart Agent can be disabled by passing the VisiBroker ORB the following property at runtime:

```
prompt> vbj -Dvbroker.agent.enableLocator=false
```

If using string-to-object references, a naming service, or passing in a URL reference, the Smart Agent is not required and can be disabled. If you pass an object name to the `bind()` method, you must use the Smart Agent.

## Ensuring Smart Agent availability

Starting a Smart Agent on more than one host within the local network allows clients to continually bind to objects, even if one Smart Agent terminates unexpectedly. If a Smart Agent becomes unavailable, all object implementations registered with that Smart Agent will be automatically re-

registered with another Smart Agent. If no Smart Agents are running on the local network, object implementations will continue retrying until a new Smart Agent is contacted.

If a Smart Agent terminates, any connections between a client and an object implementation established before the Smart Agent terminated will continue without interruption. However, any new `bind()` requests issued by a client causes a new Smart Agent to be contacted.

No special coding techniques are required to take advantage of these fault-tolerant features. You only need to be sure a Smart Agent is started on one or more host on the local network.

### Checking client existence

A Smart Agent sends an “are you alive” message (often called a *heartbeat* message) to its clients every two minutes to verify the client is still connected. If the client does not respond, the Smart Agent assumes the client has terminated the connection.

You can not change the interval for polling the client.

#### Note

The use of the term “client” does not necessarily describe the function of the object or process. Any program that connects to the Smart Agent for object references is a client.

## Working within VisiBroker ORB domains

It is often useful to have two or more VisiBroker ORB domains running at the same time. One domain might consist of production versions of client programs and object implementations, while another domain might consist of test versions of the same clients and objects that have not yet been released for general use. If several developers are working on the same local network, each may want to establish their own VisiBroker ORB domain so that their tests do not conflict with one another.

**Figure 18** Running separate VisiBroker ORB domains simultaneously

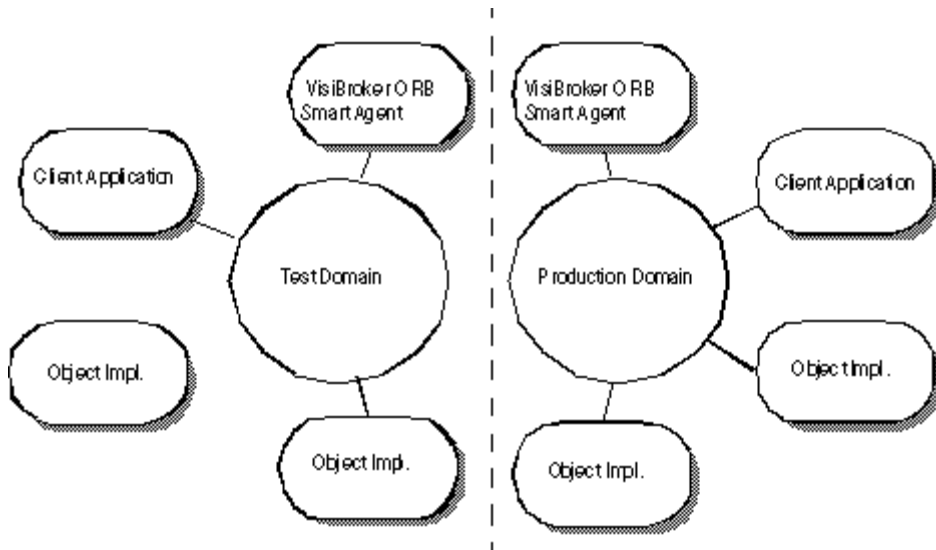

VisiBroker allows you to distinguish between multiple VisiBroker ORB domains on the same network by using unique UDP port numbers for the Smart Agents of each domain. By default, the `OSAGENT_PORT` variable is set

to 14000. If you wish to use a different port number, check with your system administrator to determine what port numbers are available.

To override the default setting, the `OSAGENT_PORT` variable must be set accordingly before running a Smart Agent, an OAD, object implementations, or client programs assigned to that VisiBroker ORB domain. For example,

```
prompt> setenv OSAGENT_PORT 5678
prompt> osagent &
prompt> oad &
```

The Smart Agent uses an additional internal port number for both TCP and UDP protocols, the port number is the same for both. This port number is set by using the `OSAGENT_CLIENT_HANDLER_PORT` environment variable.

## Connecting Smart Agents on different local networks

If you start multiple Smart Agents on your local network, they will discover each other by using UDP broadcast messages. Your network administrator configures a local network by specifying the scope of broadcast messages using the IP subnet mask. The following figure shows two local networks connected by a network link.

**Figure 19** Two Smart Agents on separate local networks

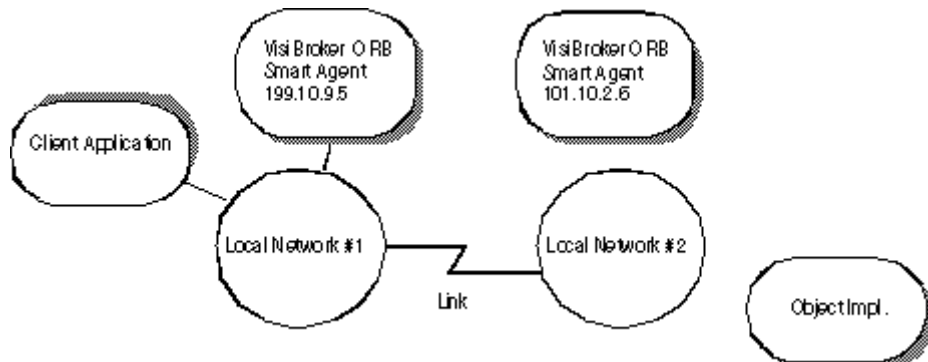

To allow the Smart Agent on one network to contact a Smart Agent on another local network, use the `OSAGENT_ADDR_FILE` environment variable, as shown in the following example:

```
setenv OSAGENT_ADDR_FILE=<path to agent addr file>
```

Alternatively, use the `vbroker.agent.addrFile` property, as shown in the following example:

```
vbj -Dvbroker.agent.addrFile=<path to agent addr file>
....
```

The following example shows what the `agentaddr` file would contain to allow a Smart Agent on Local Network #1 to connect to a Smart Agent on another local network.

```
101.10.2.6
```

With the appropriate `agentaddr` file, a client program on Network #1 locates and uses object implementations on Network #2. For more information on environment variables, see the *VisiBroker Installation Guide*.

**Note**

If a remote network has multiple Smart Agents running, you should list all the IP addresses of the Smart Agents on the remote network.

**How Smart Agents detect each other**

Suppose two agents, Agent 1 and Agent 2, are listening on the same UDP port from two different machines on the same subnet. Agent 1 starts before Agent 2. The following events occur:

- When Agent 2 starts, it UDP broadcasts its existence and sends a request message to locate any other Smart Agents.
  - Agent 1 notes that Agent 2 is available on the network and responds to the request message.
  - Agent 2 notes that another agent, Agent 1, is available on the network.
- If Agent 2 is terminated gracefully (such as killing with *Ctrl+C*), Agent 1 is notified that Agent 2 is no longer available.

**Working with multihomed hosts**

When you start the Smart Agent on a host that has more than one IP address (known as a multihomed host), it can provide a powerful mechanism for bridging objects located on separate local networks. All local networks to which the host is connected will be able to communicate with a single Smart Agent, therefore bridging the local networks.

**Figure 20** Smart Agent on a multihomed host

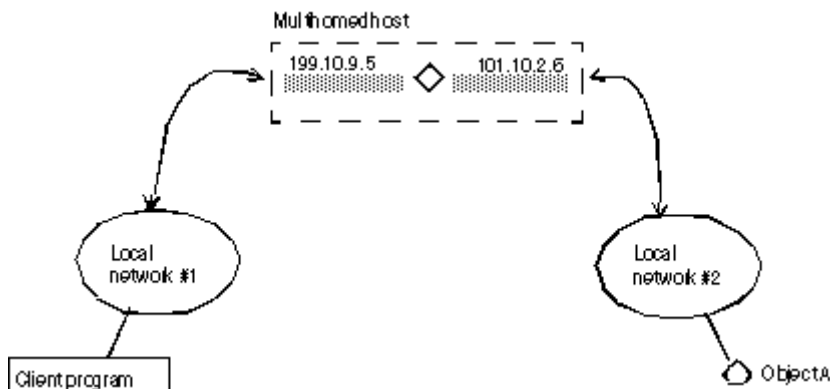
**UNIX**

On a multihomed UNIX host, the Smart Agent dynamically configures itself to listen and broadcast on all of the host's interfaces which support point-to-point connections or broadcast connections. You can explicitly specify interface settings using the `localaddr` file as described in [“Specifying interface usage for Smart Agents”](#).

**Windows**

On a multihomed Windows host, the Smart Agent is not able to dynamically determine the correct subnet mask and broadcast address values. To overcome this limitation, you must explicitly specify the interface settings you want the Smart Agent to use with the `localaddr` file.

When you start the Smart Agent with the `-v` (verbose) option, each interface that the Smart Agent uses will be listed at the beginning of the messages produced. The example below shows the sample output from a Smart Agent started with the verbose option on a multihomed host.

```
Bound to the following interfaces:
Address: 199.10.9.5 Subnet: 255.255.255.0
Broadcast:199.10.9.255
Address: 101.10.2.6 Subnet: 255.255.255.0
Broadcast:101.10.2.255
...
```

The above output shows the address, subnet mask, and broadcast address for each interface in the machine.

## UNIX

The above output should match the results from the UNIX command `ifconfig -a`.

If you want to override these settings, configure the interface information in the `localaddr` file. See [“Specifying interface usage for Smart Agents”](#) for details.

## Specifying interface usage for Smart Agents

### Note

It is not necessary to specify interface information on a single-homed host.

You can specify interface information for each interface you wish the Smart Agent to use on your multihomed host in the `localaddr` file. The `localaddr` file should have a separate line for each interface that contains the host's IP address, subnet mask, and broadcast address. By default, VisiBroker searches for the `localaddr` file in the `VBROKER_ADM` directory. You can override this location by setting the `OSAGENT_LOCAL_FILE` environment variable to point to this file. Lines in this file that begin with a “#” character, and are treated as comments and ignored. The code sample below shows the contents of the `localaddr` file for the multihomed host listed above.

```
#entries of format <address> <subnet_mask> <broadcast
address>
199.10.9.5 255.255.255.0 199.10.9.255
101.10.2.6 255.255.255.0 101.10.2.255
```

## UNIX

Though the Smart Agent can automatically configure itself on a multihomed host on UNIX, you can use the `localaddr` file to explicitly specify the interfaces that your host contains. You can display all available interface values for the UNIX host by using the following command:

```
prompt> ifconfig -a
```

Output from this command appears similar to the following:

```
lo0: flags=849<UP,LOOPBACK,RUNNING,MULTICAST> mtu 8232
    inet 127.0.0.1 netmask ffffffff
le0: flags=863<UP,BROADCAST,NOTRAILERS,RUNNING,MULTICAST> mtu 1500
    inet 199.10.9.5 netmask ffffffff broadcast 199.10.9.255
le1: flags=863<UP,BROADCAST,NOTRAILERS,RUNNING,MULTICAST> mtu 1500
    inet 101.10.2.6 netmask ffffffff broadcast 101.10.2.255
```

## Windows

The use of the `localaddr` file with multihomed hosts is required for hosts running Windows because the Smart Agent is not able to automatically configure itself. You can obtain the appropriate values for this file by accessing the TCP/IP protocol properties from the Network Control Panel. If your host is running Windows, the `ipconfig` command will provide the needed values. This command is as follows:

```
prompt> ipconfig
```

Output from this command appears similar to the following:

```
Ethernet adapter El90x1:
    IP Address. . . . . : 172.20.30.56
    Subnet Mask . . . . . : 255.255.255.0
    Default Gateway . . . . . : 172.20.0.2
Ethernet adapter Elnk32:
    IP Address. . . . . : 101.10.2.6
    Subnet Mask . . . . . : 255.255.255.0
    Default Gateway. . . . . : 101.10.2.1
```

## Using point-to-point communications

VisiBroker provides three different mechanisms for circumventing the use of UDP broadcast messages for locating Smart Agent processes. When a Smart Agent is located with any of these alternate approaches, that Smart Agent will be used for all subsequent interactions. If a Smart Agent cannot be located using any of these alternate approaches, VisiBroker will revert to using the broadcast message scheme to locate a Smart Agent.

### Specifying a host as a runtime parameter

The code sample below shows how to specify the IP address where a Smart Agent is running as a runtime parameter for your client program or object implementation. Since specifying an IP address will cause a point-to-point connection to be established, you can even specify an IP address of a host located outside your local network. This mechanism takes precedence over any other host specification.

```
prompt> vbj -Dvbroker.agent.addr=<ip_address> Server
```

You can also specify the IP address through the properties file. Look for the `vbroker.agent.addr` entry.

```
vbroker.agent.addr=<ip_address>
```

By default, `vbroker.agent.addr` in the properties file is set to `NULL`.

You can also list the host names where the agent might reside and then point to that file with the `vbroker.agent.addrFile` option in the properties file.

### Specifying an IP address with an environment variable

You can specify the IP address of a Smart Agent by setting the `OSAGENT_ADDR` environment variable prior to starting your client program or object implementation. This environment variable takes precedence if a host is not specified as a runtime parameter.



## UNIX

```
prompt> setenv OSAGENT_ADDR 199.10.9.5
prompt> client
```

## Windows

To set the `OSAGENT_ADDR` environment variable on a Windows system, you can use the System control panel and edit the environment variables:

- 1 Under System Variables, select any current variable.
- 2 Type `OSAGENT_ADDR` in the Variable edit box.
- 3 Type the IP address in the Value edit box. For example, `199.10.9.5`.

## Specifying hosts with the `agentaddr` file

Your client program or object implementation can use the `agentaddr` file to circumvent the use of a UDP broadcast message to locate a Smart Agent. Simply create a file containing the IP addresses or fully qualified hostnames of each host where a Smart Agent is running and then set the `OSAGENT_ADDR_FILE` environment variable to point to the path of the file. When a client program or object implementation has this environment variable set, VisiBroker will try each address in the file until a Smart Agent is located. This mechanism has the lowest precedence of all the mechanisms for specifying a host. If this file is not specified, the `VBROKER_ADM/agentaddr` file is used.

# Ensuring object availability

You can provide fault tolerance for objects by starting instances of those objects on multiple hosts. If an implementation becomes unavailable, the VisiBroker ORB will detect the loss of the connection between the client program and the object implementation and will automatically contact the Smart Agent to establish a connection with another instance of the object implementation, depending on the effective rebind policy established by the client. For more information on establishing client policies, go to the Client basics, [“Using Quality of Service \(QoS\)”](#).

### Note

The Smart Agent implements load balancing using a simple round-robin algorithm on a per agent basis, not on an ORB domain basis. For load balancing between server replicas, when you have more than one Smart Agent in the ORB domain, make sure all servers are registered with the same Smart Agent.

### Important

The rebind option must be enabled if VisiBroker is to attempt reconnecting the client with an instance object implementation. This is the default behavior.

## Invoking methods on stateless objects

Your client program can invoke a method on an object implementation which does not maintain state without being concerned if a new instance of the object is being used.

## Achieving fault-tolerance for objects that maintain state

Fault tolerance can also be achieved with object implementations that maintain state, but it will not be transparent to the client program. In these cases, your client program must either use the Quality of Service (QoS) policy `VB_NOTIFY_REBIND` or register an interceptor for the VisiBroker ORB object. For information on using QoS, see [“Using Quality of Service \(QoS\)”](#).

When the connection to an object implementation fails and VisiBroker reconnects the client to a replica object implementation, the `bind` method of the bind interceptor will be invoked by VisiBroker. The client must provide an implementation of this bind method to bring the state of the replica up to date. Client interceptors are described in [“Client Interceptors”](#).

## Replicating objects registered with the OAD

The OAD ensures greater object availability because if the object goes down, the OAD will restart it. If you want fault tolerance for hosts that may become unavailable, the OAD must be started on multiple hosts and the objects must be registered with each OAD instance.

### Note

The type of object replication provided by VisiBroker does not provide a multicast or mirroring facility. At any given time there is always a one-to-one correspondence between a client program and a particular object implementation.

## Migrating objects between hosts

Object migration is the process of terminating an object implementation on one host, and then starting it on another host. Object migration can be used to provide load balancing by moving objects from overloaded hosts to hosts that have more resources or processing power (there is no load balancing between servers registered with different Smart Agents.) Object migration can also be used to keep objects available when a host is shutdown for hardware or software maintenance.

### Note

The migration of objects that do not maintain state is transparent to the client program. If a client is connected to an object implementation that has migrated, the Smart Agent will detect the loss of the connection and transparently reconnect the client to the new object on the new host.

## Migrating objects that maintain state

The migration of objects that maintain state is also possible, but it will not be transparent to a client program that has connected before the migration process begins. In these cases, the client program must register an interceptor for the object.

When the connection to the original object is lost and VisiBroker reconnects the client to the object, the interceptor's `rebind_succeeded()` member function will be invoked by VisiBroker. The client can implement this function to bring the state of the object up to date.

Refer to [“Using Portable Interceptors”](#) for more information about how to use the interceptors.

## Migrating instantiated objects

If the objects that you wish to migrate were created by a server process instantiating the implementation’s class, you need only start it on a new host and terminate the server process. When the original instance is terminated, it will be unregistered with the Smart Agent. When the new instance is started on the new host, it will register with the Smart Agent. From that point on, client invocations are routed to the object implementation on the new host.

## Migrating objects registered with the OAD

If VisiBroker objects that you wish to migrate are registered with the OAD, you must first unregister them with the OAD on the old host. Then, reregister them with the OAD on the new host.

Use the following procedure to migrate objects already registered with the OAD:

- 1 Unregister the object implementation from the OAD on the old host.
- 2 Register the object implementation with the OAD on the new host.
- 3 Terminate the object implementation on the old host.

See [“Using the Object Activation Daemon \(OAD\)”](#) for detailed information on registering and unregistering object implementations.

## Reporting all objects and services

The Smart Finder (`osfind`) command reports on all VisiBroker related objects and services which are currently available on a given network.

You can use `osfind` to determine the number of Smart Agent processes running on the network and the exact host on which they are executing. The `osfind` command also reports on all VisiBroker objects that are active on the network if these objects are registered with the Smart Agent. You can use `osfind` to monitor the status of the network and locate stray objects during the debugging phase.

The `osfind` command has the following syntax:

```
osfind [options]
```

The following options are valid with `osfind`. If no options are specified, `osfind` lists all of the agents, OADs, and implementations in your domain.

Option	Description
-a	Lists all Smart Agents in your domain.
-b	Uses the VisiBroker 2.0 backward compatible <code>osfind</code> mechanism.
-d	Prints hostnames as quad addresses.
-f <agent_address_file_name>	Queries Smart Agents running on the hosts specified in the file. This file contains one IP address or fully qualified host name per line. Note that this file is not used when reporting all Smart Agents; it is only used when reporting objects implementations and services.
-g	Verifies object existence. This can cause considerable delay on loaded systems. Only objects registered <code>BY_INSTANCE</code> are verified for existence. Objects that are either registered with the OAD, or those registered <code>BY_POA</code> policy are not verified for existence.

Option	Description
-h, -help, -usage, -?	Prints help information for this option.
-o	Lists all OADs in your domain.
-p	Lists all POA instances activated on the same host. Without this option only unique POA names are listed.

---

### Windows

`osfind` is a console application. If you start `osfind` from the Start menu, it runs until completion and exits before you can view the results.

## Binding to Objects

Before your client application invokes a method on an interface it must obtain an object reference using the `bind()` method.

When your client application invokes the `bind()` method, `VisiBroker` performs several functions on behalf of your application. These are shown below.

- `VisiBroker` contacts the `osagent` to locate an object server that is offering the requested interface. If an object name and a host name (or IP address) are specified, they will be used to further qualify the directory service search.
- When an object implementation is located, `VisiBroker` attempts to establish a connection between the object implementation that was located and your client application.
- If the connection is successfully established, `VisiBroker` will create a proxy object if necessary, and return a reference to that object.

### Note

`VisiBroker` is not a separate process. It is a collection of classes and other resources that allow communication between clients and servers.

# Using the Location Service

The VisiBroker Location Service provides enhanced object discovery that enables you to find object instances based on particular attributes. Working with VisiBroker Smart Agents, the Location Service notifies you of what objects are presently accessible on the network, and where they reside. The Location Service is a VisiBroker extension to the CORBA specification and is only useful for finding objects implemented with VisiBroker. For more information on the Smart Agent (`osagent`), see [“Using the Smart Agent”](#).

## What is the Location Service?

The Location Service is an extension to the CORBA specification that provides general-purpose facilities for locating object instances. The Location Service communicates directly with one Smart Agent which maintains a *catalog*, which contains the list of the instances it knows about. When queried by the Location Service, a Smart Agent forwards the query to the other Smart Agents, and aggregates their replies in the result it returns to the Location Service.

The Location Service knows about all object instances that are registered on a POA with the `BY_INSTANCE` Policy and objects that are registered as persistent on a BOA. The server containing these objects may be started manually or automatically by the OAD. For more information, see [“Using POAs”](#), [“Using the BOA with VisiBroker,”](#) and [“Using the Object Activation Daemon \(OAD\)”](#). (A server specifies an instance's scope when it creates the instance. Only globally-scoped instances are registered with Smart Agents.)

The following diagram illustrates this concept.

**Figure 21** Using the Smart Agent to find instances of objects

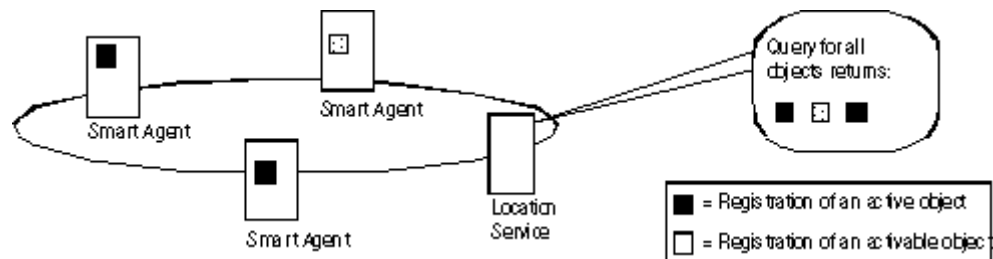

The Location Service can make use of the information the Smart Agent keeps about each object instance. For each object instance, the Location Service maintains information encapsulated in the structure `ObjLocation::Desc` shown below.

```
struct Desc {
    Object ref;
    ::IIOP::ProfileBodyValue iiop_locator;
    string repository_id;
    string instance_name;
    boolean activable;
    string agent_hostname;
};
typedef sequence<Desc> DescSeq;
```

The IDL for the Desc structure contains the following information:

- The object reference, *ref*, is a handle for invoking the object.
- The *iiop\_locator* interface provides access to the host name and the port of the instance's server. This information is only meaningful if the object is connected with IIOP, which is the only supported protocol. Host names are returned as strings in the instance description.
- The *repository\_id*, which is the interface designation for the object instance that can be looked up in the Interface and Implementation Repositories. If an instance satisfies multiple interfaces, the catalog contains an entry for each interface, as if there were an instance for each interface.
- The *instance\_name*, which is the name given to the object by its server.
- The *activable* flag, which differentiates between instances that can be activated by an OAD and instances that are started manually.
- The *agent\_hostname*, the name of the Smart Agent with which the instance is registered.

The Location Service is useful for purposes such as load balancing and monitoring. Suppose that replicas of an object are located on several hosts. You could deploy a bind interceptor that maintains a cache of the host names that offer a replica and each host's recent load average. The interceptor updates its cache by asking the Location Service for the hosts currently offering instances of the object, and then queries the hosts to obtain their load averages. The interceptor then returns an object reference for the replica on the host with the lightest load. For more information about writing interceptors, see ["Using Portable Interceptors"](#) and ["Using VisiBroker Interceptors"](#).

## Location Service components

The Location Service is accessible through the Agent interface. Methods for the Agent interface can be divided into two groups: those that query a Smart Agent for data describing instances and those that register and unregister *triggers*. Triggers provide a mechanism by which clients of the Location Service can be notified of changes to the availability of instances.

### What is the Location Service agent?

The Location Service agent is a collection of methods that enable you to discover objects on a network of Smart Agents. You can query based on the interface's repository ID, or based on a combination of the interface's repository ID and the instance name. Results of a query can be returned as either *object references* or more complete *instance descriptions*. An object reference is simply a handle to a specific instance of the object located by a Smart Agent. Instance descriptions contain the object reference, as well as the instance's interface name, instance name, host name and port number, and information about its state (for example, whether it is running or can be activated).

#### Note

The `locserv` executable no longer exists since the service is now part of the core VisiBroker ORB.

The figure below illustrates the use of interface repository IDs and instance names given the following example IDL:

```
module Automobile {
    interface Car {...};
    interface Sedan:Car {...};
}
```

**Figure 22** Use of interface repository IDs and instance names

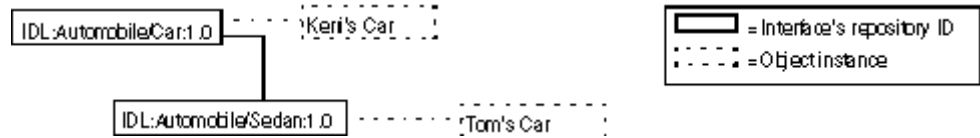

Given the previous example, the following diagram visually depicts Smart Agents on a network with references to instances of Car. In this example, there are three instances: one instance of Keri's Car and two replicas of Tom's Car.

**Figure 23** Smart Agents on a network with instances of an interface

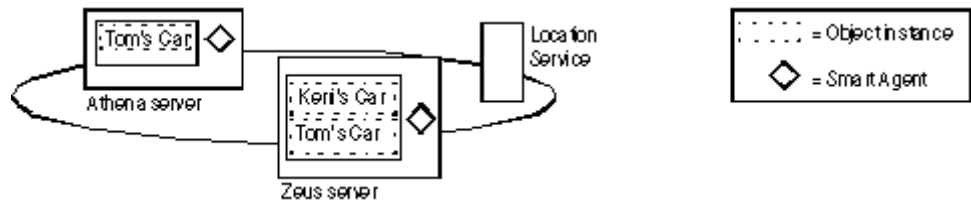

The following sections explain how the methods provided by the Agent class can be used to query VisiBroker Smart Agents for information. Each of the query methods can raise the Fail exception, which provides a reason for the failure.

## Obtaining addresses of all hosts running Smart Agents

Using the `String[]` in the `all_agent_locations()` method, you can find out which servers are hosting VisiBroker Smart Agents. In the example shown in the figure below, this method would return the addresses (such as, IP address string) of two servers: Athena and Zeus.

## Finding all accessible interfaces

You can query the VisiBroker Smart Agents on a network to find out about all accessible interfaces. To do so, you can use the `String[]` in the `all_repository_ids()` method. In the example shown in the following figure, this method would return the repository IDs of two interfaces: Car and Sedan.

### Note

Earlier versions of the VisiBroker ORB used IDL interface names to identify interfaces, but the Location Service uses the repository id instead. To illustrate the difference, if an interface name is:

```
::module1::module2::interface
```

the equivalent repository id is:

```
IDL:module1/module2/interface:1.0
```

For the example shown in the figure above, the repository ID for Car would be:

IDL:Automobile/Car:1.0

and the repository ID for Sedan would be:

IDL:Automobile/Sedan:1.0

## Obtaining references to instances of an interface

You can query VisiBroker Smart Agents on a network to find all available instances of a particular interface. When performing the query, you can use either of these methods:

Method	Description
<pre>org.omg.CORBA.Object [] all_instances(String repository_id) Desc [] all_instance_descs(String repository_id)</pre>	<p>Use this method to return object references to instances of the interface.</p> <p>Use this method to return an instance description for instances of the interface.</p>

In the example shown in the figure above, a call to either method with the request IDL:Automobile/Car:1.0 would return three instances of the Car interface: Tom's Car on Athena, Tom's Car on Zeus, and Keri's Car. The Tom's Car instance is returned twice because there are occurrences of it with two different Smart Agents.

## Obtaining references to like-named instances of an interface

Using one of the following methods, you can query VisiBroker Smart Agents on a network to return all occurrences of a particular instance name.

Method	Description
<pre>org.omg.CORBA.Object [] all_replica String repository_id, String instance_name Desc [] all_replica_descs(String repository_id, String instance_name)</pre>	<p>Use this method to return object references to like-named instances of the interface.</p> <p>Use this method to return an instance description for like-named instances of the interface.</p>

In the example shown in the previous figure, a call to either method specifying the repository ID IDL:Automobile/Sedan:1.0 and instance name Tom's Car would return two instances because there are occurrences of it with two different Smart Agents.

## What is a trigger?

A trigger is essentially a callback mechanism that lets you determine changes to the availability of a specified instance. It is an asynchronous alternative to polling an Agent, and is typically used to recover after the connection to an object has been lost. Whereas queries can be employed in many ways, triggers are special-purpose.



## Looking at trigger methods

The trigger methods in the `Agent` class are described in the following tables:

Methods	Description
<pre>void reg_trigger( com.inprise.vbroker.ObjLocation. TriggerDesc desc, com.inprise. vbroker.ObjLocation.TriggerHandler handler)</pre>	Use this method to register a trigger handler.
<pre>void unreg_trigger( com.inprise.vbroker.ObjLocation. TriggerDesc desc, com.inprise. vbroker.ObjLocation.TriggerHandler handler)</pre>	Use this method to unregister a trigger handler.

Both of the `Agent` trigger methods can raise the `Fail` exception, which provides a reason for the failure.

The `TriggerHandler` interface consists of the methods described in the following tables:

Method	Description
<pre>void impl_is_ready(com.inprise. vbroker.ObjLocation.TriggerDesc desc)</pre>	This method is called by the Location Service when an instance matching the <code>desc</code> becomes accessible.
<pre>void impl_is_down (com.inprise.vbroker. ObjLocation. TriggerDesc desc)</pre>	This method is called by the Location Service when an instance becomes unavailable.

## Creating triggers

A `TriggerHandler` is a callback object. You implement a `TriggerHandler` by deriving from the `TriggerHandlerPOA` class (or the `TriggerHandlerImpl` class with BOA), and implementing its `impl_is_ready()` and `impl_is_down()` methods. To register a trigger with the Location Service, you use the `reg_trigger()` method in the `Agent` interface. This method requires that you provide a description of the instance you want to monitor, and the `TriggerHandler` object you want invoked when the availability of the instance changes. The instance description (`TriggerDesc`) can contain combinations of the following instance information: repository ID, instance name, and host name. The more instance information you provide, the more particular your specification of the instance.

```
struct TriggerDesc {
    string repository_id;
    string instance_name;
    string host_name;
};
```

### Note

If a field in the `TriggerDesc` is set to the empty string (`""`), it is ignored. The default for each field value is the empty string.

For example, a `TriggerDesc` containing only a repository ID matches any instance of the interface. Looking back to our example in the figure above, a trigger for any instance of `IDL:Automobile/Car:1.0` would occur when one of the following instances becomes available or unavailable: Tom's Car on Athena, Tom's Car on Zeus, or Keri's Car. Adding an instance name of "Tom's Car" to the `TriggerDesc` tightens the specification so that the

trigger only occurs when the availability of one of the two "Tom's Car" instances changes. Finally, adding a host name of Athena refines the trigger further so that it only occurs when the instance Tom's Car on the Athena server becomes available or unavailable.

### Looking at only the first instance found by a trigger

Triggers are "sticky." A `TriggerHandler` is invoked every time an object satisfying the trigger description becomes accessible. You may only be interested in learning when the first instance becomes accessible. If this is the case, invoke the `Agent`'s `unreg_trigger()` method to unregister the trigger after the first occurrence is found.

## Querying an agent

This section contains two examples of using the Location Service to find instances of an interface. The first example uses the `Account` interface shown in the following IDL excerpt:

```
// Bank.idl
module Bank {
    interface Account {
        float balance();
    };
    interface AccountManager {
        Account open (in string name);
    };
};
```

### Finding all instances of an interface

The following code sample uses the `all_instances()` method to locate all instances of the `Account` interface. Notice that the Smart Agents are queried by passing "LocationService" to the `ORB.resolve_initial_references()` method, then narrowing the object returned by that method to an `ObjLocation.Agent`. Notice, as well, the format of the `Account` repository id: `IDL:Bank/Account:1.0`. To find all instances satisfying the `AccountManager` interface:

```
// AccountFinder.java
public class AccountFinder {
    public static void main(String[] args) {
        try {
            // Initialize the ORB.
            org.omg.CORBA.ORB orb =
            org.omg.CORBA.ORB.init(args,null);
            com.inprise.vbroker.ObjLocation.Agent the_agent =
            null;
            try {
                the_agent =
                com.inprise.vbroker.ObjLocation.AgentHelper.narrow(
                orb.resolve_initial_references("LocationService"));
            }
            catch (org.omg.CORBA.ORBPackage.InvalidName e) {
                System.out.println("Not able to resolve references "
                +
                "for LocationService");
                System.exit(1);
            }
        }
    }
}
```

```

    }
    catch (Exception e) {
        System.out.println("Unable to locate
LocationService!");
        System.out.println("Caught exception: " + e);
        System.exit(1);
    }
    org.omg.CORBA.Object[] accountRefs =
        the_agent.all_instances("IDL:Bank/
AccountManager:1.0");
    System.out.println("Agent returned " +
accountRefs.length + " object references");
    for (int i=0; i < accountRefs.length; i++) {
        System.out.println("Stringified IOR for account #" +
(i+1) + ":");
    }

    System.out.println(orb.object_to_string(accountRefs[i]));
    System.out.println();
    }
    catch (Exception e) {
        System.out.println("Caught exception: " + e);
        System.exit(1);
    }
    }
}
}

```

## Finding interfaces and instances known to Smart Agents

The following code sample shows how to find everything known to Smart Agents. It does this by invoking the `all_repository_ids()` method to obtain all known interfaces. Then it invokes the `all_instances_descs()` method for each interface to obtain the instance descriptions.

Finding everything known to a Smart Agent:

```

// Find.java
public class Find {
    public static void main(String[] args) {
        try {
            // Initialize the ORB.
            org.omg.CORBA.ORB orb =
org.omg.CORBA.ORB.init(args,null);
            com.inprise.vbroker.ObjLocation.Agent agent = null;
            try {
                agent =
com.inprise.vbroker.ObjLocation.AgentHelper.narrow(
orb.resolve_initial_references("LocationService"));
            } catch (org.omg.CORBA.ORBPackage.InvalidName e) {
                System.out.println("Not able to resolve
references " + "for
LocationService");
                System.exit(1);
            } catch (Exception e) {
                System.out.println("Not able to resolve
references " + "for
LocationService");
                System.out.println("Caught exception: " + e);
                System.exit(1);
            }
        }
    }
}

```

```

    }
    boolean done=false;
    java.io.BufferedReader in =
        new java.io.BufferedReader(new
java.io.InputStreamReader(System.in));
    while (! done) {
        System.out.print("-> ");
        System.out.flush();
        String line = in.readLine();
        if(line.startsWith("agents")) {
            java.lang.String[] agentList =
agent.all_agent_locations();
            System.out.println("Located " +
agentList.length + " agents");
            for (int i=0; i < agentList.length; i++) {
                System.out.println("\t" + "Agent #" +
(i+1) + ": " +
                    agentList[i]);
            }
        } else if(line.startsWith("rep")) {
            java.lang.String[] repIds =
agent.all_repository_ids();
            System.out.println("Located " + repIds.length
+ " repository Ids");
            for (int i=0; i < repIds.length; i++) {
                System.out.println("\t" + "Repository Id #"
+ (i+1) + ": " +
                    repIds[i]);
            }
        } else if(line.startsWith("objects ")) {
            String names = line.substring("objects
".length(), line.length());
            PrintObjects(names,agent,orb);
        } else if(line.startsWith("quit")) {
            done = true;
        } else {
            System.out.println("Commands: agents\n" +
                "        repository_ids\n" +
                "        objects      <rep Id>\n" +
                "        objects      <rep Id> <obj
name>\n" +
                "        quit\n");
        }
    } catch (com.inprise.vbroker.ObjLocation.Fail err) {
        System.out.println("Location call failed with reason
" + err.reason);
    } catch (java.lang.Exception err) {
        System.out.println("Caught error " + err);
        err.printStackTrace();
    }
}
}
public static void PrintObjects(String names,
    com.inprise.vbroker.ObjLocation.Agent agent,
    org.omg.CORBA.ORB orb)
    throws com.inprise.vbroker.ObjLocation.Fail {
    int space_pos = names.indexOf(' ');
    String repository_id;
    String object_name;

```

```

        if (space_pos == -1) {
            repository_id = names;
            object_name = null;
        } else {
            repository_id = names.substring(0,names.indexOf('
'));
            object_name = names.substring(names.indexOf(' ') + 1);
        }
        org.omg.CORBA.Object[] objects;
        com.inprise.vbroker.ObjLocation.Desc[] descriptors;
        if (object_name == null) {
            objects = agent.all_instances(repository_id);
            descriptors =
agent.all_instances_descs(repository_id);
        } else {
            objects =
agent.all_replica(repository_id,object_name);
            descriptors =
agent.all_replica_descs(repository_id,object_name);
        }
        System.out.println("Returned " + objects.length + "
objects");
        for (int i=0; i<objects.length; i++) {
            System.out.println("\n\nObject #" + (i+1) + ":");
            System.out.println("=====");
            System.out.println("\tRep ID: " +

((com.inprise.vbroker.CORBA.Object)objects[i])._repository
_id());
            System.out.println("\tInstance: " +

((com.inprise.vbroker.CORBA.Object)objects[i])._object_nam
e());
            System.out.println("\tIOR: " +
orb.object_to_string(objects[i]));
            System.out.println();
            System.out.println("Descriptor #" + (i+1));

System.out.println("====="
);
            System.out.println("Host:           " +
descriptors[i].iiop_locator.host);
            System.out.println("Port:           " +
descriptors[i].iiop_locator.port);
            System.out.println("Agent Host:      " +
descriptors[i].agent_hostname);
            System.out.println("Repository Id:  " +
descriptors[i].repository_id);
            System.out.println("Instance:       " +
descriptors[i].instance_name);
            System.out.println("Activable:      " +
descriptors[i].activable);
        }
    }
}

```

## Writing and registering a trigger handler

The following code sample implements and registers a `TriggerHandler`. The `TriggerHandlerImpl`'s `impl_is_ready()` and `impl_is_down()` methods display the description of the instance that caused the trigger to be invoked, and optionally unregister itself.

If it is unregistered, the method calls `System.exit()` to terminate the program.

Notice that the `TriggerHandlerImpl` class keeps a copy of the `desc` and `Agent` parameters with which it was created. The `unreg_trigger()` method requires the `desc` parameter. The `Agent` parameter is duplicated in case the reference from the main program is released.

Implementing a trigger handler:

```
// AccountTrigger.java
import java.io.*;
import org.omg.PortableServer.*;
class TriggerHandlerImpl extends
    com.inprise.vbroker.ObjLocation.TriggerHandlerPOA {
    public
    TriggerHandlerImpl(com.inprise.vbroker.ObjLocation.Agent
    agent,
        com.inprise.vbroker.ObjLocation.TriggerDesc
    initial_desc) {
        agent = agent;
        initial_desc = initial_desc;
    }
    public void
    impl_is_ready(com.inprise.vbroker.ObjLocation.Desc desc) {
        notification(desc, true);
    }
    public void
    impl_is_down(com.inprise.vbroker.ObjLocation.Desc desc) {
        notification(desc, false);
    }
}

private void notification(com.inprise.vbroker.ObjLocation.Desc desc,
    boolean isReady) {
    if (isReady) {
        System.out.println("Implementation is ready:");
    } else {
        System.out.println("Implementation is down:");
    }
}

System.out.println("\tRepository Id = " + desc.repository_id + "\n" +
    "\tInstance Name = " + desc.instance_name + "\n" +
    "\tHost Name      = " + desc.iiop_locator.host + "\n" +
    "\tBOA Port       = " + desc.iiop_locator.port + "\n" +
    "\tActivable      = " + desc.activable + "\n" + "\n");
System.out.println("Unregister this handler and exit (yes/no)?");
try {
    BufferedReader in = new BufferedReader(
        new InputStreamReader(System.in));
    String line = in.readLine();
    if(line.startsWith("y") || line.startsWith("Y")) {
        try {
            agent.unreg_trigger(_initial_desc, _this());
        } catch (com.inprise.vbroker.ObjLocation.Fail e) {
            System.out.println("Failed to unregister trigger with
            reason=[" + e.reason + "]);
        }
    }
}
```

```

        }
        System.out.println("exiting...");
        System.exit(0);
    }
} catch (java.io.IOException e) {
    System.out.println("Unexpected exception caught: " + e);
    System.exit(1);
}
}
private com.inprise.vbroker.ObjLocation.Agent _agent;
private com.inprise.vbroker.ObjLocation.TriggerDesc _initial_desc;
}
public class AccountTrigger {
    public static void main(String args[]) {
        try {
            // Initialize the ORB.
            org.omg.CORBA.ORB orb = org.omg.CORBA.ORB.init(args,null);
            POA rootPoa =
                POAHelper.narrow(orb.resolve_initial_references("RootPOA"));
            rootPoa.the_POAManager().activate();
            com.inprise.vbroker.ObjLocation.Agent the_agent =
                com.inprise.vbroker.ObjLocation.AgentHelper.narrow(
orb.resolve_initial_references("LocationService"));
            // Create a trigger description and an appropriate TriggerHandler.
            // The TriggerHandler will be invoked when the osagent becomes
            // aware of any new implementations of the interface
            "Bank::AccountManager"
            com.inprise.vbroker.ObjLocation.TriggerDesc desc =
                new com.inprise.vbroker.ObjLocation.TriggerDesc
                    "IDL:Bank/AccountManager:1.0", "", "");
            TriggerHandlerImpl trig = new TriggerHandlerImpl(the_agent, desc);
            rootPoa.activate_object(trig);
            the_agent.reg_trigger(desc, trig._this());
            orb.run();
        } catch (Exception e) {
            e.printStackTrace();
            System.exit(1);
        }
    }
}
}

```





# Using the VisiNaming Service

This section describes the usage of the VisiBroker VisiNaming Service which is a complete implementation of the CORBA Naming Service Specification Version 1.2 (formal/02-09-02).

## Overview

The VisiNaming Service allows you to associate one or more *logical* names with an object reference and store those names in a *namespace*. With the VisiNaming Service, your client applications can obtain an object reference by using the logical name assigned to that object.

The figure below contains a simplified view of the VisiNaming Service that shows how:

- 1 an object implementation can *bind* a name to one of its objects within a namespace.
- 2 client applications can then use the same namespace to *resolve* a name which returns an object reference to a naming context or an object.

**Figure 24** Binding, resolving, and using an object name from a naming context within a namespace

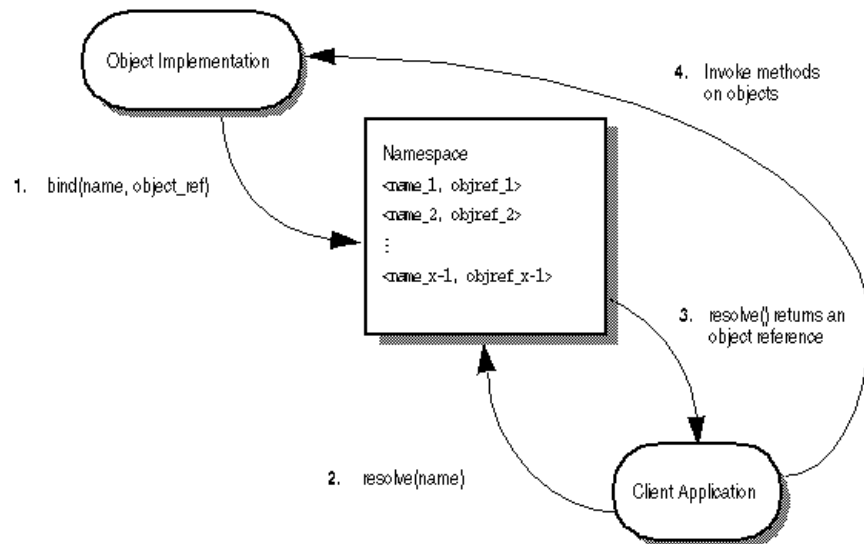

There are some important differences to consider between locating an object implementation with the VisiNaming Service and doing so with the Smart Agent.

- Smart Agent uses a flat namespace, while the VisiNaming Service uses a hierarchical one.
- If you use the Smart Agent, an object's interface name is defined at the time you compile your client and server applications. This means that if you change an interface name, you must recompile your applications. In contrast, the VisiNaming service allows object implementations to bind logical names to its objects at runtime.

- If you use the Smart Agent, an object may implement only one interface name. The VisiNaming service allows you to bind more than one logical name to a single object.

For more information about the Smart Agent (osagent), see [“Using the Smart Agent”](#).

## Understanding the namespace

The figure below shows how the VisiNaming Service might be used to name objects that make up an order entry system. This hypothetical order entry system organizes its namespace by geographic region, then by department, and so on. The VisiNaming Service allows you to organize the namespace in a hierarchical structure of `NamingContext` objects that can be traversed to locate a particular name. For example, the logical name `NorthAmerica/ShippingDepartment/Orders` could be used to locate an `Order` object.

**Figure 25** Naming scheme for an order entry system

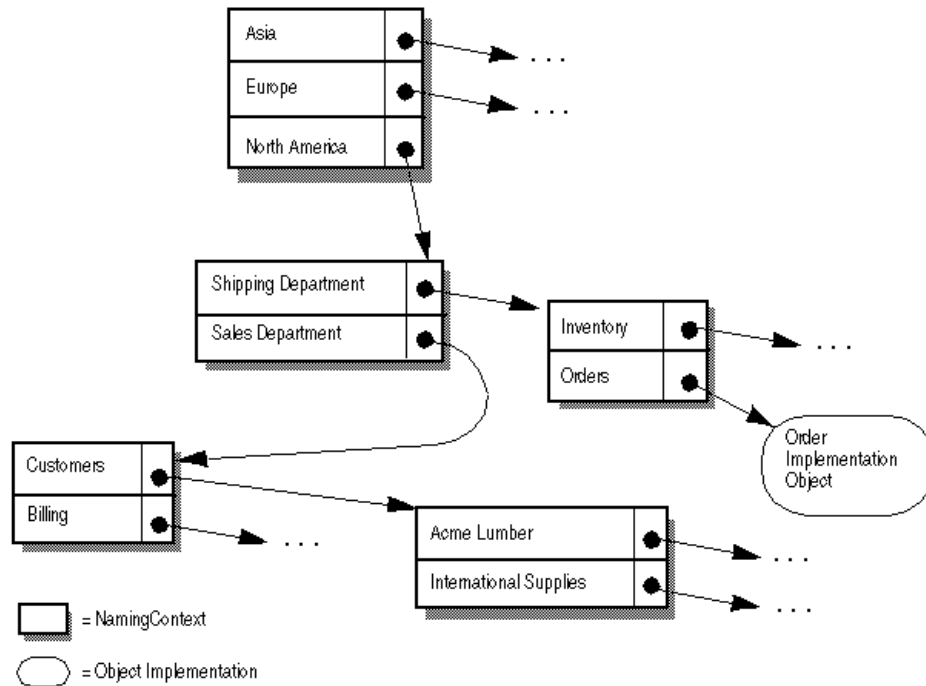

## Naming contexts

To implement the namespace shown above with the VisiNaming Service, each of the shadowed boxes in the diagram above, would be implemented by a `NamingContext` object. A `NamingContext` object contains a list of Name structures that have been bound to object implementations or to other `NamingContext` objects. Though a logical name may be bound to a `NamingContext`, it is important to realize that a `NamingContext` does not, by default, have a logical name associated with it nor is such a name required.

Object implementations use a `NamingContext` object to *bind* a name to an object that they offer. Client applications use a `NamingContext` to *resolve* a bound name to an object reference.

A `NamingContextExt` interface is also available which provides methods necessary for using stringified names.

## Naming context factories

A naming context factory provides the interface for *bootstrapping* the VisiNaming Service. It has operations for shutting down the VisiNaming Service and creating new contexts when there are none. Factories also have an additional API that returns the root context. The root context provides a very critical role as a reference point. This is the common starting point to store all data that are supposed to be publicly available.

Two classes are provided with the VisiNaming Service that allow you to create a namespace; the default naming context factory and the extended naming context factory. The default naming context factory creates an empty namespace that has no root `NamingContext`. You may find it more convenient to use the extended naming context factory because it creates a namespace with a root `NamingContext`.

You must obtain at least one of these `NamingContext` objects before your object implementations can bind names to their objects and before client applications can resolve a name to an object reference.

Each of the `NamingContext` objects shown in the figure above could be implemented within a single *name service* process, or they could be implemented within as many as five distinct name server processes.

## Names and NameComponent

A `CosNaming::Name` represents an identifier that can be bound to an object implementation or a `CosNaming::NamingContext`. A `Name` is not simply a string of alphanumeric characters; it is a sequence of one or more `NameComponent` structures.

Each `NameComponent` contains two attribute strings, `id` and `kind`. The Naming service does not interpret or manage these strings, except to ensure that each `id` and `kind` is unique within a given `NamingContext`.

The `id` and `kind` attributes are strings which uniquely identify the object to which the name is bound. The `kind` member adds a descriptive quality to the name. For example, the name "Inventory.RDBMS" has an `id` member of "Inventory" and a `kind` member of "RDBMS."

```
module CosNaming
    typedef string Istring;
    struct NameComponent {
        Istring id;
        Istring kind;
    };
    typedef sequence<NameComponent> Name;
};
```

The `id` and `kind` attributes of `NameComponent` in the code example above, must be a character from the ISO 8859-1 (Latin-1) character set, excluding the null character (0x00) and other non-printable characters. Neither of the strings in `NameComponent` can exceed 255 characters. Furthermore, the VisiNaming Service does not support `NameComponent` which uses wide strings.

### Note

The `id` attribute of a `Name` cannot be an empty string, but the `kind` attribute can be an empty string.

## Name resolution

Your client applications use the `NamingContext` method `resolve` to obtain an object reference, given a logical `Name`. Because a `Name` consists of one or more `NameComponent` objects, the resolution process requires that all of the `NameComponent` structures that make up the `Name` be traversed.

### Stringified names

Because the representation of `CosNaming::Name` is not in a form that is readable or convenient for exchange, a stringified name has been defined to resolve this problem. A stringified name is a one-to-one mapping between a string and a `CosNaming::Name`. If two `CosNaming::Name` objects are equal, then their stringified representations are equal and vice versa. In a stringified name, a forward slash (/) serves as a name component separator; a period (.) serves as the `id` and `kind` attributes separator; and a backslash (\) serves as an escape character. By convention a `NameComponent` with an empty `kind` attribute does not use a period (for example, `Order`).

```
"MF.Company/Engineering.Department/Printer.Resource"
```

### Note

In the following examples, `NameComponent` structures are given in their stringified representations.

### Simple and complex names

A *simple name*, such as `Billing`, has only a single `NameComponent` and is always resolved relative to the target naming context. A simple name may be bound to an object implementation or to a `NamingContext`.

A *complex name*, such as `NorthAmerica/ShippingDepartment/Inventory`, consists of a sequence of three `NameComponent` structures. If a complex name consisting of  $n$  `NameComponent` objects has been bound to an object implementation, then the first  $(n-1)$  `NameComponent` objects in the sequence must each resolve to a `NamingContext`, and the last `NameComponent` object must resolve to an object implementation.

If a `Name` is bound to a `NamingContext`, each `NameComponent` structure in the sequence must refer to a `NamingContext`.

The code sample below shows a complex name, consisting of three components and bound to a CORBA object. This name corresponds to the stringified name, `NorthAmerica/SalesDepartment/Order`. When resolved within the topmost naming context, the first two components of this complex name resolve to `NamingContext` objects, while the last component resolves to an object implementation with the logical name "Order."

```
...
// Name stringifies to "NorthAmerica/SalesDepartment/
Order"
NameComponent[] continentName = { new
NameComponent("NorthAmerica", "") };
NamingContext continentContext =

rootNamingContext.bind_new_context(continentName);
NameComponent[] departmentName = { new
NameComponent("SalesDepartment", "") };
NamingContext departmentContext =

continentContext.bind_new_context(departmentName);
```

```

NameComponent[] objectName = { new NameComponent("Order",
    "") };
departmentContext.rebind(objectName, myPOA.servant_to_refer
    ence(managerServant));
...

```

## Running the VisiNaming Service

The VisiNaming Service can be started with the following commands. Once you have started the Naming service, you may browse its contents by using the VisiBroker Console.

### Installing the VisiNaming Service

The VisiNaming Service is installed automatically when you install VisiBroker. It consists of a `nameserv` launcher program and Java class files which are stored in the `vbjorb.jar` file.

### Configuring the VisiNaming Service

In previous versions of VisiBroker, the VisiNaming Service maintained persistence by logging any modifying operations to a flat-file. From version 4.0 onward, the VisiNaming Service works in conjunction with backing store adapters. It is important to note that not all backing store adapters support persistence. The default `InMemory` adapter is non-persistent while all the other adapters are. For more details about adapters, see [“Pluggable backing store”](#).

#### Note

A Naming Server is designed to register itself with the Smart Agent. In most cases you should to run the Smart Agent to bootstrap the VisiNaming Service. This allows clients to retrieve the initial root context by calling the `resolve_initial_references` method. The resolving function works through the Smart Agent for the retrieval of the required references. Similarly, Naming Servers that participate in a federation also uses the same mechanism for setting up a federation.

For more information about the Smart Agent, see [“Using the Smart Agent”](#).

### Starting the VisiNaming Service

You can start the VisiNaming Service by using the `nameserv` launcher program in the `/bin` directory. The `nameserv` launcher uses the `com.inprise.vbroker.naming.ExtFactory` factory class by default.

#### UNIX

```
nameserv [driver_options] [nameserv_options] <ns_name> &
```

#### Windows

```
start nameserv [driver_options] [nameserv_options]
<ns_name>
```

See “[General options](#)” for descriptions of the driver options available to all of the VisiBroker programmer tools.

nameserv_option	Description
-?, -h, -help, -usage	Print out the usage information.
-config <properties_file>	Use <properties_file> as the configuration file when starting up the VisiNaming Service.
<ns_name>	The name to use for this VisiNaming Service. This is optional; the default name is NameService.

To force the VisiNaming Service to start on a particular port, the VisiNaming Service must be started with the following command line option:

```
prompt> nameserv -J-
Dvbroker.se.iiop_tp.scm.iiop_tp.listener.port=<port
number>
```

The default name for VisiNaming is “NameService”, if you want to specify a name other than this, you can start VisiNaming in the following way:

```
prompt> nameserv -J-
Dvbroker.se.iiop_tp.scm.iiop_tp.listener.port=<port
number> <ns_name>
```

## Starting the VisiNaming Service with the vbj command

The VisiNaming Service can be started using vbj.

```
prompt>vbj com.inprise.vbroker.naming.ExtFactory <ns_name>
```

# Invoking the VisiNaming Service from the command line

The VisiNaming Service Utility (nsutil) provides the ability to store and retrieve bindings from the command line.

## Configuring nsutil

To use nsutil, first configure the Naming Service instance using the following commands:

```
prompt>nameserv <ns_name>
prompt>nsutil -VBJprop <option> <cmd> [args]
```

Option	Description
ns_name	Configure the Naming service to contact
SVCnameroot=<ns_name>	<b>Note:</b> Before using SVCnameroot, you must run OSAgent.
ORBInitRef=NameService=<url>	File name or URL, prefixed by its type, which may be (corbaloc:, corbaname:, file:, ftp:, http:, or ior:). For example, to assign a file in a local directory, the ns_config string would be: -VBJprop ORBInitRef=NameService=<file://<path>/ns.ior>
cmd	Any CosNaming operation, and, in addition, ping and shutdown.

## Running nsutil

The VisiNaming Service Utility supports all the CosNaming operations as well as three additional commands. The CosNaming operations are:

cmd	Parameter(s)
bind	name objRef
bind_context	name ctxRef
bind_new_context	name
destroy	name
list	[name1 name2 name3...]
new_context	No parameter
rebind	name objRef
rebind_context	name ctxRef
resolve	name
unbind	name

### Note

For the operations `destroy` and `list`, the `name` parameter must refer to existing naming contexts. For the operation `list` only, there can be zero or more naming contexts, whose contents will be listed. In the case where no naming context is specified, the content of the root naming context will be listed.

The additional `nsutil` commands are:

cmd	Parameter	Description
ping	name	Resolves the stringified <code>name</code> and contacts the object to see if it is still alive.
shutdown	<naming context factoryname or stringified ior>	Shuts the VisiNaming Service down gracefully from the command line. The mandatory parameter of this operation specifies either the naming context factory's name as registered with the osagent or the stringified IOR of the factory.
unbind_from_cluster	name objRef	Unbinds a specific object in an implicit cluster. The <code>name</code> is the object's logical name and the <code>objRef</code> is the stringified object reference that is to be unbound.

To run an operation from the `nsutil` command, place the operation name and its parameters as the `<cmd>` parameter. For example:

```
prompt>nsutil -VBJprop ORBInitRef=NameService=file://
ns.ior resolve myName
```

## Shutting down the VisiNaming Service using nsutil

To shut down the VisiNaming Service using `nsutil`, use the `shutdown` command:

```
prompt>nsutil -VBJprop ORBInitRef=NameService=file://
ns.ior shutdown <ns_name>
```

## Bootstrapping the VisiNaming Service

There are three ways to start a client application to obtain an initial object reference to a specified VisiNaming Service. You can use the following command-line options when starting the VisiNaming Service:

- ORBInitRef
- ORBDefaultInitRef
- SVCnameroot

The following example illustrates how to use these options.

Suppose there are three VisiNaming Services running on the host `TestHost`: `ns1`, `ns2`, and `ns3`, running on the ports 20001, 20002 and 20003 respectively. And there are three server applications: `sr1`, `sr2`, `sr3`. Server `sr1` binds itself in `ns1`, Server `sr2` binds itself in `ns2`, and server `sr3` in `ns3`.

### Calling `resolve_initial_references`

The VisiNaming Service provides a simple mechanism by which the `resolve_initial_references` method can be configured to return a common naming context. You use the `resolve_initial_references` method which returns the root context of the Naming Server to which the client program connects.

```
...
    org.omg.CORBA.ORB orb = org.omg.CORBA.ORB.init(args,
null);
    org.omg.CORBA.Object rootObj =
orb.resolve_initial_references("NameService");
...
```

### Using `-DSVCnameroot`

You use the `-DSVCnameroot` option to specify into which VisiNaming Service instance (especially important if several unrelated Naming service instances are running) you want to bootstrap.

For instance, if you want to bootstrap into `ns1`, you would start your client program as:

```
vbj -DSVCnameroot=ns1 <client_application>
```

You can then obtain the root context of `ns1` by calling the `resolve_initial_references` method on an ORB reference inside your client application as illustrated below. The Smart Agent must be running in order to use this option.

### Using `-DORBInitRef`

You can use either the `corbaloc` or `corbaname` URL naming schemes to specify which VisiNaming Service you want to bootstrap. This method does not rely on the Smart Agent.

### Using a `corbaloc` URL

If you want to bootstrap using VisiNaming Service `ns2`, then start your client application as follows:



```
vbj -DORBInitRef=NameService=corbaloc::TestHost:20002/
NameService <client_application>
```

You can then obtain the root context of `ns2` by calling the `resolve_initial_references` method on the VisiBroker ORB reference inside your client application as illustrated in the example above.

### Note

The deprecated `iioploc` and `iiopname` URL schemes are implemented by `corbaloc` and `corbaname`, respectively. For backwards compatibility, the old schemes are still supported.

## Using a corbaname URL

If you want to bootstrap into `ns3` by using `corbaname`, then you should start your client program as:

```
vbj -DORBInitRef=NameService=corbaname::TestHost:20003/
<client_application>
```

You can then obtain the root context of `ns3` by calling the `resolve_initial_references` method on the VisiBroker ORB reference inside your client application as illustrated above.

## -DORBDefaultInitRef

You can use either a `corbaloc` or `corbaname` URL to specify which VisiNaming Service you want to bootstrap. This method does not rely on the Smart Agent.

## Using -DORBDefaultInitRef with a corbaloc URL

If you want to bootstrap into `ns2`, then you should start your client program as:

```
vbj -DORBDefaultInitRef=corbaloc::TestHost:20002
<client_application>
```

You can then obtain the root context of `ns2` by calling the `resolve_initial_references` method on the VisiBroker ORB reference inside your client application as illustrated in the sample above.

The following is an example of how to set up multiple VisiNaming Services using `corbaloc`:

```
vbj -DORBDefaultInitRef=corbaloc::bart:20000, :Bart:20001,
:Bart:20002 -DORBpropStorage=clt.props
<client_application>
```

## Using -DORBDefaultInitRef with corbaname

The combination of `-ORBDefaultInitRef` or `-DORBDefaultInitRef` and `corbaname` works differently from what is expected. If `-ORBDefaultInitRef` or `-DORBDefaultInitRef` is specified, a slash and the stringified object key is always appended to the `corbaname`.

If the URL is `corbaname::TestHost:20002`, then by specifying `-DORBDefaultInitRef`, `resolve_initial_references` in Java will result in a new URL: `corbaname::TestHost:20003/NameService`.

## NamingContext

This object is used to contain and manipulate a list of names that are bound to VisiBroker ORB objects or to other NamingContext objects. Client applications use this interface to resolve or list all of the names within that context. Object implementations use this object to bind names to object implementations or to bind a name to a NamingContext object. The sample below shows the IDL specification for the NamingContext.

```
Module CosNaming {
    interface NamingContext {
        void bind(in Name n, in Object obj)
            raises(NotFound, CannotProceed, InvalidName,
AlreadyBound);
        void rebind(in Name n, in Object obj)
            raises(NotFound, CannotProceed, InvalidName);
        void bind_context(in Name n, in NamingContext nc)
            raises(NotFound, CannotProceed, InvalidName,
AlreadyBound);
        void rebind_context(in Name n, in NamingContext NC)
            raises(NotFound, CannotProceed, InvalidName);
        Object resolve(in Name n)
            raises(NotFound, CannotProceed, InvalidName);
        void unbind(in Name n)
            raises(NotFound, CannotProceed, InvalidName);
        NamingContext new_context();
        NamingContext bind_new_context(in Name n)
            raises(NotFound, CannotProceed, InvalidName,
AlreadyBound);
        void destroy()
            raises(NotEmpty);
        void list(in unsigned long how_many,
                out BindingList bl,
                out BindingIterator bi);
    };
};
```

## NamingContextExt

The NamingContextExt interface, which extends NamingContext, provides the operations required to use stringified names and URLs.

```
Module CosNaming {
    interface NamingContextExt : NamingContext {
        typedef string StringName;
        typedef string Address;
        typedef string URLString;
        StringName to_string(in Name n)
            raises(InvalidName);
        Name to_name(in StringName sn)
            raises(InvalidName);
        exception InvalidAddress {};
        URLString to_url(in Address addr, in StringName sn)
            raises(InvalidAddress, InvalidName);
        Object resolve_str(in StringName n)
            raises(NotFound, CannotProceed, InvalidName);
    };
};
```

## Default naming contexts

A client application can specify a *default naming context*, which is the naming context that the application will consider to be its *root* context. Note that the default naming context is the *root* only in relation to this client application and, in fact, it can be contained by another context.

### Obtaining the default naming context

Java client applications can connect to the VisiNaming Service by using the `resolve_initial_references` method in the ORB interface. To use this feature, the `SVCnameroot` or `ORBInitRef` parameters must be specified when the client is started.

For example, to start a Java application named `ClientApplication` that intends to use the naming context `Inventory` as its default naming context, you could enter the following command:

```
prompt> vbj -DSVCnameroot=NorthAmerica/ShippingDepartment/
Inventory \
    ClientApplication
```

In the example, `NorthAmerica` is the server name and `ShippingDepartment/Inventory` is the stringified name from the root context.

#### Note

When using the `vbj` command, all `-D` properties must appear before the Java class name.

### Obtaining naming context factories

A naming service client can get a reference to the naming context factory by resolving the initial reference of the factory as follows:

```
ExtendedNamingContextFactory myFactory =
    ExtendedNamingContextFactoryHelper.narrow(
        orb.resolve_initial_reference("VisiNamingContextFactory")
    );
```

If `osagent` is running on the network, then such a client must be started as follows:

```
vbj -DSVCnameroot=<ns_name> Client
```

If there is no `osagent` running on the network, then the client must be started as shown in the following example:

```
vbj -DORBInitRef=VisiNamingContextFactory=
    corbaloc::<host>:<port>/VisiNamingContextFactory
Client
```

## VisiNaming Service properties

The following tables list the VisiNaming Service properties:

Property	Default	Description
<code>vbroker.naming.adminPwd</code>	<code>inprise</code>	Password required by administrative VisiBroker Naming service operations.

Property	Default	Description
<code>vbroker.naming.enableSlave</code>	0	If 1, enables master/slave naming services configuration. See <a href="#">“VisiNaming Service Clusters for Failover and Load Balancing”</a> for information about configuring master/slave naming services.
<code>vbroker.naming.iorFile</code>	<code>ns.ior</code>	This property specifies the full path name for storing the Naming service IOR. If you do not set this property, the Naming service will try to output its IOR into a file named <code>ns.ior</code> in the current directory. The Naming service silently ignores file access permission exceptions when it tries to output its IOR.
<code>vbroker.naming.logUpdate</code>	false	<p>This property allows special logging for all of the update operations on the <code>CosNaming::NamingContext</code>, <code>CosNamingExt::Cluster</code>, and <code>CosNamingExt::ClusterManager</code> interfaces.</p> <p>The <code>CosNaming::NamingContext</code> interface operations for which this property is effective are:</p> <pre>bind, bind_context, bind_new_context, destroy, rebind, rebind_context, unbind</pre> <p>The <code>CosNamingExt::Cluster</code> interface operations for which this property is effective are:</p> <pre>bind, rebind, unbind, destroy.</pre> <p>The <code>CosNamingExt::ClusterManager</code> interface operation for which this property is effective is:</p> <pre>create_cluster</pre> <p>When this property value is set to <code>true</code> and any of the above methods is invoked, the following log message is printed (the output shows a bind operation being executed):</p> <pre>00000007,5/26/04 10:11 AM,127.0.0.1,00000000, VBJ-Application,VBJ ThreadPool Worker,INFO,  OPERATION NAME : bind CLIENT END POINT : Connection[socket=Socket [addr=/127.0.0.1, port=2026, localport=1993]] PARAMETER 0 : [(Tom.LoanAccount)] PARAMETER 1 : Stub[repository_id=IDL:Bank/ LoanAccount:1.0, key=TransientId[poaName=/, id={4 bytes: (0) (0) (0) (0)},sec=505,usec=990917734, key_string=%00VB%01%00%00%00%02/%00%20%20%00%00%00% 04%00%00%00%00%00%00%01%f9;%104f],codebase=null]</pre>

For more information see [“Object Clusters”](#).

Property	Default	Description
<code>vbroker.naming.enableClusterFailover</code>	true	When set to <code>true</code> , it specifies that an interceptor be installed to handle fail-over for objects that were retrieved from the VisiNaming Service. In case of an object failure, an attempt is made to transparently reconnect to another object from the same cluster as the original.

Property	Default	Description
<code>vbroker.naming.propBindOn</code>	0	If 1, the implicit clustering feature is turned on.
<code>vbroker.naming.smrr.pruneStaleRef</code>	1	This property is relevant when the name service cluster uses the Smart Round Robin criterion. When this property is set to 1, a stale object reference that was previously bound to a cluster with the Smart Round Robin criterion will be removed from the bindings when the name service discovers it. If this property is set to 0, stale object reference bindings under the cluster are not eliminated. However, a cluster with Smart Round Robin criterion will always return an active object reference upon a <code>resolve()</code> or <code>select()</code> call if such an object binding exists, regardless of the value of the <code>vbroker.naming.smrr.pruneStaleRef</code> property. By default, the implicit clustering in the name service uses the Smart Round Robin criterion with the property value set to 1. If set to 2, this property disables the clearing of stale references completely, and the responsibility of cleaning up the bindings belongs to the application, rather than to VisiNaming.

For more information see [“VisiNaming Service Clusters for Failover and Load Balancing”](#).

Property	Default	Description
<code>vbroker.naming.enableSlave</code>	0	See <a href="#">“VisiNaming Service properties”</a> .
<code>vbroker.naming.slaveMode</code>	No default. Can be set to <code>cluster</code> or <code>slave</code> .	This property is used to configure VisiNaming Service instances in the cluster mode or in the master/slave mode. The <code>vbroker.naming.enableSlave</code> property must be set to 1 for this property to take effect.  Set this property to <code>cluster</code> to configure VisiNaming Service instances in the cluster mode. VisiNaming Service clients will then be load balanced among the VisiNaming Service instances that comprise the cluster. Client failover across these instances are enabled.  Set this property to <code>slave</code> to configure VisiNaming Service instances in the master/slave mode. VisiNaming Service clients will always be bound to the master server if the master is running but failover to the slave server when the master server is down.
<code>vbroker.naming.serverClusterName</code>	null	This property specifies the name of a VisiNaming Service cluster. Multiple VisiNaming Service instances belong to a particular cluster (for example, <code>clusterXYZ</code> ) when they are configured with the cluster name using this property.
<code>vbroker.naming.serverNames</code>	null	This property specifies the factory names of the VisiNaming Service instances that belong to a cluster. Each VisiNaming Service instance within the cluster should be configured using this property to be aware of all the instances that constitute the cluster. Each name in the list must be unique. This property supports the format:  <code>vbroker.naming.serverNames=</code> <code>Server1:Server2:Server3</code>  See the related property, <code>vbroker.naming.serverAddresses</code> .

Property	Default	Description
<code>vbroker.naming.serverAddresses</code>	<code>null</code>	This property specifies the host and listening port for the VisiNaming Service instances that comprise a VisiNaming Service cluster. The order of VisiNaming Service instances in this list must be identical to that of the related property <code>vbroker.naming.serverNames</code> , which specifies the names of the VisiNaming Service instances that comprise a VisiNaming Service Cluster. This property supports the format:  <pre>vbroker.naming.serverAddresses=host1:port1;host2:port2;host3:port3</pre>
<code>vbroker.naming.anyServiceOrder</code>  (To be set on VisiNaming Service clients)	<code>false</code>	This property must be set to <code>true</code> on the VisiNaming Service client to utilize the load balancing and failover features available when VisiNaming Service instances are configured in the VisiNaming Service cluster mode. The following is an example of how to use this property:  <pre>vbj -Dvbroker.naming.anyServiceOrder=true Client</pre>

## Logging properties

The property `vbroker.naming.logLevel` used in previous versions is no longer supported. See [“Debug Logging Properties”](#) for supported properties that you can use to configure the logger in VisiNaming. The source name for VisiNaming log filter is "naming".

For example, to enable the full debug logs in VisiNaming for all source names, set the following properties:

```
vbroker.log.enable=true
vbroker.log.logLevel=debug
```

To enable only the debug logs printed by the "naming" source name, set the following properties:

```
vbroker.log.enable=true
vbroker.log.default.filter.all.enable=false
vbroker.log.default.filter.register=naming
vbroker.log.default.filter.naming.enable=true
vbroker.log.default.filter.naming.logLevel=debug
```

## Pluggable backing store

The VisiNaming Service maintains its namespace by using a pluggable backing store. Whether or not the namespace is persistent, depends on how you configure the backing store: to use JDBC adapter, the Java Naming and Directory Interface (JNDI, which is certified for LDAP), or the default, in-memory adapter.

### Types of backing stores

The types of backing store adapters supported are:

- In-memory adapter
- JDBC adapter for relational databases
- DataExpress adapter

- JNDI (for LDAP only)

### Note

For an example using pluggable adapters, see the code located in the directory:

```
<install dir>/vbroker/examples/ins/pluggable_adaptors
```

### In-memory adapter

The in-memory adapter keeps the namespace information in memory and is not persistent. This is the adapter used by the VisiNaming Service by default.

### JDBC adapter

Relational databases are supported via JDBC. The following databases have been certified to work with the VisiNaming Service JDBC adapter:

- JDataStore 7.05
- Oracle 10G, Release 2 (10.20.1.0)
- Oracle 11G, Release 2 (11.20.1.0)
- Microsoft SQLServer 2008 R2

Multiple VisiNaming Service instances can use the same back-end relational database if one of these is true:

- The VisiNaming Service instances are independent of each other and use different factory names, or,
- The VisiNaming Service instances are all part of the same VisiNaming Service Cluster.

### DataExpress adapter

In addition to the JDBC adapter, there is also a DataExpress adapter which allows you to access JDataStore databases natively. It is much faster than accessing JDataStore through JDBC, but the DataExpress adapter has some limitations. It only supports a local database running on the same machine as the Naming Server. To access a remote JDataStore database, you must use the JDBC adapter.

### JNDI adapter

A JNDI adapter is also supported. Sun's JNDI (Java Naming and Directory Interface) provides a standard interface to multiple naming and directory services throughout the enterprise. JNDI has a Service Provider Interface (SPI) with which different naming and service vendors must conform. There are different SPI modules available for Netscape LDAP server, Novell NDS, WebLogic Tengah, etc. By supporting JNDI, the VisiNaming Service allows you to have portable access to these naming and directory services and other future SPI providers.

The VisiNaming JNDI adapter is certified with the following LDAP implementation:

- OpenLdap 2.4.23

You must use Sun and Netscape JNDI Driver version 1.2 to leverage LDAP.

## Configuration and use

Backing store adapters are pluggable, which means that the type of adapter used can be specified by user-defined information stored in a configuration (properties) file used when starting up the VisiNaming Service. All adapters, except the in-memory one, provide persistence. The in-memory adapter

should be used when you want to use a lightweight VisiNaming Service which keeps its namespace entirely in memory.

### Note

For the current version of the VisiNaming Service, you cannot change settings while the VisiNaming Service is running. To change a setting, you must bring down the service, make the change to the configuration file, and then restart the VisiNaming Service.

### Properties file

As with the VisiNaming Service in general, which adapter is to be used and any specific configuration of it is handled in VisiNaming Service properties file. The default properties common to all adapters are:

Property	Default	Description
<code>vbroker.naming.backingStoreType</code>	InMemory	Specifies the Naming service adapter type to use. This property specifies which type of backing store you want the VisiNaming Service to use. The valid options are: InMemory, JDBC, Dx, JNDI. The default is InMemory.
<code>vbroker.naming.cacheOn</code>	0	Specifies whether to use the Naming Service cache. A value of 1 (one) enables caching.
<code>vbroker.naming.cache.connectString</code>		This property is required when the Naming Service cache is enabled ( <code>vbroker.naming.cacheOn=1</code> ) and the Naming Service instances are configured in Cluster or Master/Slave mode. It helps locate an Event Service/VisiNotify instance in the format <code>&lt;hostname&gt;:&lt;port&gt;</code> . For example:  <code>vbroker.naming.cache.connectString=127.0.0.1:14500</code>  See <a href="#">“Caching facility”</a> for details about enabling the caching facility and setting the appropriate properties.
<code>vbroker.naming.cache.size</code>	2000	This property specifies the size of the Naming Service cache. Higher values will mean caching of more data at the cost of increased memory consumption.
<code>vbroker.naming.cache.timeout</code>	0 (no limit)	This property specifies the time, in seconds, since the last time a piece of data was accessed, after which the data in the cache will be purged in order to free memory. The cached entries are deleted in LRU (Least Recently Used) order.

### JDBC Adapter properties

The following sections describe the JDBC Adapter properties.

```
vbroker.naming.backingStoreType
```

This property should be set to JDBC. The `poolSize`, `jdbcDriver`, `url`, `loginName`, and `loginPwd` properties must also be set for the JDBC adapter.

```
vbroker.naming.jdbcDriver
```



This property specifies the JDBC driver that is needed to access the database used as your backing store. The VisiNaming Service loads the appropriate JDBC driver specified. The default is the Java DataStore JDBC driver. The table below gives examples of JDBC drivers. Note that some of them may not be certified.

JDBC driver class name	Description
<code>com.borland.datastore.jdbc.DataStoreDriver</code>	JDataStore JDBC Driver 007.005.009.000
<code>com.sybase.jdbc2.jdbc.SybDriver</code>	Sybase driver (jConnect Version 5.0)
<code>oracle.jdbc.driver.OracleDriver</code>	Oracle driver (using classes12.zip Version 10.2.0.1.0)
<code>interbase.interclient.Driver</code>	Interbase driver (using InterClient.jar Version 4.3.3)
<code>weblogic.jdbc.mssqlserver4.Driver</code>	WebLogic MS SQLServer JDBC driver (Version 5.1)
<code>com.ibm.db2.jcc.DB2Driver</code>	IBM DB2 driver (using db2jcc.jar Version 1.2.117)
<code>com.microsoft.sqlserver.jdbc.SQLServerDriver</code>	Microsoft SQL Server 2008 JDBC Driver 1.1

`vbroker.naming.minReconInterval`

This property sets the database reconnection retry time by the Naming Service in seconds. The default value is 30. The Naming Service will ignore the request and throw a `CannotProceed` exception if the time interval between this request and the last reconnection time is less than the value set by this property. The valid value for this property is 0 (zero) or a greater integer. If the property value is 0 (zero), the VisiNaming Service will try to reconnect to the database for every request, once disconnected.

`vbroker.naming.loginName`

This property is the login name associated with the database. The default is `VisiNaming`.

`vbroker.naming.loginPwd`

This property is the login password associated with the database. The default value is `VisiNaming`.

`vbroker.naming.poolSize`

This property specifies the number of database connections in your connection pool when using the JDBC Adapter as our backing store. The default value is 5, but it can be increased to whatever value the database can handle. If you expect many requests will be made to the VisiNaming Service, you should make this value larger.

`vbroker.naming.url`

This property specifies the location of the database which you want to access. The setting is dependent on the database in use. The default is `JDataStore` and the database location is the current directory and is called `rootDB.jds`. You can use any name you like not necessarily `rootDB.jds`. The configuration file needs to be updated accordingly.

URL value	Description
<code>jdbc:borland:dslocal:&lt;db_name&gt;</code>	JDataStore URL
<code>jdbc:sybase:Tds:&lt;host&gt;:&lt;port&gt;/&lt;db_name&gt;</code>	Sybase URL
<code>jdbc:oracle:thin:@&lt;host&gt;:&lt;port&gt;:&lt;sid&gt;</code>	Oracle URL
<code>jdbc:interbase://&lt;server&gt;/&lt;full_db_path&gt;</code>	Interbase URL
<code>jdbc:weblogic:mssqlserver4:&lt;db_name&gt;@&lt;host&gt;:&lt;port&gt;</code>	WebLogic MS SQLServer URL

URL value	Description
<code>jdbc:db2://&lt;host_name&gt;:&lt;port-number&gt;/&lt;db_name&gt;</code>	IBM DB2 URL
<code>&lt;full_path_JDataStore_db&gt;</code>	DataExpress URL for the native driver

If you are using InterBase, you should start InterServer before accessing InterBase via JDBC. If the InterBase server resides on the local host, specify `<server>` as `localhost`; otherwise specify it as the host name. If the InterBase database resides on Windows, specify the `<full_db_path>` as `driver: \\dir1\dir2\db.gdb` (the first backslash [`\`] is to escape the second backslash [`\`]). If the InterBase database resides on UNIX, specify the `<full_db_path>` as `\dir1\dir2\db.gdb`.

You can get more information from <http://www.embarcadero.com/products/interbase>.

Before you access DB2 via JDBC, you must register the database by its alias `<db_name>` using the Client Configuration Assistant. After the database has been registered, you do not have to specify `<host>` and `<port>` for the `vbroker.naming.url` property.

If the JDataStore database resides on Windows, the `<full path of the JDataStore database>` should be `Driver: \\dir1\dir2\db.jds` (the first backslash [`\`] is to escape the second backslash [`\`]). If the JDataStore database resides on UNIX, the `<full path of the JDataStore database>` should be `/dir1/dir2/db.jds`.

## DataExpress Adapter properties

The following table describes the DataExpress Adapter properties:

Property	Description
<code>vbroker.naming.backingStoreType</code>	This property should be set to <code>Dx</code> .
<code>vbroker.naming.loginName</code>	This property is the login name associated with the database. The default is <code>VisiNaming</code> .
<code>vbroker.naming.loginPwd</code>	This property is the login password associated with the database. The default value is <code>VisiNaming</code> .
<code>vbroker.naming.url</code>	This property specifies the location of the database.

## JNDI adapter properties

The following is an example of settings that can appear in the configuration file for a JNDI adapter:

Setting	Description
<code>vbroker.naming.backingStoreType=JNDI</code>	This setting specifies the backing store type which is JNDI for the JNDI adapter.
<code>vbroker.naming.loginName=&lt;user_name&gt;</code>	The user login name on the JNDI backing server.
<code>vbroker.naming.loginPwd=&lt;password&gt;</code>	The password for the JNDI backing server user.
<code>vbroker.naming.jndiInitialFactory=com.sun.jndi.ldap.LdapCtxFactory</code>	This setting specifies the JNDI initial factory.
<code>vbroker.naming.jndiProviderURL=ldap://&lt;hostname&gt;:389/&lt;initial root context&gt;</code>	This setting specifies the JNDI provider URL
<code>vbroker.naming.jndiAuthentication=simple</code>	This setting specifies the JNDI authentication type supported by the JNDI backing server.

## Configuration for OpenLDAP

OpenLDAP is one of the supported VisiNaming back-end stores. When using OpenLDAP, additional configuration is required on the OpenLDAP server. You must perform the following actions:

- 1 Add `corba.schema` in the OpenLDAP server's config file (the default is `slapd.conf`). The `corba.schema` is included with your OpenLDAP server installation.
- 2 Add `openldap_ns.schema` in the OpenLDAP config file. `openldap_ns.schema` is provided with VisiBroker and is located in `<install-dir>/etc/ns_schema/`

### Note

The user must have the necessary privilege to add schemas/attributes to the Directory Server.

## Caching facility

By enabling the caching facility you can improve the performance of the Naming Service when it uses a backing store. For example, in the case of the JDBC adapter, directly accessing the database every time there is a resolve or bind operation is relatively slow. If you cache the results, you can reduce the number of times you access the database. You will only see improvement in the performance of the backing store if the same piece of data is accessed multiple times.

### Note

Multiple Naming Service instances can access the same backing store if they are configured in the Naming Service Cluster mode or in the Master/Slave mode. In order to use the caching facility in these two modes, each Naming Service instance must be specially configured using the `vbroker.naming.cache.connectString` property. The VisiBroker Event Service or VisiNotify is used to coordinate the caching facility amongst the various Naming Service instances.

To enable the caching facility set the following property in your configuration file:

```
vbroker.naming.cacheOn=1
```

If multiple Naming Service instances in Cluster or Master/Slave mode will access the cache, set the `vbroker.naming.cache.connectString` property so that the Naming Services can locate the Event Service (or VisiNotify).

The format for `vbroker.naming.cache.connectString` is:

```
vbroker.naming.cache.connectString=<host>:<port>
```

Where `<host>` is the hostname or IP address of the machine where VisiBroker Event Service is running and `<port>` is the port used by VisiBroker Event Service/VisiNotify (default is 14500 for Event Service and 14100 for VisiNotify).

For example:

```
vbroker.naming.cache.connectString=127.0.0.1:14500
```

or

```
vbroker.naming.cache.connectString=myhost:14100
```

If the host address is an IPv6 style address then enclose it in square brackets.

### Note

The VisiBroker Event Service (version 6.5 or later) should be started before starting the Naming Service instances. If VisiNotify is used instead, VisiNotify should be started. Start the Event Service/VisiNotify without any channel name (so the default name is used) before Naming Service instances are started.

If the cache needs tuning, set the following properties:

```
vbroker.naming.cache.size
vbroker.naming.cache.timeout
```

See [“Properties file”](#) for more information about the caching facility properties.

## Important Notes for users of Caching Facility

**Consistent configuration is very important.** It is extremely important to configure all Naming Service instances in a Cluster to use the Caching Facility in a consistent manner. Naming Service instances that constitute a Cluster must either **all** use the caching facility or **none** use it. If certain Naming Service instances use the caching facility while others do not, the behavior of the Cluster will be inconsistent. This is also true for Naming Services configured in the Master-Slave mode. If the Master is configured to use the caching facility, it is required that the Slave also be configured to use it, and vice versa.

**The distributed cache depends on the Event Service/VisiNotify.** If the Caching Facility is used in Naming Service Cluster mode (or the Master-Slave mode), the distributed cache needs synchronization across the multiple Naming Services instances. This is achieved using the Event Service (or VisiNotify). Please note that in such a configuration, the cached data might be stale. The quality of data would depend on the health of the Event Service/VisiNotify. Applications that do not find this acceptable are advised to avoid using the Caching Facility. It is advisable to perform tests to gauge the suitability of the distributed Caching Facility for a particular application.

## Object Clusters

VisiBroker supports a clustering feature which allows a number of object bindings to be associated with a single name. The VisiNaming Service can then perform load balancing among the different bindings in a cluster. You can decide on a load balancing criterion at the time a cluster is created. Clients, which subsequently resolve name-object bindings against a cluster, are load balanced amongst different cluster server members. These clusters of object bindings should not be confused with [“VisiNaming Service Clusters for Failover and Load Balancing”](#).

A cluster is a multi-bind mechanism that associates a Name with a group of object references. The creation of a cluster is done through a `ClusterManager` reference. At creation time, the `create_cluster` method for the `ClusterManager` takes in a string parameter which specifies the criterion to be used. This method returns a reference to a cluster, which you can add, remove, and iterate through its members. After deciding on the composition of a cluster, you can bind its reference with a particular name to any context in a VisiNaming Service. By doing so, subsequent resolve

operations against the Name will return a particular object reference in this cluster.

## Object Clustering criteria

The VisiNaming Service uses a `SmartRoundRobin` criterion with clusters by default. After a cluster has been created, its criterion cannot be changed. User-defined criteria are not supported, but the list of supported criteria will grow as time goes on. `SmartRoundRobin` performs some verifications to ensure that the CORBA object reference is an active one; that the object reference is referring to a CORBA server which is in a ready state.

### Cluster and ClusterManager interfaces

Although a cluster is very similar to a naming context, there are certain methods found in a context that are not relevant to a cluster. For example, it would not make sense to bind a naming context to a cluster, because a cluster should contain a set of object references, not naming contexts. However, a cluster interface shares many of the same methods with the `NamingContext` interface, such as `bind`, `rebind`, `resolve`, `unbind` and `list`. This common set of operations mainly pertains to operations on a group. The only cluster-specific operation is `pick`. Another crucial difference between the two is that a cluster does not support compound names. It can only use a single component name, because clusters do not have a hierarchical directory structure, rather it stores its object references in a flat structure.

**IDL Specification for the Cluster interface**

```

CosNamingExt module {
    typedef sequence<Cluster> ClusterList;
    enum ClusterNotFoundReason {
        missing_node,
        not_context,
        not_cluster_context
    };
    exception ClusterNotFound {
        ClusterNotFoundReason why;
        CosNaming::Name rest_of_name;
    };
    exception Empty {};
    interface Cluster {
        Object select() raises(Empty);
        void bind(in CosNaming::NameComponent n, in Object
obj)
            raises(CosNaming::NamingContext::CannotProceed,
                CosNaming::NamingContext::InvalidName,
                CosNaming::NamingContext::AlreadyBound);
        void rebind(in CosNaming::NameComponent n, in Object
obj)
            raises(CosNaming::NamingContext::CannotProceed,
                CosNaming::NamingContext::InvalidName);
        Object resolve(in CosNaming::NameComponent n)
            raises(CosNaming::NamingContext::NotFound,
                CosNaming::NamingContext::CannotProceed,
                CosNaming::NamingContext::InvalidName);
        void unbind(in CosNaming::NameComponent n)
            raises(CosNaming::NamingContext::NotFound,
                CosNaming::NamingContext::CannotProceed,
                CosNaming::NamingContext::InvalidName);
        void destroy()
            raises(CosNaming::NamingContext::NotEmpty);
        void list(in unsigned long how_many,
            out CosNaming::BindingList bl,
            out CosNaming::BindingIterator BI);
    };
};

```

**IDL Specification for the ClusterManager interface**

```

CosNamingExt module {
    interface ClusterManager
        Cluster create_cluster(in string algo);
        Cluster find_cluster(in CosNaming::NamingContext
ctx,
            in CosNaming::Name n)
            raises(ClusterNotFound,
                CosNaming::NamingContext::CannotProceed,
                CosNaming::NamingContext::InvalidName);
        Cluster find_cluster_str(in CosNaming::NamingContext
ctx, in string n)
            raises(ClusterNotFound,
                CosNaming::NamingContext::CannotProceed,
                CosNaming::NamingContext::InvalidName);
        ClusterList clusters();
    };
};

```

## IDL Specification for the NamingContextExtExtended interface

The NamingContextExtExtended interface, which extends NamingContextExt, provides some operations required to remove an object reference from an implicit cluster. You must narrow a NamingContext to NamingContextExtExtended in order to use these operations. Note that these operations are proprietary to VisiBroker only.

```
module CosNamingExt {
    interface NamingContextExtExtended : NamingContextExt {
        void unbind_from_cluster(in Name n, in Object obj)
            raises(NotFound, CannotProceed, InvalidName);
        boolean is_ncluster_type(in Name n, out Object
            cluster)
            raises(NotFound, CannotProceed, InvalidName);
    };
}

unbind_from_cluster()
```

The unbind\_from\_cluster() method allows user to unbind a specific object in a cluster. The object's logical name (such as "London.Branch/Jack.SavingAccount") and the object reference to be unbound need to be passed into this method. Whenever the number of objects in the cluster reaches zero, the cluster is deleted as well.

This method is useful when automatic pruning of stale object references in a cluster is not required. Call this method to unbind an object in a cluster based on the application's specific rules.

### Note

The unbind\_from\_cluster() method can only be used when the VisiNaming Service is running in the implicit clustering mode and automatic pruning of stale object reference is disabled. This means that the following two properties must be set at the VisiNaming Service side:

```
vbroker.naming.smrr.pruneStaleRef=0
vbroker.naming.propBindOn=1
```

```
is_ncluster_type()
```

The is\_ncluster\_type() method lets you check whether a context is of a cluster type. The object's logical name need to be passed into this method. It returns true when the context is a cluster type and set the cluster object in the second argument value. It returns false when the context is not a cluster type and set the second argument value to null.

## Creating an object cluster

To create a cluster, use the Cluster Manager interface. A single ClusterManager object is automatically created when a Naming Server starts up. There is only one ClusterManager per Naming Server. The role of a ClusterManager is to create, retrieve, and keep track of the clusters that are in the Naming Server. Here are the general steps in creating an object cluster:

- 1 Bind to the Naming Server with which you wish to create cluster objects.
- 2 Get a reference to the Cluster Manager by calling get\_cluster\_manager method on the factory reference.
- 3 Create a cluster using a specified cluster criterion.
- 4 Bind objects to an Name using the cluster.

- 5 Bind the Cluster object itself to a Name.
- 6 Resolve through the Cluster reference for the specified cluster criterion.

```

...
ExtendedNamingContextFactory myFactory =
    ExtendedNamingContextFactoryHelper.bind(orb,
    FNamingService");
ClusterManager clusterMgr =
myFactory.get_cluster_manager();
Cluster clusterObj =
clusterMgr.create_cluster("RoundRobin");
clusterObj.bind(new NameComponent("member1", "aCluster"),
obj1);
clusterObj.bind(new NameComponent("member2", "aCluster"),
obj2);
clusterObj.bind(new NameComponent("member3", "aCluster"),
obj3);
NameComponent myClusterName = new
NameComponent("ClusterName", "");
root.bind(myClusterName, clusterObj);
root.resolve(myClusterName) // a member of the Cluster is
returned.
root.resolve(myClusterName) // the next member of the
Cluster is returned.
root.resolve(myClusterName) // the last member of the
Cluster is returned.
...

```

### Explicit and implicit object clusters

The clustering feature can be turned on automatically for a VisiNaming Service. The caveat is that once this facility is on, a cluster is created transparently to bind the object. The round robin criterion is used. The implication is that it is possible to bind several objects to the same name in the Naming Server. Conversely, resolving that name will return one of those objects, and an `unbind` operation would destroy the cluster associated with that name. This means that the VisiNaming Service is no longer compliant to the CORBA specification. The *Interoperable Naming Specification* explicitly forbids the ability to bind several objects to the same name. For a compliant VisiNaming Service, an `AlreadyBound` exception is thrown if a client tries to use the same name to bind to a different object. You must decide whether to use this feature for a dedicated server only.

#### Note

Do not switch from an implicit cluster mode to an explicit cluster mode as this can corrupt the backing store.

Once a Naming Server is used with the implicit clustering feature, it must be activated with that feature turned "on". To turn on the clustering feature, define the following property value in the configuration file:

```
vbroker.naming.propBindOn=1
```

For an example of both explicit and implicit clustering, see the code located in the following directories:

```

<install_dir>/examples/vbroker/ins/implicit_clustering
<install_dir>/examples/vbroker/ins/explicit_clustering

```



## Load balancing

Both the ClusterManager and the Smart Agent provide RoundRobin criterion load balancing facilities, however, they are of very different nature. You get load balancing from the Smart Agent transparently. When a server starts, it registers itself automatically with the Smart Agent, and this in turn allows VisiBroker ORB to provide an easy and proprietary way for the client to get a reference to the server. However, you have no choice in determining what constitutes a group and the members of a group. The Smart Agent makes all the decisions for you. This is where a Cluster provides an alternative. It enables a programmatic way to define and create the properties of a Cluster. You can define the criterion for a Cluster, including choosing the members of a Cluster. Though the criterion is fixed at creation time, the client can add or remove members from the Cluster throughout its existence.

## Object failover

An advantage of using object clustering is the failover capability among the objects clustered together in a VisiNaming service. These clustered objects support the same interface. Once such a cluster is created and bound to a naming context, the failover behavior is transparently handled by the ORB. Typically when a naming service client does a resolution against this cluster, the VisiNaming service returns a member from the cluster. In case any member of the cluster has crashed or is temporarily unavailable, ORB and VisiNaming service perform transparent failover by handing over the next available cluster member to the client. This ensures high availability and fault-tolerance.

Failover capability using object clustering is demonstrated in the example contained in the following directory:

```
<install_dir>/examples/vbroker/ins/cluster_failover
```

## Pruning stale object references in VisiNaming object clusters

Object references in VisiNaming service can become stale due to unavailability of the servers. Implicit object clustering provides different strategies, which can be used to configure the pruning of stale references. Note that this pruning facility only works in implicit clustering using smart round-robin technique. VisiNaming service is started with a pruning configuration using the property `vbroker.naming.smrr.pruneStaleRef`. This property can take values 0, 1 (default) and 2. The working of pruning facility can be understood as follows.

VisiNaming service holds the mapping between the names and object references in the memory. When a client requests for an object reference against a name, VisiNaming resolves the name, modifies the IOR and hands over the object reference to the client. The modification pertains to putting the logic that in case, the server represented by the object reference is unavailable, the client ORB, to which this object reference is being handed to, can revert back to the VisiNaming service to look for an alternate object reference (fail-over to another candidate). If the client is unable to find the server and it does revert back to the VisiNaming service, VisiNaming marks that object reference as stale.

Depending on the value of the property `vbroker.naming.smrr.pruneStaleRef`, VisiNaming decides whether to keep the object reference or remove it. Following are the possible values:

- `vbroker.naming.smrr.pruneStaleRef =0`  
In this case, if an object reference has been detected stale, VisiNaming only marks it as stale but does not remove it from its in-memory hold. However, VisiNaming does not ever hand over this reference to the client unless the server rebinds the object reference against the same name.
- `vbroker.naming.smrr.pruneStaleRef =1`  
VisiNaming service immediately removes the object reference both from the memory and persistent backstore (if backing store is being used) as soon as the client bounces back to the VisiNaming service indicating the object reference as stale.
- `vbroker.naming.smrr.pruneStaleRef =2`  
In this case, VisiNaming does not modify the IOR before handing it over to the client. In case the client is not able to contact the server represented by the object reference, client ORB throws `OBJECT_NOT_EXIST` exception back to the client application. VisiNaming services does not take guarantee of providing the client application with an active object reference.

## VisiNaming Service Clusters for Failover and Load Balancing

Multiple instances of the VisiNaming Service can be clustered to provide for load balancing and failover. These clusters of VisiNaming Service instances should not be confused with the clustering of object bindings described in [“Object Clusters”](#). Clients can bind to any one of the VisiNaming Service instances that comprise the cluster, which allows for load sharing across multiple VisiNaming Service instances. If a particular VisiNaming Service instance becomes inactive or terminates, the client will automatically fail over to another VisiNaming Service instance within the same cluster.

All instances of the VisiNaming Service within a cluster must use the common underlying data in a persistent backing store. The caching facility is available to Naming Service instances provided that a VisiBroker Event Service (or VisiNotify) instance is made available to the Naming Service instances via the `vbroker.naming.cache.connectString` property. There are certain restrictions regarding the choice of backing store. See the following Note that discusses these restrictions.

When failover occurs, it is transparent to the client, but there can be a slight delay because server objects might have to be activated on demand by the requests that are coming in. Also, object reference transients like iterator references are no longer valid. This is normal because clients using transient iterator references must be prepared for those references becoming invalid. In general, a VisiNaming Service instance never keeps too many resource-intensive iterator objects, and it may invalidate a client's iterator reference at any time. Other than these transient references, any other client request using persistent references will be rerouted to another VisiNaming Service instance.

In addition to the VisiNaming Service cluster, a Master/Slave model is also supported. This is a special cluster with the configuration of two VisiNaming Service instances. It is useful only when failover is required. The two VisiNaming Services instances must be running at the same time; the master in active mode and the slave in standby mode. If both VisiNaming Services are active, the master is always preferred by clients that are using

VisiNaming Service. In the event that the master terminates unexpectedly, the slave VisiNaming Service takes over. This changeover from master to slave is seamless and transparent to clients. However, the slave VisiNaming Service does not become the master server. Instead, it provides temporary backup when the master server is unavailable. You must take whatever remedial actions necessary to revive the master server. After the master comes back up again, only requests from the new clients are sent to the master server. Clients that are already bound to a slave naming server will not automatically switch back to the master.

### Notes

- Clients that are bound to a slave naming server provide only one level of failover support. They will not switch back to the master, therefore, if the slave naming server terminates, the VisiNaming Service also becomes unavailable.
- VisiNaming Service Clusters configured in the Master/Slave mode may use either the JNDI adapter or the JDBC adapter. Clusters not configured in the Master/Slave mode must use the JDBC adapter for RDBMS. Each clustered service must obviously point to the same backing store. See [“Pluggable backing store”](#) for information on configuring the backing store for the cluster.

## Configuring the VisiNaming Service Cluster

The VisiNaming Service instances that comprise the cluster must be started with the relevant properties set as illustrated in the code sample below. The configuration is set to cluster mode using the `enableSlave` and the `slaveMode` properties. The instances of the VisiNaming Service that comprise the cluster have to be started on the hosts and ports specified using the `serverAddresses` property. The snippet shows the host and port entries for the three VisiNaming Service instances in the sample cluster. The `serverNames` property lists the factory names of the VisiNaming Service instances. These names are unique and the ordering identical to the `serverAddresses` property. Finally, the `serverClusterName` property names the cluster.

### Note

Starting from VisiBroker 6.0, VisiNaming Service contains several properties for proxy support:

- `vbroker.naming.proxyEnable` allows the VisiNaming Service to use a proxy. Turn off this property (default is turned off), and the VisiNaming Service will ignore other Naming service properties for the proxy.
- `vbroker.naming.proxyAddresses` gives each Naming service in the cluster a proxy host and a proxy port. The ordering of the `proxyAddresses` is identical to the `serverAddresses`.

Java clients need to use the system property `-Dvbroker.naming.anyServiceOrder=true` in order to benefit from the load balancing and failover capabilities provided by VisiNaming Service clusters. Clients can use the system property `-DsvCnameroot=<serverClusterName>` to resolve to a VisiNaming Service instance within the cluster, provided `osagent` is being used. Alternately, the `corbaloc` mechanism can be used (by specifying the host and port pairs for all the VisiNaming Service instances that comprise the cluster, for use by `resolve_initial_references`).

The Naming Service instances comprising a Cluster can benefit from the Naming Service Caching Facility. Use the `vbroker.naming.cacheOn` and `vbroker.naming.cache.connectString` properties to configure caching for a Naming Service cluster. See [“Caching facility”](#) for details.

The following code sample shows the configuration of the VisiNaming Service cluster:

```
vbroker.naming.enableSlave=1
vbroker.naming.slaveMode=cluster
vbroker.naming.serverAddresses=host1:port1;host2:port2;hos
t3:port3
vbroker.naming.serverNames=Server1:Server2:Server3
vbroker.naming.serverClusterName=ClusterX
vbroker.naming.proxyEnable=1 //Any value other than 1
means proxy is not enabled.
vbroker.naming.proxyAddresses=proxyHost1:proxyPort1;proxyH
ost2:proxyPort2;proxyHost3:proxyPort3
```

### Note

When using the `vbroker.naming.proxyAddresses` property, place a semicolon (;) separator between each host and port pair.

## Configuring the VisiNaming Service in Master/Slave mode

The two VisiNaming Services must be running. You must designate one as the master and the other as the slave. The same property file can be used for both the servers. The relevant property values in the property file are shown in the following code sample to configure for the Master/Slave mode.

```
vbroker.naming.enableSlave=1
vbroker.naming.slaveMode=slave
vbroker.naming.masterServer=<Master Naming Server Name>
vbroker.naming.masterHost=<host ip address for Master>
vbroker.naming.masterPort=<port number that Master is listening on>
vbroker.naming.slaveServer=<Slave Naming Server Name>
vbroker.naming.slaveHost=<host ip address for Slave>
vbroker.naming.slavePort=<Slave Naming Server port address>
vbroker.naming.proxyEnable=1
vbroker.naming.masterProxyHost=<proxy host ip address for Master>
vbroker.naming.masterProxyPort=<proxy port number for Master>
vbroker.naming.slaveProxyHost=<proxy host ip address for Slave>
vbroker.naming.slaveProxyPort=<proxy port number for slave>
```

### Note

There is no restriction in the start sequence of the master and the slave servers.

## Starting up with a large number of connecting clients

In a production environment with a large number of clients it may be impossible to avoid clients trying to connect to a Naming Service which is still in the startup phase (still initializing and not yet ready to service requests). When a Naming Service is not yet completely started up it may receive incoming requests and discard them. Depending on the number of

requests, which must be received then discarded, this activity can use too many CPU resources which can disturb the startup process itself, resulting in a long startup time for the Naming Service.

To solve this particular problem, and let the Naming Service start quickly, the following configuration settings can be used:

- 1 Set the following property to `true`:

```
vbroker.se.iioptp.scm.iioptp.listener.deferAccept=true
```

- 2 Use a fixed listener port by setting the following properties:

```
vbroker.se.iioptp.scm.iioptp.scm.listener.port=<port_number>
vbroker.se.iioptp.scm.iioptp.listener.portRange=0
```

For this to succeed, make sure that the `<port_number>` is available on the host on which the Naming Service is running. Make sure that the `portRange` property is set to 0 (zero). You can leave it at its default setting or explicitly set the property. Note that both the `port` and `portRange` settings described above should be applied.

Clients that try to connect to a Naming Service configured in this manner while it is starting up will be denied any connection. If they are accessing a Naming Service Cluster, then they would fail over to another Naming Service that has finished its initialization. If no Naming Services are up and running, the client application would get an `OBJECT_NOT_EXIST` exception.

These settings are per SCM (Server Connection Manager). If needed, all SCMs can be set to take advantage of this feature.

If SSL is involved in the Naming Service, in addition to the settings described above, the following settings might also be needed:

```
vbroker.se.iioptp.scm.ssl.listener.deferAccept=true
vbroker.se.iioptp.scm.ssl.listener.port=<port_number_for_ssl>
vbroker.se.iioptp.scm.ssl.listener.portRange=0
```

### Note

The `deferAccept` property should only be used for Naming Services. Using for other services or user written servers can result in undefined behavior.

## VisiNaming service federation

Federation enables more than one VisiNaming services to be configured to act as a distributed namespace. This involves having a naming context in a name service bound to the names in the naming contexts of other naming services, thereby providing more than one naming hierarchy to access an object. The figure below shows two instances of naming service `ns1` and `ns2`. Grayed naming contexts are the initial contexts of the respective naming services. An `AccountManager` object `s1` is placed in a naming context under `ns1`.

**Figure 26** Naming contexts with multiple access hierarchies

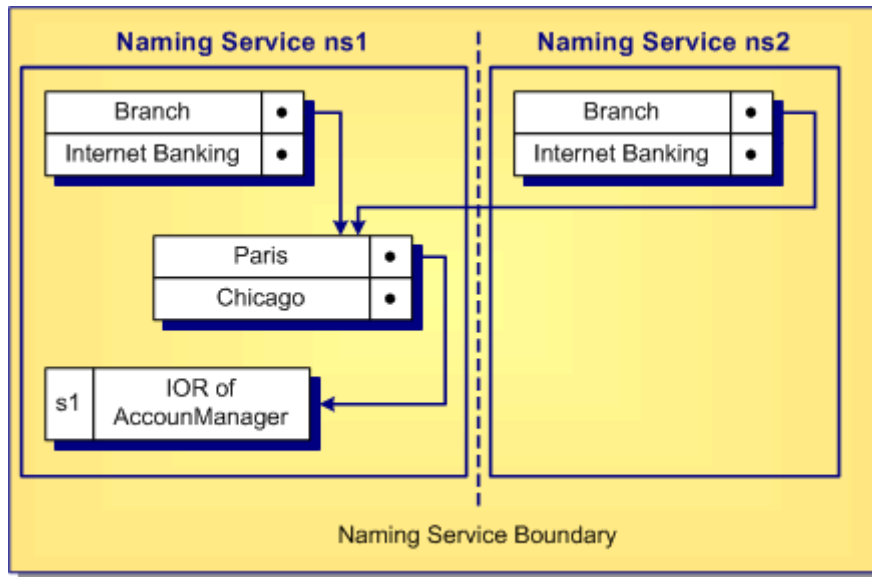

As shown in the figure, the naming context containing `Paris` is bound to `Branch` under naming service `ns1` and also bound to `Branch` under naming service `ns2`. Client can retrieve the IOR of the `AccountManager` object against `s1` either by resolving `ns1: Branch/Paris/s1` or `ns2: Branch/Paris/s1`. In both cases, it gets the same IOR.

Setting up federation is as easy as binding the name `Branch` in the root context of `ns2` in the above example to the naming context containing the name `Paris` in `ns1`. The example in the following location shows the working of VisiNaming federation:

```
<install_dir>/examples/vbroker/ins/federation
```

## VisiNaming Service Security

The VisiNaming Service in the VisiBroker integrates with the Security Service, providing two levels of security: Client authentication and Method level authorization. This allows fine grained control over which clients can use the VisiNaming Service and what methods they can call. The following properties are used to enable or disable security and to configure the Security Service.

Property	Value	Default	Description
<code>vbroker.naming.security.disable</code>	boolean	true	This property indicates whether the security service is disabled.
<code>vbroker.naming.security.authDomain</code>	string	""	This property indicates the authorization domain name to be used for the Naming service method access authorization.
<code>vbroker.naming.security.transport</code>	int	3	This property indicates what transport to be used. The available values are:  <code>ServerQoPPolicy.SECURE_ONLY=1</code> <code>ServerQoPPolicy.CLEAR_ONLY=0</code> <code>ServerQoPPolicy.ALL=3</code>

Property	Value	Default	Description
<code>vbroker.naming.security.requireAuthentication</code>	boolean	false	This property indicates whether naming client authentication is required. When <code>vbroker.naming.security.disable</code> is true, no client authentication will be performed regardless what value this property takes.
<code>vbroker.naming.security.enableAuthorization</code>	boolean	false	This property indicates whether method access authorization is enabled.
<code>vbroker.naming.security.requiredRolesFile</code>	string	(none)	This property points to the file containing the required roles that are necessary for invocation of each method in the protected object types. For more information see <a href="#">“Method Level Authorization”</a> .

## Naming client authentication

### Note

For detailed information on authentication and authorization, see the Authentication and Authorization chapters in the *VisiBroker Security Guide*.

## Configuring VisiNaming to use SSL

Depending on the security requirements, different properties can be set to configure the VisiNaming service. For the full list of security properties and their descriptions, go to the *VisiBroker Security Guide*, in the *Security Properties for Java* or the *Security Properties for C++* section.

### Important

In order to enable security in the VisiNaming Service, you must have a valid VisiSecure license.

The following is a sample of the properties that can be used to configure the VisiNaming Service to use SSL:

```
# Enable Security in Naming Service
vbroker.naming.security.disable=false

# Enabling Security Service
vbroker.security.disable=false

# Setting SSL Layer Attributes

vbroker.security.peerAuthenticationMode=REQUIRE_AND_TRUST
vbroker.se.iiop_tp.scm.ssl.listener.trustInClient=true
vbroker.security.trustpointsRepository=Directory:./trustpoints

# Set the certificate identity for the VisiNaming
Service using wallet properties
vbroker.security.wallet.type=Directory:./identities
vbroker.security.wallet.identity=delta
vbroker.security.wallet.password=Delt@$$$
```

For information about how to configure the client to use SSL, go to the **VisiBroker Security Guide**, *Making secure connections (Java)* or the *Making secure connections (C++)* sections.

### Note

Currently, there is no way to specify security and secure transport components in an IOR using corbaloc. So, when using SSL, bootstrapping a VisiNaming Service using the corbaloc method at the Naming client side is not possible. However, the SVCnameroot and stringified IOR methods can still be used.

## Method Level Authorization

Method level authorization is supported for the following object types:

- Context
- ContextFactory
- Cluster
- ClusterManager

When security is enabled for the Naming service and `enableAuthorization` is set to `true`, only authorized users of each method of these object types can invoke the corresponding method.

The Naming service predefines two roles to support the method level authorization:

- Administrator role
- User role

Other roles can be defined if required. Users need to configure the roles map for these two roles, assigning roles to clients. The following is an example role map definition:

```
Administrator {
  *CN=admin
  *group=admin
  uid=*, group=admin
}

User {
  *CN=admin
  *group=user
  uid=*, group=user
}
```

You need to specify the roles before invoking each method of the objects listed above. This is done using the `required_roles` property for each method. Below is the list of these properties and the corresponding default values. These default values are used only when you do not define any `required_roles` specified using the property `vbroker.naming.security.requiredRolesFile`. The values of these properties are space or comma separated:

```
#
# naming_required_roles.properties
#

# all roles
required_roles.all=Administrator User
```



```

required_roles.Context.bind=Administrator
required_roles.Context.rebind=Administrator
required_roles.Context.bind_context=Administrator
required_roles.Context.rebind_context=Administrator
required_roles.Context.resolve=Administrator User
required_roles.Context.unbind=Administrator
required_roles.Context.new_context=Administrator User
required_roles.Context.bind_new_context=Administrator
User
required_roles.Context.list=Administrator User
required_roles.Context.destroy=Administrator

required_roles.ContextFactory.root_context=Administrator
User

required_roles.ContextFactory.create_context=Administrator

required_roles.ContextFactory.get_cluster_manager=Administ
rator User

required_roles.ContextFactory.remove_stale_contexts=Admini
strator

required_roles.ContextFactory.list_all_roots=Administrator
required_roles.ContextFactory.shutdown=Administrator

required_roles.Cluster.select=Administrator User
required_roles.Cluster.bind=Administrator
required_roles.Cluster.rebind=Administrator
required_roles.Cluster.resolve=Administrator User
required_roles.Cluster.unbind=Administrator
required_roles.Cluster.destroy=Administrator
required_roles.Cluster.list=Administrator User

required_roles.ClusterManager.create_cluster=Administrator
required_roles.ClusterManager.find_cluster=Administrator
User

required_roles.ClusterManager.find_cluster_str=Administ
rator User
required_roles.ClusterManager.clusters=Administrator
User

```

## Import statements

The following import statement must be used by any Java class that wishes to use the VisiBroker ORB extensions to the VisiNaming Service:

```

import com.inprise.vbroker.CosNamingExt.*;
...

```

The following packages are needed if you are interested in accessing the OMG compliant features of the VisiNaming Service:

```

import org.omg.CosNaming.*
Import org.omg.CosNaming.NamingContextPackage.*
Import org.omg.CosNaming.NamingContextExtPackage.*

```

## Sample programs

Several example programs that illustrate the use of the VisiNaming Service are provided with VisiBroker. They show all of the new features available with the VisiNaming Service and are found in the `<install_dir>/examples/vbroker/ins` directory. In addition, a Bank Naming example illustrates basic usage of the VisiNaming Service is found in the `<install_dir>/examples/vbroker/basic/bank_naming` directory.

Before running the example programs, you must first start the VisiNaming Service, as described in ["Running the VisiNaming Service"](#). Furthermore, you must ensure that at least one naming context has been created by doing one of the following:

- Start the VisiNaming Service, as described in ["Running the VisiNaming Service"](#), which will automatically create an initial context.
- Use the VisiBroker Console.
- Have your client bind to the `NamingContextFactory` and use the `create_context` method.
- Have your client use the `ExtendedNamingContextFactory`.

### Important

If no naming context has been created, a `CORBA.NO_IMPLEMENT` exception is raised when the client attempts to issue a `bind`.

## Binding a name example

The Bank Naming example uses the `AccountManager` interface to open an `Account` and to query the balance in that account. The `Server` class below illustrates the usage of the VisiNaming Service for binding a name to an object reference. The server publishes its IOR into the root context of the Naming Server, which is then retrieved by the client.

From this example, you learn how to:

- 1 Use the `resolve_initial_references` method on the VisiBroker ORB instance to get a reference to the root context of the VisiNaming Service. (In the example, you need to start the VisiNaming Service with the default name of `NameService`.)
- 2 Cast the reference for the root context by using the `narrow` method of the `NamingContextExtHelper` class.
- 3 Create a POA and servant for your `AccountManagerImpl` object.
- 4 Finally use the `bind` method of the `NamingContext` interface to bind the `Name BankManager` to the object reference for the `AccountManagerImpl` object.

For more information about POAs, see [“Using POAs”](#).

```

import org.omg.PortableServer.*;
import org.omg.CosNaming.*;
public class Server {
    public static void main(String[] args) {
        try {
            // Initialize the ORB.
            org.omg.CORBA.ORB orb =
org.omg.CORBA.ORB.init(args,null);

            // get a reference to the root POA
            POA rootPoa =

POAHelper.narrow(orb.resolve_initial_references("RootPOA")
);

            // get a reference to the VisiNaming Service root
context
            org.omg.CORBA.Object rootObj =
                orb.resolve_initial_references("NameService");
            NamingContextExt root =
NamingContextExtHelper.narrow(rootObj);

            // Create policies for our persistent POA
            org.omg.CORBA.Policy[] policies = {

rootPoa.create_lifespan_policy(LifespanPolicyValue.PERSIST
ENT)
        };

            // Create myPOA with the right policies
            POA myPOA = rootPoa.create_POA( "bank_agent_poa",
            rootPoa.the_POAManager(), policies );

            // Create the servant
            AccountManagerImpl managerServant = new
AccountManagerImpl();

            // Decide on the ID for the servant
            byte[] managerId = "BankManager".getBytes();

            // Activate the servant with the ID on myPOA
            myPOA.activate_object_with_id(managerId,
managerServant);

            // Activate the POA manager
            rootPoa.the_POAManager().activate();

            // Associate the bank manager with the name at
the root context
            // Note that casting is needed as a workaround
for a JDK 1.1.x bug.

            ((NamingContext)root).bind(root.to_name("BankManager"),
                myPOA.servant_to_reference(managerServant));

System.out.println(myPOA.servant_to_reference(managerServant)
+ " is ready.");

```

```

        // Wait for incoming requests
        orb.run();
    } catch (Exception e) {
        e.printStackTrace();
    }
}
}

```

## Configuring VisiNaming with JDataStore HA

This section helps you configure JDataStore High Availability (HA) to work with VisiNaming.

The Explicit Clustering example used throughout this section illustrates the usage of JDataStore HA with VisiNaming. In this example, JDataStore will be configured to have the following mirror types:

- One Primary mirror. This is the only mirror type that can accept both read and write transactions. Only one Primary mirror at a time is allowed.
- Three Read-only mirrors. These can only perform read transactions. They provide a transactionally consistent view of the Primary mirror database.
- One Directory mirror. This contains only the mirror configuration table and other system security tables. It redirects read-only connection requests to Read-only mirrors, and writable connection requests to the Primary mirror. It also provides an important feature for load balancing all read connections across all available Read-only mirrors. However, this feature is not supported by Naming Service in this version.

JDataStore HA supports automatic failover in the following circumstances:

- If a connection to the Primary mirror was made before the failure, this connection can trigger an automatic failover by calling the rollback method on the connection object. Note that this scenario is not described in this section.
- If the connection request is not for read-only operation, and the current Primary mirror is not accessible, the Directory mirror automatically triggers the failover operations to satisfy the request for a writable connection. This is done by promoting one of the Read-only mirrors to the Primary mirror.

VisiNaming works with JDataStore HA when a connection is made to the Directory mirror. When the Primary mirror is inaccessible, it will failover to one of the Read-only mirrors. VisiNaming must work with one Primary, and at least two Read-only mirrors at all times.

### Notes

- The Directory Mirror is a single point of failure in the scenario described in this section. Higher availability could be achieved by configuring Master and Slave Naming Services to point to a different directory mirror.
- JDataStoreHA only works with JDataStore Version 7.04 or later.

## Create a DB for the Primary mirror

To make use of the JDataStore Explorer (JdsExplorer) to create a new DB, select New from the File menu.

## Invoke JdsServer for each listening connection

In this example, the following connections are used:

- JdsServer –port 2511 (Primary mirror)
- JdsServer –port 2512 (Read-only mirror)
- JdsServer –port 2513 (Read-only mirror)
- JdsServer –port 2514 (Read-only mirror)
- JdsServer –port 2515 (Directory mirror)

### Note

Always start JdsServer from the location where the `AutoFailover_* jds` files are located. Never start JdsServer from `<JdataStore Install Directory>/bin` unless `vbroker.naming.url` is set according. The required jar files are:

- dbtools.jar
- dbswing.jar
- jdsremote.jar
- jdsserver.jar
- jds.jar

## Configure JDataStore HA

To configure JDataStore HA, complete the following steps:

- 1 Invoke the JDS Server Console to configure JDataStore.
- 2 Create a new project named `NS_AutoFailover` in the JDataStore Server Console.

### Note

When creating a new `DataSource`, it is best to set its Protocol to Remote and include the machine IP in the `ServerName`

- 3 Click `DataSource1` (in the Structure pane) to open it for editing.
- 4 Right-click `DataSource1` and select `Connect` from the context menu.
- 5 Right-click `Mirror` (in the Structure pane) and select `Add mirror` from the context menu.
- 6 Edit `Mirror1` so that the `Type` property is set to `PRIMARY`.  
Each of the mirrors should also ensure that the host uses the IP of the machine where they are located instead the default value of `localhost`. You can use a different IP address for each of the mirrors, as long as the `JdsServer` is started for that mirror at the IP. The `Directory` mirror must have access to each of the mirrors.
- 7 Set the `Auto Failover` and `Instant Synchronization` properties to `true`.
- 8 Add `Mirror2` and edit it to be a `Read-only` mirror.  
Note that you do not need to create `AutoFailover_Mirror2` beforehand. It is created automatically by JDataStore HA.
- 9 Set the `Auto Failover` and `Instant Synchronization` properties to `true` for all `Read-only` mirrors.

- 10 Repeat the previous two steps for Mirror3 and Mirror4.
- 11 Add Mirror5 and edit it to be the Directory mirror.
- 12 Set the Auto Failover and Instant Synchronization properties to false for this Directory mirror.
- 13 Choose Save Project "NS\_AutoFailover.datasources" from the File menu to save the project.
- 14 Right-click Mirrors (in the Structure pane) and choose Synchronize all mirrors.
- 15 Click Mirror Status (in the Structure pane) and verify that Validate Primary is checked for Mirror1 only.

## Run the VisiNaming Explicit Clustering example

To run the VisiNaming Explicit Clustering example, complete the following steps:

- 1 Start osagent with the following command:

```
osagent
```

- 2 Create a file named autofailover.properties with the following properties:

```
vbroker.naming.backingStoreType=JDBC
vbroker.naming.poolSize=5
vbroker.naming.jdbcDriver=com.borland.datastore.jdbc.DataStoreDriver
vbroker.naming.url=jdbc:borland:dsremote://
143.186.141.14/AutoFailover_Mirror5.jds
vbroker.naming.loginName=SYSDBA
vbroker.naming.loginPwd=masterkey
vbroker.naming.traceOn=0
vbroker.naming.jdsSvrPort=2515
vbroker.log.enable=true
vbroker.log.logLevel=debug
```

- 3 Start Naming Service with the following command:

```
nameserv -VBJclasspath <JDS_Install>\lib\
jdsserver.jar -config autofailover.properties
```

- 4 Start ServerA with the following command:

```
vbj -DSVCnameroot=NameService ServerA
```

- 5 Start ServerB with the following command:

```
vbj -DSVCnameroot=NameService ServerB
```

- 6 Start Client with the following command:

```
vbj -DSVCnameroot=NameService Client NameService
```

- 7 Repeat the previous step several times and observe the output.

To verify the minimum requirement of one Primary and two Read-only mirrors, complete the following steps:

- 1 Stop the JdsServer listening to port 2513.
- 2 Repeat the Start Client step several times.

Note that the behavior is the same as in the previous procedure.

- 3 Stop the JdsServer listening to port 2514.

- 4 Repeat the Start Client step several times.

Note that Client begins to raise a `BAD_PARAM` exception. This is as expected because a failover requires that at least two read-only mirrors are available.

- 5 Restart the JdsServer listening to port 2513 and 2514.

This restores the original configuration, with three Read-only mirrors.

To verify the autofailover of JDataStore HA, complete the following steps:

- 1 Stop the JdsServer listening to port 2511, configured for Primary mirror, and repeat the Start Client step several times.

Note that one of the Read-only mirrors has been promoted to Primary mirror.

- 2 Stop another active Read-only mirror and repeat the Start Client step several times.

Note that Client begins to raise a `BAD_PARAM` exception because a failover requires that at least two read-only mirrors are available.

- 3 Restart the JdsServer listening to port 2511.

Note that this was previously configured for Primary mirror.

- 4 Repeat the Start Client step several times.

Note that Mirror1 is now configured as Read-only mirror. You can check this from the JDS Server Console by making a datasource connection to the Directory mirror that the Naming Service uses.

## Run the VisiNaming Naming Failover example

Run the following example to observe the failover capability of the VisiNaming service.

### Note

Before using this procedure, create a JDataStore HA with one Primary mirror at port 1111, three Read-only mirrors at ports 1112, 1113, 1114 and two Directory mirrors at ports 1115 and 1116.

- 1 Start osagent with the following command:

```
osagent
```

- 2 Create a file named `autofailover.properties` with the following properties:

```
# Naming
vbroker.naming.backingStoreType=JDBC
vbroker.naming.poolSize=5
vbroker.naming.jdbcDriver=com.borland.datastore.jdbc.DataStoreDriver
vbroker.naming.loginName=SYSDBA
vbroker.naming.loginPwd=masterkey
vbroker.naming.traceOn=0
vbroker.naming.jdsSvrPort=1115
vbroker.log.enable=true
vbroker.log.logLevel=debug
#default value of enableslave is 0. '1' Indicates
cluster or master-slave configuration
vbroker.naming.enableSlave=1
#indicate master-slave configuration
vbroker.naming.slaveMode=slave
```

```
vbroker.naming.masterHost=143.186.141.14
vbroker.naming.masterPort=12372
vbroker.naming.masterServer=Master
vbroker.naming.slaveHost=143.186.141.14
vbroker.naming.slavePort=12373
vbroker.naming.slaveServer=Slave
```

- 3 Start the JDataStore Servers as shown in the following example:

```
JdsServer.exe -port=1111
JdsServer.exe -port=1112
JdsServer.exe -port=1113
JdsServer.exe -port=1114
JdsServer.exe -port=1115
JdsServer.exe -port=1116
```

- 4 Start the Naming Service Master with the following command:

```
nameserv -VBJclasspath <JDS_Install>\lib\
jdsserver.jar -config autofailover.properties -VBJprop
vbroker.naming.url=jdbc:borland:dsremote://
143.186.141.14/AutoFailover_Mirror5.jds
-VBJprop
vbroker.se.iiop_tp.scm.iiop_tp.listener.port=12372
Master
```

- Start the Naming Service Slave with the following command:

```
nameserv -VBJclasspath <JDS_Install>\lib\
jdsserver.jar -config autofailover.properties -VBJprop
vbroker.naming.url=jdbc:borland:dsremote://
143.186.141.14/AutoFailover_Mirror6.jds
-VBJprop
vbroker.se.iiop_tp.scm.iiop_tp.listener.port=12373 -
VBJprop vbroker.naming.jdsSvrPort=1116
Slave
```

- 1 Start Server with the following command:

```
vbj -DSVCnameroot=Master Server
```

- 2 Start Client with the following command:

```
vbj -DSVCnameroot=Master Client
```

- 3 Press the *Enter* key and observe the output.

Note that the balance returns a value.

- 4 Stop the Naming Service Master, repeat the previous step, and observe the output.

Note that the balance returns a value.

- 5 Press the *Enter* key to exit, and observe the output.

Note that the balance returns a value.

To see how two Directory mirrors handle a single point of failure, complete the following steps:

- 1 Stop the JdsServer listening to port 1115.
- 2 Without starting the Naming Service Master, repeat the Start Client step. The CannotProceed exception is raised, which is the expected behavior.
- 3 Repeat the Start Client step several times.



Note that the balance will return a value. Once it can return a value, you can observe that it is using the Directory mirror that is listening on port 1117.

- 4 Repeat the Start Client step and press the *Enter* key three times.

Note that the balance returns a value for three times.

To see how autofailover functions with two Directory mirrors, complete the following steps:

- 1 Stop the JdsServer that is listening on port 1111.
- 2 Repeat the Start Client step.
- 3 Press the *Enter* key three times.

The `CannotProceed` exception is raised several times before it starts returning a value. Once it returns a value, you can see that one of the mirrors is promoted to be a Primary mirror. This can only be viewed using the JDS Server Console.



# Using the Event Service

This section describes the VisiBroker Event Service.

## Note

The OMG Event Service has been superseded by the OMG Notification Service. The VisiBroker Event Service is still supported for backward compatibility and light weight purposes. For mission critical applications, we strongly recommend using VisiBroker VisiNotify. For more information, see the *VisiBroker VisiNotify Guide*.

## Overview

The Event Service package provides a facility that de-couples the communication between objects. It provides a *supplier-consumer* communication model that allows multiple *supplier objects* to send data asynchronously to multiple *consumer objects* through an event channel. The supplier-consumer communication model allows an object to communicate an important change in state, such as a disk running out of free space, to any other objects that might be interested in such an event.

**Figure 27** Supplier-Consumer communication model

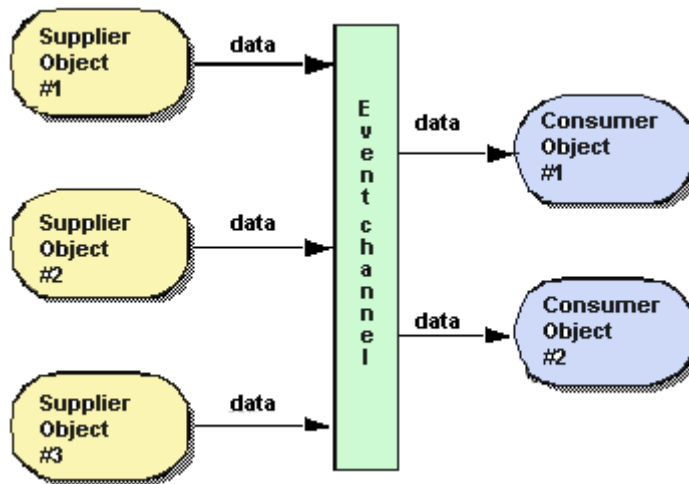

The figure above shows three supplier objects communicating through an event channel with two consumer objects. The flow of data into the event channel is handled by the supplier objects, while the flow of data out of the event channel is handled by the consumer objects. If each of the three suppliers shown in the figure above sends one message every second, then each consumer will receive three messages every second and the event channel will forward a total of six messages per second.

The event channel is both a consumer of events and a supplier of events. The data communicated between suppliers and consumers is represented by the `Any` class, allowing any CORBA type to be passed in a type safe manner. Supplier and consumer objects communicate through the event channel using standard CORBA requests.

## Proxy consumers and suppliers

Consumers and suppliers are completely de-coupled from one another through the use of *proxy objects*. Instead of interacting with each other directly, they obtain a proxy object from the `EventChannel` and communicate with it. Supplier objects obtain a *consumer proxy* and consumer objects obtain a *supplier proxy*. The `EventChannel` facilitates the data transfer between consumer and supplier proxy objects. The figure below shows how one supplier can distribute data to multiple consumers.

**Figure 28** Consumer and supplier proxy objects

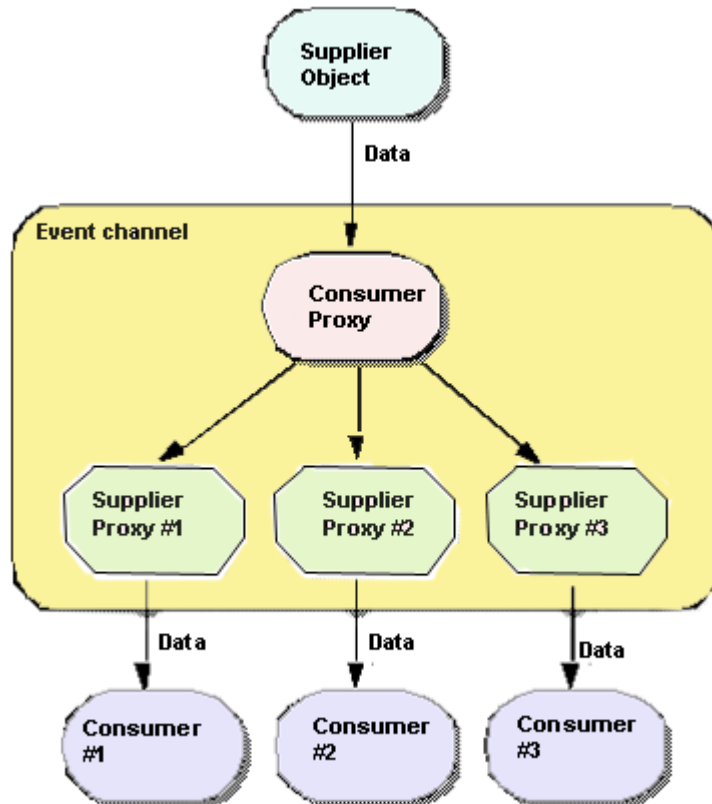

**Note**

The event channel is shown above as a separate process, but it may also be implemented as part of the supplier object's process. See [“Starting the Event Service”](#) for more information.

## OMG Common Object Services specification

The VisiBroker Event Service implementation conforms to the OMG Common Object Services Specification, with the following exceptions:

- The VisiBroker Event Service only supports generic events. There is currently no support for typed events in the VisiBroker Event Service.
- The VisiBroker Event Service offers no confirmation of the delivery of data to either the event channel or to consumer applications. TCP/IP is used to implement the communication between consumers, suppliers and the event channel and this provides reliable delivery of data to both the channel and the consumer. However, this does not guarantee that all of the data that is sent is actually processed by the receiver.

## Communication models

The Event Service provides both a *pull* and *push* communication model for suppliers and consumers. In the *push model*, supplier objects control the flow of data by *pushing* it to consumers. In the *pull model*, consumer objects control the flow of data by *pulling* data from the supplier.

The `EventChannel` insulates suppliers and consumers from having to know which model is being used by other objects on the channel. This means that a pull supplier can provide data to a push consumer and a push supplier can provide data to a pull consumer.

**Figure 29** Push model

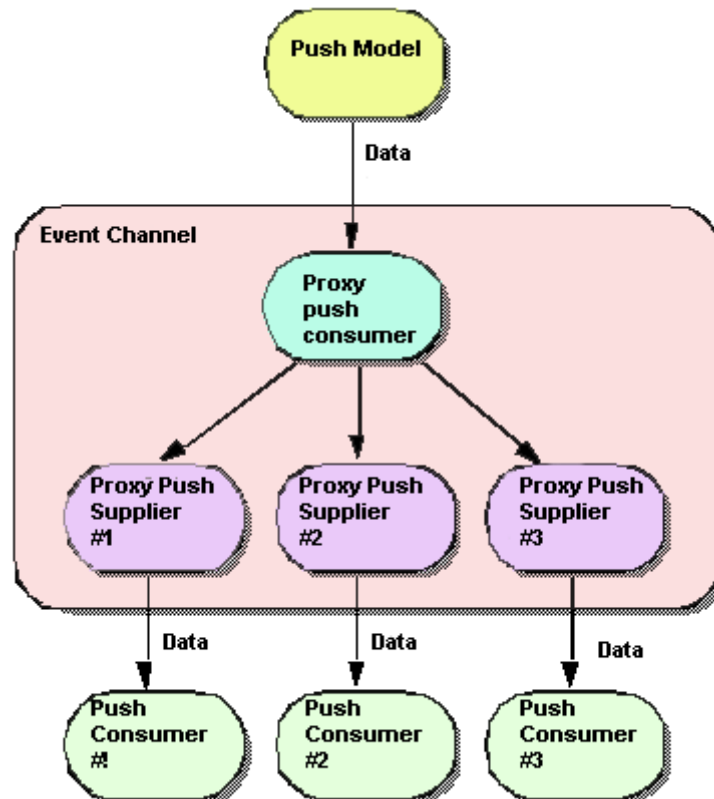

### Note

The `EventChannel` is shown above as a separate process, but it may also be implemented as part of the supplier object's process. See ["Starting the Event Service"](#) for more information.

## Push model

The *push model* is the more common of the two communication models. An example use of the push model is a supplier that monitors available free space on a disk and notifies interested consumers when the disk is filling up. The push supplier sends data to its `ProxyPushConsumer` in response to events that it is monitoring.

The push consumer spends most of its time in an event loop, waiting for data to arrive from the `ProxyPushSupplier`. The `EventChannel` facilitates the transfer of data from the `ProxyPushSupplier` to the `ProxyPushConsumer`.

The figure below shows a push supplier and its corresponding ProxyPushConsumer object. It also shows three push consumers and their respective ProxyPushSupplier objects.

## Pull model

In the *pull model*, the event channel regularly pulls data from a supplier object, puts the data in a queue, and makes it available to be *pulled* by a consumer object. An example of a pull consumer would be one or more network monitors that periodically poll a network router for statistics.

The pull supplier spends most of its time in an event loop waiting for data requests to be received from the ProxyPullConsumer. The pull consumer requests data from the ProxyPullSupplier when it is ready for more data. The EventChannel pulls data from the supplier to a queue and makes it available to the ProxyPullSupplier.

The figure below shows a pull supplier and its corresponding ProxyPullConsumer object. It also shows three pull consumers and their respective ProxyPullSupplier objects.

**Figure 30** Pull model

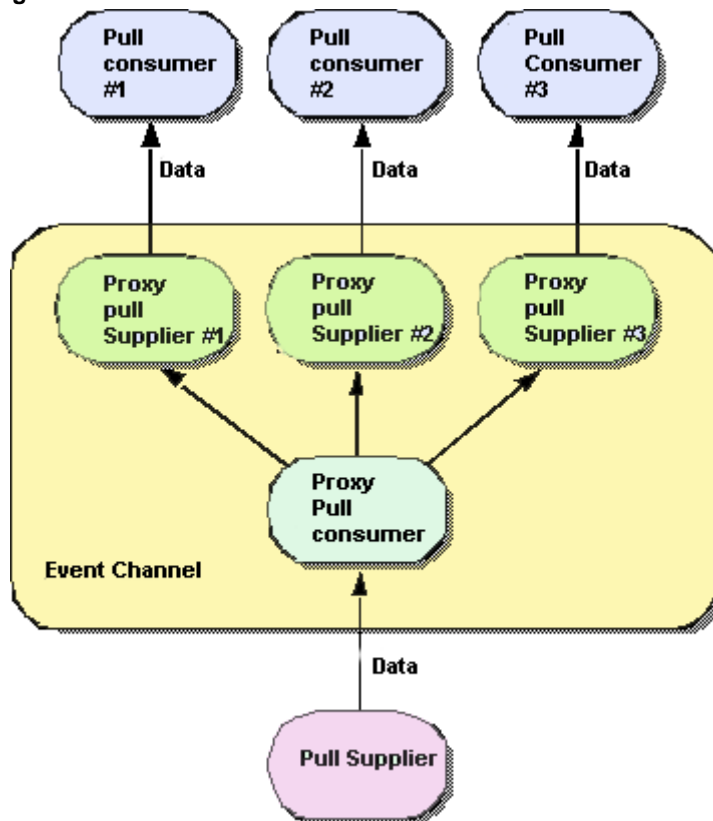

### Note

The event channel is shown above as a separate process, but it may also be implemented as part of the supplier object's process.

See ["In-process event channel"](#) for more information about how to start the event service in Java.

# Using event channels

To create an `EventChannel`, connect a supplier or consumer to it and use it:

## 1 Create and start the EventChannel:

### Windows

```
prompt> start vbj
com.inprise.vbroker.CosEvent.EventServer -ior
<iorFilename> <channelName>
```

### UNIX

```
prompt> vbj com.inprise.vbroker.CosEvent.EventServer -
ior <iorFilename> <channelName> &
```

where `<channelName>` is the user-specified object name of the event channel and `<iorFilename>` is a user-specified filename of the file to which the `ior` of the object is to be written.

Another way to create the `EventChannel` is to run `PushModelChannel`:

```
prompt> vbj PushModelChannel <iorFilename>
```

`PushModelChannel` first creates an `EventChannel` and publishes its `ior` to the file `<iorFilename>` given by the user. Other clients (for example, `PushModel`) can then bind to the `EventChannel` by using the initial reference.

To run this:

```
prompt> vbj -DORBInitRef=EventService=file:<fullpath +
iorFilename> PushModel
```

Regardless of how the event channel is created, make sure that the name specified in `<iorFilename>` is created in the specified directory.

### Note

Only one instance of the `EventChannel` is supported. All binding to the `EventChannel` is done through the call to `orb.resolve_initial_references("EventService")`, where `EventService` is the hardcoded `EventChannel` name.

- 2 Connect to the `EventChannel`.
- 3 Obtain an administrative object from the channel and use it to obtain a proxy object.
- 4 Connect to the proxy object.
- 5 Begin transferring or receiving data.

The methods used for these steps vary, depending on whether the object being connected is a supplier or a consumer, and on the communication model being used. The table below shows the appropriate methods for suppliers.

Steps	Push supplier	Pull supplier
Bind to the <code>EventChannel</code>	<code>EventChannelHelper.narrow(orb.resolve_initial_references("EventService"))</code>	<code>EventChannelHelper.narrow(orb.resolve_initial_references("EventService"))</code>
Get a <code>SupplierAdmin</code>	<code>EventChannel::for_suppliers()</code>	<code>EventChannel::for_suppliers()</code>
Get a consumer proxy	<code>SupplierAdmin::obtain_push_consumer()</code>	<code>SupplierAdmin::obtain_pull_consumer()</code>

Steps	Push supplier	Pull supplier
Add the supplier to the EventChannel	ProxyPushConsumer::connect_push_supplier()	ProxyPullConsumer::connect_pull_supplier()
Data transfer	ProxyPushConsumer::push()	Implements pull() and try_pull()

The table below shows the appropriate methods for consumers.

Steps	Push consumer	Pull consumer
Bind to the EventChannel	EventChannelHelper.narrow (orb.resolve_initial_references("EventService"))	EventChannelHelper.narrow (orb.resolve_initial_references("EventService"))
Get a ConsumerAdmin	EventChannel::for_consumers()	EventChannel::for_consumers()
Obtain a supplier proxy	ConsumerAdmin::obtain_push_supplier()	ConsumerAdmin::obtain_pull_supplier()
Add the consumer to the EventChannel	ProxyPushSupplier::connect_push_consumer()	ProxyPushSupplier::connect_pull_consumer()
Data transfer	Implements push()	ProxyPushSupplier::pull() and try_pull()

## Creating event channels

VisiBroker provides a proprietary interface called EventChannelFactory in the CosEventChannelAdmin module to allow Event Service clients to create event channels on demand. To enable this feature, start the event service for your operating system as follows:

### Windows

```
start vbj -Dvbroker.events.factory=true
com.inprise.vbroker.CosEvent.EventServer <factoryName>
```

### UNIX

```
vbj -Dvbroker.events.factory=true
com.inprise.vbroker.CosEvent.EventServer
<factoryName>
```

The property vbroker.events.factory instructs the service to create a factory object with the name <factoryName> (with a default value of VisiEvent) instead of a channel object. To write the IOR of the factory to a file, use the -ior option to provide the file name. By default, the IOR is written to the console.

The factory object created can then be bound by the client, either using the IOR written to the file (or console) or using the osagent bind mechanism to pass the factory object name. Once the factory object reference is obtained, it can be used to create, look up, or destroy event channel objects. An event channel object obtained from the factory object can be used to connect suppliers and consumers.



## Examples of push supplier and consumer

This section describes the example of the *push* supplier and the consumer applications.

### Push supplier and consumer example

This section describes the example *push* supplier and consumer applications. The files `PullSupply.java` and `PullConsume.java` implement the supplier and consumer. These files can be found in the `<install_dir>/examples/vbroker/events` directory.

To run these examples, you need a supplier-consumer pair. You can pair a consumer of type `Push` or `Pull` can be paired with any supplier of type `Push` or `Pull`. The order in which you invoke the supplier and consumer does not matter. However, the event channel must be the same object instance.

Before you can start using the Push model example, you need to run this example. The next few sections describe how to run this example.

### Running the Push model example

To run the PushModel example, enter:

```
prompt> vbj -DORBInitRef=EventService=file:<fullpath of
iorFilename> PushModel
```

Select `e` to bind to an event channel, `p` to get a proxy to a push consumer from the event channel, `m` to instantiate a `PushModel`, and `c` to connect the event channel.

Continuous sentences indicating the content of the message being pushed to the `EventChannel` will be displayed. You can continue to make selections regardless of what is displayed on the screen. You can specify the number of seconds between events using the `s` option. Lastly, select `d` to disconnect and `q` to quit.

To run the PushView, enter:

```
prompt>vbj -DORBInitRef=EventService=file:
<fullpath of iorFilename> PushView
```

Select `e` to bind to an event channel, `p` to get a proxy to a push supplier from the event channel, `v` to instantiate a `PushView`, `c` to connect the event channel, `d` to disconnect and `q` to quit. To run this example, a supplier of type `Push` or `Pull` must be running on another terminal, continuously sending data to the same event channel in order for `PushView` to receive the data. The supplier and consumer can be started in any order.

### Running the PullModel example

To run the PullModel example, enter:

```
prompt> vbj -DORBInitRef=EventService=file:
<fullpath of iorFilename> PullModel
```

Select `e` to bind to an event channel, `p` to get a proxy to a push consumer from the event channel, `m` to instantiate a `PullModel`, `c` to connect the event channel, `d` to disconnect and `q` to quit.

## Running the PullView example

To run the PullView, enter:

```
prompt>vbj -DORBInitRef=EventService=file:
<fullpath of iorFilename> PullView
```

Select `e` to bind to an event channel, `p` to get a proxy to a push supplier from the event channel, `v` to instantiate a PushView, `c` to connect the event channel. Then select `a` to pull asynchronously or `s` to pull synchronously. To exit, select `d` to disconnect and `q` to quit.

To run this example, a supplier of type Push or Pull must be running on another terminal, continuously sending data to the same event channel in order for PullView to receive the data. The supplier and consumer can be started in any order.

## PullSupply

The PullSupply class is derived from the PullSupplierPOA class and provides implementations for the main, pull and try\_pull methods. The pull method, shown below, returns a numbered “hello” message. The try\_pull method always sets the hasEvent flag to true and calls the pull method to provide the message. Once a PullSupply object is connected to an EventChannel, these methods are used by the channel to pull data from the supplier.

The main method, shown below, performs the usual VisiBroker ORB and POA creation, connects to the specified EventChannel, obtains a ProxyPullConsumer from the EventChannel, instantiates a PullSupply object, activates the PullSupply object on the POA, then connects this pull supplier to proxy pull consumers.

## Executing PullSupply

After compiling PullSupply.java and starting the Event Service, described in [“In-process event channel”](#), you can execute the supplier with the following command:

```
vbj -DORBInitRef = <channel_name> = file:<fullpath of
iOrFilename> PullSupply
```

## Implementation of the pull and try\_pull methods

```
// PullSupply.java
import org.omg.CosEventComm.*;
import org.omg.CosEventChannelAdmin.*;
import org.omg.PortableServer.*;
public class PullSupply extends PullSupplierPOA {
    private POA _myPOA;
    private PullConsumer _pullConsumer;
    private int _counter;
    PullSupply(PullConsumer pullConsumer, POA myPOA) {
        _pullConsumer = pullConsumer;
        _myPOA = myPOA;
    }
    public void disconnect_pull_supplier() {

System.out.println("Model::disconnect_pull_supplier()");
        try {

_myPOA.deactivate_object("PullSupply".getBytes());
        } catch(Exception e) {
            e.printStackTrace();
        }
    }
}
```

```

public org.omg.CORBA.Any pull() throws Disconnected {
    if(_pullConsumer == null) {
        throw new Disconnected();
    }
    try {
        Thread.currentThread().sleep(1000);
    } catch(Exception e) {
    }
    //org.omg.CORBA.Any message =
        new org.omg.CORBA.Any().from_string("Hello #"
+ ++_counter);
    org.omg.CORBA.Any message = _orb().create_any();
    message.insert_string("Hello #" + ++_counter);
    System.out.println("Supplier being pulled: " +
message);
    return message;
}
public org.omg.CORBA.Any
try_pull(org.omg.CORBA.BooleanHolder hasEvent) throws
    org.omg.CORBA.SystemException, Disconnected {
    hasEvent.value = true;
    return pull();
}
...

```

## Main method of PullSupply

```

// PullSupply.java
import org.omg.CosEventComm.*;
import org.omg.CosEventChannelAdmin.*;
import org.omg.PortableServer.*;
public class PullSupply extends PullSupplierPOA {
    ...
    public static void main(String[] args) {
        try {
            org.omg.CORBA.ORB orb =
org.omg.CORBA.ORB.init(args, null);
            // get a reference to the root POA
            POA rootPoa =

POAHelper.narrow(orb.resolve_initial_references("RootPOA")
);
            // Create policies for our persistent POA
            org.omg.CORBA.Policy[] policies = {

rootPoa.create_lifespan_policy(LifespanPolicyValue.PERSIST
ENT)
        };
            // Create myPOA with the right policies
            POA myPOA =
rootPoa.create_POA("event_service_poa",
                    rootPoa.the_POAManager(), policies);
            EventChannel channel = null;
            PullSupply model = null;   ProxyPullConsumer
pullConsumer = null;
            channel =

EventChannelHelper.narrow(orb.resolve_initial_references("
EventService"));
            System.out.println("Located event channel: " +

```

```

channel);
    pullConsumer =
channel.for_suppliers().obtain_pull_consumer();
    System.out.println("Obtained pull consumer: " +
pullConsumer);
    model = new PullSupply(pullConsumer, myPOA);

myPOA.activate_object_with_id("PullSupply".getBytes(),
model);
    myPOA.the_POAManager().activate();
    System.out.println("Created model: " + model);
    System.out.println("Connecting ...");

pullConsumer.connect_pull_supplier(model._this());
    } catch(Exception e) {
        e.printStackTrace();
    }
}
}

```

## PullConsume

The PullConsume class is derived from PullConsumerPOA class and provides a command line interface for pulling data from the PullSupply class. The code sample above shows how the application connects to any available EventChannel, obtains a ProxyPullSupplier, connects to the channel, and displays a command prompt. The table below summarizes the commands that may be entered.

Command	Description
a	Asynchronously pulls data from the event channel, using the <code>try_pull</code> method. If no data is currently available, the command will return with a no data message.
s	Synchronously pulls data from the event channel, using the <code>pull</code> method. If there is no data currently available, the command will block until data is available.
q	Disconnects from the channel and exits the tool.

## Executing PullConsume

After compiling `PullConsume.java` and starting the Event Service, described in ["In-process event channel"](#), you can execute the consumer with the following command:

```

vbj -DORBInitRef = <channel_name> = file:<fullpath of
ior_filename> PullConsume
// PullConsume.java
import org.omg.CosEventComm.*;
import org.omg.CosEventChannelAdmin.*;
import org.omg.PortableServer.*;
import java.io.*;
public class PullConsume extends PullConsumerPOA {
    public void disconnect_pull_consumer() {
        System.out.println("View.disconnect_pull_consumer");
    }
    public static void main(String[] args) {
        try {
            org.omg.CORBA.ORB orb =
org.omg.CORBA.ORB.init(args, null);

```

```

// get a reference to the root POA
POA rootPoa =

POAHelper.narrow(orb.resolve_initial_references("RootPOA")
);
// Create policies for our persistent POA
org.omg.CORBA.Policy[] policies = {

rootPoa.create_lifespan_policy(LifespanPolicyValue.PERSIST
ENT)
};
// Create myPOA with the right policies
POA myPOA =
rootPoa.create_POA("event_service_poa",
    rootPoa.the_POAManager(), policies );
EventChannel channel = null;
PullConsume view = null;
ProxyPullSupplier pullSupplier = null;
BufferedReader in = new BufferedReader(new
InputStreamReader(System.in));
channel
=EventChannelHelper.narrow(orb.resolve_initial_references
("EventService"));
System.out.println("Located event channel: " +
channel);
view = new PullConsume();

myPOA.activate_object_with_id("PullConsume".getBytes(),
view);
myPOA.the_POAManager().activate();
System.out.println("Created view: " + view);
pullSupplier =
channel.for_consumers().obtain_pull_supplier();
System.out.println("Obtained pull supplier: " +
pullSupplier);
System.out.println("Connecting...");
System.out.flush();
pullSupplier.connect_pull_consumer(view._this());
while(true) {
    System.out.print("-> ");
    System.out.flush();
    if (System.getProperty("VM_THREAD_BUG") !=
null) {
        while(!in.ready()) {
            try {
                Thread.currentThread().sleep(100);
            } catch(InterruptedException e) {
            }
        }
    }
    String line = in.readLine();
    if(line.startsWith("a")) {
        org.omg.CORBA.BooleanHolder hasEvent = new
org.omg.CORBA.BooleanHolder();
        org.omg.CORBA.Any result =
pullSupplier.try_pull(hasEvent);
        System.out.println("try_pull: " +
(hasEvent.value ? result.toString() :
"NO DATA"));
    }
}

```

```

        continue;
    } else if(line.startsWith("s")) {
        org.omg.CORBA.Any result =
pullSupplier.pull();
        System.out.println("pull: " + result);
        continue;
    } else if(line.startsWith("q")) {
        System.out.println("Disconnecting...");
        pullSupplier.disconnect_pull_supplier();
        System.out.println("Quitting...");
        break;
    }
    System.out.println("Commands: a
[a]synchronous pull\n" +
        "          s [s]ynchronous pull\n" +
        "          q [q]uit\n");
    }
} catch(Exception e) {
    e.printStackTrace();
}
}
}

```

## Starting the Event Service

When using VisiBroker for Java, the Event Service can be started by using the following command.

```

vbj [-Dvbroker.events.debug] [-
Dvbroker.events.interactive] [-
Dvbroker.events.max_queue_length=<number>] [-
Dvbroker.events.debug.factory] \
[-Dvbroker.events.vm_thread_bug]
com.inprise.vbroker.CosEvent.EventServer -ior <ior
filename> <channel name>

```

Option	Description
<code>-Dvbroker.events.debug</code>	Optional parameter that enables the output of debugging messages to stdout.
<code>-Dvbroker.events.interactive</code>	Specifies that the event channel is to execute in a console-driven, interactive mode.
<code>-Dvbroker.events.maxQueueLength</code>	Specifies the number of messages to be queued for slow consumers. The default maximum queue length is 100 messages for each consumer.
<code>-Dvbroker.events.factory</code>	Specifies that an event channel factory is to be instantiated instead of an event channel.
<code>channel_name</code>	The name of the channel or channel factory.

### Note

There is a known bug in some implementations of the Java Virtual Machine, including Solaris, that may cause this command to hang. If you experience difficulties, try specifying the `-Dvbroker.events.vm_thread_bug` parameter when you start the Event Service.

## Setting the queue length

In some environments, consumer applications may run slower than supplier applications. The `maxQueueLength` parameter prevents out-of-memory conditions by limiting the number of outstanding messages that will be held for each consumer that cannot keep up with the rate of messages from the supplier.

If a supplier generates 10 messages per second and a consumer can only process one message per second, the queue will quickly fill up. Messages in the queue have a fixed maximum length and if an attempt is made to add a message to a queue that is full, the channel will remove the oldest message in the queue to make room for the new message.

Each consumer has a separate queue, so a slow consumer may miss messages while another, faster consumer may not lose any. The code sample below shows how to limit each consumer to 15 outstanding messages.

```
vbj -Dvbroker.events.maxQueueLength=15
CosEvent.EventServer -ior myChannel.ior
MyChannel
```

### Note

If `maxQueueLength` is not specified or if an invalid number is specified, a default queue length of 100 is used.

## In-process event channel

In addition to running an `EventChannel` as a separate, stand-alone server, the Event Service allows you to create an `EventChannel` within your server or client application. This frees you from having to start a separate process to provide the `EventChannel` for your supplier or consumer applications.

For Java applications, an `EventLibrary` class is provided that provides methods for creating an `EventChannel` which, in turn, handles the loading of the necessary classes. To create an in-process `EventChannel` object within a supplier/consumer application, make the following call:

```
EventLibrary.create_Channel("MyChannel", whetherToDebug, max
QueueLength);
```

So, to create a channel named `MyChannel` with debugging off and a maximum queue length of 100, you would write:

```
EventLibrary.create_Channel("MyChannel", false, 100);
```

After this call completes, the resulting client application can bind to the `EventChannel` as it would bind to any other CORBA object.

For example, you might have a supplier application creating the channel in-process and want the consumer application to connect to the same channel. To accomplish this, you need to pass the channel object from the supplier application to the consumer application. To do this, convert the `EventChannel` object to an `ior` string and write the string to a file:

```
try {
EventChannel channel =
EventLibrary.create_Channel("MyChannel", false, 100);
PrintWriter pw = new PrintWriter(new
FileWriter(ior_filename));
pw.println(orb.object_to_string(channel));
pw.close();
```

```

    }
    catch(IOException e) {
        System.out.println("Error writing the IOR to file "
            ior_filename);
    }
}

```

The `ior_filename` specifies the name of the file to which the ior string of the channel will be written.

To run `PushModelChannel`:

```
vbj PushModelChannel <ior_filename>;
```

`PushModelChannel` is a push supplier. You can connect either a push consumer or pull consumer to the event channel created in `PushModelChannel`:

```
vbj -DORBInitRef=EventService=file:<fullpath of
ior_filename> PushView
```

where `<fullpath of ior_filename>` is the full path of the ior filename passed into `PushModelChannel` and `EventService` is the name (or identifier) bound to the ior contained in `<ior_filename>`. From within `PushView`, you can bind to the event channel as follows:

```
EventChannel channel =
    EventChannelHelper.narrow(orb.resolve_initial_references("
    EventService"));
```

## Using the in-process Event Channel

If your application uses the in-process event channel feature, you must add the following `import` statement:

```
import com.inprise.vbroker.CosEvent.*;
```

### Java EventLibrary class

The `EventLibrary` class provides several methods for creating an `EventChannel` within an application's process.

### Java example

The file `PushModelChannel.java` implements a push supplier that uses an in-process event channel. This application presents a command prompt and allows you to enter one of the commands shown below.

Command	Description
e	Creates an event channel.
s <number_of_seconds>	Sets the delay for the event channel to the number of seconds specified, which must be a non-negative number.
p	Obtains a push consumer proxy object.
m	Creates a <code>PushModelChannel</code> and activates it on the POA.
c	Connects the push supplier.
d	Disconnects the push consumer.
q	Quits the application.

The code sample below contains an excerpt from `PushModelChannel.java` that shows how you can use the `ChannelLib.create_channel` method.

```
public static void main(String[] args) {
    ...
}
```



```
channel =  
EventLibrary.create_channel("channel_server", false, 100);  
...
```

## Import statements

The following import statements should be used by applications that wish to use the Event Service:

```
import org.omg.CosEventComm.*;  
import org.omg.CosEventChannelAdmin.*;  
...
```



# Using the VisiBroker Server Manager

The VisiBroker Server Manager allows client applications to monitor and manage object servers, view and set properties at runtime for those servers, and view and invoke methods on Server Manager objects. The Server Manager uses elements known as *containers* which represent each major ORB component. A container can contain properties, operations, and even other containers.

## Note

Do not confuse the Server Manager container with J2EE containers. The Server Manager container is simply a logical grouping of ORB components and selected runtime properties.

## Getting Started with the Server Manager

This section covers enabling the Server Manager on a server, obtaining a Server Manager reference, working with containers, the Storage interface and the Server Manager IDL.

### Enabling the Server Manager on a server

A VisiBroker server is not enabled to be managed by default. The command which starts the server must set the following property to manage the server:

```
vbroker.orb.enableServerManager=true
```

The property can be specified either through the command-line or through the server's properties file.

### Obtaining a Server Manager reference

The first step in interacting with a Server Manager is to obtain a reference to a server's Server Manager. This reference points to the top level container. A client can obtain the reference in two ways:

- 1 A server runner can choose to name the Server Manager using the property option `vbroker.serverManager.name`. For example, the command:

```
prompt> vbj -Dvbroker.serverManager.name=BigBadBoss
Server
```

registers the Server Manager name "BigBadBoss" to the Smart Agent namespace. From this point onward, the client can bind to that name and start invoking operations on the reference. This property can be set in the properties file as well. This method of locating a Server Manager can be used when the client does not have object references to any other objects implemented by the server, for example:

```
import com.inprise.vbroker.ServerManager.*;

// returns reference to Server Manager "BigBadBoss" top
container.
```

```
Container topContainer =
ContainerHelper.bind(orb, "BigBadBoss");
```

- 2 If the client has an object reference to some other object implemented by the server, then the client can perform `_resolve_reference("ServerManager")` on that object to obtain the `ServerManager` for the ORB corresponding to the object. The following code fragment obtains the Server Manager's top-level container from the `Bank::AccountManager` object.

```
import com.inprise.vbroker.ServerManager.*;

// assume "manager" contains the reference to
AccountManager
// object. No need to narrow since AccountManager is a
// com.inprise.vbroker.CORBA.Object, however a narrow is
still
// required to convert returned Server Manager reference
to
// Container.
Container topContainer = ContainerHelper.narrow(
manager._resolve_reference("ServerManager"));
```

The client code needs to include the `servermgr_c.hh` to use the Server Manager interfaces.

## Working with Containers

Once a client application has obtained the reference to the top level container, it can:

- get, set, or add properties on top level container.
- iterate through containers inside top level container.
- get, set, or add containers.
- invoke operations defined in containers.
- get or set storage on the containers.
- restore or persist properties to property storage.

The top-level container does not support any properties or operations but just contains the ORB container. The ORB container in turn contains few ORB properties, a `shutdown` method, and other containers like `RootPOA`, `Agent`, `OAD`, and so forth.

See [“The Container Interface”](#) for information on how to interact with containers. [“Server Manager examples”](#) shows a Java example.

## The Storage Interface

Server Manager provides an abstract notion of storage that can be implemented in any fashion. Individual containers may choose to store their properties in the different ways. Some containers may choose to store their properties in a database, while others may choose to store them in files or in some other method. The `Storage` interface is defined in Server Manager IDL.

Every container uses the same methods to get and set storage, along with the ability to optionally set storage on all child containers of the parent. Similarly, each container uses the same methods to read and write its properties from the storage.

For information on the Storage Interface and its methods, see [“The Storage Interface”](#).

## The Container Interface

The container interface defines an interface and associated methods for logically grouping sets of objects, properties, operations, and so forth.

### Container class

```
public interface Container extends
    com.inprise.vbroker.CORBA.Object
    com.inprise.vbroker.ServerManager.ContainerOperations
    org.omg.CORBA.portable.IDLEntity
```

When using this class in your code, you must include the following include statements:

```
import com.borland.vbroker.ServerManager.*;
import
com.borland.vbroker.ServerManager.ContainerPackage.*;
```

### Container Methods for Java

A container can hold properties, operations, and other containers. Each major ORB component is represented as a container.

This section explains the Java methods that can be executed on the container interface. There are four categories:

- Methods related to property manipulation and queries
- Methods related to operations
- Methods related to children containers
- Methods related to storage

#### Methods related to property manipulation and queries

```
public String[] list_all_properties();
```

Returns the names of all the properties in the container as a `StringSequence`.

```
public com.inprise.vbroker.ServerManager.ContainerPackage.
Property[]
    get_all_properties();
```

Returns the `PropertySequence` containing the names, values, and read-write status of all the properties in the container.

```
public com.inprise.vbroker.ServerManager.ContainerPackage.
Property
    get_property(String name) throws
    com.inprise.vbroker.ServerManager.ContainerPackage.
    NameInvalid
```

Returns the value of the property **name** passed as an input parameter.

```
public void set_property(String name, org.omg.CORBA.Any
    value) throws com.inprise.vbroker.ServerManager.
    ContainerPackage.NameInvalid,
    com.inprise.vbroker.ServerManager.
```

```
ContainerPackage.ValueInvalid,
    com.inprise.vbroker.ServerManager.
ContainerPackage.ValueNotSettable
```

Sets the value of the property **name** to the requested **value**.

```
public void persist_properties(boolean recurse) throws
    com.inprise.vbroker.ServerManager.StorageException;
```

Causes the container to actually store its properties to the associated storage. If no storage is associated with the container, a `StorageException` will be raised. When it is invoked with the parameter `recurse=true`, the properties of the children containers are also stored into the storage. It is up to the container to decide if it has to store all the properties or only the changed properties.

```
public void restore_properties(boolean recurse) throws
    com.inprise.vbroker.ServerManager.StorageException;
```

Instructs the container to obtain its properties from the storage. A container knows exactly what properties it manages and it attempts to read those properties from the storage. The containers shipped with the ORB do not support restoring from the storage. You must create containers that support this feature yourself.

### Methods related to operations

```
public String[] list_all_operations();
```

Returns the names of all the operations supported in the container.

```
public com.inprise.vbroker.ServerManager.ContainerPackage.
    Operation[]
    get_all_operations();
```

Returns all the operations along with the parameters and the type code of the parameters so that the operation can be invoked with the appropriate parameters.

```
public com.inprise.vbroker.ServerManager.ContainerPackage.
    Operation
    get_operation(String name) throws
    com.inprise.vbroker.ServerManager.ContainerPackage.
    NameInvalid;
```

Returns the parameter information of the operation specified by **name** which can be used to invoke the operation.

```
public org.omg.CORBA.Any do_operation(
    com.inprise.vbroker.ServerManager.ContainerPackage.
    Operation op) throws
    com.inprise.vbroker.ServerManager.ContainerPackage.
    NameInvalid,
    com.inprise.vbroker.ServerManager.ContainerPackage.
    ValueInvalid,
    com.inprise.vbroker.ServerManager.ContainerPackage.
    OperationFailed;
```

Invokes the method in the operation and returns the result.

### Methods related to children containers

```
public String[] list_all_containers();
```

Returns the names of all the children containers of the current container.

```
public com.inprise.vbroker.ServerManager.ContainerPackage.
NamedContainer[]
    get_all_containers();
```

Returns all the children containers.

```
public com.inprise.vbroker.ServerManager.ContainerPackage.
NamedContainer
    get_container(String name) throws
com.inprise.vbroker.ServerManager.ContainerPackage.
NameInvalid;
```

Returns the child container identified by the **name** parameter. If there is not any child container with this name, a NameInvalid exception is raised.

```
public void add_container(
com.inprise.vbroker.ServerManager.ContainerPackage.
NamedContainer
    container) throws
com.inprise.vbroker.ServerManager.ContainerPackage.
NameAlreadyPresent,
com.inprise.vbroker.ServerManager.ContainerPackage.
ValueInvalid;
```

Adds the container as a child container of this **container**.

```
public void set_container(String name,
com.inprise.vbroker.ServerManager.Container value) throws
com.inprise.vbroker.ServerManager.ContainerPackage.
NameInvalid,
com.inprise.vbroker.ServerManager.ContainerPackage.
ValueInvalid,
com.inprise.vbroker.ServerManager.ContainerPackage.
ValueNotSettable;
```

Modifies the child container identified by the **name** parameter to one in the **value** parameter.

### Methods related to storage

```
void set_storage(in
com.inprise.vbroker.ServerManager.Storage s, in boolean
recurse);
```

Sets the storage of this container. If recurse=true, it also sets the storage for all its children as well.

```
com.inprise.vbroker.ServerManager.Storage get_storage();
```

Returns the current storage of the container.

## The Storage Interface

The Server Manager provides an abstract notion of *storage* that can be implemented in any fashion. Individual containers may choose to store their properties in databases, flat files, or some other means. The storage implementation included with the VisiBroker ORB uses a flat-file-based approach.

## Storage Interface Class and Methods

### Storage Class

```
public interface Storage extends
    com.inprise.vbroker.CORBA.Object
    com.inprise.vbroker.ServerManager.StorageOperations,
    org.omg.CORBA.portable.IDLEntity
```

The following include statements must appear in your code when using the Storage interface:

```
import com.inprise.vbroker.ServerManager.*;
import com.inprise.vbroker.ServerManager.ContainerPackage.*;
```

### Storage Interface Methods

```
public void open() throws
    com.inprise.vbroker.ServerManager.StorageException;
```

Opens the storage and makes it ready for reading and writing the properties. For the database-based implementation, logging into the database is performed in this method.

```
public void close() throws
    com.inprise.vbroker.ServerManager.StorageException;
```

Closes the storage. This method also updates the storage with any properties that have been changed since the last `Container::persist_properties` call. In database implementations, this method closes the database connection.

```
public com.inprise.vbroker.ServerManager.ContainerPackage.
Property[]
    read_properties() throws
    com.inprise.vbroker.ServerManager.StorageException;
```

Reads all the properties from the storage.

```
public com.inprise.vbroker.ServerManager.ContainerPackage.
Property
    read_property(String propertyName) throws
    com.inprise.vbroker.ServerManager.ContainerPackage.
    NameInvalid,
    com.inprise.vbroker.ServerManager.StorageException;
```

Returns the property value for **propertyName** read from the storage.

```
public void
    write_properties(com.inprise.vbroker.ServerManager.
    ContainerPackage.
    Property[] props) throws
    com.inprise.vbroker.ServerManager.StorageException;
```

Saves the property sequence into the storage.

```
public void write_property
    (com.inprise.vbroker.ServerManager.ContainerPackage.
    Property
    prop) throws
    com.inprise.vbroker.ServerManager.StorageException;
```

Saves the single property into the storage.



## Limiting access to the Server Manager

A client that obtains the Server Manager can control the entire ORB and hence security is paramount. The following properties can limit a user's access to the Server Manager functionality:

Property	Default Value	Description
<code>vbroker.orb.enableServerManager</code>	<code>false</code>	Setting this property to <code>True</code> enables the Server Manager.
<code>vbroker.serverManager.enableOperations</code>	<code>true</code>	Controls the permission to invoke operations in the containers. If set to <code>false</code> , the client will not be able to invoke <code>do_operation</code> on any container. This helps protect Server Manager from unintentional changes including shutting down the server by mistake.
<code>vbroker.serverManager.enable SetProperty</code>	<code>true</code>	Controls the setting of properties from the client. If set to the <code>false</code> , clients cannot modify any of the container properties.

## Server Manager IDL

Server Manager IDL is as shown below:

```

module ServerManager {
interface Storage;

exception StorageException {
    string reason;
};

interface Container
{
    enum RWStatus {
        READWRITE_ALL,
        READONLY_IN_SESSION,
        READONLY_ALL
    };

    struct Property {
        string name;
        any value;
        RWStatus rw_status;
    };
    typedef sequence<Property> PropertySequence;

    struct NamedContainer {
        string name;
        Container value;
        boolean is_replaceable;
    };
    typedef sequence<NamedContainer> NamedContainerSequence;

    struct Parameter {
        string name;

```

```

        any value;
    };
    typedef sequence<Parameter> ParameterSequence;

    struct Operation {
        string name;
        ParameterSequence params;
        ::CORBA::TypeCode result;
    };
    typedef sequence<Operation> OperationSequence;

    struct VersionInfo {
        unsigned long major;
        unsigned long minor;
    };

    exception NameInvalid{};
    exception NameAlreadyPresent{};
    exception ValueInvalid{};
    exception ValueNotSettable{};
    exception OperationFailed{
        string real_exception_reason;
    };

    ::CORBA::StringSequence list_all_properties();
    PropertySequence get_all_properties();
    Property get_property(in string name) raises (NameInvalid);
    void add_property(in Property prop)
    raises(NameAlreadyPresent, NameInvalid, ValueInvalid);
    void set_property(in string name, in any value)
    raises(NameInvalid, ValueInvalid, ValueNotSettable);

    ::CORBA::StringSequence get_value_chain(in string propertyName) raises
(NameInvalid);
    void persist_properties(in boolean recurse) raises (StorageException);
    void restore_properties(in boolean recurse) raises (StorageException);

    ::CORBA::StringSequence list_all_operations();
    OperationSequence get_all_operations();
    Operation get_operation(in string name)
    raises (NameInvalid);
    any do_operation(in Operation op)
    raises(NameInvalid, ValueInvalid, OperationFailed);

    ::CORBA::StringSequence list_all_containers();
    NamedContainerSequence get_all_containers();
    NamedContainer get_container(in string name)
    raises (NameInvalid);
    void add_container(in NamedContainer container)
    raises(NameAlreadyPresent, ValueInvalid);
    void set_container(in string name, in Container value)
    raises(NameInvalid, ValueInvalid, ValueNotSettable);

    void set_storage(in Storage s, in boolean recurse);
    Storage get_storage();

    readonly attribute VersionInfo version;
};

```

```

interface Storage
{
    void open() raises (StorageException);
    void close() raises (StorageException);
    Container::PropertySequence read_properties() raises
        (StorageException);
    Container::Property read_property(in string propertyName)
        raises (StorageException, Container::NameInvalid);
    void write_properties(in Container::PropertySequence p) raises
        (StorageException);
    void write_property(in Container::Property p) raises (StorageException);
};
};

```

## Server Manager examples

The following examples demonstrate how to:

- 1 Obtain a reference to the top-level container.
- 2 Get all containers and their properties recursively.
- 3 Get, set, and save properties on different containers.
- 4 Invoke the `shutdown()` method on the ORB container.

These example files can be found in:

```
<install_dir>/examples/vbroker/ServerManager/basic
```

The following example uses the `bank_agent` server. This server should be started by passing the property storage file. Initially the property file contains the properties to enable the Server Manager and set its name. The file is used by the Server Manager to update the properties if the user changes them. The properties to enable the Server Manager and set its name can be passed as command-line options, but the property file is required if any of the properties are to be modified and saved during the session.

Initially, the property file contains the following:

```
# server properties
vbroker.orb.enableServerManager=true
vbroker.serverManager.name=BigBadBoss
```

The server is started from the command-line:

```
prompt> vbj -DORBpropStorage=server.properties Server
```

### Obtaining the reference to the top-level container

This example uses the second, or `bind` method since the Server Manager has been started with a name (see [“Obtaining a Server Manager reference”](#)).

```
Container topContainer =
    ContainerHelper.bind(orb, "BigBadBoss");
```

### Getting all the containers and their properties

The following example shows how `get_all_properties`, `get_all_operations`, and `get_all_containers` can be used to query all

the properties and operations of all the containers below the current container recursively.

```
public void displayContainer(NamedContainer cont, boolean top) {
    // Get All Containers
    NamedContainer[] nc = cont.value.get_all_containers();

    // Get All Properties for the current container
    Property[] props=cont.value.get_all_properties();

    // Get All Operations for the current container
    Operation[] ops=cont.value.get_all_operations();

    ....
    // Now print all properties and operations and recurse
    // through all containers
}
```

## Getting and setting properties and saving them into the file

The following code fragment shows how to query a property of a container. If the container is not the top-level container, it needs to be reached first by traversing through all its parents from the top container. The get and set methods can be called only on the container which owns the property.

### Note

Properties with RW\_STATUS values of READONLY\_ALL are not settable.

```
public void getSetProperties(NamedContainer topCont) throws Exception {
    // Obtain the ORB container from top level container.
    Container orbCont=topCont.value.get_container("ORB").value;

    // Obtain the "iiop_tp" SCM container. This container is
    // contained as follows:
    // topCont->ORB->ServerEngines->iiop_tp->iiop_tp (the first
    // iiop_tp is the ServerEngine name)'

    Container iiopCont=orbCont.get_container(
        "ServerEngines").value.get_container(
        "iiop_tp").value.get_container(
        "iiop_tp").value;

    // Obtain the "bank_agent_poa" container. This container is
    // contained as follows:
    // topCont->ORB->RootPOA->Children->bank_agent_poa
    Container poaCont=orbCont.get_container(
        "RootPOA").value.get_container(
        "Children").value.get_container(
        "bank_agent_poa").value;

    // get the process Id property from ORB container
    Property procIdProp=orbCont.get_property("vbroker.orb.procId");

    // get the listener port property from iiop_tp container
    Property portProp=iiopCont.get_property(
```

```

        "vbroker.se.iiop_tp.scm.iiop_tp.listener.port");

    // get the upTime property from bank_agent_poa container
    Property upTimeProp=poaCont.get_property("upTime");
    ...
    // let the user modify listener port value
    org.omg.CORBA.Any portAny=orb.create_any();
    portAny.insert_long(newPort);
    iiopCont.set_property(
    "vbroker.se.iiop_tp.scm.iiop_tp.listener.port",portAny);
    ...
    // save the updated property to file

iiopCont.persist_properties(true);
}

```

## Invoking an operation in a Container

The ORB container supports the operation shutdown. The operation can be obtained by calling `get_operation` on the container.

```

public void invokeShutdown(NamedContainer topCont) throws
Exception {

    Container
    orbCont=topCont.value.get_container("ORB").value;

    System.out.println("Executing ShutDown ...");

    // Prepare parameter (boolean wait_for_completion)
    org.omg.CORBA.Any any=orb.create_any();
    any.insert_boolean(false);
    Parameter[] params=new Parameter[1];

    // Prepare result (void)
    params[0]=new Parameter("waitForCompletion",any);
    org.omg.CORBA.TypeCode result=orb.get_primitive_tc(
        org.omg.CORBA.TCKind.tk_void);

    // Prepare operation
    Operation op=new Operation("shutdown",params, result);

    // Invoke operation
    orbCont.do_operation(op);
}

```

The operation returned by the `get_operation` call has the default parameters. If the default values of the parameters are not the intended ones, these values should be modified before calling the `do_operation` method.

## Custom Containers

It is possible for a user application to define containers and add them to the Server Manager. The container manages two properties and defines one operation. It also uses its own storage for storing the properties. The two properties are:

Property	Description
<code>manager.lockAllAccounts</code>	This property has a read-write status of <code>READWRITE_ALL</code> , so it can be modified and takes effect while the server is running. The purpose of this property is to make <code>AccountManager</code> unavailable for client applications. The initial value of this property is read by the server on startup and saved to the same file when server shuts down/restarts.
<code>manager.numAccounts</code>	This property has a read-write status of <code>READONLY_ALL</code> , so it can only be read. The purpose of this property is to provide the number of <code>Accounts</code> in the <code>AccountManager</code> . The value of this property is not written to the storage.

The operation is:

Operation	Description
shutdown	Shuts down the server without starting it again. Before shutdown, the <code>manager.lockAllAccounts</code> property is written (persisted) to the property file.

For a complete example, go to:

`<install_dir>/examples/vbroker/ServerManager/custom_container/`

The main steps in writing custom containers is follows:

- 1 Implement the Container interface defined in Serve Manager IDL.
- 2 Instantiate the servant that implements the Container interface and activate it on a POA.
- 3 Obtain the reference to Server Manager top level container. Add the custom container to the Container hierarchy.

The server then can be started with the Server Manager enabled and a client can interact with the custom container.

If you want your application to implement its own storage, it has to implement the `Storage` interface defined in Server Manager IDL. The basic steps are same as implementing custom containers.

# Using VisiBroker Native Messaging

## Introduction

Native Messaging is a language independent, portable, interoperable, server side transparent, and OMG compliant two-phase invocation framework for CORBA and RMI/J2EE (RMI-over-IIOP) applications.

## Two-phase invocation (2PI)

In object-oriented vocabulary, invocations are method calls made on target objects. Conceptually, an invocation is made up of two communication phases:

- sending a request to a target in the first phase
- receiving a reply from the target in the second phase

In classic object-oriented distributed frameworks, such as CORBA, RMI/J2EE, and .NET, invocations on objects are *one-phased* (1PI), in which the sending and receiving phases are encapsulated together inside a single operation rather than exposed individually. In a one-phased invocation the client calling thread blocks on the operation after the first phase until the second phase completes or aborts.

If a client can be unblocked after the first phase, and the second phase can be carried out separately, the invocation is called *two-phased* (2PI). The operation unblocking before completing its two invocation phases is called a *premature return* (PR) in Native Messaging.

A 2PI allows a client application to unblock immediately after the request sending phase. Consequently, the client does not have to halt its calling thread and retain the transport connection while waiting for a reply. The reply can be retrieved or received by the client from an independent client execution context and/or through a different transport connection.

## Polling-Pulling and Callback models

In a two-phase invocation scenario, after sending out each request the client application can either actively poll and pull the reply using a poller object provided by the infrastructure, or the client can passively wait for the infrastructure to notify it and send back the reply on a specified asynchronous callback handler. These two scenarios are usually called the synchronous *polling-pulling* model and the asynchronous *callback* model respectively.

## Non-native messaging and IDL mangling

In non-native messaging, such as CORBA Messaging, two-phase invocations are not made with native operation signatures on native IDL or RMI interfaces. Instead, at different invocation phases, and with different reply retrieve models, client applications have to call various mangled operations.

For instance, in CORBA Messaging, to make a two-phase invocation of operation `foo (<parameter_list>)` on a target, the request sending is

not made with the native signature `foo()` itself, but it is made with either of the following mangled signatures:

```
// in polling-pulling model
sendp_foo(<input_parameter_list>);

// in callback model
sendc_foo(<callback_handler>, <input_parameter_list>);
```

The reply polling operation signature is:

```
foo(<timeout>,
    <return_and_output_parameter_list_as_output>);
```

The reply delivery callback operation signature is:

```
foo(<return_and_output_parameter_list_reversed_as_input>);
```

These mangled operations are either additional signatures added to the original application specified interface, or defined in additional type specific interfaces or valuetypes.

Problems with this non-native and mangling approach are:

- It ruins the intuitiveness of the original IDL interface and operation signatures.
- It could conflict with other operation mangling, for instance, in case of Java RMI.
- It could collide with operation signatures already used by the original IDL interface.
- It introduces interface binary incompatibility. For instance, interfaces with and without mangled signatures are not necessarily binary compatible in their language mapping.
- It does not respect the natural mapping between IDL operations and native GIOP messages, and therefore, introduces inconsistency and dilemmas when used with other OMG CORBA features, such as PortableInterceptor.

## Native Messaging solution

Native Messaging only uses *native* IDL language mapping and *native* RMI interfaces defined by applications, without any interface mangling and without introducing any additional application specific interface or valuetype.

For instance, in Native Messaging, sending a request to `foo(<parameter_list>)` and retrieving (or receiving) its reply in either the polling-pulling or callback models are made with the exact native operation `foo(<parameter_list>)` itself and are made on native IDL or RMI interfaces. No mangled operation signature and interfaces or valuetypes are introduced or used.

This pure native and non-mangling approach is not only elegant and intuitive but completely eliminates conflicts, name collision, and inconsistencies of operation signature mangling.

## Request Agent

Similar to the OMG Security and Transaction Services, Native Messaging is an object service level solution, which is based on an fully interoperable broker server, the *Request Agent*, and a client side portable request interceptor fully compliant with the OMG Portable Interceptor specification.



When making two-phase invocations, Native Messaging applications do not send requests directly to their target objects. Instead, request invocations are made on delegate *request proxies* created on a specified Request Agent. The request proxy is responsible for delegating invocations to their specified target objects, and delivering replies to client callback handlers or returning them later on client polling-pulling.

Therefore, a request agent needs to be known by client applications. Usually, this is accomplished by initializing the client ORB using OMG standardized ORB initialization command arguments:

```
-ORBInitRef RequestAgent=<request_agent_ior_or_url>
```

This command allows client applications to resolve the request agent reference from this ORB as an initial service, for instance:

```
// Getting Request Agent reference in Java
org.omg.CORBA.Object ref
    = orb.resolve_initial_references("RequestAgent");
NativeMessaging.RequestAgentEx agent
    = NativeMessaging.RequestAgentExHelper.narrow(ref);
```

By default, the URL of a request agent is:

```
corbaloc::<host>:<port>/RequestAgent
```

Here, <host> is the host name or dotted IP address of a RequestAgent server, and <port> is the TCP listener port number of this server. By default, NativeMessaging RequestAgent uses port 5555.

## Native Messaging Current

Similar to the OMG Security and Transaction Services, Native Messaging uses a thread local Current object to provide and access additional supplemental parameters for making two-phase invocations. These parameters include blocking timeout, request tag, cookie, poller reference, reply availability flag, and others. Semantic definitions and usage descriptions of these parameters are given in later sections. Similarly, the Native Messaging Current object reference can be resolved from an ORB as an initial service, for instance:

```
// Getting Current object reference in Java
org.omg.CORBA.Object ref =
    orb.resolve_initial_references("NativeMessagingCurrent");
NativeMessaging.Current current
    = NativeMessaging.CurrentHelper.narrow(ref);
```

## Core operations

A two-phase framework allows all normal invocations to be carried out in two separate phases manageable by client applications. Nevertheless, on fulfilling or using this two-phase invocation service, the framework and/or client may need some other primitive core functions from the framework. Operations used to access primitive core functions are called *core operations*. It is desirable that:

- Core operations are always accomplished in a single phase. An invocation on a core operation always blocks until it completes or aborts.
- Core operations are always orthogonal to any normal two-phase invocations that they are involved in.

In Native Messaging, all pseudo operations are reserved as core operations.

**Note**

In this document, if not explicitly stated, “invocation” or “operation” implies a non-core two way operation.

## StockManager example

The StockManager example is used in this section to illustrate the Native Messaging usage scenarios. This example is abridged from the full scale version that is shipped with the product in the <install\_dir>/examples/vbroker/NativeMessaging/stock\_manager directory, and it is provided to illustrate functionality that is equivalent to the CORBA Messaging StockManager example.

The following example assumes a server object has its IDL interface, StockManager, defined as follows:

```
// from: <install_dir>/examples/vbroker/NativeMessaging/
//      stock_manager/StockManager.idl
interface StockManager {
    boolean add_stock(in string symbol, in double quote);
    boolean find_closest_symbol(inout string symbol);
};
```

A conventional single-phase `add_stock()` or `find_closest_symbol()` call adds a stock symbol to or finds a symbol in the targeted stock manager server. The following is an example of the invocation code:

```
// invoke and block until return
boolean stock_added = stock_manager.add_stock("ACME",
100.5);
omg.org.CORBA.StringHolder symbol_holder
    = new omg.org.CORBA.StringHolder("ACMA");
boolean closest_found
    = stock_manager.find_closest_symbol(symbol_holder);
```

In the above one-phase invocation case, the invocations are blocked until the client receives its returns or exceptions.

Using Native Messaging, two-phase invocations can be made on the same stock manager server. Replies to these invocations can be retrieved or returned using the synchronous polling-pulling model or the asynchronous callback model, as illustrated in the [“Polling-pulling model”](#), and [“Callback model”](#).

**Note**

This document illustrates the StockManager example code in Java. The corresponding C++ code is available in the “Using VisiBroker Native Messaging” chapter of the *VisiBroker for C++ Developer's Guide*.

## Polling-pulling model

In the polling-pulling model, the result of a two-phase invocation is pulled back by client applications. The steps for Native Messaging polling-pulling two-phase invocations are summarized below.

- 1 Create a request proxy from a Native Messaging Request Agent. This proxy is created for a specific target object (a stock manager server in our example) and is used to delegate requests to the target.
- 2 Get the *typed receiver* or *<I> interface* of this proxy. This typed receiver is used by the client application to send requests to the proxy. The typed

receiver of a proxy supports the same IDL interface as the target object. In this example, the typed receiver supports the StockManager interface and can be narrowed down to a typed StockManager stub.

- 3 Perform the first invocation phase, making several invocations on the typed receiver stub. By default, invocations on a typed receiver are returned with dummy output and return values. This is called a *premature return*. Receiving a premature return from proxy's typed receiver without raising an exception indicates that a two-phase invocation has been successfully initiated. It indicates that the request has been accepted and assigned to a distinct poller object by the request agent. The poller object of a two-phase invocation is available from the local NativeMessaging Current. Like the typed receiver, all poller objects also support the same IDL interface as the target (in this example the StockManager).
- 4 Carry out the second phase of the invocation, polling availability and pulling replies back from the poller objects. The client application narrows the poller objects to their corresponding typed receiver stubs (StockManager in this example) and invokes the same operations as those invoked in the request sending phase. When making an invocation on poller objects input parameters are ignored. Also, the agent does not deliver new requests to the delegated target object. The agent treats all invocations made on the poller object as polling-pulling requests. Usually, a timeout value can be provided as a supplemental parameter through NativeMessaging Current to specify the maximum polling blocking timeout. If the reply is available before the timeout, the polling invocation will receive a *mature return* with output parameters and a return result from the real invocation. Otherwise, if the reply is not available before the timeout expires, the poll ends up with a premature return again. Applications should use the `reply_not_available` attribute of Native Messaging Current to determine whether a polling return is premature.

The following code sample illustrates how to use Native Messaging to make polling-pulling two-phase invocations on a stock manager object:

```
// from: <install_dir>/examples/vbroker/NativeMessaging/
//       stock_manager/PollingClient.java

// 1. create a request proxy from the request agent for
//     making
//     non-blocking requests on targeted stock_manager
//     server.
RequestProxy proxy = agent.create_request_proxy(
    stock_manager, "", null,
    new NameValuePair[0]);

// 2. Get the request receiver of the proxy
StockManager stock_manager_rcv
    = StockManagerHelper.narrow(proxy.the_receiver());

// 3. send two requests to the receiver, and get
//     their reply pollers from the Native Messaging
//     Current.
StockManager[] pollers = new StockManager[2];
stock_manager_rcv.add_stock("ACME", 100.5);
pollers[0] =
    StockManagerHelper.narrow(current.the_poller());
StringHolder symbol_holder = new StringHolder("ACMA");
stock_manager_rcv.find_closest_symbol(symbol_holder);
pollers[1] =
```

```

StockManagerHelper.narrow(current.the_poller());

// 4. Poll/pull the two associated replies.
current.wait_timeout(max_timeout);

boolean stock_added;
do { stock_added = pollers[0].add_stock("", 0.0); }
while(current.reply_not_available());

boolean closest_found;
do { closest_found =
pollers[1].find_closest_symbol(symbol_holder); }
while(current.reply_not_available());

```

### Note

- In Native Messaging, the request sending phase and the reply polling-pulling phase of a two-phase invocation all use the same operation signature. This operation used by both phases of a two-phase invocation is exactly the same *native* operation defined on the actual target's IDL interface.
- Poller objects are normal CORBA objects with location transparency. Therefore, in Native Messaging, it is not necessary to carry out the request sending phase and the reply polling phase of a two-phase invocation in same client execution context and through same transport connection.
- If there is an exception in polling-pulling phase, the application should use the Current `reply_not_available` attribute to determine whether the exception is the result of a reply polling-pulling failure, or the successful pulling of a real exceptional result of the delegated request. `TRUE` indicates that the exception is a polling-pulling failure between the client and agent. `FALSE` indicates that the exception is the real result of the delegated request.
- In a premature return, Native Messaging sets all non-primitive output parameters and the return value to null. This is similar to the OMG non-exception handling C++ mapping except Native Messaging uses a local Current object rather than the CORBA Environment.

Additional features, variances of the polling-pulling model, and Native Messaging API syntax and semantics specification are discussed in [“Advanced Topics”](#) and [“Native Messaging API Specification”](#).

## Callback model

Using the Native Messaging callback model, applications are unblocked immediately after they send out requests to a proxy's typed receiver. Replies to these invocations are delivered to a callback reply recipient that is specified upon creating the request proxy.

The steps to make Native Messaging two-phase invocations in the callback model are summarized below:

- 1 Create a request proxy from a Native Messaging Request Agent. This proxy is created for a specific target object. Like the polling-pulling model, this proxy will be used to delegate requests to the specified target. A reply recipient callback handler, which is a null reference in the polling-pulling model, is also specified on creating this request proxy. The request agent will deliver to the callback handler any newly available replies to requests delegated by this proxy.

- 2 Like the second step in the polling-pulling model, get the *typed receiver*, or *<I> interface*, of this proxy and narrow it down to a typed *<I> stub* (a StockManager stub in this example).
- 3 Like the third step in the polling-pulling model, perform the first invocation phase by making several invocations on the proxy's typed receiver stub. By default, invocations on a typed receiver are returned with dummy output and return values. This is called a *premature return*. A premature return on a proxy's typed receiver without an exception indicates a two-phase invocation has been successfully initiated.
- 4 Complete the second phase of the invocation, which is to receive replies. In the callback model, this is done asynchronously in a completely independent execution context. Client applications implement and activate a reply recipient object. This callback object is type unspecific, that is it does not depend on the real target's IDL interface. The key operation of this callback handler is the `reply_available()` method which is discussed below after the code sample.

The following code sample illustrates the first three steps for using Native Messaging to make callback model two-phase invocations on a stock manager object:

```
// from: <install_dir>/examples/vbroker/NativeMessaging/
//       stock_manager/CallbackClient.java

// get type independent callback handler reference
NativeMessaging.ReplyRecipient reply_recipient = ...;
// 1. create a request proxy from the request agent for
// making non-blocking requests on targeted stock_manager
server.
RequestProxy proxy = agent.create_request_proxy(
    stock_manager, "", reply_recipient,
    new NameValuePair[0]);

// 2. Get the request receiver of the proxy
StockManager stock_manager_rcv
    = StockManagerHelper.narrow(proxy.the_receiver());

// 3. send two requests to the receiver.
stock_manager_rcv.add_stock("ACME", 100.5);
StringHolder symbol_holder = new StringHolder("ACMA");
stock_manager_rcv.find_closest_symbol(symbol_holder);
```

Here, the `reply_recipient` callback handler is a `NativeMessaging::ReplyRecipient` object regardless of the specific application target types. The `ReplyRecipient` interface is defined as:

```
// from: <install_dir>/idl/NativeMessaging.idl

interface NativeMessaging::ReplyRecipient {
    void reply_available(
        in object reply_holder,
        in string operation,
        in sequence<octet> the_cookie);
};
```

The `reply_holder` parameter of `reply_available()` is called a *reflective callback* reference, which is the same as a reply poller object of the polling-pulling model and can be used by the `reply_available()` implementation to pull back the reply result in the same way a polling-pulling client would pull back a reply result from a poller object.

**Note**

In delivering replies to a callback handler, Native Messaging uses the *double dispatch* pattern to *reverse* the callback model into a polling-pulling model. Here, a reply recipient implementation makes a second (reflective) callback on a typed `reply_holder` reference to retrieve the reply.

The following code sample is an example implementation of `reply_available()` method:

```
// from: <install_dir>/examples/vbroker/NativeMessaging/
//       stock_manager/AsyncStockRecipient.java

void reply_available(
    omg.org.CORBA.Object reply_holder,
    String operation,
    byte[] cookie)
{
    StockManager poller
        = StockManagerHelper.narrow(reply_holder);

    // retrieve response using reflective callback
    if( operation.equals( "add_stock" ) ) {
        // retrieve a add_stock() return
        boolean stock_added = poller.add_stock("", 0.0);
        ...
    }
    else
        if( operation.equals("find_closest_symbol" ) ) {
            StringHolder symbol_holder = new
StringHolder("");
            // retrieve a find_closest_symbol() return
            boolean closest_found
                =
poller.find_closest_symbol(symbol_holder);
            ...
        }
    }
}
```

**Note**

- In Native Messaging, the request sending phase and the reply receiving phase of a two-phase invocation both use the same operation. The operation used by both phases of a two-phase invocation is exactly the same *native* operation defined on the actual target's IDL interface.
- Reply recipient objects are normal CORBA objects and are location transparent. Therefore, in Native Messaging, the reply recipient callback object is not necessarily located within the request sending client process.
- If an exception is raised when the `reply_available()` implementation retrieves a reply from the `reply_holder`, the application should use the `Current.reply_not_available` attribute to determine whether the exception reports retrieving a failure or a successful reply retrieval of a real exceptional result of the delegated request. `TRUE` indicates that this exception is the result of a reply retrieval failure between the client and agent. `FALSE` indicates that this exception is a real result of delegated request.

- Reply retrieval operations on `reply_holder` should only be made within the scope of the `reply_available()` method. Once the application returns from `reply_available()`, the `reply_holder` may no longer be valid.

Additional features, variances of the polling-pulling model, and the Native Messaging API specification are discussed in [“Advanced Topics”](#) and [“Native Messaging API Specification”](#).

## Advanced Topics

### Group polling

As illustrated in previous sections, multiple requests can be delegated by a given request proxy. However, as different requests take different processing time, replies from them are not necessarily ready in the order in which they were invoked. Instead of polling individual requests one by one, group polling allows a polling client application, which has multiple requests delegated by a given request proxy, to determine the availability of replies in an multiplexed aggregation.

In order to participate in group polling, a request sent to a given proxy needs to be tagged. Request tags are assigned by clients to identify requests in the scope of their group, namely the request proxy. Native Messaging does not impose any constraint on request tag content, except that they must be unique within the scope (request proxy). Untagged requests (requests with empty tags) do not participate in group polling, and the availability of their replies is not reported by group polling results.

The steps for using group polling are summarized below.

- 1 Send tagged requests. To tag a request, a client application simply sets the `request_tag` attribute of the local Native Messaging Current object before making each invocation on the typed receiver interface (before delivering each request). The content of each request tag is specified by application for its own convenience, as long as it is unique within its scope (proxy).
- 2 Poll reply availability on the request proxy, instead of on any individual poller, by calling the proxy's `poll(max_timeout, unmask)` operation. This operation will block until timeout, or until any tagged requests delegated by this proxy are ready for mature return, at which time their tags will be put in the returned request tag sequence. An empty tag sequence return indicates a timeout has expired.
- 3 Retrieve reply results from individual pollers, which have reported that they are ready for mature return by the group polling return result.

The following code sample illustrates above steps of using Native Messaging group polling feature:

```
// from: <install_dir>/examples/vbroker/NativeMessaging/
//      stock_manager/GroupPollingClient.java
StockManager pollers[] = new StockManager[2];
// send one tagged request
current.request_tag("0".getBytes());
stock_manager_rcv.add_stock("ACME", 100.5);
pollers[0] =
    StockManagerHelper.narrow(current.the_poller());

// send another tagged request
current.request_tag("1".getBytes());
```

```

StringHolder symbol_holder = new StringHolder("ACMA");
Stock_manager_rcv.find_closest_symbol(symbol_holder);
pollers[1] =
StockManagerHelper.narrow(current.the_poller());

// polling request availability on proxy and retrieve
their replies
byte[][] tags = null;
while(true) {
    // polling availability
    try {
        tags = proxy.poll(max_timeout, true);
    }
    catch(PollingGroupIsEmpty e) {
        proxy.destroy(true);
        break;
    }
    // retrieve replies
    for(int i=0;i<tags.length;i++) {
        int id = Integer.parseInt(new String(tags[i]));

        switch(id) {
            case 0: // the first tagged request sent above
                boolean stock_added;
                stock_added = pollers[0].add_stock("", 0.0);
                break;

            case 1: // the second tagged request sent above
                boolean closest_found;
                closest_found
                    =
pollers[1].find_closest_symbol(symbol_holder);
                break;

            default:
                break;
        }
    }
}

```

### Note

- After each invocation, the Current request\_tag attribute is automatically reset to empty or null.
- Try to initiate a 2PI on a proxy with a request\_tag already used by another 2PI or the proxy will end up with a CORBA BAD\_INV\_ORDER exception with minor code NativeMessaging::DUPLICATED\_REQUEST\_TAG.
- The unmask parameter of the poll() operation on a request proxy specifies whether the poll() should unmask all mature requests. If they are unmasked, they will not be involved and reported by the next poll().
- If all requests on a proxy are not tagged or unmasked, poll() will raise a PollingGroupIsEmpty exception.



## Cookie and reply de-multiplexing in reply recipients

As illustrated in previous sections, multiple requests can be delegated by a given request proxy. In the callback model, all replies to these requests will be sent back to the same reply recipient object specified on creating the proxy. The challenge is how the client demultiplexes different replies on one ReplyRecipient callback handler.

Applications using OMG CORBA Messaging also face the same challenge. To avoid activating many callback objects, CORBA Messaging suggests that applications use a POA default servant or servant manager to manipulate callback objects, and assign different object IDs to different callback references. Although this avoids many callback objects being activated in the reply recipient process, it is inflexible and far from an efficient scenario, because it requires an object reference to be created and marshaled for sending each callback request.

Native Messaging supports two demultiplexer mechanisms, which can be used either together or alone depending on the required demultiplexer granularity. A coarse grained demultiplex, but handy mechanism, is simply demultiplexing by operation signature, which is available within the ReplyRecipient's `reply_available()` callback method. This is the mechanism used in some of the previous examples.

A more effective demultiplexing mechanism in the Native Messaging callback scenario is using *request cookies*. A request cookie is an octet sequence (or byte array). Its content is specified by client applications on the Native Messaging's Current object before sending a request. The specified cookie is passed to the reply recipient's `reply_available()` method on delivering the reply of that request. There is no constraint on the content of a cookie, not even a uniqueness requirement. Contents of cookies are decided solely by applications for their own convenience and efficiency on callback demultiplexing.

The following code sample illustrates how to assign cookie to a request:

```
// send a requests with a cookie
current.the_cookie("add stock".getBytes());
stock_manager_rcv.add_stock("ACME", 100.5);

// send another request with a different cookie
current.the_cookie("find symbol".getBytes());
StringHolder symbol_holder = new StringHolder("ACMA");
stock_manager_rcv.find_closest_symbol(symbol_holder);
```

The following code sample illustrates how to use attach cookies to demultiplex by reply recipient:

```
void reply_available(
    omg.org.CORBA.Object reply_poller,
    String operation,
    byte[] cookie)
{
    StockManager poller
        = StockManagerHelper.narrow(reply_poller);

    String id = new String(cookie);

    if( id.equals( "add stock" ) ) {
        boolean stock_added.add_stock("", 0.0);
    }
}
```

```

        ...
    }
    else
    if( id.equals("find symbol") ) {
        StringHolder symbol_holder = new StringHolder("");
        boolean closest_found
            = poller.find_closest_symbol(symbol_holder);
        ...
    }
}

```

## Evolving invocations into two-phases

Compared to conventional single-phase invocations, two-phase invocations incur additional reply polling communication round trips. For a long duration heavyweight task, latency from few additional communication round trips is insignificant. However, for a lightweight transient invocation, this latency can be undesirable.

It is ideal for applications if lightweight transient invocations can be completed in a single-phase without incurring additional latency, and heavyweight long duration invocations can automatically be performed in two separated phases without holding client execution context and transport connection.

In Native Messaging, this can be achieved with the *evolve into two-phase invocation* feature. By default, invocations on a proxy's typed receiver always end up with premature returns along with their reply results to be polled back or delivered through callbacks later in a separate invocation phase. The *evolve into two-phase* feature allows invocations on a proxy's typed receiver to block and end up with a mature return if it can be accomplished before a specified timeout expires. Otherwise, if the invocation cannot complete before the timeout expires, it will evolve into a two-phase invocation by taking a premature return. To determine whether an invocation on a proxy's typed receiver has evolved into a two-phase invocation, the application can examine the `reply_not_available` attribute of the local Native Messaging Current object after the return.

To use this feature:

- The request proxy should be created with a `WaitReply` property with a value of `TRUE`.
- Set the `wait_timeout` attribute of Native Messaging Current to a non-zero value (milliseconds) before the invocations.
- After each invocation on the typed receiver, determine whether a return is premature by examining the `reply_not_available` attribute of the local Native Messaging Current object after each invocation.
- If a return is premature, get the returned poller object from the local Current to poll the reply in separate phase later.

The following code sample illustrates how to use the evolve invocations into two-phases:

```

// Create a request proxy with WaitReply property TRUE
org.omg.CORBA.NameValuePair nv = new
org.omg.CORBA.NameValuePair();
nv.id = new String("WaitReply");
nv.value = orb.create_any();
nv.value.insert_boolean(true);
org.omg.CORBA.NameValuePair[] props

```

```

        = new org.omg.CORBA.NameValuePair[] {nv};

RequestProxy proxy
    = agent.create_request_proxy(stock_manager, "", null,
    props);

// Get the typed receiver of this proxy
StockManager stock_manager_rcv
    = StockManagerHelper.narrow(proxy.the_receiver());

// Set wait_timeout attribute to 3 seconds
current.wait_timeout(3000);

// make an invocation on the receiver.
boolean stock_added = stock_manager_rcv.add_stock("ACME",
100.5);

// check whether it has evolved into a two-phase
invocation.
if( current.reply_not_available() == false ) {
    // It is not evolved. The return above is mature.
    // The job has done.
    return;
}

// It has evolved into a two-phase invocation.
// We should get the poller and poll its reply.
StockManager poller =
StockManagerHelper.narrow(current.the_poller());
do { stock_added = poller.add_stock("", 0.0); }
while(current.reply_not_available())

```

## Notes

- If an operation on a proxy's typed receiver can be completed before it evolves into a two-phase invocation on timeout, there will be no poller generated, nor will a callback be made on the reply recipient to deliver the reply.
- If an exception is raised from blocking on a proxy or polling reply, the application should use the `reply_not_available` attribute of Native Messaging Current to determine whether the exception reports a request delivering or reply polling failure or if it is a real result of delegating the request. A value of `TRUE` for this attribute indicates that this exception is a reply delivering or polling failure between the client and agent. `FALSE` indicates that this exception is a real result of delegating the request.

## Reply dropping

In the callback model, by default, a request agent sends whatever result, return or exception, of the invocation back to the reply recipient. Reply dropping allows specified types of reply results to be filtered out. This is useful, for instance, if applications want to invoke one-way requests with no result to be returned, but would still be notified if any invocations fail.

Native Messaging allows applications to specify a `ReplyDropping` property on creating a request proxy. This property specifies which types of returns should be filtered out from being sent to the reply recipient. The value of this property is an octet (or byte) with the following filtering rules:

- if( value & 0x01 == 0x01 ) drop normal replies

- if( value & 0x02 == 0x02 ) drop system exceptions
- if( value & 0x04 == 0x04 ) drop user exceptions

For example, a value of 0x06 for this property lets the request agent drop all exceptions, system as well as user, on requests delegated by this proxy.

The following example code illustrates setting the ReplyDropping property:

```
// Create a request proxy with ReplyDropping property
// with value 0x01 (dropping all normal replies).
org.omg.CORBA.NameValuePair nv = new
org.omg.CORBA.NameValuePair();
nv.id = new String("ReplyDropping");
nv.value = orb.create_any();
nv.value.insert_octet(0x01);
org.omg.CORBA.NameValuePair[] props
    = new org.omg.CORBA.NameValuePair[] {nv};

RequestProxy proxy
    = agent.create_request_proxy(stock_manager, "",
        reply_recipient, props);
...

```

### Notes

- Reply dropping only applies to the callback model. If the `reply_recipient` reference passed to the `create_request_proxy()` is null, the reply dropping property is ignored.
- If the value of the reply dropping property in `create_request_proxy()` is not 0x00, and the `reply_recipient` reference is not *null*, invocation on this proxy's typed receiver will not return a poller object on Native Messaging Current.

## Manual trash collection

By default, a poller object will be trashed immediately after a polling operation on it results in a mature return. In the callback model, once the callback is returned, a request agent also trashes the poller regardless of whether the application has retrieved the reply within the callback `reply_available()` operation. Polling on a trashed object raises a CORBA `OBJECT_NOT_EXIST` exception and the Current `reply_not_available` attribute is set to `TRUE`.

If a request proxy is created with a `RequestManualTrash` property of value `TRUE`, poller objects of requests delegated by this proxy are not trashed automatically. Polling on these poller objects after a reply becomes available is idempotent, returning the same result every time.

These poller objects can be manually trashed if an application no longer needs them. To manually trash poller objects, applications simply call the `destroy_request()` operation on the request agent, with the poller to be trashed as a parameter. For example,

```
agent.destroy_request(poller);
```

### Note

Pollers of requests delegated by an auto-trashing proxy can also be trashed manually. This makes sense when replies on these pollers are either not yet available or have not been polled back.

## Unsuppressed premature return mode

The key concept of Native Messaging is unblocking from a native operation after its first invocation phase. In Native Messaging, this is called *premature return*. There are two premature return modes in Native Messaging: *suppressed* mode and *unsuppressed* mode. All of the discussions so far used the default suppressed mode. In suppressed mode, the premature return is a normal operation return, except that it contains dummy output and return values. This is similar to an exceptional return in non-exception handling in the OMG C++ mapping, except that Native Messaging uses a thread local Current object instead of an additional Environment parameter.

Suppressed premature return mode is handy, however, it requires client-side mapping support. Namely, it assumes the IDL precompiler generated client-side stub code catches and suppresses premature return exceptions. To port client applications to an ORB, its IDL precompiler does not generate premature return suppressed client-side stub code, so the unsuppressed premature return mode can be used.

In Native Messaging unsuppressed premature return mode, a native operation is unblocked by simply raising an RNA exception, that is a CORBA NO\_RESPONSE exception with minor code REPLY\_NOT\_AVAILABLE. To use unsuppressed premature return mode, an application needs to turn off suppressed mode by calling `suppress_mode(false)` on Native Messaging Current, and it needs to catch and handle the RNA exceptions accordingly.

### Note

To ensure that the code is portable to both suppressed and unsuppressed modes, it is recommended that applications use the Current `reply_not_available` attribute in unsuppressed mode, rather than the RNA exception and minor code to determine the maturity of a return.

The following example code illustrates the StockManager polling example in unsuppressed mode. This code is not only portable to all ORBs, but also portable to suppressed mode.

```
void yield_non_rna(org.omg.CORBA.NO_RESPONSE e) {
    if(e.minor !=
NativeMessaging.REPLY_NOT_AVAILABLE.value) {
        throw e;
    }
}
...
// turn off suppress mode
current.suppress_mode(false);

// send several requests to the receiver, and get
// their reply pollers from the Native Messaging Current.
StockManager pollers[2];
try{ stock_manager_rcv.add_stock("ACME", 100.5); }
catch(org.omg.CORBA.NO_RESPONSE e) { yield_non_rna(e); }
pollers[0] =
StockManagerHelper.narrow(current.the_poller());
StringHolder symbol_holder = new StringHolder("ACMA");
try{
stock_manager_rcv.find_closest_symbol(symbol_holder); }
catch(org.omg.CORBA.NO_RESPONSE e) { yield_non_rna(e); }
pollers[1] =
StockManagerHelper.narrow(current.the_poller());

// poll the two associated replies.
```

```

current.wait_timeout(max_timeout);

boolean stock_added;
do { try{ stock_added = pollers[0].add_stock("", 0.0) }
    catch(org.omg.CORBA.NO_RESPONSE e) { yield_non_rna(e);
    } }
while(current.reply_not_available());

boolean closest_found;
do { try{ closest_found =
pollers[1].find_closest_symbol(symbol_holder) }
    catch(org.omg.CORBA.NO_RESPONSE e) { yield_non_rna(e);
    } }
while(current.reply_not_available());

```

## Suppress poller generation in callback model

By default, pollers are generated even in the callback model. This allows:

- Applications to trash a request before it completes.
- Applications to retrieve replies independent of their reply recipients.

However, generating and sending back poller references incurs additional overhead. Native Messaging allows applications to suppress (disable) poller reference generation in the callback model.

To suppress a poller in the callback model, applications only need to create a request proxy with the `CallbackOnly` property set to `TRUE`. In this case null pollers are returned.

# Native Messaging API Specification

## Note

Several operations and attributes in the Native Messaging IDL definition are not specified in this document. They are either value added features, deprecated features, or reserved for further extension.

## Interface RequestAgentEx

This is the interface of the Native Messaging Request Agent. A request agent is responsible for delegating invocations to their specified target object and delivering return results to client callback handlers or returning them later on client polling. See [“Request Agent”](#) for more information.

### create\_request\_proxy()

```

RequestProxy
create_request_proxy(
    in object target,
    in string repository_id,
    in ReplyRecipient reply_recipient,
    in PropertySeq properties)
raises(InvalidProperty);

```

The `create_request_proxy()` method creates a request proxy to delegate two-phase invocations to the specified target object.

Argument	Description
<code>target</code>	The target of all requests to be delegated by this proxy.
<code>repository_id</code>	This is the assigned repository ID of the typed receiver, reply poller, and reply holder from this proxy. If this parameter is an empty string, the target's repository ID is used. This ID is used by Native Messaging to fulfill <code>_is_a()</code> semantics on typed receiver, reply poller, and reply holder.
<code>reply_recipient</code>	The reply recipient callback handler. When replies become available the request agent calls back its <code>reply_available()</code> operation to send back reply results. A <code>null_reply_recipient</code> implies the polling-pulling model.
<code>properties</code>	Properties to specify non-default semantics of the proxy. Supported properties include: <ul style="list-style-type: none"> <li>• <code>WaitReply</code>: A boolean property with default value <code>FALSE</code>. See <a href="#">"Evolving invocations into two-phases"</a> for more information.</li> <li>• <code>RequestManualTrash</code>: A boolean property with default value <code>FALSE</code>. See <a href="#">"Manual trash collection"</a> for more information.</li> <li>• <code>ReplyDropping</code>: An octet property with default value <code>0x00</code>. See <a href="#">"Reply dropping"</a> for more information.</li> <li>• <code>CallbackOnly</code>: A boolean property with default value <code>FALSE</code>. See <a href="#">"Suppress poller generation in callback model"</a> for more information.</li> </ul>

Exception	Description
<code>InvalidProperty</code>	This exception indicates that an invalid property name or value is used in the properties list. The property name is available from the exception.

## destroy\_request()

```
void
destroy_request(
    in object poller)
    raises(RequestNotExist);
```

This method is used to manually trash a poller object. See [“Manual trash collection”](#) for more information.

Argument	Description
poller	The poller to be trashed.

Exception	Description
RequestNotExist	This exception indicates the poller to be trashed is not available.

## Interface RequestProxy

Request proxies are created by an application from a request agent in order to delegate requests to the specified target and with the specified semantic properties. See [“create\\_request\\_proxy\(\)”](#).

### the\_receiver

```
readonly attribute object the_receiver;
```

This attribute is the proxy's typed receiver reference. The type receiver of a proxy supports the same IDL interface as the specified target and is where applications send their requests to be delegated by the proxy.

### Note

- By default, calling operations on a proxy's typed receiver initiates two-phase invocations to be delegated by this proxy. These calls will be unblocked and yield distinct reply pollers.
- If the proxy is created with a `WaitReply` property value of `TRUE` and the request on `the_receiver` is called with a non-zero `wait_timeout`, the request agent will try to delegate the request as single-phase invocation before the timeout expires. If the agent does not receive a reply from the target before the timeout expires, it will unblock the client and the request will evolve into a two-phase invocation. After unblocking from a call on `the_receiver`, applications can use the `CurrentReplyNotAvailable` attribute to determine whether the request has evolved into a two-phase invocation. See [“reply\\_not\\_available”](#).
- IDL one-way operations only have one invocation phase intrinsically, therefore, one-way invocations on a proxy's typed receiver do not yield poller objects. The agent simply forwards them to their targets without going through a second invocation phase.
- Core operations on a proxy's typed receiver are handled synchronously; they will be blocked until a mature return or exception. Calling core operations on typed receivers does not imply initiating two-phase invocations. For instance, a `_non_existent()` call on a proxy's typed receiver only implies a ping on the receiver itself, not on the real target.



## poll()

```

RequestIdSeq
poll(
    in unsigned long timeout,
    in boolean unmask)
    raises (PollingGroupIsEmpty);

```

This method performs group polling. See [“Group polling”](#) for more information.

Argument	Description
timeout	specifies the maximum length of time, in milliseconds, that this method will wait for any tagged request to become available. If no tagged request becomes available before the timeout expires an empty RequestIdSeq is returned.
unmask	specifies whether a tagged request, its tag is in the returned sequence, should be unmasked. Once unmasked, a tagged request will no longer be involved in subsequent group polling.

Exception	Description
PollingGroupIsEmpty	This exception indicates there are no tagged or unmasked requests pending on this proxy.

## destroy()

```

void
destroy (
    in boolean destroy_requests);

```

This method destroys a request proxy.

Argument	Description
destroy_requests	if TRUE, all requests delegated by this proxy are trashed.

## Local interface Current

A local Native Messaging Current object is used by an application to specify and access additional information before and after a two-phase invocation. The Current object can be resolved from the local ORB as an initial reference. See [“Native Messaging Current”](#) for more information.

## suppress\_mode()

```

void
suppress_mode (
    in boolean mode);

```

This sets the current premature return mode. In suppressed mode, two-phase invocations are unblocked after the first phase in a normal return, except that the return contains dummy output and return values. In unsuppressed mode, two-phase invocations are unblocked after the first phase by an RNA exception (a CORBA NO\_RESPONSE exception with minor code of NativeMessaging::REPLY\_NOT\_AVAILABLE). See [“Unsuppressed premature return mode”](#) for more information.

Argument	Description
mode	specifies whether the suppressed mode is used.

## wait\_timeout

```
attribute unsigned long wait_timeout;
```

This attribute specifies the maximum number of milliseconds a two-phase invocation will block on sending a request or on polling a reply. On timeout, Native Messaging unblocks the call with a premature return.

## the\_cookie

```
attribute Cookie the_cookie;
```

This attribute specifies the cookie to be sent immediately following the invocation on a proxy's typed receiver. By default, the cookie is empty. A non-empty cookie can be used by `reply_recipient` to do more application-specific demultiplexing. See [“Cookie and reply de-multiplexing in reply recipients”](#) for more information.

## request\_tag

```
attribute RequestTag request_tag;
```

This attribute uniquely identifies the request immediately following an invocation on a proxy's typed receiver. By default the tag is initially empty, and it is reset to empty after sending the request. Requests with non-empty tags are involved in group polling. See [“poll\(\)”](#) and [“Group polling”](#).

### Note

- After each invocation, the Current `request_tag` attribute is automatically reset to empty or null.
- Attempting to initiate a 2PI on a proxy with a `request_tag` previously used by another 2PI on the proxy will result in a CORBA `BAD_INV_ORDER` exception with minor code `NativeMessaging::DUPLICATED_REQUEST_TAG`.

## the\_poller

```
readonly attribute object the_poller;
```

This attribute returns the poller object reference just after delivering a request through an invocation made on a proxy's typed receiver. Poller objects are used by client applications to fulfill the reply polling-pulling phase of two-phase invocations.

### Note

- A client application should call the same operation used in initiating the two-phase invocation on the given poller object to poll and retrieve the return result. Calling an operation on the poller that does not match the one used in initiating the two-phase invocation will result in a CORBA `BAD_OPERATION` exception, and the value of the Current `reply_not_available` attribute will be `TRUE`.
- Poller objects are normal CORBA objects with location transparency. Therefore, in Native Messaging, the request sending phase and the reply polling phase of a two-phase invocation are not necessarily carried out in same client execution context and through same transport connection. A client application can accomplish the first invocation phase and get the poller object, then perform the polling in a completely distinct client execution context, in a different process, and through a different transport connection.

- If an exception is raised in the reply polling-pulling phase, an application should use the Current `reply_not_available` attribute to determine whether the exception reports a reply polling-pulling failure or a successful reply pulling of a real exceptional result of the delegated request. `TRUE` indicates that this exception is a polling-pulling failure between the client and agent. `FALSE` indicates that this exception is the real result of the delegated request.
- Core operations made on poller objects are orthogonal to two-phase invocations pending on them. For instance, `_is_a()` or `_non_existent()` on a poller does not imply reply polling-pulling on the pending two-phase invocation, but only implies a repository ID comparison and non-existence check on the poller object itself.

## reply\_not\_available

readonly attribute boolean `reply_not_available`;

This attribute reports the consequence of an unblocked (either normal return or exception) call on a proxy's typed receiver, reply poller, or reply holder, as summarized by the following table.

Reply_not_available	True	False	True	False
Called object	Proxy's typed receiver	Reply poller or holder		
Normal return, no exception	2PI initiated (premature)	2PI completed	(poller only) Reply not available (premature)	2PI completed
RNA exception (unsuppressed mode)	2PI initiated (premature)	N/A	(poller only) Reply not available (premature)	N/A
Exception other than RNA	2PI initiation failure	2PI completed (target failure)	Polling-pulling failure	2PI completed (target failure)

The terms in the above table are defined as follows:

- **2PI initiated:** This is the result when an operation made on a proxy's typed receiver results in a normal return or an RNA exception (in unsuppressed mode), and the Current `reply_not_available` attribute is `TRUE`. This is one of the two premature return cases in Native Messaging. By default, a reply poller of this initiated two-phase invocation is available on Current after the call.
- **2PI initiation failure:** This is the result when an operation made on a proxy's typed receiver results in an exception other than RNA, and the Current `reply_not_available` attribute is `TRUE`. This outcome indicates either that the agent has rejected the two-phase invocation, or the client failed to receive agent's premature reply message. No reply poller is available on Current. If this is caused by a communication failure on receiving a premature reply message, the agent will still delegate the request and may even generate a callback to a reply recipient.
- **2PI completed:** This is the result when an operation made on a proxy's typed receiver, a reply poller or reply holder, results in either a normal return or any CORBA exception, and the Current `reply_not_available` attribute is `FALSE`. If the operation results in an exception other than RNA, a `TRUE` `reply_not_available` attribute indicates that this exception is a real result of a delegated request to target.
- **Reply not available:** This is the result when an operation made on a reply poller results in a normal return or an RNA exception, and the

Current `reply_not_available` attribute is `TRUE`. This is one of the two premature return cases.

- **Polling-Pulling failure:** This is the result when an operation made on a reply poller or reply holder results in an exception other than `RNA`, and the Current `reply_not_available` attribute is `TRUE`. This outcome indicates a usage or system failure on retrieving the reply, such as calling an unmatched operation or the poller has already been trashed.
- **N/A:** Not an applicable outcome. It should never happen.

## Interface ReplyRecipient

`ReplyRecipient` objects are implemented by Native Messaging applications to receive reply results in the callback model. See the example in [“Callback model”](#) and [“Cookie and reply de-multiplexing in reply recipients”](#).

### `reply_available()`

```
void
reply_available(
    in object reply_holder,
    in string operation,
    in Cookie the_cookie);
```

This method is callback by request agent on delivering a reply. The actual reply result, either a normal return or an exception, is held by the input `reply_holder` object and can be retrieved by making a callback on it. If an exception is raised from a call on the `reply_holder`, the application should use the Current `reply_not_available` attribute to determine whether the exception is reporting a retrieval failure or the real result of the delegated request. `TRUE` indicates that this exception is the result of a retrieval failure between the client and agent. `FALSE` indicates that this exception is a real result of the delegated request.

See the example in [“Callback model”](#).

Argument	Description
<code>reply_holder</code>	Within the scope of the <code>reply_available()</code> method, this object reference has the same semantics as a reply poller. A reply retrieving operation on <code>reply_holder</code> should only be made within the scope of the <code>reply_available()</code> method. Once the application returns from <code>reply_available()</code> , the <code>reply_holder</code> may no longer be valid.
<code>operation</code>	The original operation signature. It can be used by applications for coarse grained demultiplexing. A call made on the <code>reply_holder</code> reference should have same operation signature as this parameter. Making a call on the <code>reply_holder</code> with a different operation will end up with a <code>CORBA BAD_OPERATION</code> exception with Current <code>reply_not_available</code> attribute value of <code>TRUE</code> .
<code>the_cookie</code>	The original request cookie. Can be used by applications for fine grained demultiplexing.

## Semantics of core operations

Native Messaging reserves all pseudo operations as *core operations*. Core operations meet the following rules:

- They are always accomplished in one phase. Core operations always block until a mature return or a non-`RNA` exception.
- They do not initiate a two-phase invocation to be forwarded to the real target when called on a proxy's typed receiver. For instance, calling

`_non_existent()` on a proxy's typed receiver is only a ping to check the non-existence of the receiver itself, not the target.

- They are orthogonal to pending two-phase invocations on a reply poller or reply holder: For instance, calling `_is_a()` or `_non_existent()` on a reply poller or reply holder does not imply retrieving the reply result of the pending two-phase invocation, but only repository ID comparison and existence checks on these poller or holder objects themselves.

## Native Messaging Interoperability Specification

The content of this section is not intended for Native Messaging application developers but for third party Native Messaging vendors.

### Native Messaging uses native GIOP

In non-native messaging, such as CORBA Messaging, the OMG GIOP protocol is not used as a direct message protocol; it is used as a tunneling protocol for another ad hoc message routing protocol.

For instance, in CORBA Messaging, calling a mangled operation

```
sendc_foo(<input_parameter_list>);
```

does not incur a native OMG GIOP Request message with operation `sendc_foo` in the head and `<input_parameter_list>` as payload. Instead, a routing message tunneling through GIOP Request is sent.

Native Messaging uses the native OMG GIOP directly as its message level protocol:

- A method call on an agent, request proxy's typed receiver, reply poller, reply recipient, or reply holder reference incurs a native GIOP Request message with the exact called operation name in head, and the exact input parameters as payload to be sent, as defined by OMG GIOP.
- A premature return is simply a native GIOP Reply message containing an RNA exception, specifically a CORBA NO\_RESPONSE exception with minor code of REPLY\_NOT\_AVAILABLE.
- A mature return is simply a native GIOP Reply message with either the exact `<return_value_and_output_parameter_list>` or the exact exception from the target as payload.

### Native Messaging service context

Like the OMG Security and Transaction service, Native Messaging also uses a service context to achieve certain semantic results. The client-side Native Messaging engine, implemented in an OMG standardized PortableInterceptor for instance, is responsible for creating and adding required service contexts into certain outgoing requests and for extracting information from the same kind of service context inside incoming replies.

The `context_id` used by Native Messaging's service context is `NativeMessaging::NMService`. The `context_data` is an encapsulated `NativeMessaging::NMContextData` defined as:

```
module NativeMessaging {
    ...
    const IOP::ServiceID NMService = ...

    struct RequestInfo {
        RequestTag request_tag;
```

```

        Cookie the_cookie;
        unsigned long wait_timeout;
    };

    union NMContextData switch(short s) {
        case 0: RequestInfo req_info;
        case 1: unsigned long wait_timeout;
        case 2: object the_poller;
        case 3: string replier_name;
    };
};

```

Mandated usage of different context data in Native Messaging is summarized in the following table:

Sending to or receiving from	Proxy's typed receiver	Reply poller	Reply holder
Request	req_info	wait_timeout	Not defined
Normal Reply (NO_EXCEPTION)	Not defined		
RNA Exception	the_poller	No NMService context	N/A
Non-RNA exception from calling target	replier_name		
Non-RNA exception within agent	No NMService context		

The terms in the above table are defined as follows:

- **req\_info**: NMContextData is mandated to all requests of two-way non-core operation sending to a proxy's typed receiver. This context has `request_tag`, `cookie` and `wait_timeout` from Native Messaging Current as supplement parameters for initiating a two-phase invocation. The content of this context should be used by the request agent to tag the request, to deliver callback with the cookie, and to wait before evolving into a two-phased invocation. See corresponding topics in the previous sections.
- **wait\_timeout**: NMContextData is mandated to all normal (two-way non-core) requests sent to a reply poller, with `wait_timeout` from Native Messaging Current as supplement parameter for polling. The content, namely the `wait_timeout`, should be used by the request agent to block the call before a mature or premature return. See corresponding topics in previous sections.
- **the\_poller**: NMContextData is mandated to all successful returns on initiating two-phase invocations on a proxy's typed receiver object. The content of the context, a poller reference, is extracted and copied to Native Messaging Current's `the_poller` attribute.
- **replier\_name**: NMContextData is mandated to all exceptional returns as a successful return of an exceptional return result from delegating a request. This context should not appear if the exceptional return is a failure not resulting from delegating the request. The actual content of the string should be empty and preserved for further extension.
- **Not defined**: Native Messaging does not use NMService context in these cases.
- **N/A**: Not applicable. It should never happen.

## NativeMessaging tagged component

A tagged component with the `NativeMessaging::TAG_NM_REF` tag should be embedded in typed receivers of request proxies and poller references. The `component_data` of this tagged component encapsulates an octet. Namely the first octet of the `component_data` is the byte-order byte and second byte of it is the value octet. A value of `0x01` for this octet indicates the reference is a typed receiver of a request proxy, and a value of `0x02` indicates it is a poller reference.

This component is used by `PortableInterceptor`'s `send_request()` method to determine whether a request is sending to a Native Messaging request proxy's `the_receiver` reference, a reply poller, or something else, and to decide whether and what service context to add to the outgoing request.

## Using Native Messaging

### Using request agent and client model

#### Start the Request Agent

To start the Request Agent service, run the command `requestagent`. Run it with `requestagent -?` to see the usage information.

#### Request Agent URL

To use Native Messaging, a request agent needs to be known by client applications. Usually, this is done by initializing the client ORB with the OMG standardized ORB initialize command arguments:

```
-ORBInitRef RequestAgent=<request_agent_ior_or_url>
```

This allows client applications to resolve the request agent reference from the ORB as an initial service, for instance:

```
// Getting Request Agent reference in Java
org.omg.CORBA.Object ref
    = orb.resolve_initial_references("RequestAgent");
NativeMessaging.RequestAgentEx agent
    = NativeMessaging.RequestAgentExHelper.narrow(ref);
```

By default, the URL of a request agent is:

```
corbaloc::<host>:<port>/RequestAgent
```

Here, `<host>` is the host name or dotted IP address of a Request Agent server, and `<port>` is the TCP listener port number of this server. By default, the Native Messaging Request Agent uses port 5555.

### Using the Native Messaging client model

Native Messaging client side models in Java are implemented as OMG portable interceptors and are referred to as the Native Messaging Client Component. The Native Messaging for Java Client Component needs to be initialized explicitly by setting `vbroker.orb.enableNativeMessaging` to `true` (the default value is `false`).

## Request Agent vbroker properties

### **vbroker.requestagent.maxThreads**

Specifies the maximum number of threads for request invocation. The default value is 0 (zero) which means no limit. Values cannot be negative.

### **vbroker.requestagent.maxOutstandingRequests**

Specifies the maximum queue size for requests waiting to get serviced. This property only takes effect if the `maxThreads` property is set to non-zero value. The default value is 0 (zero) which means no limit. Values cannot be negative. If a request arrives when the queue size is equal to maximum size, the request waits for a timeout until there is space in the queue. See [“vbroker.requestagent.blockingTimeout”](#).

### **vbroker.requestagent.blockingTimeout**

Specifies the maximum time, in milliseconds, that a request can wait before it is added to the queue. The default value is 0 (zero) which means no wait. Values cannot be negative. If the value is set to 0 (zero) and a request arrives and the queue is full, the Request Agent will raise `CORBA : : IMP_LIMIT` exception. Otherwise, the request waits for the specified timeout. After the timeout, either the request gets executed immediately if the queue is empty and worker thread is available, or the request is enqueued in the waiting queue if the queue has space and the request remains there until it gets serviced, or if the queue is still full, `CORBA : : IMP_LIMIT` exception is raised by the Request Agent.

### **vbroker.requestagent.router.ior**

Specifies the IOR of OMG messaging router. The default value is empty string.

### **vbroker.requestagent.listener.port**

Specifies the TCP listener port to be used by the request agent. The default value is 5555.

### **vbroker.requestagent.requestTimeout**

This property specifies the maximum time, in milliseconds, that the agent will hold the reply result for its client. If request agent has received reply results on a request, but the client does not pull the result or trash the request, the request agent will trash the request (together with its reply result) upon the expiration of the request timeout set by this property. The default value of this property is infinity, meaning the agent will preserve the reply results until they are trashed by client applications (manually or automatically).

## Interoperability with CORBA Messaging

The Native Messaging Request Agent is forward interoperable with the OMG untyped Messaging Router. Specifically, the Request Agent can be configured to route requests through an OMG untyped router instead of sending them directly to their specified targets. To do so, the request agent needs to be started with the [“vbroker.requestagent.router.ior”](#) property with a valid CORBA Messaging router IOR as value.



# Using the Object Activation Daemon (OAD)

This section discusses how to use the Object Activation Daemon (OAD).

## Automatic activation of objects and servers

The Object Activation Daemon (OAD) is the VisiBroker implementation of the Implementation Repository. The Implementation Repository provides a runtime repository of information about the classes a server supports, the objects that are instantiated, and their IDs. In addition to the services provided by a typical Implementation Repository, the OAD is used to automatically activate an implementation when a client references the object. You can register an object implementation with the OAD to provide this automatic activation behavior for your objects.

Object implementations can be registered using a command-line interface (`oadutil`). There is also a VisiBroker ORB interface to the OAD, described in [“IDL interface to the OAD”](#). In each case, the repository ID, object name, the activation policy, and the executable program representing the implementation must be specified.

### Note

You can use the VisiBroker OAD to instantiate servers generated with VisiBroker for Java and C++.

The OAD is a separate process that only needs to be started on those hosts where object servers are to be activated on demand.

## Locating the Implementation Repository data

Activation information for all object implementations registered with the OAD are stored in the Implementation Repository. By default, the Implementation Repository data is stored in a file named `impl_rep` in the `<install_dir>/adm/impl_dir` directory.

## Activating servers

The OAD activates servers in response to client requests. VisiBroker clients and non-VisiBroker IIOP-compliant clients can activate servers through the OAD.

Any client that uses the IIOP protocol can activate a VisiBroker server when that server's reference is used. The server's exported Object Reference points to the OAD and the client can be forwarded to the spawned server in accordance with the rules of IIOP. To allow true persistence of the server's object references (such as through a Name Service), the OAD must always be started on the same port. For example, to start the OAD on port 16050, enter the following:

```
prompt> oad -VBJprop  
vbroker.se.iiop_tp.scm.iiop_tp.listener.port=16050
```

**Note**

Port 16000 is the default port, but it can be changed by setting the `listener.port` property.

## Using the OAD

The OAD is an optional feature that allows you to register objects that are to be started automatically when clients attempt to access them. Before starting the OAD, you should first start the Smart Agent. For more information, see [“Starting a Smart Agent \(osagent\)”](#).

### Starting the OAD

#### Windows

To start the OAD:

- Use the `oad.exe` located in `<install_dir>\bin\`  
or

- Enter the following at the command prompt:

```
prompt> oad
```

or

- In Console mode, enter the following at the command prompt:

```
prompt> oad -C
```

The `oad` command accepts the following command line arguments:

Option	Description
<code>-verbose</code>	Turns on verbose mode.
<code>-version</code>	Prints the version of this tool.
<code>-path &lt;path&gt;</code>	Specifies the platform-specific directory for storing the Implementation Repository. This overrides any setting provided through the use of environment variables.
<code>-filename &lt;repository_filename&gt;</code>	Specifies the name of the Implementation Repository. If you do not specify it, the default is <code>impl_rep</code> . This overrides any user environment variable settings.
<code>-timeout &lt;#_of_seconds&gt;</code>	Specifies the amount of time the OAD will wait for a spawned server process to activate the requested VisiBroker ORB object. The default time-out is 20 seconds. Set this value to 0 (zero) if you wish to wait indefinitely. If a spawned server process does not activate the requested object within the time-out interval, the OAD will kill the spawned process and the client will see a <code>CORBA::NO_IMPLEMENT</code> exception. Turn on the verbose option to see more detailed information.
<code>-IOR &lt;IOR_filename&gt;</code>	Specifies the filename to store the OAD's stringified IOR.
<code>-kill</code>	Stipulates that an object's child process should be killed once all of its object are unregistered with the OAD.
<code>-no_verify</code>	Turns off check for validity of registrations.

Option	Description
-?	Displays command usage.
-readonly	When the OAD is started with the <code>-readonly</code> option, no changes can be made to the registered objects. Attempts to register or unregister objects will return an error. The <code>-readonly</code> option is usually used after you've made changes to the Implementation Repository, and have restarted the OAD in <code>readonly</code> mode to prevent any additional changes.

The OAD is installed as Windows Service, allowing you to control it with the Service Manager provided with Windows.

## UNIX

To start the OAD enter the following command:

```
prompt> oad &
```

## Using the OAD utilities

The `oadutil` commands provide a way for you to manually register, unregister, and list the object implementations available on your VisiBroker system. The `oadutil` commands are implemented in Java and use a command line interface. Each command is accessed by invoking the `oadutil` command, passing the type of operation to be performed as the first argument.

### Note

An object activation daemon process (`oad`) must be started on at least one host in your network before you can use the `oadutil` commands.

The `oadutil` command has the following syntax:

```
oadutil {list|reg|unreg} [options]
```

The options for this tool vary, depending on whether you specify `list`, `reg` or `unreg`.

## Converting interface names to repository IDs

Interface names and repository IDs are two ways of representing the type of interface the activated object should implement. All interfaces defined in IDL are assigned a unique repository identifier. This string is used to identify a type when communicating with the Interface Repository, the OAD, and most calls to the VisiBroker ORB itself.

When registering or unregistering an object with the OAD, the `oadutil` commands allow you to specify either an object's IDL interface name or its repository id.

An interface name is converted to a repository ID as follows:

- 1 Prepend "IDL:" to the interface name.
- 2 Replace all non-leading instances of the scope resolution operator (`::`) with a slash (`/`) character.
- 3 Append `":1.0"` to the interface name.

For example, the IDL interface name

```
::Module1::Module2::IntfName
```

would be converted to the following repository ID:

```
IDL:Module1/Module2/IntfName:1.0
```

The `#pragma ID` and `#pragma prefix` mechanisms can be used to override the default generation of repository ID's from interface names. If the `#pragma ID` mechanism is used in user-defined IDL files to specify non-standard repository IDs, the conversion process outlined above will not work. In these cases, you must use `-r` repository ID argument and specify the object's repository ID.

To obtain the repository id of the object implementation's most derived interface in Java, use the method `java: <interface_name>Helper.id()` defined for all CORBA objects.

## Listing objects with oadutil list

The `oadutil list` utility allows you to list all VisiBroker ORB object implementations registered with the OAD. The information for each object includes:

- Interface names of the VisiBroker ORB objects.
- Instance names of the object offered by that implementation.
- Full path name of the server implementation's executable.
- Activation policy of the VisiBroker ORB object (shared or unshared).
- Reference data specified when the implementation was registered with the OAD.
- List of arguments to be passed to the server at activation time.
- List of environment variables to be passed to the server at activation time.

The `oadutil list` command returns all VisiBroker ORB object implementations registered with the OAD. Each OAD has its own Implementation Repository database where the registration information is stored.

### Note

An OAD process must be started on at least one host in your network before you can use the `oadutil list` command.

The `oadutil list` command has the following syntax:

```
oadutil list [options]
```

The `oadutil list` command accepts the following command line arguments:

Option	Description
<code>-i &lt;interface name&gt;</code>	Lists the implementation information for objects of a particular IDL interface name. Only one of the following options may be specified at a particular time: <code>-i</code> , <code>-r</code> , <code>-s</code> , or <code>-poa</code> .  <b>Note:</b> All communications with the VisiBroker ORB reference an object's repository id instead of the interface name. For more information about the conversion performed when specifying an interface name, see the <a href="#">"Converting interface names to repository IDs"</a> section.
<code>-r &lt;repository id&gt;</code>	Lists the implementation information of a specific repository id. See <a href="#">"Converting interface names to repository IDs"</a> for details on specifying repository IDs. Only one of the following options may be specified at a particular time: <code>-i</code> , <code>-r</code> , <code>-s</code> , or <code>-poa</code> .

Option	Description
-s <service name>	Lists the implementation information for a specific service name. Only one of the following options may be specified at a particular time: -i, -r, -s, or -poa.
-poa <poa_name>	Lists the implementation information for a specific POA name. Only one of the following options may be specified at a particular time: -i, -r, -s, or -poa.
-o <object name>	Lists the implementation information for a specific object name. You can use this only if the interface or repository id is specified in the command statement. This option is not applicable when an -s or -poa arguments is used.
-h <OAD host name>	Lists the implementation information for objects registered with an OAD running on a specific remote host.
-verbose	Turns verbose mode on, causing messages to be output to stdout.
-version	Prints the version of this tool.
-full	Lists the status of all implementations registered with the OAD.

The following is an example of a local list request, specifying an interface name and object name:

```
oadutil list -i Bank::AccountManager -o MFBank
```

The following is an example of a remote list request, specifying a host IP address:

```
oadutil list -h 206.64.15.198
```

## Registering objects with oadutil

The `oadutil` command can be used to register an object implementation from the command line or from within a script. The parameters are either the interface name and object name, the service name, or the POA name, and path name to the executable that starts the implementation. If the activation policy is not specified, the shared server policy will be used by default. You may write an implementation and start it manually during the development and testing phases. When your implementation is ready to be deployed, you can simply use `oadutil` to register your implementation with the OAD.

### Notes

- When registering an object implementation, use the same object name that is used when the implementation object is constructed. Only named objects (those with a global scope) may be registered with the OAD.
- An `oad` process must be started on at least one host in your network before you can use the `oadutil reg` command.

The `oadutil reg` command has the following syntax:

```
oadutil reg [options]
```

The `oadutil reg` command accepts the following command-line arguments:

Option	Required	Description
<code>-i &lt;interface name&gt;</code>	Yes	Specifies a particular IDL interface name. Only one of the following options may be specified at a particular time: <code>-i</code> , <code>-r</code> , <code>-s</code> , or <code>-poa</code> . See <a href="#">"Converting interface names to repository IDs"</a> for details on specifying repository IDs.
<code>-r &lt;repository id&gt;</code>	Yes	Specifies a particular repository id. Only one of the following options may be specified at a particular time: <code>-i</code> , <code>-r</code> , <code>-s</code> , or <code>-poa</code> .
<code>-s &lt;service name&gt;</code>	Yes	Specifies a particular service name. Only one of the following options may be specified at a particular time: <code>-i</code> , <code>-r</code> , <code>-s</code> , or <code>-poa</code> .
<code>-poa &lt;poa_name&gt;</code>	Yes	Use this option to register the POA instead of an object implementation. Only one of the following options may be specified at a particular time: <code>-i</code> , <code>-r</code> , <code>-s</code> , or <code>-poa</code> .
<code>-o &lt;object name&gt;</code>	Yes	Specifies a particular object. You can use this only if the interface name or repository id is specified in the command statement. This option is not applicable when an <code>-s</code> or <code>-poa</code> argument is used.
<code>-cpp &lt;file name to execute&gt;</code>	Yes	Specifies the full path of an executable file that must create and register an object that matches the <code>-o/-r/-s/-poa</code> arguments. Applications registered with the <code>-cpp</code> argument must be stand-alone executables.
<code>-java &lt;full class name&gt;</code>	Yes	Specifies the full name of a Java class containing a main routine. This application must create and register an Object that matches the <code>-o/-r/-s/-poa</code> argument. Classes registered with the <code>-java</code> argument will be executed with the command <code>vbj &lt;full_classname&gt;</code> .
<code>-host &lt;OAD host name&gt;</code>	No	Specifies a specific remote host where the OAD is running.
<code>-verbose</code>	No	Turns verbose mode on, causing messages to be output to stdout.
<code>-version</code>	No	Prints the version of this tool.
<code>-cos_name &lt;CosName&gt;</code>	No	Specifies the CosName to bind this registration to. NOTE: This does not work with service or POA registrations.
<code>-d &lt;referenceData&gt;</code>	No	Specifies reference data to be passed to the server upon activation.
<code>-a arg1 -a arg2</code>	No	Specifies the arguments to be passed to the spawned executable as command-line arguments. Arguments can be passed with multiple <code>-a (arg)</code> parameters. They will be propagated in order to create the spawned executable.
<code>-e env1 -e env2</code>	No	Specifies environment variables to be passed to the spawned executable. Arguments can be passed with multiple <code>-e (env)</code> parameters. They will be propagated in order to create the spawned executable.
<code>-p &lt;shared unshared&gt;</code>	No	Specifies the activation policy of the spawned objects. The default policy is <code>SHARED_SERVER</code> . <b>Shared:</b> Multiple clients of a given object share the same implementation. Only one server is activated by an OAD at a particular time. <b>Unshared:</b> Only one client of a given implementation will bind to the activated server. If multiple clients wish to bind to the same object implementation, a separate server is activated for each client application. A server exits when its client application disconnects or exits.

## Example: Registering a POA

The following command registers a POA with the OAD.

```
oadutil reg -e vbroker.oad.locateAlways=true -poa /
bank_agent_poa -java Server -verbose -p unshared
```

Specifying `vbroker.oad.locateAlways` as `true` ensures that the client can locate the POA; see [“OAD properties”](#) for details of this property. The instance name is `/bank_agent_poa`. The object has the `unshared` policy, by which it will be terminated when the requesting client breaks its connection to the spawned server.

### Example: Specifying repository ID

The following command will register with the OAD the `VisiBroker` program `factory`. It will be activated upon request for objects of repository ID `IDL:ehTest/Factory:1.0` (which corresponds to the interface name `ehTest::Factory`). The instance name of the object to be activated is `ReentrantServer`, and that name is also passed to the spawned executable as a command-line argument. This server has the `unshared` policy, by which it will be terminated when the requesting client breaks its connection to the spawned server.

```
prompt> oadutil reg -e vbroker.oad.locateAlways=true -r
IDL:ehTest/Factory:1.0
-o ReentrantServer -java factory_r -a ReentrantServer -p
unshared
```

#### Note

In the example above, the specified Java class must be found in the `CLASSPATH`.

### Example: Specifying IDL interface name

The following command will register the `VisiBroker` `Server` class with the OAD. In this example, the specified class must activate an object of repository ID `IDL:Bank/AccountManager:1.0` (corresponding to the interface name IDL name `Bank::AccountManager`) and instance name `CreditUnion`. The server will be started with `unshared` policy, ensuring that it will terminate when the requesting client breaks its connection. The server is also passed with an environment variable `DEBUG=1` when it is first started by the client.

```
prompt> oadutil reg -i Bank::AccountManager -o CreditUnion
-java Server
-a CreditUnion -p unshared -e DEBUG=1 -e
vbroker.oad.locateAlways=true
```

#### Note

In the previous example, the specified Java class must be found in the `CLASSPATH`.

The previous registration tells the OAD to execute the following command when spawning the requested server:

```
vbj -DDEBUG=1 Server CreditUnion
```

### Remote registration to an OAD

To register an implementation with an OAD on a remote host, use the `-h` argument to `oadutil reg`.

The following is an example of how to perform a remote registration to an OAD on Windows from a UNIX shell. The double backslashes are necessary to avoid having the shell interpret the backslashes before passing them to `oadutil`.

```
prompt> oadutil reg -r IDL:Library:1.0 Harvard \
  -java c:\\vbroker\\examples\\library\\libsrv -p shared -h
  100.64.15.198
```

## Using the OAD without using the Smart Agent

To access a server using the OAD without involving the Smart Agent, use the property `vbroker.orb.activationIOR` to indicate the OAD's IOR to `oadutil` and to the server.

For example, let us assume that the OAD's IOR is located in the `e:/adm` dir (on Windows), and you want to run the `bank_portable` example that is included (in the `examples/basic/bank_portable` directory) with with the product. To access this server without using the Smart Agent:

- 1 Start the OAD:** the classpath visible to OAD must include the Server's classpath. The command is:

```
prompt>start oad -VBJprop
vbroker.agent.enableLocator=false -verbose
```

- 2 Register the server using `oadutil`:** the command is:

```
prompt> oadutil -VBJprop vbroker.orb.activationIOR=file:
  ///e:/adm/oadj.ior -VBJprop
  vbroker.agent.enableLocator=false reg -i
  Bank::AccountManager
  -o BankManager -java Server
```

- 3 Generate the Server's IOR:** when the server is started it will write out it's IOR into a file. Terminate the server once it is running, so that the launching of the server by the OAD can be demonstrated. The command is:

```
prompt> vbj -Dvbroker.orb.activationIOR=file:///e:/adm/
  oadj.ior Server
```

- 4 Run the Client:** make sure the OAD is running, then use the command:

```
prompt> vbj -Dvbroker.agent.enableLocator=false Client
```

## Using the OAD with the Naming Service

OAD facilitates the use of the Naming Service for bootstrapping. In the above section, the Smart Agent was not used, and the client needed to obtain the server's IOR file. This bootstrapping can be achieved using the Naming Service instead, as illustrated in the following steps.

- 1 Start the OAD,** providing it with a reference to the Naming Service. Assume that the Naming Service runs on port 1111 on host `myhost`.

```
prompt>oad -verbose -VBJprop
vbroker.orb.initRef=NameService=corbaloc::myhost:1111/
NameService
```

- 2 Register the server with the OAD.** Note the use of the `-cos_name` parameter which indicates to the OAD that this server should be automatically bound to the Naming Service.

```
prompt>oadutil -VBJprop vbroker.orb.activationIOR=file:
  ///e:/adm/oadj.ior -VBJprop
  vbroker.agent.enableLocator=false reg -i
  Bank::AccountManager
  -o BankManager -cos_name simple_test -cpp Server/pre>
prompt>oadutil -VBJprop vbroker.orb.activationIOR=file:
  ///e:/adm/oadj.ior -VBJprop
  vbroker.agent.enableLocator=false reg -i
```



```
Bank::AccountManager
-o BankManager -cos_name simple_test -java Server
-e vbroker.oad.locateAlways=true
```

- 3 The client can then use the Naming Service to resolve and obtain the server's reference. A snippet of the client code for a Java client is shown below.

```
prompt>org.omg.CORBA.Object server=
        rootCtx.resolve(new NameComponent [] {new
NameComponent("simple_test","")});
```

Note that the OAD automatically created a binding for the server in the Naming Service because the `-cos_name` parameter was used.

## Distinguishing between multiple instances of an object

Your implementation can use `ReferenceData` to distinguish between multiple instances of the same object. The value of the reference data is chosen by the implementation at object creation time and remains constant during the lifetime of the object. The `ReferenceData` typedef is portable across platforms and VisiBroker ORBs.

## Setting activation properties using the `CreationImplDef` class

The `CreationImplDef` class contains the properties the OAD requires to activate a VisiBroker ORB object: `path_name`, `activation_policy`, `args`, and `env`. The following sample shows the `CreationImplDef` struct.

The `path_name` property specifies the exact path name of the executable program that implements the object. The `activation_policy` property represents the server's activation policy, discussed in [“Example of object creation and registration”](#). The `args` and `env` properties represent command line arguments and environment settings for the server.

```
module extension {
...
enum Policy {
    SHARED_SERVER,
    UNSHARED_SERVER
};
struct CreationImplDef {
    CORBA::RepositoryId repository_id;
    string                object_name;
    CORBA::ReferenceData  id;
    string                path_name;
    Policy                activation_policy;
    CORBA::StringSequence args;
    CORBA::StringSequence env;
};
...
};
```

## Dynamically changing an ORB implementation

The sample below shows the `change_implementation()` method which can be used to dynamically change an object's registration. You can use this

method to change the object's activation policy, path name, arguments, and environment variables.

```

module Activation
{
...
void change_implementation(in
extension::CreationImplDef old_info,
in extension::CreationImplDef new_info)
raises ( NotRegistered, InvalidPath, IsActive );
...
};

```

### Caution

Although you can change an object's implementation name and object name with the `change_implementation()` method, you should exercise caution. Doing so will prevent client programs from locating the object with the old name.

## OAD Registration using OAD::reg\_implementation

Instead of using the `oadutil reg` command manually or in a script, VisiBroker allows client applications to use the `OAD::reg_implementation` operation to register one or more objects with the activation daemon. Using this operation results in an object implementation being registered with the OAD and the `osagent`. The OAD will store the information in the Implementation Repository, allowing the object implementation to be located and activated when a client attempts to bind to the object.

```

module Activation {
...
typedef sequence<ObjectStatus> ObjectStatus List;
...
typedef sequence<ImplementationStatus> ImplStatusList;
...
interface OAD {
// Register an implementation.
Object reg_implementation(in
extension::CreationImplDef impl)
raises (DuplicateEntry, InvalidPath);
}
}

```

The `CreationImplDef` struct contains the properties the OAD requires. The properties are `repository_id`, `object_name`, `id`, `path_name`, `activation_policy`, `args`, and `env`. Operations for setting and querying their values are also provided. These additional properties are used by the OAD to activate an VisiBroker ORB object.

```

struct CreationImplDef {
CORBA::RepositoryId repository_id;
string object_name;
CORBA::ReferenceData id;
string path_name;
Policy activation_policy;
CORBA::StringSequence args;
CORBA::StringSequence env;
};

```

The `path_name` property specifies the exact path name of the executable program that implements the object. The `activation_policy` property represents the server's activation policy. The `args` and `env` properties represent optional arguments and environment settings to be passed to the server.

## Example of object creation and registration

The following code sample shows how to use the `CreationImplDef` class and the `OAD.reg_implementation()` method to register a server with the OAD. This mechanism may be used in a separate, administrative program, not necessarily in the object implementation itself. If used in the object implementation, these tasks must be performed prior to activating the object implementation.

Creating an ORB object and registering with the OAD:

```
// Register.java
import com.inprise.vbroker.Activation.*;
import com.inprise.vbroker.extension.*;
public class Register{
    public static void main(String[] args) {
        // Initialize the ORB.
        org.omg.CORBA.ORB orb =
org.omg.CORBA.ORB.init(args,null);
        // Locate an OAD
        try {
            OAD anOAD =
                OADHelper.bind(orb);
            // Create an ImplDef
            CreationImplDef _implDef = new

com.inprise.vbroker.extension.CreationImplDef();
            _implDef.repository_id = "IDL:Bank/
AccountManager:1.0";
            _implDef.object_name = "BankManager";
            _implDef.path_name = "vbj";
            _implDef.id = new byte[0];
            _implDef.activation_policy =

com.inprise.vbroker.extension.Policy.SHARED_SERVER;
            _implDef.env = new String[1];
            _implDef.env[0] =
"vbroker.oad.locateAlways=true";
            String[] str = new String[1];
            str[0] = "Server";
            _implDef.args = str;
            try {
                anOAD.reg_implementation(_implDef);
            } catch (Exception e) {
                System.out.println("Caught " + e);
            }
        }
        catch (org.omg.CORBA.NO_IMPLEMENT e) {
        }
    }
}
```

## Arguments passed by the OAD

When the OAD starts an object implementation it passes all of the arguments that were specified when the implementation was registered with the OAD.

## Un-registering objects

When the services offered by an object are no longer available or temporarily suspended, the object should be unregistered with the OAD. When the VisiBroker ORB object is unregistered, it is removed from the Implementation Repository. The object is also removed from the Smart Agent's dictionary. Once an object is unregistered, client programs will no longer be able to locate or use it. In addition, you will be unable to use the `OAD.change_implementation()` method to change the object's implementation. As with the registration process, un-registering may be done either at the command line or programmatically.

## Un-registering objects using the oadutil tool

The `oadutil unreg` command allows you to unregister one or more object implementations registered with the OAD. Once an object is unregistered, it can no longer be automatically activated by the OAD if a client requests the object. Only objects that have been previously registered via the `oadutil reg` command may be unregistered with `oadutil unreg`.

If you specify only an interface name, all VisiBroker ORB objects associated with that interface will be unregistered. Alternatively, you may identify a specific VisiBroker ORB object by its interface name and object name. When you unregister an object, all processes associated with that object will be terminated.

### Note

An `oad` process must be started on at least one host in your network before you can use the `oadutil reg` command.

The `oadutil unreg` command has the following syntax:

```
oadutil unreg [options]
```

The options for the `oadutil unreg` command accepts the following command line arguments:

Option	Required	Description
<code>-i &lt;interface name&gt;</code>	Yes	Specifies a particular IDL interface name. Only one of the following options may be specified at a particular time: <code>-i</code> , <code>-r</code> , <code>-s</code> , or <code>-poa</code> . See <a href="#">"Converting interface names to repository IDs"</a> for details on specifying repository IDs.
<code>-r &lt;repository id&gt;</code>	Yes	Specifies a particular repository id. Only one of the following options may be specified at a particular time: <code>-i</code> , <code>-r</code> , <code>-s</code> , or <code>-poa</code> .
<code>-s &lt;service name&gt;</code>	Yes	Specifies a particular service name. Only one of the following options may be specified at a particular time: <code>-i</code> , <code>-r</code> , <code>-s</code> , or <code>-poa</code> .
<code>-o &lt;object name&gt;</code>	Yes	Specifies a particular object name. You can use this only if the interface name or repository id is included in the command statement. This option is not applicable when a <code>-s</code> or <code>-poa</code> argument is used.
<code>-poa &lt;POA_name&gt;</code>	Yes	Unregisters the POA registered using <code>oadutil reg -poa &lt;POA_name&gt;</code> .

Option	Required	Description
-host <host name>	No	Specifies the host name where the OAD is running.
-verbose	No	Enables verbose mode, causing messages to be output to stdout.
-version	No	Prints the version of this tool.

## Unregistration example

The `oadutil unreg` utility unregisters one or more VisiBroker ORB objects from these three locations:

- Object Activation Daemon
- Implementation repository
- Smart Agent

The following is an example of how to use the `oadutil unreg` command. It unregisters the implementation of the `Bank::AccountManager` named `MyBank` from the local OAD.

```
oadutil unreg -i Bank::AccountManager -o MyBank
```

## Unregistering with the OAD operations

An object's implementation can use any one of the operations or attributes in the OAD interface to unregister a VisiBroker ORB object.

- `unreg_implementation(in CORBA::RepositoryId repId, in string object_name)`
- `unreg_interface(in CORBA::RepositoryId repId)`
- `unregister_all()`
- attribute `boolean destroy_on_unregister()`

Operation	Description
<code>unreg_implementation()</code>	Use this operation when you want to un-registered implementations using a specific repository id and object name. This operation terminates all processes currently implementing the specified repository id and object name.
<code>unreg_interface()</code>	Use this operation when you want to un-registered implementations by using a specific repository id only. This operation terminates all processes currently implementing the specified repository id.
<code>unregister_all()</code>	Use this operation to un-registered all implementations. Unless <code>destroyActive</code> is set to <code>true</code> , all active implementations continue to execute. For backward compatibility, <code>unregister_all()</code> is <b>not</b> destructive; it is equivalent to invoking <code>unregister_all_destroy(false)</code> .
<code>destroy_on_unregister</code>	Use this attribute to destroy any spawned processes on unregistration of the relevant implementation. The default value is <code>false</code> .

The following is an example of an OAD unregistered operation:

```
module Activation {
    ...
    interface OAD {
        ...
        void unreg_implementation(in CORBA::RepositoryId
            repId,
            in string object_name)
```

```

        raises (NotRegistered);
        ...
    }
}

```

## Displaying the contents of the Implementation Repository

You can use the `oadutil` tool to list the contents of a particular Implementation Repository. For each implementation in the repository the `oadutil` tool lists all the object instance names, the path name of the executable program, the activation mode and the reference data. Any arguments or environment variables that are to be passed to the executable program are also listed.

## IDL interface to the OAD

The OAD is implemented as a VisiBroker ORB object, allowing you to create a client program that binds to the OAD and uses its interface to query the status of objects that have been registered. The sample below shows the IDL interface specification for the OAD.

```

module Activation
{
    enum state {
        ACTIVE,
        INACTIVE,
        WAITING_FOR_ACTIVATION
    };
    struct ObjectStatus {
        long unique_id;
        State activation_state;
        Object objRef;
    };
    typedef sequence<ObjectStatus> ObjectStatusList;
    struct ImplementationStatus {
        extension::CreationImplDef impl;
        ObjectStatusList status;
    };
    typedef sequence<ImplementationStatus> ImplStatusList;
    exception DuplicateEntry {};
    exception InvalidPath {};
    exception NotRegistered {};
    exception FailedToExecute {};
    exception NotResponding {};
    exception IsActive {};
    exception Busy {};
    interface OAD {
        Object reg_implementation( in
extension::CreationImplDef impl)
            raises (DuplicateEntry, InvalidPath);
        extension::CreationImplDef get_implementation(
            in CORBA::RepositoryId repId,
            in string object_name)
            raises ( NotRegistered);
        void change_implementation(in
extension::CreationImplDef old_info,
            in extension::CreationImplDef new_info)
    };
};

```

```

        raises
(NotRegistered, InvalidPath, IsActive);
    attribute boolean destroy_on_unregister;
    void unreg_implementation(in CORBA::RepositoryId
repId,
        in string object_name)
        raises ( NotRegistered );
    void unreg_interface(in CORBA::RepositoryId repId)
        raises ( NotRegistered );
    void unregister_all();
    ImplementationStatus get_status(in
CORBA::RepositoryId repId,
        in string object_name)
        raises ( NotRegistered);
    ImplStatusList get_status_interface(in
CORBA::RepositoryId repId)
        raises
(NotRegistered);
    ImplStatusList get_status_all();
};

```





# Using Interface Repositories

An Interface Repository (IR) contains descriptions of CORBA object interfaces. The data in an IR is the same as in IDL files, descriptions of modules, interfaces, operations, and parameters, but it is organized for runtime access by clients. A client can browse an Interface Repository (perhaps serving as an online reference tool for developers) or can look up the interface of any object for which it has a reference (perhaps in preparation for invoking the object with the Dynamic Invocation Interface (DII)).

Reading this section will enable you to create an Interface Repository and access it with VisiBroker utilities or with your own code.

## What is an Interface Repository?

An Interface Repository (IR) is like a database of CORBA object interface information that enables clients to learn about or update interface descriptions at runtime. In contrast to the VisiBroker Location Service, described in [“Using the Location Service”](#) which holds data describing object *instances*, an IR's data describes *interfaces* (types). There may or may not be available instances that satisfy the interfaces stored in an IR. The information in an IR is equivalent to the information in an IDL file (or files), but it is represented in a way that is easier for clients to use at runtime.

Clients that use Interface Repositories may also use the Dynamic Invocation Interface (DII) described in [“Using the Dynamic Invocation Interface”](#). Such clients use an Interface Repository to learn about an unknown object's interface, and they use the DII to invoke methods on the object. However, there is no necessary connection between an IR and the DII. For example, someone could use the IR to write an “IDL browser” tool for developers; in such a tool, dragging a method description from the browser to an editor would insert a template method invocation into the developer's source code. In this example, the IR is used without the DII.

You create an Interface Repository with the VisiBroker `irep` program, which is the IR server (implementation). You can update or populate an Interface Repository with the VisiBroker `idl2ir` program, or you can write your own IR client that inspects an Interface Repository, updates it, or does both.

## What does an Interface Repository contain?

An Interface Repository contains hierarchies of objects whose methods divulge information about interfaces. Although interfaces are usually thought of as describing objects, using a collection of objects to describe interfaces makes sense in a CORBA environment because it requires no new mechanism such as a database.

As an example of the kinds of objects an IR can contain, consider that IDL files can contain IDL module definitions, and modules can contain interface definitions, and interfaces can contain operation (method) definitions. Correspondingly, an Interface Repository can contain `ModuleDef` objects which can contain `InterfaceDef` objects, which can contain `OperationDef` objects. Thus, from an IR `ModuleDef`, you can learn what `InterfaceDefs` it contains. The reverse is also true; given an `InterfaceDef` you can learn what `ModuleDef` it is contained in. All other IDL constructs, including exceptions, attributes, and valuetypes, can be represented in an Interface Repository.

An Interface Repository also contains typecodes. Typecodes are not explicitly listed in IDL files, but are automatically derived from the types (long, string, struct, and so on) that are defined or mentioned in IDL files. Typecodes are used to encode and decode instances of the CORBA any type: a generic type that stands for any type and is used with the dynamic invocation interface.

## How many Interface Repositories can you have?

Interface repositories are like other objects; you can create as many as you like. There is no VisiBroker-mandated policy governing the creation or use of IRs. You determine how Interface Repositories are deployed and named at your site. You may, for example, adopt the convention that a central Interface Repository contains the interfaces of all “production” objects, and developers create their own IRs for testing.

### Note

Interface repositories are writable and are not protected by access controls. An erroneous or malicious client can corrupt an IR or obtain sensitive information from it.

If you want to use the `_get_interface_def` method defined for all objects, you must have at least one Interface Repository server running so the VisiBroker ORB can look up the interface in the IR. If no Interface Repository is available, or if the IR that the VisiBroker ORB binds to has not been loaded with an interface definition for the object, `_get_interface_def` raises a `NO_IMPLEMENT` exception.

## Creating and viewing an Interface Repository with irep

The VisiBroker Interface Repository server is called `irep`, and is located in the `<install_dir>/bin` directory. The `irep` program runs as a daemon. You can register `irep` with the Object Activation Daemon (OAD) as you would any object implementation. The `oadutil` tool requires the object ID, for example, `IDL:org.omg/CORBA/Repository:2.3` (as opposed to an interface name such as `CORBA::Repository`).

### Note

The `irep` server needs a rollback file to keep its internal data consistent. The file is created if it does not already exist, for example when launching the `irep` server for the first time. The `IRepName` specified in the command line is used to make up the name of the rollback file. Make sure that the name contains only valid file system characters based on your platform. If the specified name contains directory locations that do not exist, they will be automatically created.

## Creating an Interface Repository with irep

Use the `irep` program to create an Interface Repository and view its contents. The usage syntax for the `irep` program is as follows:

```
irep <driver_options> <other_options> <IRepName>
[file.idl]
```

The syntax for creating an Interface Repository in the `irep` is described in the following table:

Syntax	Description
IRepName	Specifies the instance name of the Interface Repository. Clients can bind to this Interface Repository instance by specifying this name.
file.idl	Specifies the IDL file whose contents <code>irep</code> will load into the Interface Repository it creates and will store the IR contents into when it exits. If no file is specified, <code>irep</code> creates an empty Interface Repository.

The `irep` arguments are defined in the following table. You may also use the driver options defined in [“General options”](#).

Argument	Description
-D, -define foo[=bar]	Define a preprocessor macro, optionally with value.
-I, -include <dir>	Specify additional directory for <code>#include</code> searching.
-P, -no_line_directives	Do not emit <code>#line</code> directives from preprocessor. The default is <code>off</code> .
-H, -list_includes	Display <code>#included</code> file names as they are encountered. The default is <code>off</code> .
-C, -retain_comments	Retain comments in preprocessed output. The default is <code>off</code> .
-U, -undefine foo	Undefine a preprocessor macro.
-[no_]idl_strict	Strict OMG-standard interpretation of IDL source. The default is <code>off</code> .
-[no_]warn_unrecognized_pragmas	Warn if a <code>#pragma</code> is not recognized. The default is <code>on</code> .
-[no_]back_compat_mapping	Use mapping that is compatible with VisiBroker 3.x.
-h, -help, -usage, -?	Print this usage information.
-version	Display software version numbers.
-install <service name>	Install as a NT service.
-remove <service name>	Uninstall this NT service.

The following example shows how an Interface Repository named `TestIR` can be created from a file called `Bank.idl`.

```
irep TestIR Bank.idl
```

## Viewing the contents of the Interface Repository

You can view the contents of the Interface Repository with either the VisiBroker `ir2idl` utility, or the VisiBroker Console application. The syntax for the `ir2idl` utility is:

```
ir2idl [-irep <IRname>]
```

The syntax for viewing the contents of an Interface Repository in the `irep` is described in the following table:

Syntax	Description
<code>-irep &lt;IRname&gt;</code>	Directs the program to bind to the Interface Repository instance named <code>IRname</code> . If the option is not specified, it binds to any Interface Repository returned by the Smart Agent.

## Updating an Interface Repository with idl2ir

You can update an Interface Repository with the VisiBroker `idl2ir` utility, which is an IR client. The syntax for the `idl2ir` utility is:

```
idl2ir [arguments] <idl_file_list>
```

The following example shows how the `TestIR` Interface Repository would be updated with definitions from the `Bank.idl` file.

```
idl2ir -irep TestIR -replace Bank.idl
```

Entries in an Interface Repository cannot be removed using the `idl2ir` or `irep` utilities. To remove an item:

- Exit or quit the `irep` program.
- Edit the IDL file named in the `irep` command line.
- Start `irep` again with the updated file.

Interface repositories have a simple transaction service. If the specified IDL file fails to load, the Interface Repository rolls back its content to its previous state. After loading the IDL, the Interface Repository commits its state to be used in subsequent transactions. For any repository, there is a file `<IRname>.rollback` in the home directory that contains the state of the last uncommitted transaction.

If you wish to remove all entries in the Interface Repository, you can replace the contents with a new empty IDL file. For example, using an IDL file named `Empty.idl`, you could run the following command:

```
idl2ir -irep TestIR -replace Empty.idl
```

## Understanding the structure of the Interface Repository

An Interface Repository organizes the objects it contains into a hierarchy that corresponds to the way interfaces are defined in an IDL specification. Some objects in the Interface Repository contain other objects, just as an IDL module definition might contain several interface definitions. Consider how the example IDL file shown below would translate to a hierarchy of objects in an Interface Repository.

```
// Bank.idl
module Bank {
    interface Account {
        float balance();
    };
    interface AccountManager {
        Account open(in string name);
    };
};
```

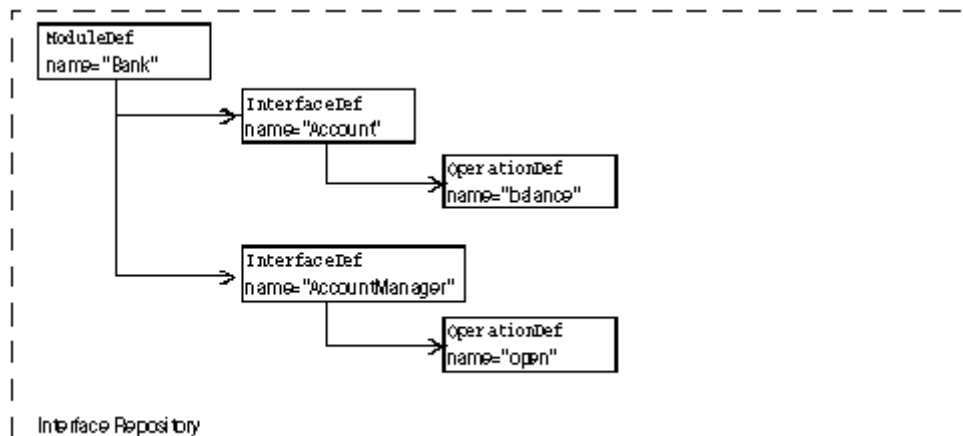
**Figure 31** Interface repository object hierarchy for Bank.idl

The `OperationDef` object contains references to additional data structures (not interfaces) that hold the parameters and return type.

## Identifying objects in the Interface Repository

The following table shows the objects that are provided to identify and classify Interface Repository objects.

Item	Description
name	A character string that corresponds to the identifier assigned in an IDL specification to a module, interface, operation, and so forth. An identifier is not necessarily unique.
id	A character string that uniquely identifies an <code>IRObj</code> ect. A <code>RepositoryID</code> contains three components, separated by colon ( <code>:</code> ) delimiters. The first component is <code>IDL:</code> and the last is a version number such as <code>:1.0</code> . The second component is a sequence of identifiers separated by slash ( <code>/</code> ) characters. The first identifier is typically a unique prefix.
def_kind	An enumeration that defines values which represent all the possible types of Interface Repository objects.

## Types of objects that can be stored in the Interface Repository

The following table summarizes the objects that can be contained in an Interface Repository. Most of these objects correspond to IDL syntax elements. A `StructDef`, for example, contains the same information as an IDL struct declaration, an `InterfaceDef` contains the same information as an IDL interface declaration, all the way down to a `PrimitiveDef` which contains the same information as an IDL primitive (`boolean`, `long`, and so forth.) declaration.

Object type	Description
Repository	Represents the top-level module that contains all other objects.
ModuleDef	Represents an IDL module declaration that can contain <code>ModuleDefs</code> , <code>InterfaceDefs</code> , <code>ConstantDefs</code> , <code>AliasDefs</code> , <code>ExceptionDefs</code> , and the IR equivalents of other IDL constructs that can be defined in IDL modules.
InterfaceDef	Represents an IDL interface declaration and contain <code>OperationDefs</code> , <code>ExceptionDefs</code> , <code>AliasDefs</code> , <code>ConstantDefs</code> , and <code>AttributeDefs</code> .
AttributeDef	Represents an IDL attribute declaration.

Object type	Description
OperationDef	Represents an IDL operation (method) declaration. Defines an operation on an interface. It includes a list of parameters required for this operation, the return value, a list of exceptions that may be raised by this operation, and a list of contexts.
ConstantDef	Represents an IDL constant declaration.
ExceptionDef	Represents an IDL exception declaration.
ValueDef	Represents a valuetype definition containing lists of constants, types, valuemembers, exceptions, operations, and attributes.
ValueBoxDef	Represents a simple boxed valuetype of another IDL type.
ValueMemberDef	Represents a member of the valuetype.
NativeDef	Represents a native definition. Users can not define their own natives.
StructDef	Represents an IDL structure declaration.
UnionDef	Represents an IDL union declaration.
EnumDef	Represents an IDL enumeration declaration.
AliasDef	Represents an IDL typedef declaration. Note that the IR TypedefDef interface is a base interface that defines common operations for StructDefs, UnionDefs, and others.
StringDef	Represents an IDL bounded string declaration.
SequenceDef	Represents an IDL sequence declaration.
ArrayDef	Represents an IDL array declaration.
PrimitiveDef	Represents an IDL primitive declaration: null, void, long, ushort, ulong, float, double, boolean, char, octet, any, TypeCode, Principal, string, objref, longlong, ulonglong, longdouble, wchar, wstring.

## Inherited interfaces

Three non-instantiatable (that is, abstract) IDL interfaces define common methods that are inherited by many of the objects contained in an IR (see the table above). The following table summarizes these widely inherited interfaces. For more information on the other methods for these interfaces, see the VisiBroker *Programmer's Reference*.

Interface	Inherited by	Principal query methods
IRObject	All IR objects including Repository	def_kind() returns an IR object's definition kind, for example, module or interface destroy() destroys an IR object
Container	IR objects that can contain other IR objects, for example, module or interface	lookup() looks up a contained object by name contents() lists the objects in a Container describe_contents() describes the objects in a Container
Contained	IR objects that can be contained in other objects, that is, Containers	name() name of this object defined_in() Container that contains an object describe() describes an object move () moves an object into another container

## Accessing an Interface Repository

Your client program can use an Interface Repository's IDL interface to obtain information about the objects it contains. Your client program can bind to the `Repository` and then invoke the methods shown below. A complete description of this interface can be found in the *Programmer's Reference*.

### Note

A program that uses an Interface Repository must be compiled with the `D_VIS_INCLUDE_IR` flag.

```
package org.omg.CORBA;
public interface Repository extends Container {
    ...
    org.omg.CORBA.Contained lookup_id(string id);
    org.omg.CORBA.PrimitiveDef
    get_primitive(org.omg.CORBA.PrimitiveKind kind);
    org.omg.CORBA.StringDef create_string(long bound);
    org.omg.CORBA.SequenceDef create_sequence(long bound,
        org.omg.CORBA.IDLType element_type);
    org.omg.CORBA.ArrayDef create_array(long length,
        org.omg.CORBA.IDLType element_type);
    ...
}
```

## Interface Repository example program

This section describes a simple Interface Repository example which contains an `AccountManager` interface to create an account and (re)open an account. This example code can be found in the following directory:

```
<install_dir>\vbroker\examples\ir
```

At the initialization time the `AccountManager` implementation bootstraps the Interface Repository definition for the managed `Account` interface. This exposes the additional operation that has been already implemented by this particular `Account` implementation to the clients. The clients now can access all known operations (which are described in IDL) and, additionally, they can verify with the Interface Repository support for other operations and invoke them. The example illustrates how we can manage Interface Repository definition objects and how to introspect remote objects using the Interface Repository.

Before this program can be tested, the following conditions should exist:

- `OSAgent` should be up and running. For more information, see [“Using the Smart Agent.”](#)
- Interface repository should be started using `irep`. For more information, see [“Creating and viewing an Interface Repository with irep.”](#)
- Interface Repository should be loaded with an IDL file either by the command line when you start the Interface Repository, or by using `idl2ir`. For more information, see [“Updating an Interface Repository with idl2ir.”](#)
- Start the client program.

## Looking up an interface's operations and attributes in an IR:

```

//Client.java
import org.omg.CORBA.InterfaceDef;
import org.omg.CORBA.InterfaceDefHelper;
import org.omg.CORBA.Request;
import java.util.Random;
public class Client {
    public static void main(String[] args) {
        try {
            // Initialize the ORB.
            org.omg.CORBA.ORB orb = org.omg.CORBA.ORB.init(args,null);
            // Get the manager Id
            byte[] managerId = "BankManager".getBytes();
            // Locate an account manager. Give the full POA name and the
            // servant ID.
            Bank.AccountManager manager = Bank.AccountManagerHelper.bind(orb,
"/bank_ir_poa", managerId);
            // use args[0] as the account name, or a default.
            String name = args.length > 0 ? args[0] : "Jack B. Quick";
            // Request the account manager to open a named account.
            Bank.Account account = manager.open(name);
            // Get the balance of the account.
            float balance = account.balance();
            // Print out the balance.
            System.out.println("The balance in " + name + "'s account is $" +
                balance);
            // Calculate and set a new balance
            balance = args.length > 1 ? Float.parseFloat(args[1]) :
                Math.abs(new Random().nextInt()) % 100000 / 100f;
            account.balance(balance);
            // Get the balance description if it is possible and print it
            String desc = getDescription(account);
            System.out.println("Balance description:\n" + desc);
        } catch (org.omg.CORBA.SystemException e) {
            System.err.println("System exception caught:" + e);
        } catch (Exception e) {
            System.err.println("Unexpected exception caught:");
            e.printStackTrace();
        }
    }

    static String getDescription (Bank.Account account) {
        // Get the interface repository definition for this interface
        InterfaceDef accountDef =
            InterfaceDefHelper.narrow(account._get_interface_def());
        // Check if this *particular* implementation supports "describe"
        // operation
        if (accountDef.lookup("describe") != null) {
            // We cannot use the static skeleton's method here because at the
            // time of its creation this method was not present in the IDL's
            // version of the Account interface. Use DII instead.
            Request request = account._request("describe");
            request.result().value().insert_string("");
            request.invoke();
            return request.result().value().extract_string();
        } else {
            return "<no description>";
        }
    }
}

```



# Using the Dynamic Invocation Interface

The developers of most client programs know the types of the CORBA objects their code will invoke, and they include the compiler-generated stubs for these types in their code. By contrast, developers of generic clients cannot know what kinds of objects their users will want to invoke. Such developers use the Dynamic Invocation Interface (DII) to write clients that can invoke any method on any CORBA object from knowledge obtained at runtime.

## What is the dynamic invocation interface?

The Dynamic Invocation Interface (DII) enables a client program to invoke a method on a CORBA object whose type was unknown at the time the client was written. The DII contrasts with the default static invocation, which requires that the client source code include a compiler-generated stub for each type of CORBA object that the client intends to invoke. In other words, a client that uses static invocation declares in advance the types of objects it will invoke. A client that uses the DII makes no such declaration because its programmer does not know what kinds of objects will be invoked. The advantage of the DII is flexibility; it can be used to write generic clients that can invoke any object, including objects whose interfaces did not exist when the client was compiled. The DII has two disadvantages:

- It is more difficult to program (in essence, your code must do the work of a stub).
- Invocations take longer because more work is done at runtime.

The DII is purely a client interface. Static and dynamic invocations are identical from an object implementation's point of view.

You can use the DII to build clients like these:

- **Bridges or adapters between script environments and CORBA objects.** For example, a script calls your bridge, passing object and method identifiers and parameter values. Your bridge constructs and issues a dynamic request, receives the result, and returns it to the scripting environment. Such a bridge could not use static invocation because its developer could not know in advance what kinds of objects the script environment would want to invoke.
- **Generic object testers.** For example, a client takes an arbitrary object identifier, looks up its interface in the interface repository (see [“Using Interface Repositories”](#)), and then invokes each of its methods with artificial argument values. Again, this style of generic tester could not be built with static invocation.

### Note

Clients **must** pass valid arguments in DII requests. Failure to do so can produce unpredictable results, including server crashes. Although it is possible to dynamically type-check parameter values with the interface repository, it is expensive. For best performance, ensure that the code (for example, script) that invokes a DII-using client can be trusted to pass valid arguments.

## Introducing the main DII concepts

The dynamic invocation interface is actually distributed among a handful of CORBA interfaces. Furthermore, the DII frequently offers more than one way to accomplish a task—the trade-off being programming simplicity versus performance in special situations. As a result, DII is one of the more difficult CORBA facilities to grasp. This section is a starting point, a high-level description of the main ideas.

To use the DII you need to understand these concepts, starting from the most general:

- Request objects
- Any and Typecode objects
- Request sending options
- Reply receiving options

### Using request objects

A `Request` object represents one invocation of one method on one CORBA object. If you want to invoke two methods on the same CORBA object, or the same method on two different objects, you need two `Request` objects. To invoke a method you first need the *target reference*, an object reference representing the CORBA object. Using the target reference, you create a `Request`, populate it with arguments, send the `Request`, wait for the reply, and obtain the result from the `Request`.

There are two ways to create a `Request`. The simpler way is to invoke the target object's `_request` method, which all CORBA objects inherit. This does not, in fact, invoke the target object. You pass `_request` the IDL name of the method you intend to invoke in the `Request`, for example, "get\_balance." To add argument values to a `Request` created with `_request`, you invoke the `Request`'s `add_value` method for each argument required by the method you intend to invoke. To pass one or more `Context` objects to the target, you must add them to the `Request` with its `ctx` method.

Although not intuitively obvious, you must also specify the type of the `Request`'s result with its `result` method. For performance reasons, the messages exchanged between the VisiBroker ORBs do not contain type information. By specifying a place holder result type in the `Request`, you give the VisiBroker ORB the information it needs to properly extract the result from the reply message sent by the target object. Similarly, if the method you are invoking can raise user exceptions, you must add place holder exceptions to the `Request` before sending it.

The more complicated way to create a `Request` object is to invoke the target object's `_create_request` method, which, again, all CORBA objects inherit. This method takes several arguments which populate the new `Request` with arguments and specify the types of the result and user exceptions, if any, that it may return. To use the `_create_request` method you must have already built the components that it takes as arguments. The potential advantage of the `_create_request` method is performance. You can reuse the argument components in multiple `_create_request` calls if you invoke the same method on multiple target objects.

#### Note

There are two overloaded forms of the `_create_request` method: one that includes `ContextList` and `ExceptionList` parameters, and one that does not. If you want to pass one or more `Context` objects in your invocation,

and/or the method you intend to invoke can raise one or more user exceptions, you must use the `_create_request` method that has the extra parameters.

## Encapsulating arguments with the Any type

The target method's arguments, result, and exceptions are each specified in special objects called *Any*s. An *Any* is a generic object that encapsulates an argument of any type. An *Any* can hold any type that can be described in IDL. Specifying an argument to a *Request* as an *Any* allows a *Request* to hold arbitrary argument types and values without making the compiler complain of type mismatches. (The same is true of results and exceptions.)

An *Any* consists of a *TypeCode* and a value. A value is just a value, and a *TypeCode* is an object that describes how to interpret the bits in the value (that is, the value's type). Simple *TypeCode* constants for simple IDL types, such as `long` and `Object`, are built into the header files produced by the `idl2java` compiler. *TypeCodes* for IDL constructed types, such as structs, unions, and `typedefs`, have to be constructed. Such *TypeCodes* can be recursive because the types they describe can be recursive.

Consider a struct consisting of a `long` and a `string`. The *TypeCode* for the struct contains a *TypeCode* for the `long` and a *TypeCode* for the `string`. You can get a *TypeCode* at runtime from an interface repository (see "Using Interface Repositories") or by asking the VisiBroker ORB to create one by invoking `ORB::create_struct_tc` or `ORB::create_exception_tc`.

If you use the `_create_request` method, you need to put the *Any*-encapsulated target method arguments in another special object called an *NVList*. No matter how you create a *Request*, its result is encoded as an *NVList*. Everything said about arguments in this paragraph applies to results as well. "NV" stands for named value, and an *NVList* consists of a count and number of items, each of which has a name, a value, and a flag. The name is the argument name, the value is the *Any* encapsulating the argument, and the flag denotes the argument's IDL mode (for example, `in` or `out`). The result of *Request* is represented a single named value.

## Options for sending requests

Once you create and populate a *Request* with arguments, a result type, and exception types, you send it to the target object. There are several ways to send a *Request*,

- The simplest is to call the *Request*'s `invoke` method, which blocks until the reply message is received.
- More complex, but not blocking, is the *Request*'s `send_deferred` method. This is an alternative to using threads for parallelism. For many operating systems the `send_deferred` method is more economical than spawning a thread.
- If your motivation for using the `send_deferred` method is to invoke multiple target objects in parallel, you can use the VisiBroker ORB object's `send_multiple_requests_deferred` method instead. It takes a sequence of *Request* objects.
- Use the *Request*'s `send_oneway` method if, and only if, the target method has been defined in IDL as `oneway`.
- You can invoke multiple `oneway` methods in parallel with the VisiBroker ORB's `send_multiple_requests_oneway` method.

## Options for receiving replies

If you send a `Request` by calling its `invoke` method, there is only one way to get the result: use the `Request` object's `env` method to test for an exception, and if none, extract the `NamedValue` from the `Request` with its `result` method. If you used the `send_oneway` method, then there is no result. If you used the `send_deferred` method, you can periodically check for completion by calling the `Request`'s `poll_response` method which returns a code indicating whether the reply has been received. If, after polling for a while, you want to block waiting for completion of a deferred send, use the `Request`'s `get_response` method.

If you have sent `Requests` with the `send_multiple_requests_deferred` method, you can find out if a particular `Request` is complete by invoking that `Request`'s `get_response` method. To learn when any outstanding `Request` is complete, use the `VisiBroker ORB`'s `get_next_response` method. To do the same thing without risking blocking, use the `VisiBroker ORB`'s `poll_next_response` method.

## Steps for invoking object operations dynamically

To summarize, here are the steps that a client follows when using the DII,

- 1 Obtain a generic reference to the target object you wish to use.
- 2 Create a `Request` object for the target object.
- 3 Initialize the request parameters and the result to be returned.
- 4 Invoke the request and wait for the results.
- 5 Retrieve the results.

## Example programs for using the DII

Several example programs that illustrate the use of the DII are included in the following directory:

```
<install_dir>/examples/vbroker/basic/bank_dynamic
```

These example programs are used to illustrate DII concepts in this section.

## Using the `idl2java` compiler

The `idl2java` compiler has a flag (`-dynamic_marshall`) which, when switched on, generates stub code using DII. To understand how to do any type of DII:

- 1 Create an IDL file,
- 2 Generate with `-dynamic_marshall`,
- 3 Look at the stub code.

## Obtaining a generic object reference

When using the DII, a client program does not have to use the traditional `bind` mechanism to obtain a reference to the target object, because the class definition for the target object may not have been known to the client at compile time.

The code sample below shows how your client program can use the `bind` method offered by the `VisiBroker ORB` object to bind to any object by

specifying its name. This method returns a generic `org.omg.CORBA.Object`.

```

...
org.omg.CORBA.ORB orb;
org.omg.CORBA.Object account;
try {
    // initialize the ORB.
orb = org.omg.CORBA.ORB.init(args, null);
} catch(Exception e) {
    System.err.println ("Failure during ORB_init");
    e.printStackTrace();
}
...
try {
    // Request ORB to bind to the object supporting the
    account interface.
    account =
((com.inprise.vbroker.CORBA.ORB)orb).bind("IDL:Account:1.0
", "", "", null);
} catch(Exception excep) {
    System.err.println ("Error binding to account" );
    excep.printStackTrace();
}
System.out.println ("Bound to account object");
...

```

## Creating and initializing a request

When your client program invokes a method on an object, a `Request` object is created to represent the method invocation. The `Request` object is written, or *marshalled*, to a buffer and sent to the object implementation. When your client program uses client stubs, this processing occurs transparently. Client programs that wish to use the DII must create and send the `Request` object themselves.

### Note

There is no constructor for this class. The `Object`'s `_request` method or `Object`'s `_create_request` method are used to create a `Request` object.

## Request interface

The following code sample shows the `Request` interface. The target of the request is set implicitly from the object reference used to create the `Request`. The name of the operation must be specified when the `Request` is created.

```

package org.omg.CORBA;
public abstract class Request {
    public abstract org.omg.CORBA.Object target();
    public abstract java.lang.String operation();
    public abstract org.omg.CORBA.NVList arguments();
    public abstract org.omg.CORBA.NamedValue result();
    public abstract org.omg.CORBA.Environment env();
    public abstract org.omg.CORBA.ExceptionList
exceptions();
    public abstract org.omg.CORBA.ContextList contexts();
    public abstract void ctx(org.omg.CORBA.Context ctx);

```

```

public abstract org.omg.CORBA.Context ctx();
public abstract org.omg.CORBA.Any add_in_arg();
public abstract org.omg.CORBA.Any add_named_in_arg(
public abstract org.omg.CORBA.Any add_inout_arg();
public abstract org.omg.CORBA.Any add_named_inout_arg(
public abstract org.omg.CORBA.Any add_out_arg();
public abstract org.omg.CORBA.Any add_named_out_arg(
public abstract void set_return_type(
public abstract org.omg.CORBA.Any return_value();
public abstract void invoke();
public abstract void send_oneway();
public abstract void send_deferred();
public abstract void get_response();
public abstract boolean poll_response();
}

```

## Ways to create and initialize a DII request

Once you have issued a bind to an object and obtained an object reference, you can use one of two methods for creating a Request object.

The following sample shows the methods offered by the `org.omg.CORBA.Object` interface.

```

package org.omg.CORBA;
public interface Object {
...
    public org.omg.CORBA.Request _request(java.lang.String
operation);
    public org.omg.CORBA.Request _create_request(
        org.omg.CORBA.Context ctx,
        java.lang.String operation,
        org.omg.CORBA.NVList arg_list,
        org.omg.CORBA.NamedValue result
    );
    public org.omg.CORBA.Request _create_request(
        org.omg.CORBA.Context ctx,
        java.lang.String operation,
        org.omg.CORBA.NVList arg_list,
        org.omg.CORBA.NamedValue result,
        org.omg.CORBA.ExceptionList exceptions,
        org.omg.CORBA.ContextList contexts
    );
...
}

```

## Using the create\_request method

You can use the `_create_request` method to create a Request object, initialize the Context, the operation name, the argument list to be passed, and the result. Optionally, you can set the ContextList for the request, which corresponds to the attributes defined in the request's IDL. The request parameter points to the Request object that was created for this operation.

## Using the \_request method

The code sample in [“Example of creating a Request object”](#) shows the use of the `_request` method to create a Request object, specifying only the operation

name. After creating a float request, calls to its `add_in_arg` method add an input parameter Account name. Its result type is initialized as an Object reference type via a call to `set_return_type` method. After a call has been made, the return value is extracted with the result's call to the `result` method. The same steps are repeated to invoke another method on an Account Manager instance with the only difference being in-parameters and return types.

The `req`, an Any object is initialized with the desired account name and added to the request's argument list as an input argument. The last step in initializing the request is to set the `result` value to receive a float.

## Example of creating a Request object

A Request object maintains ownership of all memory associated with the operation, the arguments, and the result so you should never attempt to free these items. The following code sample is an example of creating a request object.

```
// Client.java
public class Client {
    public static void main(String[] args) {
        if (args.length != 2) {
            System.out.println("Usage: vbj Client <manager-
name> <account-name>\
n");
            return;
        }
        String managerName = args[0];
        String accountName = args[1];
        org.omg.CORBA.Object accountManager, account;
        org.omg.CORBA.ORB orb = org.omg.CORBA.ORB.init(args,
null);
        accountManager =
((com.inprise.vbroker.CORBA.ORB)orb).bind("IDL:Bank/
AccountManager:1.0",
managerName, null, null);
        org.omg.CORBA.Request request =
accountManager._request("open");
        request.add_in_arg().insert_string(accountName);
        request.set_return_type(orb.get_primitive_tc(
org.omg.CORBA.TCKind.tk_objref)
);
        request.invoke();
        account = request.result().value().extract_Object();
        org.omg.CORBA.Request request =
account._request("balance");
        request.set_return_type(orb.get_primitive_tc(
org.omg.CORBA.TCKind.tk_float)
);
        request.invoke();
        float balance =
request.result().value().extract_float();
        System.out.println("The balance in " + accountName +
"'s account is
$" + balance);
    }
}
```

## Setting arguments for the request

The arguments for a Request are represented with a `NVList` object, which stores name-value pairs as `NamedValue` objects. You can use the `arguments` method to obtain a pointer to this list. This pointer can then be used to set the names and values of each of the arguments.

### Note

Always initialize the arguments before sending a Request. Failure to do so will result in marshalling errors and may even cause the server to abort.

## Implementing a list of arguments with the NVList

This class implements a list of `NamedValue` objects that represent the arguments for a method invocation. Methods are provided for adding, removing, and querying the objects in the list. The following code sample is an example of the `NVList` class:

```
package org.omg.CORBA;
public abstract class NVList {
    public int count();
    public void add(int flags);
    public void add_item(java.lang.String name, int flags);
    public void add_value(
        java.lang.String name,
        org.omg.CORBA.Any value,
        int flags
    );
    public org.omg.CORBA.NamedValue item(int index);
    public void remove(int index);
}
```

## Setting input and output arguments with the NamedValue Class

This class implements a name-value pair that represents both input and output arguments for a method invocation request. The `NamedValue` class is also used to represent the result of a request that is returned to the client program. The `name` property is simply a character string and the `value` property is represented by an `Any` class. The following code sample is an example of the `NamedValue` class.

There is no constructor for this class. The `ORB.create_named_value` method is used to obtain a reference to a `NamedValue` object.

```
package org.omg.CORBA;
public abstract class NamedValue {
    public java.lang.String name();
    public org.omg.CORBA.Any value();
    public int flags();
}
```

The following table describes the methods in the `NamedValue` class.

Method	Description
<code>name</code>	Returns a pointer to the name of the item that you can then use to initialize the name.
<code>value</code>	Returns a pointer to an <code>Any</code> object representing the item's value that you can then use to initialize the value. For more information, see <a href="#">"Passing type safely with the Any class"</a> .
<code>flags</code>	Indicates if this item is an input argument, an output argument, or both an input and output argument. If the item is both an input and output argument, you can specify a flag indicating that the VisiBroker ORB should make a copy of the argument and leave the caller's memory intact. Flags are <code>ARG_IN</code> , <code>ARG_OUT</code> , and <code>ARG_INOUT</code> .



## Passing type safely with the Any class

This class is used to hold an IDL-specified type so that it may be passed in a type-safe manner.

Objects of this class have a reference to a `TypeCode` that defines the contained object's type and a reference to the contained object. Methods are provided to construct, copy, and release an object as well as initialize and query the object's value and type. In addition, streaming operators methods are provided to read and write the object from and to a stream. The following code sample is an example.

```
package org.omg.CORBA;
public abstract class Any {
    public abstract TypeCode type();
    public abstract void type(TypeCode type);
    public abstract void read_value(InputStream input,
    TypeCode type);
    public abstract void write_value(OutputStream output);
    public abstract boolean equal(Any rhs);
    ...
}
```

## Representing argument or attribute types with the TypeCode class

This class is used by the Interface Repository and the IDL compiler to represent the type of arguments or attributes. `TypeCode` objects are also used in a `Request` object to specify an argument's type, in conjunction with the `Any` class.

`TypeCode` objects have a `kind` and `parameter list` property, represented by one of the values defined by the `TCKind` class.

### Note

There is no constructor for this class. Use the `ORB.get_primitive_tc` method or one of the `ORB.create_*_tc` methods to create a `TypeCode` object.

The following table shows the kinds and parameters for the `TypeCode` objects.

Kind	Parameter list
<code>tk_abstract_interface</code>	<code>repository_id, interface_name</code>
<code>tk_alias</code>	<code>repository_id, alias_name, TypeCode</code>
<code>tk_any</code>	None
<code>tk_array</code>	<code>length, TypeCode</code>
<code>tk_boolean</code>	None
<code>tk_char</code>	None
<code>tk_double</code>	None
<code>tk_enum</code>	<code>repository_id, enum-name, enum-id<sup>1</sup>, enum-id<sup>2</sup>, ... enum-id<sup>n</sup></code>
<code>tk_except</code>	<code>repository_id, exception_name, StructMembers</code>
<code>tk_fixed</code>	<code>digits, scale</code>
<code>tk_float</code>	None
<code>tk_long</code>	None
<code>tk_longdouble</code>	None

Kind	Parameter list
tk_longlong	None
tk_native	id, name
tk_null	None
tk_objref	repository_id, interface_id
tk_octet	None
tk_Principal	None
tk_sequence	TypeCode, maxlen
tk_short	None
tk_string	maxlen-integer
tk_struct	repository_id, struct-name, {member <sup>1</sup> , TypeCode <sup>1</sup> }, {member <sup>n</sup> , TypeCode <sup>n</sup> }
tk_TypeCode	None
tk_ulong	None
tk_ulonglong	None
tk_union	repository_id, union-name, switch TypeCode, {label- value <sup>1</sup> , member-name <sup>1</sup> , TypeCode <sup>1</sup> }, {label <sup>1</sup> -value <sup>n</sup> , member-name <sup>n</sup> , TypeCode <sup>n</sup> }
tk_ushort	None
tk_value	repository_id, value_name, boxType
tk_value_box	repository_id, value_name, typeModifier, concreteBase, members
tk_void	None
tk_wchar	None
tk_wstring	None

TypeCode class:

```

public abstract class TypeCode extends java.lang.Object
    implements org.omg.CORBA.portable.IDLEntity {
    public abstract boolean equal(org.omg.CORBA.TypeCode
tc);
    public boolean equivalent(org.omg.CORBA.TypeCode tc);
    public abstract org.omg.CORBA.TCKind kind();
    public TypeCode get_compact_typecode()
    public abstract java.lang.String id()
        throws org.omg.CORBA.TypeCodePackage.BadKind;
    public abstract java.lang.String name()
        throws org.omg.CORBA.TypeCodePackage.BadKind;
    public abstract int member_count()
        throws org.omg.CORBA.TypeCodePackage.BadKind;
    public abstract java.lang.String member_name(int index)
        throws org.omg.CORBA.TypeCodePackage.BadKind,
            org.omg.CORBA.TypeCodePackage.Bounds;
    public abstract org.omg.CORBA.TypeCode member_type(int
index)
        throws org.omg.CORBA.TypeCodePackage.BadKind,
            org.omg.CORBA.TypeCodePackage.Bounds;
    public abstract org.omg.CORBA.Any member_label(int
index)
        throws org.omg.CORBA.TypeCodePackage.BadKind,
            org.omg.CORBA.TypeCodePackage.Bounds;
    public abstract org.omg.CORBA.TypeCode
discriminator_type()
        throws org.omg.CORBA.TypeCodePackage.BadKind;
    public abstract int default_index()
        throws org.omg.CORBA.TypeCodePackage.BadKind;
    public abstract int length()
        throws org.omg.CORBA.TypeCodePackage.BadKind;

```

```

public abstract org.omg.CORBA.TypeCode content_type()
    throws org.omg.CORBA.TypeCodePackage.BadKind;
public short fixed_digits()
    throws org.omg.CORBA.TypeCodePackage.BadKind;
public short fixed_scale()
    throws org.omg.CORBA.TypeCodePackage.BadKind;
public short member_visibility(int index)
    throws org.omg.CORBA.TypeCodePackage.BadKind,
        org.omg.CORBA.Bounds;
public short type_modifier()
    throws org.omg.CORBA.TypeCodePackage.BadKind;
public TypeCode concrete_base_type()
    throws org.omg.CORBA.TypeCodePackage.BadKind;
}

```

## Sending DII requests and receiving results

The Request class, as discussed in [“Creating and initializing a request”](#), provides several methods for sending a request once it has been properly initialized.

### Invoking a request

The simplest way to send a request is to call its `invoke` method, which sends the request and waits for a response before returning to your client program. The `return_value` method returns a reference to an Any object that represents the return value. The following code sample shows how to send a request with `invoke`.

```

try {
    ...
    // Create request that will be sent to the account
    object
    request = account._request("balance");
    // Set the result type
    request.set_return_type(orb.get_primitive_tc
        (org.omg.CORBA.TCKind.tk_float));
    // Execute the request to the account object
    request.invoke();
    // Get the return balance
    float balance;
    org.omg.CORBA.Any balance_result =
    request.return_value();
    balance = balance_result.extract_float();
    // Print out the balance
    System.out.println("The balance in " + name + "'s
    account is $" +
        balance);
} catch(Exception e) {
    e.printStackTrace();
}

```

### Sending a deferred DII request with the `send_deferred` method

A non-blocking method, `send_deferred`, is also provided for sending operation requests. It allows your client to send the request and then use the `poll_response` method to determine when the response is available. The `get_response` method blocks until a response is received. The following codes show how these methods are used. The following sample

shows you how to use the `send_deferred` and `poll_response` methods to send a deferred DII request.

```

try {
    ...
    // Create request that will be sent to the manager
    object
    org.omg.CORBA.Request request =
manager._request("open");
    // Create argument to request
    org.omg.CORBA.Any customer = orb.create_any();
    customer.insert_string(name);
    org.omg.CORBA.NVList arguments = request.arguments();
    arguments.add_value("name" , customer,
org.omg.CORBA.ARG_IN.value);
    // Set result type
    request.set_return_type(orb.get_primitive_tc
(org.omg.CORBA.TCKind.tk_Objref));
    // Creation of a new account can take some time
    // Execute the deferred request to the manager object-
plist
    request.send_deferred();
    Thread.currentThread().sleep(1000);
    while (!request.poll_response()) {
        System.out.println(" Waiting for response...");
        Thread.currentThread().sleep(1000); // Wait one
second between polls
    }

    request.get_response();
    // Get the return value
    org.omg.CORBA.Object account;
    org.omg.CORBA.Any open_result = request.return_value();
    account = open_result.extract_Object();
    ...
} catch(Exception e) {
    e.printStackTrace();
}

```

## Sending an asynchronous DII request with the `send_oneway` method

The `send_oneway` method can be used to send an asynchronous request. Oneway requests do not involve a response being returned to the client from the object implementation.

## Sending multiple requests

A sequence of DII Request objects can be created using array of Request objects. A sequence of requests can be sent using the VisiBroker ORB methods `send_multiple_requests_oneway` or `send_multiple_requests_deferred`. If the sequence of requests is sent as oneway requests, no response is expected from the server to any of the requests.

## Receiving multiple requests

When a sequence of requests is sent using `send_multiple_requests_deferred`, the `poll_next_response` and `get_next_response` methods are used to receive the response the server sends for each request.

The VisiBroker ORB method `poll_next_response` can be used to determine if a response has been received from the server. This method returns `true` if there is at least one response available. This method returns `false` if there are no responses available.

The VisiBroker ORB method `get_next_response` can be used to receive a response. If no response is available, this method will block until a response is received. If you do not wish your client program to block, use the `poll_next_response` method to first determine when a response is available and then use the `get_next_response` method to receive the result. The following code sample shows an example of receiving multiple requests.

VisiBroker ORB methods for sending multiple requests and receiving the results:

```
package org.omg.CORBA;
public abstract class ORB {
    public abstract org.omg.CORBA.Environment
    create_environment();
    public abstract void
    send_multiple_requests_oneway(org.omg.CORBA.Request []
    reqs);
    public abstract void
    send_multiple_requests_deferred(org.omg.CORBA.Request []
    reqs);
    public abstract boolean poll_next_response();
    public abstract org.omg.CORBA.Request
    get_next_response();
    ...
}
```

## Using the interface repository with the DII

One source of the information needed to populate a DII `Request` object is an interface repository (IR) (see [“Using Interface Repositories”](#)). The following example uses an interface repository to get obtain the parameters of an operation. Note that the example, atypical of real DII applications, has built-in knowledge of a remote object’s type (`Account`) and the name of one of its methods (`balance`). An actual DII application would get that information from an outside source, for example, a user.

- Binds to any `Account` object.
- Looks up the `Account`’s `balance` method in the IR and builds an operation list from the IR `OperationDef`.
- Creates argument and result components and passes these to the `_create_request` method. Note that the `balance` method does not return an exception.
- Invokes the `Request`, extracts and prints the result.



# Using the Dynamic Skeleton Interface

This section describes how object servers can dynamically create object implementations at run time to service client requests.

## What is the Dynamic Skeleton Interface?

The Dynamic Skeleton Interface (DSI) provides a mechanism for creating an object implementation that does not inherit from a generated skeleton interface. Normally, an object implementation is derived from a skeleton class generated by the `idl2java` compiler. The DSI allows an object to register itself with the VisiBroker ORB, receive operation requests from a client, process the requests, and return the results to the client without inheriting from a skeleton class generated by the `idl2java` compiler.

### Note

From the perspective of a client program, an object implemented with the DSI behaves just like any other VisiBroker ORB object. Clients do not need to provide any special handling to communicate with an object implementation that uses the DSI.

The VisiBroker ORB presents client operation requests to a DSI object implementation by calling the object's `invoke` method and passing it a `ServerRequest` object. The object implementation is responsible for determining the operation being requested, interpreting the arguments associated with the request, invoking the appropriate internal method or methods to fulfill the request, and returning the appropriate values.

Implementing objects with the DSI requires more manual programming activity than using the normal language mapping provided by object skeletons. However, an object implemented with the DSI can be very useful in providing inter-protocol bridging.

## Using the `idl2java` compiler

The `idl2java` compiler has a flag (`-dynamic_marshall`) which, when switched on, generates skeleton code using DSI. To understand how to do any type of DSI:

- 1 Create an IDL file,
- 2 Generate with `-dynamic_marshall`,
- 3 Look at the skeleton code.

## Steps for creating object implementations dynamically

To create object implementations dynamically using the DSI:

- 1 When compiling your IDL use the `-dynamic_marshal` flag.
- 2 Design your object implementation so that it is derived from the `org.omg.PortableServer.DynamicImplementation` interface instead of deriving your object implementation from a skeleton class.
- 3 Declare and implement the `invoke` method, which the VisiBroker ORB will use to dispatch client requests to your object.
- 4 Register your object implementation (POA servant) with the POA manager as the default servant.

### Example program for using the DSI

An example program that illustrates the use of the DSI is located in the following directory:

```
<install_dir>/examples/vbroker/basic/bank_dynamic
```

This example is used to illustrate DSI concepts in this section. The `Bank.idl` file, shown below, illustrates the interfaces implemented in this example.

```
// Bank.idl
module Bank {
    interface Account {
        float balance();
    };
    interface AccountManager {
        Account open(in string name);
    };
};
```

### Extending the DynamicImplementation class

To use the DSI, object implementations should be derived from the `DynamicImplementation` base class shown below. This class offers several constructors and the `invoke` method, which you must implement.

```
package org.omg.CORBA;
public abstract class DynamicImplementation extends
Servant {
    public abstract void invoke(ServerRequest request);
    ...
}
```

### Example of designing objects for dynamic requests

The code sample below shows the declaration of the `AccountImpl` class that is to be implemented with the DSI. It is derived from the `DynamicImplementation` class, which declares the `invoke` method. The VisiBroker ORB will call the `invoke` method to pass client operation requests to the implementation in the form of `ServerRequest` objects.



The code sample below shows the Account class constructor and `_primary_interface` function.

```
import java.util.*;
import org.omg.PortableServer.*;
public class AccountImpl extends DynamicImplementation {
    public AccountImpl(org.omg.CORBA.ORB orb, POA poa) {
        _orb = orb;
        _poa = poa;
    }
    public synchronized org.omg.CORBA.Object get(String name) {
        org.omg.CORBA.Object obj;
        // Check if account exists
        Float balance = (Float)_registry.get(name);
        if (balance == null) {
            // simulate delay while creating new account
            try {
                Thread.currentThread().sleep(3000);
            } catch (Exception e) {
                e.printStackTrace();
            }
            // Make up the account's balance, between 0 and 1000 dollars
            balance = new Float(Math.abs(_random.nextInt()) % 100000 / 100f);
            // Print out the new account
            System.out.println("Created " + name + "'s account: " +
                balance.floatValue());
            _registry.put(name, balance);
        }
        // Return object reference
        byte[] accountId = name.getBytes();
        try {
            obj = _poa.create_reference_with_id(accountId, "IDL:Bank/
                Account:1.0");
        } catch (org.omg.PortableServer.POAPackage.WrongPolicy e) {
            throw new org.omg.CORBA.INTERNAL(e.toString());
        }
        return obj;
    }
    public String[] _all_interfaces(POA poa, byte[] objectId) { return null;
}
    public void invoke(org.omg.CORBA.ServerRequest request) {
        Float balance;
        // Get the account name from the object id
        String name = new String(_object_id());
        // Ensure that the operation name is correct
        if (!request.operation().equals("balance")) {
            throw new org.omg.CORBA.BAD_OPERATION();
        }
        // Find out balance and fill out the result
        org.omg.CORBA.NVList params = _orb.create_list(0);
        request.arguments(params);
        balance = (Float)_registry.get(name);
        if (balance == null) {
            throw new org.omg.CORBA.OBJECT_NOT_EXIST();
        }
        org.omg.CORBA.Any result = _orb.create_any();
        result.insert_float(balance.floatValue());
        request.set_result(result);
        System.out.println("Checked " + name + "'s balance: " +
            balance.floatValue());
    }
}
```

```

}
private Random _random = new Random();
static private Hashtable _registry = new Hashtable();
private POA _poa;
private org.omg.CORBA.ORB _orb;
}

```

The following code sample shows the implementation of the AccountManagerImpl class that need to be implemented with the DSI. It is also derived from the DynamicImplementation class, which declares the invoke method. The VisiBroker ORB will call the invoke method to pass client operation requests to the implementation in the form of ServerRequest objects.

```

import org.omg.PortableServer.*;
public class AccountManagerImpl extends DynamicImplementation {
    public AccountManagerImpl(org.omg.CORBA.ORB orb, AccountImpl accounts) {
        _orb = orb;
        _accounts = accounts;
    }
    public synchronized org.omg.CORBA.Object open(String name) {
        return _accounts.get(name);
    }
    public String[] _all_interfaces(POA poa, byte[] objectId) { return null;
}
    public void invoke(org.omg.CORBA.ServerRequest request) {
        // Ensure that the operation name is correct
        if (!request.operation().equals("open")) {
            throw new org.omg.CORBA.BAD_OPERATION();
        }

        // Fetch the input parameter
        String name = null;
        try {
            org.omg.CORBA.NVList params = _orb.create_list(1);
            org.omg.CORBA.Any any = _orb.create_any();
            any.insert_string(new String(""));
            params.add_value("name", any, org.omg.CORBA.ARG_IN.value);
            request.arguments(params);
            name = params.item(0).value().extract_string();
        } catch (Exception e) {
            throw new org.omg.CORBA.BAD_PARAM();
        }
        // Invoke the actual implementation and fill out the result
        org.omg.CORBA.Object account = open(name);
        org.omg.CORBA.Any result = _orb.create_any();
        result.insert_Object(account);
        request.set_result(result);
    }
    private AccountImpl _accounts;
    private org.omg.CORBA.ORB _orb;
}

```

## Specifying repository ids

The `_primary_interface` method should be implemented to return supported repository identifiers. To determine the correct repository identifier to specify, start with the IDL interface name of an object and use these steps:

- 1 Replace all non-leading instances of the delimiter scope resolution operator (::) with a slash (/).
- 2 Add "IDL:" to the beginning of the string.
- 3 Add ":1.0" to the end of the string.

For example, this code sample shows an IDL interface name:

```
Bank::AccountManager
```

The resulting repository identifier looks like this:

```
IDL:Bank/AccountManager:1.0
```

## Looking at the ServerRequest class

A `ServerRequest` object is passed as a parameter to an object implementation's `invoke` method. The `ServerRequest` object represents the operation request and provides methods for obtaining the name of the requested operation, the parameter list, and the context. It also provides methods for setting the result to be returned to the caller and for reflecting exceptions.

```
package org.omg.CORBA;
public abstract class ServerRequest {
    public java.lang.String operation();
    public void arguments(org.omg.CORBA.NVList args);
    public void set_result(org.omg.CORBA.Any result);
    public void set_exception(org.omg.CORBA.Any except);
    public abstract org.omg.CORBA.Context ctx();
    // the following methods are deprecated
    public java.lang.String op_name(); // use operation()
    public void params(org.omg.CORBA.NVList params); // use
arguments()
    public void result(org.omg.CORBA.Any result); // use
set_result()
    public abstract void except(org.omg.CORBA.Any except);
    // use set_exception()
}
```

All arguments passed into the `arguments`, `set_result`, or `set_exception` methods are thereafter owned by the VisiBroker ORB. The memory for these arguments will be released by the VisiBroker ORB; you should not release them.

### Note

The following methods have been deprecated:

- `op_name`
- `params`
- `result`
- `exception`

## Implementing the Account object

The `Account` interface declares only one method, so the processing done by the `AccountImpl` class' `invoke` method is fairly straightforward.

The `invoke` method first checks to see if the requested operation has the name "balance." If the name does not match, a `BAD_OPERATION` exception

is raised. If the `Account` object were to offer more than one method, the `invoke` method would need to check for all possible operation names and use the appropriate internal methods to process the operation request.

Since the `balance` method does not accept any parameters, there is no parameter list associated with its operation request. The `balance` method is simply invoked and the result is packaged in an `Any` object that is returned to the caller, using the `ServerRequest` object's `set_result` method.

## Implementing the AccountManager object

Like the `Account` object, the `AccountManager` interface also declares one method. However, the `AccountManagerImpl` object's `open` method does accept an account name parameter. This makes the processing done by the `invoke` method a little more complicated.

The method first checks to see that the requested operation has the name "open". If the name does not match, a `BAD_OPERATION` exception is raised. If the `AccountManager` object were to offer more than one method, its `invoke` method would need to check for all possible operation names and use the appropriate internal methods to process the operation request.

### Processing input parameters

The following are the steps the `AccountManagerImpl` object's `invoke` method uses to process the operation request's input parameters.

- 1 Create an `NVList` to hold the parameter list for the operation.
- 2 Create `Any` objects for each expected parameter and add them to the `NVList`, setting their `TypeCode` and parameter type (`ARG_IN`, `ARG_OUT`, or `ARG_INOUT`).
- 3 Invoke the `ServerRequest` object's `sarguments` method, passing the `NVList`, to update the values for all the parameters in the list.

The `open` method expects an account name parameter; therefore, an `NVList` object is created to hold the parameters contained in the `ServerRequest`. The `NVList` class implements a parameter list containing one or more `NamedValue` objects. The `NVList` and `NamedValue` classes are described in "[Using the Dynamic Invocation Interface](#)".

An `Any` object is created to hold the account name. This `Any` is then added to `NVList` with the argument's name set to `name` and the parameter type set to `ARG_IN`.

Once the `NVList` has been initialized, the `ServerRequest` object's `sarguments` method is invoked to obtain the values of all of the parameters in the list.

#### Note

After invoking the `sarguments` method, the `NVList` will be owned by the `VisiBroker` ORB. This means that if an object implementation modifies an `ARG_INOUT` parameter in the `NVList`, the change will automatically be apparent to the `VisiBroker` ORB. This `NVList` should not be released by the caller.

An alternative to constructing the `NVList` for the input arguments is to use the `VisiBroker` ORB object's `create_operation_list` method. This method accepts an `OperationDef` and returns an `NVList` object, completely

initialized with all the necessary Any objects. The appropriate OperationDef object may be obtained from the interface repository, described in [“Using Interface Repositories”](#).

## Setting the return value

After invoking the ServerRequest object's arguments method, the value of the name parameter can be extracted and used to create a new Account object. An Any object is created to hold the newly created Account object, which is returned to the caller by invoking the ServerRequest object's set\_result method.

## Server implementation

The implementation of the main routine, shown in the following code sample, is almost identical to the original example in [“Developing an example application with VisiBroker”](#).

```
import org.omg.PortableServer.*;
public class Server {
    public static void main(String[] args) {
        try {
            // Initialize the ORB
            org.omg.CORBA.ORB orb = org.omg.CORBA.ORB.init(args, null);
            // Get a reference to the root POA
            POA rootPoa =

POAHelper.narrow(orb.resolve_initial_references("RootPOA"));
            // Get the POA Manager
            POAManager poaManager = rootPoa.the_POAManager();
            // Create the account POA with the right policies
            org.omg.CORBA.Policy[] accountPolicies = {
                rootPoa.create_servant_retention_policy(
                    ServantRetentionPolicyValue.NON_RETAIN),
                rootPoa.create_request_processing_policy(
                    RequestProcessingPolicyValue.USE_DEFAULT_SERVANT)
            };
            POA accountPOA = rootPoa.create_POA("bank_account_poa",
                poaManager, accountPolicies);
            // Create the account default servant
            AccountImpl accountServant = new AccountImpl(orb, accountPOA);
            accountPOA.set_servant(accountServant);
            // Create the manager POA with the right policies
            org.omg.CORBA.Policy[] managerPolicies = {
                rootPoa.create_lifespan_policy(LifespanPolicyValue.PERSISTENT),
                rootPoa.create_request_processing_policy(
                    RequestProcessingPolicyValue.USE_DEFAULT_SERVANT)
            };
            POA managerPOA = rootPoa.create_POA("bank_agent_poa",
                poaManager, managerPolicies);
            // Create the manager default servant
            AccountManagerImpl managerServant = new AccountManagerImpl(orb,
                accountServant);
            managerPOA.set_servant(managerServant);
            // Activate the POA Manager
            poaManager.activate();
            System.out.println("AccountManager is ready");
            // Wait for incoming requests
```

```
orb.run();
} catch(Exception e) {
    e.printStackTrace();
}
}
```

DSI implementation is instantiated as a default servant and the POA should be created with the support of corresponding policies. For more information see ["Using POAs"](#).

# Using Portable Interceptors

This section provides an overview of Portable Interceptors. Several Portable Interceptor examples are discussed as well as the advanced features of Portable Interceptor factories.

For a complete description of Portable Interceptors, refer to the OMG Final Adopted Specification, ptc/2001-04-03, Portable Interceptors.

## Portable Interceptors overview

The VisiBroker ORB provides a set of interfaces known as *interceptors* which provide a framework for plugging-in additional ORB behavior such as security, transactions, or logging. These interceptor interfaces are based on a *callback* mechanism. For example, using the interceptors, you can be notified of communications between clients and servers, and modify these communications if you wish, effectively altering the behavior of the VisiBroker ORB.

At its simplest usage, the interceptor is useful for tracing through code. Because you can see the messages being sent between clients and servers, you can determine exactly how the ORB is processing requests.

**Figure 32** How Interceptors work

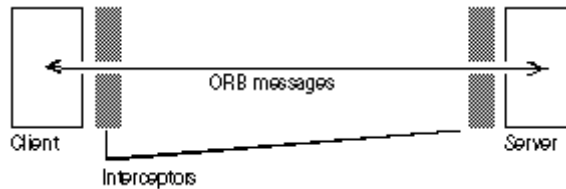

If you are building a more sophisticated application such as a monitoring tool or security layer, interceptors give you the information and control you need to enable these lower-level applications. For example, you can develop an application that monitors the activity of various servers and performs load balancing.

## Types of interceptors

There are two types of interceptors supported by the VisiBroker ORB.

Portable Interceptors	VisiBroker Interceptors
An OMG standardized feature that allows writing of portable code as interceptors, which can be used with different ORB vendors.	VisiBroker-specific interceptors. For more information, go to <a href="#">"Using VisiBroker Interceptors"</a> .

## Types of Portable Interceptors

The two kinds of Portable Interceptors defined by the OMG specification are: *Request Interceptors* and *IOR interceptors*.

Request Interceptors	IOR interceptor
Can enable the VisiBroker ORB services to transfer context information between clients and servers. Request Interceptors are further divided into <i>Client Request Interceptors</i> and <i>Server Request Interceptors</i> .	Used to enable a VisiBroker ORB service to add information in an IOR describing the server's or object's ORB-service-related capabilities. For example, a security service (like SSL) can add its tagged component into the IOR so that clients recognizing that component can establish the connection with the server based on the information in the component.

For additional information on using both Portable Interceptors and VisiBroker Interceptors, see [“Using VisiBroker Interceptors”](#).

See also the *VisiBroker for Java APIs* documentation.

## Portable Interceptor and Information interfaces

All Portable Interceptors implement one of the following base interceptor API classes which are defined and implemented by the VisiBroker ORB:

- Request Interceptor:
  - ClientRequestInterceptor
  - ServerRequestInterceptor
- IORInterceptor

### Interceptor class

All the interceptor classes listed above are derived from a common class: *Interceptor*. This *Interceptor* class has defined common methods that are available to its inherited classes.

The *Interceptor* class:

```
public interface Interceptor
    extends org.omg.CORBA.portable.IDLEntity,
           org.omg.CORBA.LocalInterface
{
    public java.lang.String name ( );
    public void destroy ( );
}
```

### Request Interceptor

A *request interceptor* is used to intercept the flow of a request/reply sequence at specific interception points so that services can transfer context information between clients and servers. For each interception point, the VisiBroker ORB gives an object through which the interceptor can access request information. There are two kinds of request interceptor and their respective request information interfaces:

- ClientRequestInterceptor and ClientRequestInfo
- ServerRequestInterceptor and ServerRequestInfo

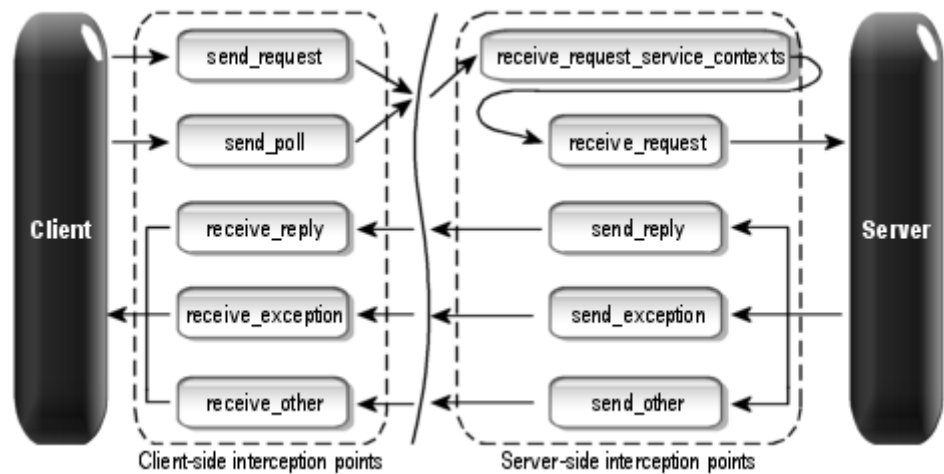

**Figure 33** Request Interception points

For more detail information on Request Interceptors, see the *VisiBroker for Java APIs* documentation.

## ClientRequestInterceptor

`ClientRequestInterceptor` has its interception points implemented on the client-side. There are five interception points defined in `ClientRequestInterceptor` by the OMG as shown in the following table:

Interception Points	Description
<code>send_request</code>	Lets a client-side Interceptor query a request and modify the service context before the request is sent to the server.
<code>send_poll</code>	Lets a client-side Interceptor query a request during a Time-Independent Invocation (TII) <sup>1</sup> polling get reply sequence.
<code>receive_reply</code>	Lets a client-side Interceptor query the reply information after it is returned from the server and before the client gains control.
<code>receive_exception</code>	Lets a client-side Interceptor query the exception's information, when an exception occurs, before the exception is sent to the client.
<code>receive_other</code>	Lets a client-side Interceptor query the information which is available when a request result other than normal reply or an exception is received.

<sup>1</sup> TII is not implemented in the VisiBroker ORB. As a result, the `send_poll ( )` interception point will never be invoked.

For more information on each interception point, see the *VisiBroker for Java APIs* documentation.

```
package org.omg.PortableInterceptor;
public interface ClientRequestInterceptor
    extends Interceptor, org.omg.CORBA.portable.IDLEntity,
    org.omg.CORBA.LocalInterface
{
    public void send_request(ClientRequestInfo ri) throws
    ForwardRequest;
    public void send_poll(ClientRequestInfo ri) throws
    ForwardRequest;
    public void receive_reply(ClientRequestInfo ri);
```

```

    public void receive_exception(ClientRequestInfo ri)
    throws ForwardRequest;
    public void receive_other(ClientRequestInfo ri) throws
    ForwardRequest;
}

```

### Client-side rules

The following are the client-side rules:

- The starting interception points are: `send_request` and `send_poll`. On any given request/reply sequence, one and only one of these interception points is called.
- The ending interception points are: `receive_reply`, `receive_exception` and `receive_other`.
- There is no intermediate interception point.
- An ending interception point is called if and only if `send_request` or `send_poll` runs successfully.
- A `receive_exception` is called with the system exception `BAD_INV_ORDER` with a minor code of 4 (ORB has shutdown) if a request is canceled because of ORB shutdown.
- A `receive_exception` is called with the system exception `TRANSIENT` with a minor code of 3 if a request is canceled for any other reason.

Successful invocations	<code>send_request</code> is followed by <code>receive_reply</code> ; a start point is followed by an end point
Retries	<code>send_request</code> is followed by <code>receive_other</code> ; a start point is followed by an end point

### ServerRequestInterceptor

`ServerRequestInterceptor` has its interception points implemented on the server-side. There are five interception points defined in `ServerRequestInterceptor`. The following table shows the `ServerRequestInterceptor` Interception points.

Interception Points	Description
<code>receive_request_service_contexts</code>	Lets a server-side Interceptor get its service context information from the incoming request and transfer it to <code>PortableInterceptor::Current</code> 's slot.
<code>receive_request</code>	Lets a server-side Interceptor query request information after all information, including operation parameters, is available.
<code>send_reply</code>	Lets a server-side Interceptor query reply information and modify the reply service context after the target operation has been invoked and before the reply is returned to the client.
<code>send_exception</code>	Lets a server-side Interceptor query the exception's information and modify the reply service context, when an exception occurs, before the exception is sent to the client.
<code>send_other</code>	Lets a server-side Interceptor query the information which is available when a request result other than normal reply or an exception is received.

For more detail on each interception point, see the *VisiBroker for Java APIs* documentation.

ServerRequestInterceptor Interface:

```
package org.omg.PortableInterceptor;
public interface ServerRequestInterceptor
    extends Interceptor, org.omg.CORBA.portable.IDLEntity,
    org.omg.CORBA.LocalInterface
{
    public void
    receive_request_service_contexts(ServerRequestInfo ri)
        throws ForwardRequest;
    public void receive_request(ServerRequestInfo ri)
    throws ForwardRequest;
    public void send_reply(ServerRequestInfo ri);
    public void send_exception(ServerRequestInfo ri) throws
    ForwardRequest;
    public void send_other(ServerRequestInfo ri) throws
    ForwardRequest;
}
```

### Server-side rules

The following are the server-side rules:

- The starting interception point is: `receive_request_service_contexts`. This interception point is called on any given request/reply sequence.
- The ending interception points are: `send_reply`, `send_exception` and `send_other`. On any given request/reply sequence, one and only one of these interception points is called.
- The intermediate interception point is `receive_request`. It is called after `receive_request_service_contexts` and before an ending interception point.
- On an exception, `receive_request` may not be called.
- An ending interception point is called if and only if `send_request` or `send_poll` runs successfully.
- A `send_exception` is called with the system exception `BAD_INV_ORDER` with a minor code of 4 (ORB has shutdown) if a request is canceled because of ORB shutdown.
- A `send_exception` is called with the system exception `TRANSIENT` with a minor code of 3 if a request is canceled for any other reason.

Successful  
invocations

The order of interception points:  
`receive_request_service_contexts`,  
`receive_request`, `send_reply`; a start point is  
followed by an intermediate point which is followed  
by an end point.

## IOR Interceptor

IORInterceptor give applications the ability to add information describing the server's or object's ORB service related capabilities to object references to enable the VisiBroker ORB service implementation in the client to function properly. This is done by calling the interception point, `establish_components`. An instance of IORInfo is passed to the interception point. For more information on IORInfo, see the *VisiBroker for Java APIs* documentation.

```
package org.omg.PortableInterceptor;
public interface IORInterceptor
    extends Interceptor, org.omg.CORBA.portable.IDLEntity,
    org.omg.CORBA.LocalInterface
{
    public void establish_components(IORInfo info);
    public void components_established(IORInfo info);
    public void adapter_manager_state_changed(int id, short
state);
    public void adapter_state_changed(
        ObjectReferenceTemplate[] templates, short state);
}
```

## Portable Interceptor (PI) Current

The `PortableInterceptor::Current` object (hereafter referred to as `PICurrent`) is a table of slots that can be used by Portable Interceptors to transfer thread context information to request context. Use of `PICurrent` may not be required. However, if client's thread context information is required at interception point, `PICurrent` can be used to transfer this information.

`PICurrent` is obtained through a call to:

```
ORB.resolve_initial_references("PICurrent");
```

PortableInterceptor.Current interface:

```
package org.omg.PortableInterceptor;
public interface Current
    extends org.omg.CORBA.CurrentOperations,
    org.omg.CORBA.portable.IDLEntity
{
    public org.omg.CORBA.Any get_slot(int id) throws
InvalidSlot;

    public void set_slot(int id, org.omg.CORBA.Any data)
throws InvalidSlot;
}
```

## Codec

Codec provides a mechanism for interceptors to transfer components between their IDL data types and their CDR encapsulation representations. A Codec is obtained from `CodecFactory`. For more information, see [“CodecFactory”](#).

The Codec interface:

```
package org.omg.IOP;
public interface Codec
    extends org.omg.CORBA.portable.IDLEntity,
    org.omg.CORBA.LocalInterface
{
    public byte[] encode(org.omg.CORBA.Any data) throws
    InvalidTypeForEncoding;
    public org.omg.CORBA.Any decode(byte[] data) throws
    FormatMismatch;
    public byte[] encode_value(org.omg.CORBA.Any data)
    throws
    InvalidTypeForEncoding;
    public org.omg.CORBA.Any decode_value(byte[] data,
    org.omg.CORBA.TypeCode tc)
    throws FormatMismatch, TypeMismatch;
}
```

## CodecFactory

This class is used to create a `Codec` object by specifying the encoding format, the major and minor versions. `CodecFactory` can be obtained with a call to:

```
ORB.resolve_initial_references("CodecFactory")
```

The `CodecFactory` interface:

```
package org.omg.IOP;
public interface CodecFactory
    extends org.omg.CORBA.portable.IDLEntity,
    org.omg.CORBA.LocalInterface
{
    public Codec create_codec(Encoding enc) throws
    UnknownEncoding;
}
```

## Creating a Portable Interceptor

The generic steps to create a Portable Interceptor are:

- 1 The Interceptor must be inherited from one of the following Interceptor interfaces:
  - ClientRequestInterceptor
  - ServerRequestInterceptor
  - IORInterceptor
- 2 The Interceptor implements one or more interception points that are available to the Interceptor.
- 3 The Interceptor can be named or anonymous. All names must be unique among all Interceptors of the same type. However, any number of anonymous Interceptors can be registered with the VisiBroker ORB.

## Example: Creating a PortableInterceptor

```
import org.omg.PortableInterceptor.*;

public class SampleClientRequestInterceptor extends
org.omg.CORBA.LocalObject
    implements ClientRequestInterceptor
{
    public java.lang.String name() {
        return "SampleClientRequestInterceptor";
    }

    public void send_request(ClientRequestInfo ri)
        throws ForwardRequest {
        ..... // actual interceptor code here
    }

    public void send_poll(ClientRequestInfo ri)
        throws ForwardRequest {
        ..... // actual interceptor code here
    }

    public void receive_reply(ClientRequestInfo ri) {
        ..... // actual interceptor code here
    }

    public void receive_exception(ClientRequestInfo ri)
        throws ForwardRequest {
        ..... // actual interceptor code here
    }

    public void receive_other(ClientRequestInfo ri)
        throws ForwardRequest {
        ..... // actual interceptor code here
    }
}
```

## Registering Portable Interceptors

Portable Interceptors must be registered with the VisiBroker ORB before they can be used. To register a Portable Interceptor, an ORBInitializer object must be implemented and registered. Portable Interceptors are instantiated and registered during ORB initialization by registering an associated ORBInitializer object which implements its `pre_init( )` or `post_init( )` method, or both. The VisiBroker ORB will call each registered ORBInitializer with an ORBInitInfo object during the initializing process.

The ORBInitializer interface:

```
package org.omg.PortableInterceptor;

public interface ORBInitializer
    extends org.omg.CORBA.portable.IDLEntity,
    org.omg.CORBA.LocalInterface
{
    public void pre_init(ORBInitInfo info);
    public void post_init(ORBInitInfo info);
}
```

The ORBInitInfo interface:

```
package org.omg.PortableInterceptor;
public interface ORBInitInfo
    extends org.omg.CORBA.portable.IDLEntity,
    org.omg.CORBA.LocalInterface
{
    public java.lang.String[] arguments();
    public java.lang.String orb_id();
    public CodecFactory codec_factory();
    public void register_initial_reference(java.lang.String
id, org.omg.CORBA.Object obj)
        throws InvalidName;
    public void resolve_initial_references(java.lang.String
id) throws InvalidName;
    public void
add_client_request_interceptor(ClientRequestInterceptor
interceptor)
        throws DuplicateName;
    public void
add_server_request_interceptor(ServerRequestInterceptor
interceptor)
        throws DuplicateName;
    public void add_ior_interceptor(IORInterceptor
interceptor) throws DuplicateName;
    public int allocate_slot_id();
    public void register_policy_factory(int type,
PolicyFactory policy_factory);
}
```

## Registering an ORBInitializer

To register an ORBInitializer, the global method `register_orb_initializer` is provided. Each service that implements Interceptors provides an instance of ORBInitializer. To use a service, an application:

- 1 calls `register_orb_initializer( )` with the service's ORBInitializer; and
- 2 makes an instantiating `ORB_Init( )` call with a new ORB identifier to produce a new ORB.

Since the `register_orb_initializer( )` is a global method, it would break applet security with respect to the ORB. As a result, ORBInitializers are registered with VisiBroker ORB by using Java ORB properties instead of calling `register_orb_initializer( )`.

The new property names are of the form:

```
org.omg.PortableInterceptor.ORBInitializerClass.<Service>
```

where `<Service>` is the string name of a class which implements `org.omg.PortableInterceptor.ORBInitializer`.

During `ORB.init( )`:

- 1 these ORB properties which begin with `org.omg.PortableInterceptor.ORBInitializerClass` are collected.
- 2 the `<Service>` portion of each property is collected.
- 3 an object is instantiated with the `<Service>` string as its class name.
- 4 the `pre_init( )` and `post_init( )` methods are called on that object.
- 5 if there is any exception, the ORB ignores them and proceeds.

**Note**

To avoid name collisions, the reverse DNS name convention is recommended. For example, if company ABC has two initializers, it could define the following properties:

```
org.omg.PortableInterceptor.ORBInitializerClass.com.abc.ORBInit1
org.omg.PortableInterceptor.ORBInitializerClass.com.abc.ORBInit2
```

**Example: Registering ORBInitializer**

A client-side monitoring tool written by company ABC may have the following ORBInitializer implementation:

```
package com.abc.Monitoring;

import org.omg.PortableInterceptor.Interceptor;
import org.omg.PortableInterceptor.ORBInitializer;
import org.omg.PortableInterceptor.ORBInitInfo;

public class MonitoringService extends
org.omg.CORBA.LocalObject
    implements org.omg.PortableInterceptor.ORBInitializer
{
    void pre_init(ORBInitInfo info)
    {
        // instantiate the service's Interceptor.
        Interceptor interceptor = new
MonitoringInterceptor();

        // register the Monitoring's Interceptor.
        info.add_client_request_interceptor(interceptor);
    }

    void post_init(ORBInitInfo info)
    {
        // This init point is not needed.
    }
}
```

The following command may be used to run a program called MyApp using this monitoring service:

```
java -
Dorg.omg.PortableInterceptor.ORBInitializerClass.com.abc.
Monitoring.MonitoringService MyApp
```

**VisiBroker extensions to Portable Interceptors****POA scoped Server Request Interceptors**

Portable Interceptors specified by OMG are scoped globally. VisiBroker has defined "POA scoped Server Request Interceptor", a public extension to the Portable Interceptors, by adding a new module call `PortableInterceptorExt`. This new module holds a local interface, `IORInfoExt`, which is inherited from `PortableInterceptor::IORInfo` and has additional methods to install POA scoped server request interceptor.

The `IORInfoExt` interface:



```

package com.inprise.vbroker.PortableInterceptor;

public interface IORInfoExt extends
    org.omg.CORBA.LocalInterface,
    org.omg.PortableInterceptor.IORInfo,

    com.inprise.vbroker.PortableInterceptor.IORInfoExtOperations,
    org.omg.CORBA.portable.IDLEntity
{
    public void
    add_server_request_interceptor(ServerRequestInterceptor
    interceptor)
        throws DuplicateName;
    public java.lang.String[] full_poa_name();
}

```

## Inserting and extracting system exceptions

To conveniently insert and extract `SystemExceptions` to and from an `Any`, a utility helper class is provided only for VisiBroker for Java. The `com.inprise.vbroker.PortableInterceptor.SystemExceptionHelper` class provides the methods to insert and extract the `SystemExceptions` into and out of an `Any` respectively. You need to import the following package:

```
import com.inprise.vbroker.PortableInterceptor.*;
```

The two methods have the following signatures:

```

public static void insert (final org.omg.CORBA.Any any,
    final org.omg.CORBA.SystemException se);
public static org.omg.CORBA.SystemException extract (final
    org.omg.CORBA.Any any);

```

## Limitations of VisiBroker Portable Interceptors implementation

The following are limitations of the Portable Interceptor implementation in VisiBroker.

### ClientRequestInfo limitations

- `arguments()`, `result()`, `exceptions()`, `contexts()`, and `operation_contexts()` are only available for DII invocations. For more information, see [“Using the Dynamic Skeleton Interface”](#).
- `received_exception()` and `received_exception_id()` will always return a `CORBA::UNKNOWN` exception and its respective repository id if a user exception is thrown by the application.

### ServerRequestInfo limitations

- `exceptions()` does not return any value; it will raise a `CORBA::NO_RESOURCES` exception in both dynamic invocations and static stub based invocation.
- `contexts()` returns the list of contexts that are available during operation invocation.
- `sending_exception()` returns the correct user exception only in the case of dynamic invocation (provided the user exception can be inserted into an `Any` or its `TypeCode` information is available).

- `arguments()`, `result()`, `contexts()`, and `operation_contexts()` are only available for DSI invocations. For more information, see [“Using the Dynamic Skeleton Interface”](#).

## Portable Interceptors examples

This section discusses how applications are actually written to make use of Portable Interceptors and how each request interceptor is implemented. Each example consists of a set of client and server applications and their respective interceptors written in Java. For more information on the definition of each interface, see the *VisiBroker for Java APIs* documentation.

We also recommend that developers who want to make use of Portable Interceptors read the chapter on Portable Interceptors in the most recent CORBA specification.

The Portable Interceptors examples are located in the following directory:

```
<install_dir>/examples/vbroker/pi
```

Each example is associated with one of the following directory names to better illustrate the objective of that example.

- `client_server`
- `chaining`

### Example: `client_server`

This section provides a detailed description, explanation, the compilation procedure, and the execution or deployment of the examples in `client_server`.

#### Objective of example

This example demonstrates how easily a Portable Interceptor can be added into an existing CORBA application without altering any code. The Portable Interceptor can be added to any application, both client and server-side, through executing the related application again, together with the specified options or properties which can be configured during runtime.

The client and server application used is similar to the one found in:

```
<install_dir>/examples/vbroker/basic/bank_agent
```

Portable Interceptors have been added to the entire example during runtime configuration. This provides developers, who are familiar with VisiBroker Interceptors, a fast way of coding between VisiBroker Interceptors and OMG specific Portable Interceptors.

#### Importing required packages

To use Portable Interceptor interfaces, inclusion of the related packages or header files is required.

#### Note

If you are using any Portable Interceptors exceptions, such as `DuplicateName` or `InvalidName`, the `ORBInitInfoPackage` is optional.

Required packages for using Portable Interceptor are:

```
import org.omg.PortableInterceptor.*;
import org.omg.PortableInterceptor.ORBInitInfoPackage.*;
```

To load a client-side request interceptor, a class that uses the `ORBInitializer` interface must be implemented. This is also applicable for server-side request interceptor as far as initialization is concerned. The following example shows the code for loading:

Proper inheritance of a `ORBInitializer` in order to load a server request interceptor:

```
public class SampleServerLoader extends
org.omg.CORBA.LocalObject implements ORBInitializer
```

### Note

Each object that implements the interface, `ORBInitializer`, is also required to inherit from the object `LocalObject`. This is necessary because the IDL definition of `ORBInitializer` uses the keyword `local`.

For more information on the IDL keyword, `local`, see [“Understanding valuetypes”](#).

During the initialization of the ORB, each request Interceptor is added through the implementation of the interface, `pre_init()`. Inside this interface, the client request Interceptor is added through the method, `add_client_request_interceptor()`. The related client request interceptor is required to be instantiated before adding itself into the ORB.

## Client-side request interceptor initialization and registration to the ORB

```
public void pre_init(ORBInitInfo info) {
    try {
        info.add_client_request_interceptor
            (new SampleClientInterceptor());
        ...
    }
```

According to the OMG specification, the Java is registered via the following Java ORB property:

```
org.omg.PortableInterceptor.ORBInitializerClass.<Service>
```

where `<Service>` is the string name of a class which implements `org.omg.PortableInterceptor.ORBInitializer`. For more information, see [“Developing the Client and Server Application”](#).

Complete implementation of the client-side interceptor loader:

```
// SampleClientLoader.java

import org.omg.PortableInterceptor.*;
import org.omg.PortableInterceptor.ORBInitInfoPackage.*;

public class SampleClientLoader extends org.omg.CORBA.LocalObject
implements ORBInitializer
{
    public void pre_init(ORBInitInfo info) {
        try {
            System.out.println("=====>SampleClientLoader: Installing ...");
            info.add_client_request_interceptor(new SampleClientInterceptor());
            System.out.println("=====>SampleClientLoader: Interceptors
```

Example: client\_server

```
loaded.");
    }
    catch(DuplicateName dn) {
        System.out.println("=====>SampleClientLoader: " + dn.name + "
already
installed.");
    }
    catch(Exception e) {
        e.printStackTrace();
        throw new org.omg.CORBA.INITIALIZE(e.toString());
    }
}
public void post_init(ORBInitInfo info) {
    // We do not do anything here.
}
}
```

## Implementing the ORBInitializer for a server-side Interceptor

At this stage, the client request interceptor should already have been properly instantiated and added. Subsequent code thereafter only provides exception handling and result display. Similarly, on the server-side, the server request interceptor is also done the same way except that it uses the, `add_server_request_interceptor()` method to add the related server request interceptor into the ORB.

Server-side request interceptor initialization and registration to the ORB:

```
public void pre_init(ORBInitInfo info) {
    try {
        info.add_server_request_interceptor
            (new SampleServerInterceptor());
        ...
    }
```

The complete implementation of the server-side interceptor loader:

```
// SampleServerLoader.java

import org.omg.PortableInterceptor.*;
import org.omg.PortableInterceptor.ORBInitInfoPackage.*;

public class SampleServerLoader extends org.omg.CORBA.LocalObject
implements ORBInitializer
{
    public void pre_init(ORBInitInfo info) {
        try {
            info.add_server_request_interceptor(new
SampleServerInterceptor());
            System.out.println("=====>SampleServerLoader: Interceptors
loaded");
        }
        catch(DuplicateName dn) {
            System.out.println("Interceptor: " + dn.name + " already
installed.");
        }
        catch(Exception e) {
```

```

        e.printStackTrace();
        throw new org.omg.CORBA.INITIALIZE(e.toString());
    }
}
public void post_init(ORBInitInfo info) {
    // We do not do anything here.
}
}

```

## Implementing the RequestInterceptor for client- or server-side Interceptor

Upon implementation of either client- or server-side request interceptor, two other interfaces must be implemented. They are `name()` and `destroy()`.

The `name()` is important here because it provides the name to the ORB to identify the correct interceptor that it will load and call during any request or reply. According to the CORBA specification, an interceptor may be anonymous, for example, it has an empty string as the name attribute. In this example, the name, `SampleClientInterceptor`, is assigned to the client-side interceptor and `SampleServerInterceptor` is assigned to the server-side interceptor.

Implementation of interface attribute, readonly attribute name:

```

    public String name() {
        return _name;
    }

```

## Implementing the ClientRequestInterceptor for Client

For the client request interceptor, it is necessary to implement the `ClientRequestInterceptor` interface for the request interceptor to work properly.

When the class implements the interface, the following five request interceptor methods are implemented regardless of any implementation:

- `send_request()`
- `send_poll()`
- `receive_reply()`
- `receive_exception()`
- `receive_other()`

In addition, the interface for the request interceptor must be implemented beforehand. On the client-side interceptor, the following request interceptor point will be triggered in relation to its events.

### The void `send_request(ClientRequestInfo ri)` method

`send_request`—provides an interception point for querying request information and modifying the service context before the request is sent to the server.

Example: client\_server

```
public void send_request(ClientRequestInfo ri) throws
ForwardRequest {
    ...
}
```

### The void send\_poll(ClientRequestInfo ri) method

send\_poll—provides an interception point for querying information during a Time-Independent Invocation (TII) polling to get the reply sequence.

```
public void send_poll(ClientRequestInfo ri) {
    ...
}
```

### The void receive\_reply(ClientRequestInfo ri) method

receive\_reply—provides an interception point for querying information on a reply after it is returned from the server and before control is returned to the client.

```
public void receive_reply(ClientRequestInfo ri) {
    ...
}
```

### The void receive\_exception(ClientRequestInfo ri) method

receive\_exception—provides an interception point for querying the exception's information before it is raised to the client.

```
public void receive_exception(ClientRequestInfo ri) throws
ForwardRequest {
    ...
}
```

### The void receive\_other(ClientRequestInfo ri) method

receive\_other—provides an interception point for querying information when a request results in something other than a normal reply or an exception. For example, a request could result in a retry (for example, a GIOP Reply with a LOCATION\_FORWARD status was received); or on asynchronous calls, the reply does not immediately follow the request. However, the control is returned to the client and an ending interception point is called.

```
public void receive_other(ClientRequestInfo ri) throws
ForwardRequest {
    ...
}
```

The complete implementation of the client-side request interceptor follows.

```
// SampleClientInterceptor.java

import org.omg.PortableInterceptor.*;
import org.omg.Dynamic.*;

public class SampleClientInterceptor extends org.omg.CORBA.LocalObject
implements ClientRequestInterceptor {

    public SampleClientInterceptor() {
        this("SampleClientInterceptor");
    }

    public SampleClientInterceptor(String name) {
        _name = name;
    }
    private String _name = null;
}
```

```

/**
 * InterceptorOperations implementation
 */
public String name() {
    return _name;
}

public void destroy() {
    System.out.println("=====>SampleServerLoader: Interceptors unloaded");
}

/**
 * ClientRequestInterceptor implementation
 */

/**
 * This is similar to VisiBroker 4.x ClientRequestInterceptor,
 *
 * public void preinvoke_premarshal(org.omg.CORBA.Object target,
 *     String operation,
 *     ServiceContextListHolder service_contexts_holder, Closure
 *     closure);
 */

public void send_request(ClientRequestInfo ri) throws ForwardRequest {
    System.out.println("=====> SampleClientInterceptor id " +
        ri.request_id() +
        " send_request => " + ri.operation() +
        ": target = " + ri.target());
}

/**
 * There is no equivalent interface for VisiBroker 4.x
 * ClientRequestInterceptor.
 */
public void send_poll(ClientRequestInfo ri) {
    System.out.println("=====> SampleClientInterceptor id " +
        ri.request_id() +
        " send_poll => " + ri.operation() +
        ": target = " + ri.target());
}

/**
 * This is similar to VisiBroker 4.x ClientRequestInterceptor,
 *
 * public void postinvoke(org.omg.CORBA.Object target,
 *     ServiceContext[] service_contexts, InputStream payload,
 *     org.omg.CORBA.Environment env, Closure closure);
 *
 * with env not holding any exception value.
 */
public void receive_reply(ClientRequestInfo ri) {
    System.out.println("=====> SampleClientInterceptor id " +
        ri.request_id() +
        " receive_reply => " + ri.operation());
}

/**
 * This is similar to VisiBroker 4.x ClientRequestInterceptor,
 *

```

Example: client\_server

```
* public void postinvoke(org.omg.CORBA.Object target,
*   ServiceContext[] service_contexts, InputStream payload,
*   org.omg.CORBA.Environment env, Closure closure);
*
* with env holding the exception value.
*/
public void receive_exception(ClientRequestInfo ri) throws ForwardRequest {
    System.out.println("=====> SampleClientInterceptor id " +
        ri.request_id() +
        " receive_exception => " + ri.operation() +
        ": exception = " + ri.received_exception());
}

/**
* This is similar to VisiBroker 4.x ClientRequestInterceptor,
*
* public void postinvoke(org.omg.CORBA.Object target,
*   ServiceContext[] service_contexts, InputStream payload,
*   org.omg.CORBA.Environment env, Closure closure);
*
* with env holding the exception value.
*/
public void receive_other(ClientRequestInfo ri) throws ForwardRequest {
    System.out.println("=====> SampleClientInterceptor id " +
        ri.request_id() +
        " receive_reply => " + ri.operation() +
        ": exception = " + ri.received_exception() +
        ", reply status = "+ getReplyStatus(ri));
}

protected String getReplyStatus(RequestInfo ri) {
    switch(ri.reply_status()) {
        case SUCCESSFUL.value:
            return "SUCCESSFUL";
        case SYSTEM_EXCEPTION.value:
            return "SYSTEM_EXCEPTION";
        case USER_EXCEPTION.value:
            return "USER_EXCEPTION";
        case LOCATION_FORWARD.value:
            return "LOCATION_FORWARD";
        case TRANSPORT_RETRY.value:
            return "TRANSPORT_RETRY";
        default:
            return "invalid reply status id";
    }
}
}
```

## Implementing the ServerRequestInterceptor for Server

On the server-side interceptor, the following request interceptor points will be triggered in relation to its events:

- `receive_request_service_contexts()`
- `receive_request()`
- `send_reply()`



- `send_exception()`
- `send_other()`

### The void `receive_request_service_contexts` (`ServerRequestInfo ri`) method

```
public void
receive_request_service_contexts(ServerRequestInfo ri)
throws ForwardRequest {
    ...
}
```

`receive_request_service_contexts`—provides an interception point for getting service context information from the incoming request and transferring it to `PortableInterceptor::Current` slot. This interception point is called before the Servant Manager. For more information, see [“Using servants and servant managers”](#).

### The void `receive_request` (`ServerRequestInfo ri`) method

`receive_request`—provides an interception point for querying all the information, including operation parameters.

```
public void receive_request(ServerRequestInfo ri) throws
ForwardRequest {
    ...
}
```

### The void `send_reply` (`ServerRequestInfo ri`) method

```
public void send_reply(ServerRequestInfo ri) {
    ...
}
```

`send_reply`—provides an interception point for querying reply information and modifying the reply service context after the target operation has been invoked and before the reply is returned to the client.

### The void `send_exception` (`ServerRequestInfo ri`) method

```
public void send_exception(ServerRequestInfo ri) throws
ForwardRequest {
    ...
}
```

`send_exception`—provides an interception point for querying the exception information and modifying the reply service context before the exception is raised to the client.

### The void `send_other` (`ServerRequestInfo ri`) method

```
public void send_other(ServerRequestInfo ri) throws
ForwardRequest {
    ...
}
```

`send_other`—provides an interception point for querying the information available when a request results in something other than a normal reply or an exception. For example, a request could result in a retry (such as, a GIOP Reply with a `LOCATION_FORWARD` status was received); or, on asynchronous calls, the reply does not immediately follow the request, but control is returned to the client and an ending interception point is called.

Example: client\_server

All the interception points allow both the client and server to obtain different types of information at different points of an invocation. In the example, this information is displayed as a debugging tool.

The following code example shows the complete implementation of the server-side request interceptor:

```
// SampleServerInterceptor.java

import org.omg.PortableInterceptor.*;
import org.omg.Dynamic.*;
import java.io.PrintStream;

public class SampleServerInterceptor extends org.omg.CORBA.LocalObject
implements ServerRequestInterceptor {

    private String _name = null;

    public SampleServerInterceptor() {
        this("SampleServerInterceptor");
    }

    public SampleServerInterceptor(String name) {
        _name = name;
    }
/**
 * InterceptorOperations implementation
 */
public String name() {
    return _name;
}

public void destroy() {
    System.out.println("=====>SampleServerLoader: Interceptors unloaded");
}

/**
 * ServerRequestInterceptor implementation
 */

/**
 * This is similar to VisiBroker 4.x ServerRequestInterceptor,
 *
 * public void preinvoke(org.omg.CORBA.Object target, String operation,
 *   ServiceContext[] service_contexts, InputStream payload, Closure
 * closure);
 */

public void receive_request_service_contexts(ServerRequestInfo ri)
    throws ForwardRequest {
    System.out.println("=====> SampleServerInterceptor id " + ri.request_id()
+
        " receive_request_service_contexts => " + ri.operation());
}

/**
 * There is no equivalent interface for VisiBroker 4.x
 * SeverRequestInterceptor.
 */
public void receive_request(ServerRequestInfo ri)
```

```

        throws ForwardRequest {
    System.out.println("=====> SampleServerInterceptor id " + ri.request_id()
+
        " receive_request =>" + ri.operation() +
        ": object id = " + ri.object_id() +
        ", adapter_id = " + ri.adapter_id());
    }

/**
 * There is no equivalent interface for VisiBroker 4.x
 * ServerRequestInterceptor.
 */
public void send_reply(ServerRequestInfo ri) {
    System.out.println("=====> SampleServerInterceptor id " + ri.request_id()
+
        " send_reply =>" + ri.operation());
}

/**
 * This is similar to VisiBroker 4.x ServerRequestInterceptor,
 *
 * public void postinvoke_premarshal(org.omg.CORBA.Object target,
 *     ServiceContextListHolder service_contexts_holder,
 *     org.omg.CORBA.Environment env, Closure closure);
 *
 * with env holding the exception value.
 */
public void send_exception(ServerRequestInfo ri)
    throws ForwardRequest {
    System.out.println("=====> SampleServerInterceptor id " + ri.request_id()
+
        " send_exception =>" + ri.operation() +
        ": exception = " + ri.sending_exception() +
        ", reply status = " + getReplyStatus(ri));
}

/**
 * This is similar to VisiBroker 4.x ServerRequestInterceptor,
 *
 * public void postinvoke_premarshal(org.omg.CORBA.Object target,
 *     ServiceContextListHolder service_contexts_holder,
 *     org.omg.CORBA.Environment env, Closure closure);
 *
 * with env holding the exception value.
 */
public void send_other(ServerRequestInfo ri) throws ForwardRequest {
    System.out.print("=====> SampleServerInterceptor id " +
ri.request_id() +
        " send_other =>" + ri.operation() +
        ": exception = " + ri.sending_exception() +
        ", reply status = " + getReplyStatus(ri));
}

protected String getReplyStatus(RequestInfo ri) {
    switch(ri.reply_status()) {
        case SUCCESSFUL.value:
            return "SUCCESSFUL";
        case SYSTEM_EXCEPTION.value:
            return "SYSTEM_EXCEPTION";
        case USER_EXCEPTION.value:

```

Example: client\_server

```
        return "USER_EXCEPTION";
    case LOCATION_FORWARD.value:
        return "LOCATION_FORWARD";
    case TRANSPORT_RETRY.value:
        return "TRANSPORT_RETRY";
    default:
        return "invalid reply status id";
    }
}
}
```

## Developing the Client and Server Application

After the interceptor classes are written, you need to register them with their respective client and server applications.

The OMG specification has been strictly followed to implement the mappings of `register_orb_initializer`, which is registered using Java ORB properties. In the example, the client and server applications actually read the property files, `client.properties`, and `server.properties` containing the property

```
org.omg.PortableInterceptor.ORBInitializerClass.<Service>
```

where `<Service>` is the string name of a class which implements `org.omg.PortableInterceptor.ORBInitializer`. In this case, the two classes are `SampleClientLoader` and `SampleServerLoader`.

If you choose to write your application without reading any properties from a file, you can also use the command line option. To do so, run the application with the following parameters:

```
vbj -Dorg.omg.PortableInterceptor.ORBInitializerClass.SampleClientLoader=
SampleClientLoader Client
vbj -Dorg.omg.PortableInterceptor.ORBInitializerClass.SampleServerLoader=
SampleServerLoader Server
```

## Implementing the client application

```
// Client.java

import org.omg.PortableServer.*;

import java.util.Properties;
import java.io.FileInputStream;

public class Client {

    private static Properties property = null;

    public static void main(String[] args) {
        try {
            property = new Properties();
            property.load(new FileInputStream("client.properties"));

            // Initialize the ORB.
            org.omg.CORBA.ORB orb=org.omg.CORBA.ORB.init(args, property);
            // Get the manager Id
            byte[] AccountManagerId="BankManager".getBytes();
            // Locate an account manager. Give the full POA name and servant ID.
            Bank.AccountManager manager =
                Bank.AccountManagerHelper.bind(orb, "/bank_client_server_poa",
```

```
        AccountManagerId);
// use args[0] as the account name, or a default.
String name = null;
name = args.length > 0 ? args[0] : "Jack B. Quick";
// Request the account manager to open a named account.
Bank.Account account = manager.open(name);
// Get the balance of the account.
float balance = account.balance();
// Print out the balance.
System.out.println("The balance in " + name + "'s account is $" +
    balance);
    }
    catch(Exception e) {
        e.printStackTrace();
    }
}
}
```

## Implementing the server application

```

// Server.java

import org.omg.PortableServer.*;
import java.util.Properties;
import java.io.FileInputStream;

public class Server {

    private static Properties property = null;

    public static void main(String[] args) {
        try {
            property = new Properties();
            property.load(new
FileInputStream("server.properties"));

            // Initialize the ORB.
            org.omg.CORBA.ORB orb = org.omg.CORBA.ORB.init(args,
property);
            // get a reference to the root POA
            POA rootPoa =
POAHelper.narrow(orb.resolve_initial_references("RootPOA")
);

            // Create policies for our persistent POA
            org.omg.CORBA.Policy[] policies = {

rootPoa.create_lifespan_policy(LifespanPolicyValue.PERSIST
ENT)
            };

            // Create myPOA with the right policies
            POA myPOA =
rootPoa.create_POA("bank_client_server_poa",
                    rootPoa.the_POAManager(), policies
);

            // Create Account servants
            AccountManagerImpl managerServant = new
AccountManagerImpl();
            byte[] managerId = "BankManager".getBytes();
            myPOA.activate_object_with_id(managerId,
managerServant);
            rootPoa.the_POAManager().activate();

            //Announce Servants are ready

System.out.println(myPOA.servant_to_reference(managerServa
nt) + " is
                ready.");
            // Wait for incoming requests
            orb.run();
        }
        catch (Exception e) {
            e.printStackTrace();
        }
    }
}

```

## Compilation procedure

To compile the Java example, execute the following command:

### Windows

```
<install_dir>\examples\vbroker\pi\client_server> vbmake
```

or double-click the batch file icon if the environment variable, <install\_dir>\bin, has already been added to the environment variable, PATH).

### UNIX

```
<install_dir>/examples/vbroker/pi/client_server> make -f  
Makefile.java
```

## Execution or deployment of Client and Server Applications

To run the Java example with Portable Interceptor installed, start the Server and Client as follows:

### Windows

Open two console windows:

```
<install_dir>\examples\vbroker\pi\client_server> start vbj  
Server (running under a new command prompt window)  
<install_dir>\examples\vbroker\pi\client_server> vbj  
Client John (using a given name)
```

or

```
<install_dir>\examples\vbroker\pi\client_server> vbj  
Client(using the default name)
```

### UNIX

Open two console shells:

```
<install_dir>/examples/vbroker/pi/client_server> vbj  
Server(in the first window)  
<install_dir>/examples/vbroker/pi/client_server> vbj  
Client John (in the second window, using a given name)
```

or

```
<install_dir>/examples/vbroker/pi/client_server> vbj  
Client (in the second window, using the default name)
```





# Using VisiBroker Interceptors

This section provides an overview of the VisiBroker Interceptors (Interceptors) framework, walks through a Interceptor example, and describes some advanced features such as Interceptor factories and chaining Interceptors. This section also covers the expected behaviors when both Portable Interceptors and VisiBroker Interceptors are used in the same service.

## Interceptors overview

Similar to Portable Interceptors, VisiBroker Interceptors offers VisiBroker ORB services a mechanism to intercept normal flow of execution of the ORB. There are two kinds of VisiBroker Interceptors:

- *Client Interceptors* are system-level Interceptors which are called when a method is invoked on a client object.
- *Server Interceptors* are system-level Interceptors which are called when a method is invoked on a server object.

To use VisiBroker Interceptors, you declare a class which implements one of the Interceptor interfaces. Once you have instantiated an Interceptor object, you register it with its corresponding Interceptor manager. Your Interceptor object is then notified by its manager when, for example, an object has had one of its methods invoked or its parameters marshaled or demarshaled.

An important difference between VisiBroker interceptors and Portable interceptors is that VisiBroker interceptors do not get invoked for co-located calls. Therefore, users have to make a cautious decision when choosing which interceptor to use.

### Note

If you want to intercept an operation request before it is marshal on the client side or if you want to intercept an operation request before it is processed on the server side, use object wrappers, described in [“Using object wrappers”](#).

## Interceptor interfaces and managers

Interceptor developers derive classes from one or more of the following base Interceptor API classes which are defined and implemented by the VisiBroker.

- Client Interceptors:
  - BindInterceptor
  - ClientRequestInterceptor
- Server Interceptors:
  - POALifeCycleInterceptor
  - ActiveObjectLifeCycleInterceptor
  - ServerRequestInterceptor
  - IORCreationInterceptor
- ServiceResolver Interceptor

### Client Interceptors

There are currently two kinds of client Interceptor and their respective managers:

- BindInterceptor and BindInterceptorManager
- ClientRequestInterceptor and ClientRequestInterceptorManager

For more details about client Interceptors, see [“Using Portable Interceptors”](#).

### BindInterceptor

A BindInterceptor object is a global Interceptor which is called on the client side before and after binds.

```
package com.inprise.vbroker.InterceptorExt;
public interface BindInterceptor {
    public IORValue bind(IORValue ior,
        org.omg.CORBA.Object target,
        boolean rebind,
        Closure closure);
    public IORValue bind_failed(IORValue ior,
        org.omg.CORBA.Object target,
        Closure closure);
    public void bind_succeeded(IORValue ior,
        org.omg.CORBA.Object target,
        int Index,
        InterceptorManagerControl control,
        Closure closure);
    public void exception_occurred(IORValue ior,
        org.omg.CORBA.Object target,
        org.omg.CORBA.Environment env,
        Closure closure);
}
```

### ClientRequestInterceptor

A ClientRequestInterceptor object may be registered during a bind\_succeeded call of a BindInterceptor object, and it remains active

for the duration of the connection. Two of its methods are called before the invocation on the client object, one (`preinvoke_premarshal`) before the parameters are marshaled and the other (`preinvoke_postmarshal`) after they are. The third method (`postinvoke`) is called after the request has completed.

```
package com.inprise.vbroker.InterceptorExt;
public interface ClientRequestInterceptor {
    public void preinvoke_premarshal(org.omg.CORBA.Object
target,
    String operation,
    ServiceContextListHolder service_contexts_holder,
    Closure closure);
    public void preinvoke_postmarshal(org.omg.CORBA.Object
target,
    OutputStream payload,
    Closure closure);
    public void postinvoke(org.omg.CORBA.Object target,
    ServiceContext[] service_contexts,
    InputStream payload,
    org.omg.CORBA.Environment env,
    Closure closure);
    public void exception_occurred(org.omg.CORBA.Object
target,
    org.omg.CORBA.Environment env,
    Closure closure);
}
```

## Server Interceptors

There are the following kinds of server Interceptors:

- `POALifeCycleInterceptor` and `POALifeCycleInterceptorManager`
- `ActiveObjectLifeCycleInterceptor` and `ActiveObjectLifeCycleInterceptorManager`
- `ServerRequestInterceptor` and `ServerRequestInterceptorManager`
- `IORCreationInterceptor` and `IORCreationInterceptorManager`

For more details about server Interceptors see [“Using Portable Interceptors”](#).

### POALifeCycleInterceptor

A `POALifeCycleInterceptor` object is a global Interceptor which is called every time a POA is created (using the `create` method) or destroyed (using the `destroy` method).

```
package com.inprise.vbroker.InterceptorExt;
public interface POALifeCycleInterceptor {
    public void create(org.omg.PortableServer.POA poa,
    org.omg.CORBA.PolicyListHolder policies_holder,
    IORValueHolder iorTemplate,
    InterceptorManagerControl control) ;
    public void destroy(org.omg.PortableServer.POA poa);
}
```

## ActiveObjectLifeCycleInterceptor

An `ActiveObjectLifeCycleInterceptor` object is called whenever an object is added to the Active Object Map (using the `create` method) or after an object has been deactivated and etherealized (using the `destroy` method). The Interceptor may be registered by a `POALifeCycleInterceptor` on a per-POA basis at POA creation time. This Interceptor may only be registered if the POA has the `RETAIN` policy.

```
package com.inprise.vbroker.InterceptorExt;
public interface ActiveObjectLifeCycleInterceptor {
    public void create(byte[] oid,
        org.omg.PortableServer.Servant servant,
        org.omg.PortableServer.POA adapter);
    public void destroy (byte[] oid,
        org.omg.PortableServer.Servant servant,
        org.omg.PortableServer.POA adapter);
}
```

## ServerRequestInterceptor

A `ServerRequestInterceptor` object is called at various stages in the invocation of a server implementation of a remote object before the invocation (using the `preinvoke` method) and after the invocation both before and after the marshaling of the reply (using the `postinvoke_premarshal` and `postinvoke_postmarshal` methods respectively). This Interceptor may be registered by a `POALifeCycleInterceptor` object at POA creation time on a per-POA basis.

```
package com.inprise.vbroker.InterceptorExt;
public interface ServerRequestInterceptor {
    public void preinvoke(org.omg.CORBA.Object target,
        String operation,
        ServiceContext[] service_contexts,
        InputStream payload,
        Closure closure);
    public void postinvoke_premarshal(org.omg.CORBA.Object
target,
        ServiceContextListHolder service_contexts_holder,
        org.omg.CORBA.Environment env,
        Closure closure);
    public void postinvoke_postmarshal(org.omg.CORBA.Object
target,
        OutputStream payload,
        Closure closure);
    public void exception_occurred(org.omg.CORBA.Object
target,
        org.omg.CORBA.Environment env,
        Closure closure);
}
```

### Note

If an `org.omg.CORBA.SystemException` or any sub-classes (for example `org.omg.CORBA.NO_PERMISSION`) is raised on the server side, the exception should not be encrypted. This is because the ORB uses some of these exceptions internally (for example `TRANSIENT` for doing automatic rebind).

## IORCreationInterceptor

An IORCreationInterceptor object is called whenever a POA creates an object reference (using the create method). This Interceptor may be registered by a POALifeCycleInterceptor at POA creation time on a per-POA basis.

```
package com.inprise.vbroker.InterceptorExt;
public interface IORCreationInterceptor {
    public void create(org.omg.PortableServer.POA poa,
        IORValueHolder ior);
}
```

## Service Resolver Interceptor

This Interceptor is used to install a user service that you can then dynamically load.

```
public interface ServiceResolverInterceptor {
    public org.omg.CORBA.Object resolve (java.lang.String
name):
}
public interface ServiceResolverInterceptorManager extends
com.inprise.vbroker.interceptor.InterceptorManager {
    public void add (java.lang.String name,

com.inprise.vbroker.interceptor.ServiceResolverInterceptor
\interceptor) ;
    public void remove (java.lang.String name):
}
```

When you call `resolve_initial_references`, the `resolve` on all installed services gets called. The `resolve` then can return the appropriate object.

To write service initializers, you must obtain a `ServiceResolver` after getting an `InterceptorManagerControl` to be able to add your services.

## Default Interceptor classes

VisiBroker provides default Interceptor Java classes that you can extend and implement. These default Interceptor classes offer the same methods as the Interceptor interfaces; however, when you extend the default Interceptor class, you can choose which methods to implement or override. When you use these classes, you can accept the default behavior that they provide or change it.

- DefaultBindInterceptor class
- DefaultClientInterceptor class
- DefaultServerInterceptor class

## Registering Interceptors with the VisiBroker ORB

Each Interceptor interface has a corresponding Interceptor manager interface which is used to register your Interceptor objects with the VisiBroker ORB. The following steps are necessary to register an Interceptor:

- 1 Get a reference to an `InterceptorManagerControl` object by calling the `resolve_initial_references` method on an ORB object with the parameter `VisiBrokerInterceptorControl`.
- 2 Call the `get_manager` method on the `InterceptorManagerControl` object with one of the String values in the following table which shows the String values to pass to the `get_manager` method of the `InterceptorManagerControl` object. (Be sure to cast the object reference to its corresponding Interceptor manager interface.)

Value	Corresponding Interceptor interface
<code>ClientRequest</code>	<code>ClientRequestInterceptor</code>
<code>Bind</code>	<code>BindInterceptor</code>
<code>POALifeCycle</code>	<code>POALifeCycleInterceptor</code>
<code>ActiveObjectLifeCycle</code>	<code>ActiveObjectLifeCycleInterceptor</code>
<code>ServerRequest</code>	<code>ServerRequestInterceptor</code>
<code>IORCreation</code>	<code>IORCreationInterceptor</code>
<code>ServiceResolver</code>	<code>ServiceResolverInterceptor</code>

- 3 Create an instance of your Interceptor.
- 4 Register your Interceptor object with the manager object by calling the `add` method.
- 5 Load your Interceptor objects when running your client and server programs.

## Creating Interceptor objects

Finally, you need to implement a factory class which creates instances of your Interceptors and registers them with the `VisiBroker` ORB. Your factory class must or implement the `ServiceLoader` interface.

```
package com.inprise.vbroker.interceptor;
public interface ServiceLoader {
    // This method is called by the ORB when ORB.init() is
    // called.
    public abstract void init(org.omg.CORBA.ORB orb);
    // Called after ORB.init() is done but control hasn't
    // been returned to
    // the user. Can be used to disable certain resources
    // that were only
    // made available to other service inits.
    public abstract void init_complete(org.omg.CORBA.ORB
orb);
    // Called when the orb is being shutdown.
    public abstract void shutdown(org.omg.CORBA.ORB orb);
}
```

### Note

You can also create new instances of your Interceptors and register them with the `VisiBroker` ORB from within other Interceptors as in the examples in [“Example Interceptors”](#).

## Loading Interceptors

To load your Interceptor, you must set the `vbroker.orb.dynamicLibs` property. This property can be set either in the properties file (see [“Using](#)

[VisiBroker Interceptors](#)) or be passed into the VisiBroker ORB using the `-D` option.

## Example Interceptors

The example Interceptor in this section uses all of the Interceptor API methods (listed in [“Using Portable Interceptors”](#)) so that you can see how these methods are used, and when they are invoked.

### Example code

In [“Code listings”](#), each of the Interceptor API methods is simply implemented to print informational messages to the standard output.

The following example applications are located in the directory:

```
<install_dir>\examples\vbroker\interceptors\
```

- active\_object\_lifecycle
- client\_server
- ior\_creation
- encryption

### Client-server Interceptors example

To run the example, compile the files as you normally would. Then start up the server and the client as follows:

```
prompt>vbj -Dvbroker.orb.dynamicLibs=SampleServerLoader
Server
prompt>vbj -Dvbroker.orb.dynamicLibs=SampleClientLoader
Client John
```

You specify as VisiBroker ORB services the two classes which implement the `ServiceLoader` interface.

### Note

The `ServiceInit` class used in VisiBroker 3.x is replaced by implementing two interfaces: `ServiceLoader` and `ServiceResolverInterceptor`. For an example of how to do this, see [“ServiceResolverInterceptor example”](#).

The results of executing the example Interceptor are shown in the following table. The execution by the client and server is listed in sequence.

Client	Server
	<pre> =====&gt;SampleServerLoader: Interceptors loaded=====&gt; In POA /. Nothing to do.=====&gt; In POA bank_agent_poa, 1 ServerRequest interceptor installedStub [repository_id=IDL:Bank/AccountManager: 1.0,key=ServiceId[service=/bank_agent_poa,id= {11 bytes: [B] [a] [n] [k] [M] [a] [n] [a] [g] [e] [r] }]] is ready. </pre>
<pre> Bind Interceptors loaded=====&gt; SampleBindInterceptor bind=====&gt; SampleBindInterceptor bind_succeeded=====&gt; SampleClientInterceptor id MyClientInterceptor preinvoke_premarshal=&gt; open=====&gt; SampleClientInterceptor id MyClientInterceptor preinvoke_postmarshal </pre>	<pre> =====&gt; SampleServerInterceptor id MyServerInterceptor preinvoke =&gt; openCreated john's account: Stub[repository_id=IDL:Bank/Account:1.0, key=TransientId[poaName=/,id={4 bytes: (0) (0) (0) (0)}, sec=0,usec=0]] </pre>
<pre> =====&gt; SampleClientInterceptor id MyClientInterceptor postinvoke=====&gt; SampleBindInterceptor bind=====&gt; SampleBindInterceptor bind_succeeded=====&gt; SampleClientInterceptor id MyClientInterceptor preinvoke_premarshal =&gt; balance =====&gt; SampleClientInterceptor id MyClientInterceptor preinvoke_postmarshal </pre>	<pre> =====&gt; SampleServerInterceptor id MyServerInterceptor postinvoke_premarshal=====&gt; SampleServerInterceptor id MyServerInterceptor postinvoke_postmarshal </pre>
<pre> =====&gt; SampleClientInterceptor id MyClientInterceptor postinvoke The balance in john's account is \$245.64 </pre>	

Since the OAD is not running, the bind call fails and the server proceeds. The client binds to the account object, and then calls the balance method. This request is received by the server, processed, and results are returned to the client. The client prints the results.

As demonstrated by the example code and results, the Interceptors for both the client and server are installed when the respective process starts. Information about registering an interceptor is covered in [“Registering Interceptors with the VisiBroker ORB”](#).

### ServiceResolverInterceptor example

The following code provides an example of how to implement a `ServiceLoader` interface:

```

import com.inprise.vbroker.properties.*;
import com.inprise.vbroker.interceptor.*;
import com.inprise.vbroker.InterceptorExt.*;

public final class UtilityServiceLoader implements

```



```

ServiceLoader,
ServiceResolverInterceptor {
    private com.inprise.vbroker.orb.ORB _orb = null;
    private String[] _serviceNames = { "TimeService",
    "WeatherService"};

    public void init(org.omg.CORBA.ORB orb) {
        // Just in case they are needed by resolve()
        _orb = (com.inprise.vbroker.orb.ORB) orb;

        PropertyManager pm = _orb.getPropertyManager();
        // use the PropertyManager to query property
settings
        // if needed (not used in this example)

        /**** Installing the Initial Reference *****/
        InterceptorManagerControl control =
        _orb.interceptorManager();
        ServiceResolverInterceptorManager manager =

        (ServiceResolverInterceptorManager) control.get_manager("Se
        rviceResolver");
        for (int i = 0; i < _serviceNames.length; i++) {
            manager.add(_serviceNames[i], this);
        }
        /**** end of installation ****/

        if (_orb.debug)
            _orb.println("UtilityServices package has been
initialized");
    }

    public void init_complete(org.omg.CORBA.ORB orb) {
        // can be used for post-initialization processing if
desired
    }

    public void shutdown(org.omg.CORBA.ORB orb) {
        _orb = null;
        _serviceNames = null;
    }

    public org.omg.CORBA.Object resolve(java.lang.String
service) {
        org.omg.CORBA.Object srv = null;
        byte[] serviceId = service.getBytes();
        try {
            if (service == "TimeService") {
                srv =
UtilityServices.TimeServiceHelper.bind(_orb, "/"
time_service_poa", serviceId);
            }
            else if (service == "WeatherService") {
                srv =
UtilityServices.WeatherServiceHelper.bind(_orb, "/"
weather_service_poa",
                serviceId);
            }
        } catch (org.omg.CORBA.SystemException e) {
            if (_orb.debug)
                _orb.println("UtilityServices package resolve
error: " + e);
            srv = null;
        }
    }
}

```

```

        return srv;
    }
}

```

## Code listings

### SampleServerLoader

The `SampleServerLoader` object is responsible for loading the `POALifeCycleInterceptor` class and instantiating an object. This class is linked to the VisiBroker ORB dynamically by `vbroker.orb.dynamicLibs`. The `SampleServerLoader` class contains the `init` method which is called by the VisiBroker ORB during initialization. Its sole purpose is to install a `POALifeCycleInterceptor` object by creating it and registering it with the `InterceptorManager`.

```

import java.util.*;
import com.inprise.vbroker.orb.*;
import com.inprise.vbroker.interceptor.*;
import com.inprise.vbroker.PortableServerExt.*;
public class SampleServerLoader implements ServiceLoader {
    public void init(org.omg.CORBA.ORB orb) {
        try {
            InterceptorManagerControl control =
                InterceptorManagerControlHelper.narrow(

orb.resolve_initial_references("VisiBrokerInterceptorContr
ol"));
            // Install a POA interceptor
            POALifeCycleInterceptorManager poa_manager =
                (POALifeCycleInterceptorManager)
control.get_manager("POALifeCycle");
            poa_manager.add(new
SamplePOALifeCycleInterceptor());
        } catch(Exception e) {
            e.printStackTrace();
            throw new org.omg.CORBA.INITIALIZE(e.toString());
        }

System.out.println("=====>SampleServerLoader:Interc
eptors loaded");
    }
    public void init_complete(org.omg.CORBA.ORB orb) {
    }
    public void shutdown(org.omg.CORBA.ORB orb) {
    }
}

```

## SamplePOALifeCycleInterceptor

The `SamplePOALifeCycleInterceptor` object is invoked every time a POA is created or destroyed. Because we have two POAs in the `client_server` example, this Interceptor is invoked twice, first during `rootPoa` creation and then at the creation of `myPOA`. We install the `SampleServerInterceptor` only at the creation of `myPOA`.

```
import com.inprise.vbroker.interceptor.*;
import com.inprise.vbroker.PortableServerExt.*;
import com.inprise.vbroker.IOP.*;
public class SamplePOALifeCycleInterceptor implements
POALifeCycleInterceptor {
    public void create(org.omg.PortableServer.POA poa,
        org.omg.CORBA.PolicyListHolder policies_holder,
        IORValueHolder iorTemplate,
        InterceptorManagerControl control) {
        if(poa.the_name().equals("bank_agent_poa")) {
            // Add the Request-level interceptor
            SampleServerInterceptor interceptor =
                new
SampleServerInterceptor("MyServerInterceptor");
            // Get the IORCreation interceptor manager
            ServerRequestInterceptorManager manager =

(ServerRequestInterceptorManager) control.get_manager
("ServerRequest");
            // Add the interceptor
            manager.add(interceptor);
            System.out.println("=====>In POA " +
poa.the_name() +
                ", 1 ServerRequest interceptor installed");
        } else
            System.out.println("=====>In POA " +
poa.the_name
                () + ". Nothing to do.");
        }
    public void destroy(org.omg.PortableServer.POA poa) {
        // To be a trace!
        System.out.println("=====>
SamplePOALifeCycleInterceptor
        destroy");
    }
}
```

## SampleServerInterceptor

The `SampleServerInterceptor` object is invoked every time a request is received at or a reply is made by the server.

```
import com.inprise.vbroker.interceptor.*;
import com.inprise.vbroker.IOP.*;
import com.inprise.vbroker.CORBA.portable.*;
public class SampleServerInterceptor implements
ServerRequestInterceptor {
    private String _id;
    public SampleServerInterceptor(String id) {
        _id = id;
    }
    public void preinvoke(org.omg.CORBA.Object target,
        String operation,
        ServiceContext[] service_contexts,
        InputStream payload,
        Closure closure) {
        // Put the _id of this ServerRequestInterceptor into
the closure object
        closure.object = new String(_id);
        System.out.println("=====>
SampleServerInterceptor id " +
            closure.object + " preinvoke => " +
operation);
    }
    public void postinvoke_premarshal(org.omg.CORBA.Object
target,
        ServiceContextListHolder service_contexts_holder,
        org.omg.CORBA.Environment env,
        Closure closure) {
        System.out.println("=====>
SampleServerInterceptor id " +
            closure.object + " postinvoke_premarshal");
    }
    public void postinvoke_postmarshal(org.omg.CORBA.Object
target,
        OutputStream payload,
        Closure closure) {
        System.out.println("=====>
SampleServerInterceptor id " +
            closure.object + " postinvoke_postmarshal");
    }
    public void exception_occurred(org.omg.CORBA.Object
target,
        org.omg.CORBA.Environment env,
        Closure closure) {
        System.out.println("=====>
SampleServerInterceptor id " +
            closure.object + " exception_occurred");
    }
}
```

## SampleClientInterceptor

The `SampleClientInterceptor` is invoked every time a request is made by or a reply is received at the client.

```
import com.inprise.vbroker.interceptor.*;
import com.inprise.vbroker.IOP.*;
import com.inprise.vbroker.CORBA.portable.*;
public class SampleClientInterceptor implements
ClientRequestInterceptor {
    private String _id;
    public SampleClientInterceptor(String id) {
        _id = id;
    }
    public void preinvoke_premarshal(org.omg.CORBA.Object
target,
    String operation,
    ServiceContextListHolder service_contexts_holder,
    Closure closure) {
        // Put the _id of this ClientRequestInterceptor into
the closure object
        closure.object = new String(_id);
        System.out.println("=====>
SampleClientInterceptor id " +
            closure.object +
            " preinvoke_premarshal => " + operation);
    }
    public void preinvoke_postmarshal(org.omg.CORBA.Object
target,
    OutputStream payload,
    Closure closure) {
        System.out.println("=====>
SampleClientInterceptor id " +
            closure.object + " preinvoke_postmarshal");
    }
    public void postinvoke(org.omg.CORBA.Object target,
    ServiceContext[] service_contexts,
    InputStream payload,
    org.omg.CORBA.Environment env,
    Closure closure) {
        System.out.println("=====>
SampleClientInterceptor id " +
            closure.object + " postinvoke");
    }
    public void exception_occurred(org.omg.CORBA.Object
target,
    org.omg.CORBA.Environment env,
    Closure closure) {
        System.out.println("=====>
SampleClientInterceptor id " +
            closure.object + " exception_occurred");
    }
}
```

## SampleClientLoader

The `SampleClientLoader` is responsible for loading `BindInterceptor` objects. This class is linked to the VisiBroker ORB dynamically by `vbroker.orb.dynamicLibs`. The `SampleClientLoader` class contains the `bind` and `bind_succeeded` methods. These methods are called by the ORB during object binding. When the `bind` succeeds, `bind_succeeded` will be called by the ORB and a `BindInterceptor` object is installed by creating it and registering it the `InterceptorManager`.

```
import java.util.*;
import com.inprise.vbroker.orb.*;
import com.inprise.vbroker.interceptor.*;
import com.inprise.vbroker.PortableServerExt.*;
public class SampleClientLoader implements ServiceLoader {
    public void init(org.omg.CORBA.ORB orb) {
        try {
            InterceptorManagerControl control =
                InterceptorManagerControlHelper.narrow(

orb.resolve_initial_references("VisiBrokerInterceptorContr
ol"));
            BindInterceptorManager bind_manager =
                (BindInterceptorManager)
control.get_manager("Bind");
            bind_manager.add(new SampleBindInterceptor());
        } catch(Exception e) {
            e.printStackTrace();
            throw new org.omg.CORBA.INITIALIZE(e.toString());
        }
        System.out.println("Bind Interceptors loaded");
    }
    public void init_complete(org.omg.CORBA.ORB orb) {
    }
    public void shutdown(org.omg.CORBA.ORB orb) {
    }
}
}
```

## SampleBindInterceptor

The `SampleBindInterceptor` is invoked when the client attempts to bind to an object. The first step on the client side after ORB initialization is to bind to an `AccountManager` object. This bind invokes the `SampleBindInterceptor` and a `SampleClientInterceptor` is installed when the bind succeeds.

```
import com.inprise.vbroker.interceptor.*;
import com.inprise.vbroker.IOP.*;
public class SampleBindInterceptor implements
BindInterceptor {
    public IORValue bind(IORValue ior, org.omg.CORBA.Object
target,
        boolean rebind, Closure closure) {
        // To be a trace!
        System.out.println("=====>
SampleBindInterceptor bind");
        return null;
    }
    public IORValue bind_failed(IORValue ior,
org.omg.CORBA.Object target,
        Closure closure) {
        // To be a trace!
        System.out.println("=====>
SampleBindInterceptor bind_failed");
        return null;
    }
    public void bind_succeeded(IORValue ior,
org.omg.CORBA.Object target,
        int Index, InterceptorManagerControl control,
        Closure closure) {
        // To be a trace!
        System.out.println("=====>
SampleBindInterceptor bind_succeeded");
        // Create the Client Request interceptor:
        SampleClientInterceptor interceptor =
        new SampleClientInterceptor("MyClientInterceptor");
        // Get the manager
        ClientRequestInterceptorManager manager =
        (ClientRequestInterceptorManager) control.get_manager
("ClientRequest");
        // Add CRQ to the list:
        manager.add(interceptor);
    }
    public void exception_occurred(IORValue ior,
org.omg.CORBA.Object target,
        org.omg.CORBA.Environment env,
        Closure closure) {
        // To be a trace!
        System.out.println("=====> SampleBindInterceptor
exception_occured");
    }
}
```

## Passing information between your Interceptors

Closure objects are created by the ORB at the beginning of certain sequences of Interceptor calls. The same Closure object is used for all calls in that particular sequence. The Closure object contains a single public data field `object` of type `java.lang.Object` which may be set by the Interceptor to keep state information. The sequences for which Closure objects are created vary depending on the Interceptor type. In the `ClientRequestInterceptor`, a new Closure is created before calling `preinvoke_premarshal` and the same Closure is used for that request until the request completes, successfully or not. Likewise, in the `ServerInterceptor`, a new Closure is created before calling `preinvoke`, and that Closure is used for all Interceptor calls related to processing that particular request.

For an example of how Closure is used, see the examples in the following directory:

```
<install_dir>/examples/vbroker/interceptors/client_server
```

The Closure object can be cast to `ExtendedClosure` to obtain `response_expected` and `request_id` as follows:

```
int my_response_expected =
    ((ExtendedClosure)closure).reqInfo.response_expected;
int my_request_id =
    ((ExtendedClosure)closure).reqInfo.request_id;
```

## Using both Portable Interceptors and VisiBroker Interceptors simultaneously

Both Portable Interceptors and VisiBroker Interceptors can be installed simultaneously with the VisiBroker ORB. However, as they have different implementations, there are several rules of flow and constraints that developers need to understand when using both Interceptors, as described in the following.

### Order of invocation of interception points

The order of invocation of interception points follows the interception point ordering rules of individual versions of Interceptors, regardless of whether the developer actually chooses to install one of more than one version.

### Client side Interceptors

When both Portable Interceptors and VisiBroker client side Interceptors are installed, the order of events, (assuming no Interceptor throws an exception) is:

- 1 `send_request` (Portable Interceptor), followed by `preinvoke_premarshal` (Interceptors)
- 2 construct request message
- 3 `preinvoke_postmarshal` (Interceptor)
- 4 send request message and wait for reply
- 5 `postinvoke` (Interceptor), followed by `received_reply/receive_exception/receive_other` (Portable Interceptor) depending on the type of reply.



## Server side Interceptors

When both Portable Interceptors and VisiBroker server side Interceptors are installed, the order of events is received (locate requests do not fire Interceptors, which is the same as VisiBroker behavior), assuming no Interceptor throws an exception, is:

- 1 `received_request_service_contexts` (Portable Interceptor), followed by `preinvoke` (Interceptor)
- 2 `servantLocator.preinvoke` (if using servant locator)
- 3 `receive_request` (Portable Interceptor)
- 4 invoke operation on servant
- 5 `postinvoke_premarshal` (Interceptor)
- 6 `servantLocator.postinvoke` (if using servant locator)
- 7 `send_reply/send_exception/send_other`, depending on the outcome of the request
- 8 `postinvoke_postmarshal` (Interceptor)

## Order of ORB events during POA creation

The order of ORB events during creation of a POA is listed as follows:

- 1 An IOR template is created based on profiles of server engines servicing the POA.
- 2 An Interceptors' POA life cycle Interceptors' `create()` method is invoked. This method can potentially add new policies or modify the IOR template created in the previous step.
- 3 A Portable Interceptor's `IORInfo` object is created and the `IORInterceptors`' `establish_components()` method is invoked. This interception point allows the Interceptor to query the policies passed to `create_POA()` and those added in the previous step, and also add components to the IOR template based on those policies.
- 4 An object reference factory and object reference template for the POA are created, and the Portable Interceptor's `IORInterceptors`' `components_established()` method is invoked. This interception point allows the Interceptor to change the POA's object reference factory, which will be used to manufacture object references.

## Order of ORB events during object reference creation

The following events occur during calls to POA that create object reference, such as `create_reference()`, `create_reference_with_id()`.

- 1 Call the object reference factory's `make_object()` method to create the object reference (this does not call the VisiBroker IOR creation Interceptors, and the factory may be user-supplied). If there are no VisiBroker IOR creation Interceptors installed, this should be the object reference returned to the application; otherwise, proceed to step 2.
- 2 Extract the IOR from the delegate of the returned object reference, and call the VisiBroker IOR creation Interceptors' `create()` method.
- 3 IOR from step 2 is returned as the object reference to the caller of `create_reference()`, `create_reference_with_id()`.



# Using object wrappers

This section describes the object wrapper feature of VisiBroker, which allows your applications to be notified or to trap an operation request for an object.

## Object wrappers overview

The VisiBroker object wrapper feature allows you to define methods that are called when a client application invokes a method on a bound object or when a server application receives an operation request. Unlike the interceptor feature which is invoked at the VisiBroker ORB level, object wrappers are invoked before an operation request has been marshalled. In fact, you can design object wrappers to return results without the operation request having ever been marshalled, sent across the network, or actually presented to the object implementation. For more information about VisiBroker Interceptors, see [“Using VisiBroker Interceptors”](#).

Object wrappers may be installed on just the client-side, just the server-side, or they may be installed in both the client and server portions of a single application.

The following are a few examples of how you might use object wrappers in your application:

- Log information about the operation requests issued by a client or received by a server.
- Measure the time required for operation requests to complete.
- Cache the results of frequently issued operation requests so results can be immediately returned, without actually contacting the object implementation each time.

### Note

Externalizing a reference to an object for which object wrappers have been installed, using the VisiBroker ORB Object's `object_to_string` method, will not propagate those wrappers to the recipient of the stringified reference if the recipient is a different process.

## Typed and un-typed object wrappers

VisiBroker offers two kinds of object wrappers: *typed* and *untyped*. You can mix the use of both of these object wrappers within a single application. For information on typed wrappers, see [“Typed object wrappers”](#). For information on untyped wrappers, see [“Untyped object wrappers”](#). The following table summarizes the important distinctions between these two kinds of object wrappers.

Features	Typed	Untyped
Receives all arguments that are to be passed to the stub.	Yes	No
Can return control to the caller without actually invoking the next wrapper, the stub, or the object implementation.	Yes	No
Will be invoked for all operation requests for all objects.	No	Yes

## Special idl2java requirements

Whenever you plan to use typed or untyped object wrappers, you must ensure that you use the `-obj_wrapper` option with the `idl2java` compiler when you generate the code for your applications. This will result in the generation of:

- An object wrapper base class for each of your interfaces.
- Additional Helper class methods for adding or removing object wrappers.

## Object wrapper example applications

The sample client and server applications used to illustrate both the typed and untyped object wrapper concepts in this section are located in the following directory:

```
<install_dir>\examples\vbroker\interceptors\
objectWrappers\
```

## Untyped object wrappers

Untyped object wrappers allow you to define methods that are to be invoked before an operation request is processed, after an operation request is processed, or both. Untyped wrappers can be installed for client or server applications and you can also install multiple versions.

You may also mix the use of both typed and untyped object wrappers within the same client or server application.

By default, untyped object wrappers have a global scope and will be invoked for any operation request. You can design untyped wrappers so that they have no effect for operation requests on object types in which you are not interested.

### Note

Unlike typed object wrappers, untyped wrapper methods do not receive the arguments that the stub or object implementation would receive nor can they prevent the invocation of the stub or object implementation.

The following figure shows how an untyped object wrapper's `pre_method` is invoked before the client stub method and how the `post_method` is invoked afterward. It also shows the calling sequence on the server-side with respect to the object implementation.

**Figure 34** Single untyped object wrapper

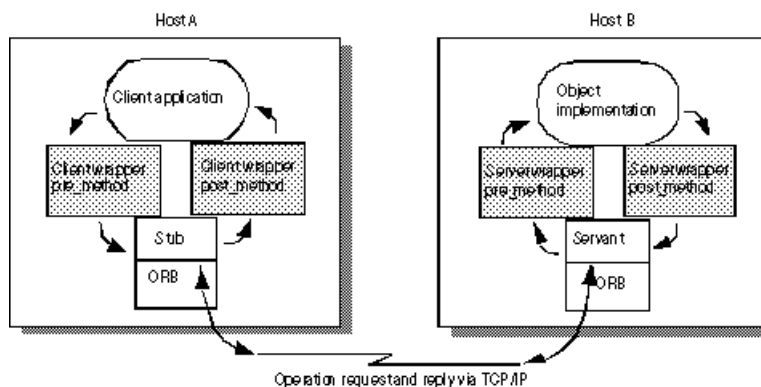

## Using multiple, untyped object wrappers

Figure 35 Multiple untyped object wrappers

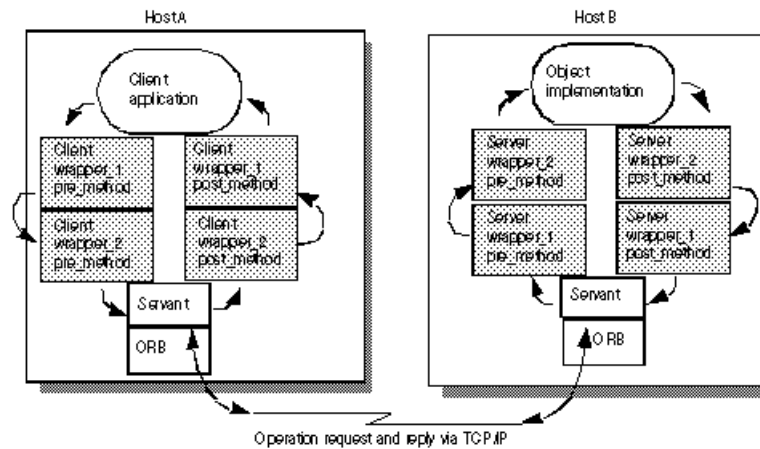

### Order of pre\_method invocation

When a client invokes a method on a bound object, each untyped object wrapper `pre_method` will receive control before the client's stub routine is invoked. When a server receives an operation request, each untyped object wrapper `pre_method` will be invoked before the object implementation receives control. In both cases, the first `pre_method` to receive control will be the one belonging to the object wrapper that was *registered first*.

### Order of post\_method invocation

When a server's object implementation completes its processing, each `post_method` will be invoked before the reply is sent to the client. When a client receives a reply to an operation request, each `post_method` will be invoked before control is returned to the client. In both cases, the first `post_method` to receive control will be the one belonging to the object wrapper that was *registered last*.

#### Note

If you choose to use both typed and untyped object wrappers, see [“Combined use of untyped and typed object wrappers”](#) for information on the invocation order.

## Using untyped object wrappers

The following are the required steps for using untyped object wrappers. Each step is discussed in further detail in the following sections.

- 1 Identify the interface, or interfaces, for which you want to create a untyped object wrapper.
- 2 Generate the code from your IDL specification using the `idl2java` compiler with the `-obj_wrapper` option.
- 3 Create an implementation for your untyped object wrapper factory, derived from the `UntypedObjectWrapperFactory` class.

- 4 Create an implementation for your untyped object wrapper, derived from the `UntypedObjectWrapper` class.
- 5 Modify your client or server application to access the appropriate type of `ChainUntypedObjectWrapperFactory`.
- 6 Modify your application to create your untyped object wrapper factory.
- 7 Use the `ChainUntypedObjectWrapperFactory` `add` method to add your factory to the chain.

## Implementing an untyped object wrapper factory

The implementation of the `TimingUntypedObjectWrapperFactory`, part of the `objectWrappers` sample applications, shows how to define an untyped object wrapper factory, derived from the `UntypedObjectWrapperFactory`.

Your factory's `create` method will be invoked to create an untyped object wrapper whenever a client binds to an object or a server invokes a method on an object implementation. The `create` method receives the target object, which allows you to design your factory to not create an untyped object wrapper for those object types you wish to ignore. It also receives an enum specifying whether the object wrapper created is for the server side object implementation or the client side object.

The following code sample illustrates an example of the `TimingObjectWrapperFactory`, which is used to create an untyped object wrapper that displays timing information for method calls.

```
package UtilityObjectWrappers;
import com.inprise.vbroker.interceptor.*;
public class TimingUntypedObjectWrapperFactory implements
    UntypedObjectWrapperFactory {
    public UntypedObjectWrapper create(org.omg.CORBA.Object
target,
    com.inprise.vbroker.interceptor.Location loc) {
    return new TimingUntypedObjectWrapper();
    }
}
```

## Implementing an untyped object wrapper

The following code sample shows the implementation of the `TimingObjectWrapper`. Your untyped wrapper must be derived from the `UntypedObjectWrapper` class, and you may provide an implementation for both the `pre_method` or `post_method` methods in your untyped object wrapper.

Once your factory has been installed, either automatically by the factory's constructor or manually by invoking the `ChainUntypedObjectWrapper::add` method, an untyped object wrapper object will be created automatically whenever your client binds to an object or when your server invokes a method on an object implementation.

The `pre_method` shown in the following code sample obtains the current time, saves it in a private variable, and prints a message. The `post_method` also obtains the current time, determines how much time that has elapsed since the `pre_method` was called, and prints the elapsed time.

```
package UtilityObjectWrappers;
import com.inprise.vbroker.interceptor.*;
Public class TimingUntypedObjectWrapper implements
UntypedObjectWrapper {
    private long time;
    public void pre_method(String operation,
        org.omg.CORBA.Object target,
        Closure closure) {
        System.out.println("Timing: " +
            ((com.inprise.vbroker.CORBA.Object)
target)._object_name() + "->"
            + operation + "()");
        time = System.currentTimeMillis();
    }
    public void post_method(String operation,
        org.omg.CORBA.Object target,
        org.omg.CORBA.Environment env,
        Closure closure) {
        long diff = System.currentTimeMillis() - time;
        System.out.println("Timing: Time for call \t" +
            ((com.inprise.vbroker.CORBA.Object)
target)._object_name() + "->" + operation +
            "() = " + diff + " ms.");
    }
}
```

### pre\_method and post\_method parameters

Both the `pre_method` and `post_method` receive the parameters shown in the following table.

Parameter	Description
operation	Name of the operation that was requested on the target object.
target	Target object.
closure	Area where data can be saved across method invocations for this wrapper.
environment	<code>post_method</code> only parameter used to inform the user of any exceptions that might have occurred during the previous steps of the method invocation.

## Creating and registering untyped object wrapper factories

The following code shows a portion of the sample file `UntypedClient.java`, which shows the creation and installation of two untyped object wrapper factories for a client. The factories are created after the VisiBroker ORB has been initialized, but before the client binds to any objects.

```
// UntypedClient.java
import com.inprise.vbroker.interceptor.*;
Public class UntypedClient {
    public static void main(String[] args) throws Exception
    {
        // Initialize the ORB.
        org.omg.CORBA.ORB orb =
org.omg.CORBA.ORB.init(args,null);
        doMain (orb, args);
    }
    public static void domain(org.omg.CORBA.ORB orb,
String[] args) throws
        Exception {
        ChainUntypedObjectWrapperFactory Cfactory =
            ChainUntypedObjectWrapperFactoryHelper.narrow(

orb.resolve_initial_references("ChainUntypedObjectWrapperF
actory")
        );
        Cfactory.add(new
UtilityObjectWrappers.TimingUntypedObjectWrapperFactory(),
            Location.CLIENT);
        Cfactory.add(new
UtilityObjectWrappers.TracingUntypedObjectWrapperFactory()
,
            Location.CLIENT);
        // Locate an account manager... .
    }
}
```

The following code sample illustrates the sample file `UntypedServer.java`, which shows the creation and registration of untyped object wrapper factories for a server. The factories are created after the VisiBroker ORB is initialized, but before any object implementations are created.

```
// UntypedServer.java
import com.inprise.vbroker.interceptor.*;
import org.omg.PortableServer.*;
Import
com.inprise.vbroker.PortableServerExt.BindSupportPolicyVal
ue;
import
com.inprise.vbroker.PortableServerExt.BindSupportPolicyVal
ueHelper;
import
com.inprise.vbroker.PortableServerExt.BIND_SUPPORT_POLICY_
TYPE;
public class UntypedServer {
    public static void main(String[] args) throws Exception
    {
```



```

        // Initialize the ORB.
        org.omg.CORBA.ORB orb =
org.omg.CORBA.ORB.init(args,null);
        ChainUntypedObjectWrapperFactory Sfactory =
            ChainUntypedObjectWrapperFactoryHelper.narrow
(orb.resolve_initial_references("ChainUntypedObjectWrapper
Factory"));
        Sfactory.add(new

UtilityObjectWrappers.TracingUntypedObjectWrapperFactory()
,
        Location.SERVER);
        // get a reference to the root POA
        POA rootPoa =

POAHelper.narrow(orb.resolve_initial_references("RootPOA")
);
        // Create a BindSupport Policy that makes POA
register each servant
        // with osagent
        org.omg.CORBA.Any any = orb.create_any();
        BindSupportPolicyValueHelper.insert(any,
            BindSupportPolicyValue.BY_INSTANCE);
        org.omg.CORBA.Policy bsPolicy =

orb.create_policy(BIND_SUPPORT_POLICY_TYPE.value, any);
        // Create policies for our testPOA
        org.omg.CORBA.Policy[] policies = {
            rootPoa.create_lifespan_policy
                (LifespanPolicyValue.PERSISTENT),
bsPolicy
        };
        // Create myPOA with the right policies
        POA myPOA = rootPoa.create_POA( "bank_agent_poa",
            rootPoa.the_POAManager(),
            policies );

        // Create the account manager object.
        AccountManagerImpl managerServant = new
AccountManagerImpl();
        // Decide on the ID for the servant
        byte[] managerId = "BankManager".getBytes();
        // Activate the servant with the ID on myPOA
        myPOA.activate_object_with_id(managerId,
managerServant);
        // Activate the POA manager
        rootPoa.the_POAManager().activate();
        System.out.println("AccountManager: BankManager is
ready.");
        for( int i = 0; i < args.length; i++ ) {
            if( args[i].equalsIgnoreCase("-runCoLocated") ) {
                if( args[i+1].equalsIgnoreCase("Client") ) {
                    Client.doMain(orb, new String[0]);
                } else if(
args[i+1].equalsIgnoreCase("TypedClient") ) {
                    TypedClient.doMain(orb, new String[0]);
                }
            }
            if(
args[i+1].equalsIgnoreCase("UntypedClient") ) {
                UntypedClient.doMain(orb, new String[0]);
            }
        }
    }
}

```

```

        }
        System.exit(1);
    }
}
// Wait for incoming requests
orb.run();
}
}

```

## Removing untyped object wrappers

The `ChainUntypedObjectWrapperFactory` class `remove` method can be used to remove an untyped object wrapper factory from a client or server application. You must specify a location when removing a factory. This means that if you have added a factory with a location of `Both`, you can selectively remove it from the `Client` location, the `Server` location, or `Both`.

### Note

Removing one or more object wrapper factories from a client will not affect objects of that class that are already bound by the client. Only subsequently bound objects will be affected. Removing object wrapper factories from a server will not affect object implementations that have already been created. Only subsequently created object implementations will be affected.

## Typed object wrappers

When you implement a typed object wrapper for a particular class, you define the processing that is to take place when a method is invoked on a bound object. The following figure shows how an object wrapper method on the client is invoked before the client stub class method and how an object wrapper on the server-side is invoked before the server's implementation method.

### Note

Your typed object wrapper implementation is not required to implement all methods offered by the object it is wrapping.

You may also mix the use of both typed and untyped object wrappers within the same client or server application. For more information, see [“Combined use of untyped and typed object wrappers”](#).

**Figure 36** Single typed object wrapper registered

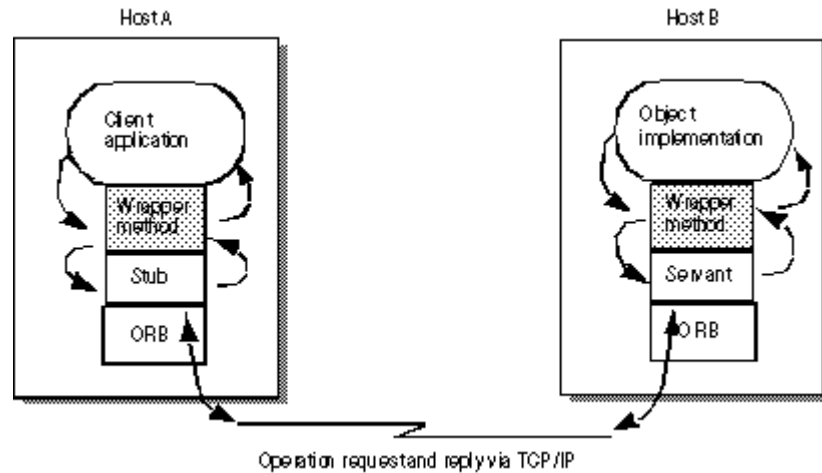

## Using multiple, typed object wrappers

You can implement and register more than one typed object wrapper for a particular class of object, as shown in the following figure.

On the client side, the first object wrapper registered is `client_wrapper_1`, so its methods will be the first to receive control. After performing its processing, the `client_wrapper_1` method may pass control to the next object's method in the chain or it may return control to the client.

On the server side, the first object wrapper registered is `server_wrapper_1`, so its methods will be the first to receive control. After performing its processing, the `server_wrapper_1` method may pass control to the next object's method in the chain or it may return control to the servant.

**Figure 37** Multiple, typed object wrappers registered

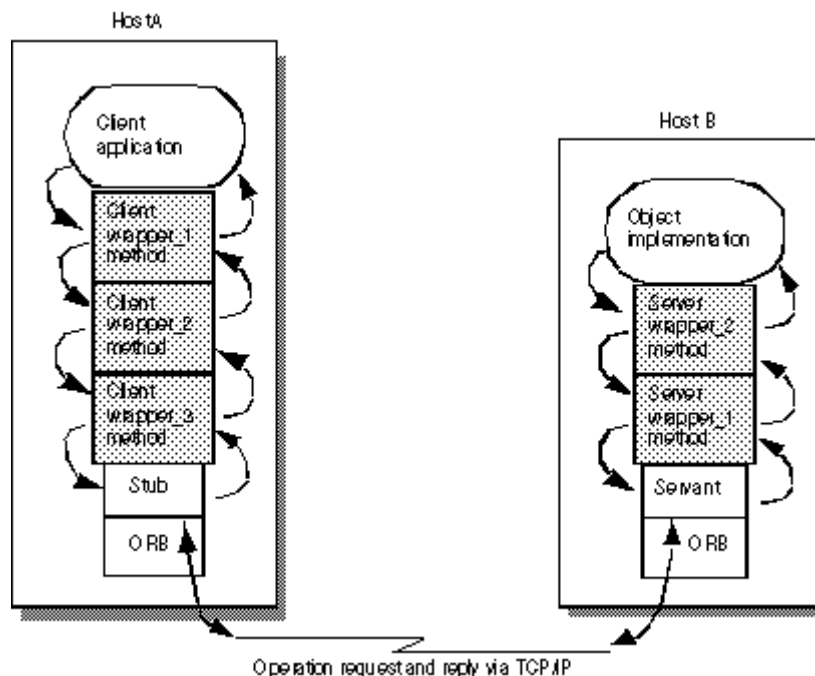

## Order of invocation

The methods for a typed object wrapper that are registered for a particular class will receive all of the arguments that are normally passed to the stub method on the client side or to the skeleton on the server side. Each object wrapper method can pass control to the next wrapper method in the chain by invoking the parent class' method, `super.<method_name>`. If an object wrapper wishes to return control without calling the next wrapper method in the chain, it can `return` with the appropriate return value.

A typed object wrapper method's ability to return control to the previous method in the chain allows you to create a wrapper method that never invokes a client stub or object implementation. For example, you can create an object wrapper method that caches the results of a frequently requested operation. In this scenario, the first invocation of a method on the bound object results in an operation request being sent to the object implementation. As control flows back through the object wrapper method, the result is stored. On subsequent invocations of the same method, the object wrapper method can simply return the cached result without actually issuing the operation request to the object implementation.

If you choose to use both typed and untyped object wrappers, see ["Combined use of untyped and typed object wrappers"](#) for information on the invocation order.

## Typed object wrappers with co-located client and servers

When the client and server are both packaged in the same process, the first object wrapper method to receive control will belong to the first client-side object wrapper that was installed. The following figure illustrates the invocation order.

**Figure 38** Typed object wrapper invocation order

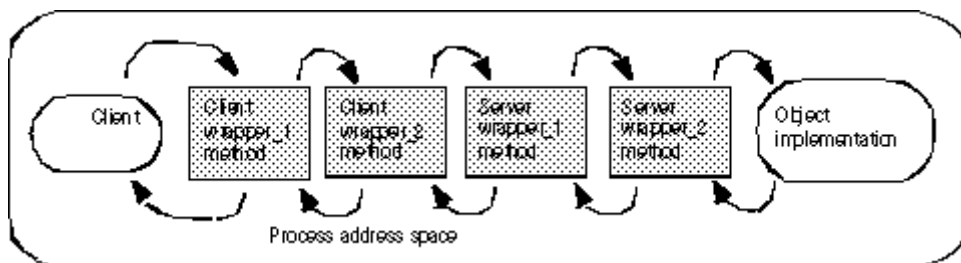

## Using typed object wrappers

The following are the required steps for using typed object wrappers. Each step is discussed in further detail in the following sections.

- 1 Identify the interface, or interfaces, for which you want to create a typed object wrapper.
- 2 Generate the code from your IDL specification using the `idl2java` compiler with the `-obj_wrapper` option.
- 3 Derive your typed object wrapper class from the `<interface_name>ObjectWrapper` class generated by the compiler, and provide an implementation of those methods you wish to wrap.

4 Modify your application to register the typed object wrapper.

## Implementing typed object wrappers

You derive typed object wrappers from the `<interface_name>ObjectWrapper` class that is generated by the `idl2java` compiler.

The following code sample shows the implementation of a typed object wrapper for the `Account` interface in Java.

Notice that this class is derived from the `AccountObjectWrapper` interface and provides a simple caching implementation of the `balance` method, which provides these processing steps:

- 1 Check the `_initialized` flag to see if this method has been invoked before.
- 2 If this is the first invocation, the `balance` method on the next object in the chain is invoked and the result is saved to `_balance`, the `_initialized` flag is set to `true`, and the value is returned.
- 3 If this method has been invoked before, simply return the cached value.

```
package BankWrappers;
public class CachingAccountObjectWrapper extends
Bank.AccountObjectWrapper {
    private boolean _initialized = false;
    private float _balance;
    public float balance() {
        System.out.println("+ CachingAccountObjectWrapper:
Before calling|
balance:
");
        try {
            if( !_initialized ) {
                _balance = super.balance();
                _initialized = true;
            } else {
                System.out.println("+
CachingAccountObjectWrapper: Returning Cached
value");
            }
            return _balance;
        } finally {
            System.out.println("+
CachingAccountObjectWrapper: After calling
balance: ");
        }
    }
}
```

## Registering typed object wrappers for a client

A typed object wrapper is registered on the client-side by invoking the `addClientObjectWrapperClass` method in Java that is generated for the class by the `idl2java` compiler. Client-side object wrappers must be registered after the `ORB.init` method has been called, but before any objects are bound. The following code sample shows a portion of the `TypedClient.java` file that creates and registers a typed object wrapper.

```

// TypedClient.java
import com.inprise.vbroker.interceptor.*;
Public class TypedClient {
    public static void main(String[] args) throws Exception
    {
        // Initialize the ORB.
        org.omg.CORBA.ORB orb =
org.omg.CORBA.ORB.init(args,null);
        domain (orb, args);
    }
    public static void domain(org.omg.CORBA.ORB orb,
String[] args) {
        // Add a typed object wrapper for Account objects
        Bank.AccountHelper.addClientObjectWrapperClass(orb,

BankWrappers.CachingAccountObjectWrapper.class);
        // Locate an account manager.
        Bank.AccountManager manager =
            Bank.AccountManagerHelper.bind(orb,
"BankManager");
        ...
    }
}

```

The VisiBroker ORB keeps track of any object wrappers that have been registered for it on the client side. When a client invokes the `_bind` method to bind to an object of that type, the necessary object wrappers will be created. If a client binds to more than one instance of a particular class of object, each instance will have its own set of wrappers.

## Registering typed object wrappers for a server

As with a client application, a typed object wrapper is registered on the server side by invoking the `addServerObjectWrapperClass` method offered by the Helper class. Server side, typed object wrappers must be registered after the `ORB.init` method has been called, but before an object implementation services a request. The following code sample shows a portion of the `TypedServer.java` file that installs a typed object wrapper.

```

// TypedServer.java
import org.omg.PortableServer.*;
import
com.inprise.vbroker.PortableServerExt.BindSupportPolicyVal
ue;
import
com.inprise.vbroker.PortableServerExt.BindSupportPolicyVal
ueHelper;
import
com.inprise.vbroker.PortableServerExt.BIND_SUPPORT_POLICY_
TYPE;
public class TypedServer {
    public static void main(String[] args) throws Exception
    {
        // Initialize the ORB.
        org.omg.CORBA.ORB orb =
org.omg.CORBA.ORB.init(args,null);
        // Add two typed object wrappers for AccountManager
objects

Bank.AccountManagerHelper.addServerObjectWrapperClass(orb,

```

```

BankWrappers.SecureAccountManagerObjectWrapper.class);
Bank.AccountManagerHelper.addServerObjectWrapperClass(orb,
BankWrappers.CachingAccountManagerObjectWrapper.class);
    // get a reference to the root POA
    POA rootPoa =

POAHelper.narrow(orb.resolve_initial_references("RootPOA")
);
    // Create a BindSupport Policy that makes POA
register each servant
    // with osagent
    org.omg.CORBA.Any any = orb.create_any();
    BindSupportPolicyValueHelper.insert(any,

BindSupportPolicyValue.BY_INSTANCE);
    org.omg.CORBA.Policy bsPolicy =

orb.create_policy(BIND_SUPPORT_POLICY_TYPE.value, any);
    // Create policies for our testPOA
    org.omg.CORBA.Policy[] policies = {

rootPoa.create_lifespan_policy(LifespanPolicyValue.PERSIST
ENT),
        bsPolicy
    };
    // Create myPOA with the right policies
    POA myPOA = rootPoa.create_POA( "lilo",
rootPoa.the_POAManager(),
    policies
);
    // Create the account manager object.
    AccountManagerImpl managerServant = new
AccountManagerImpl();
    // Decide on the ID for the servant
    byte[] managerId = "BankManager".getBytes();
    // Activate the servant with the ID on myPOA
    myPOA.activate_object_with_id(managerId,
managerServant);
    // Activate the POA manager
    rootPoa.the_POAManager().activate();
    System.out.println("AccountManager: BankManager is
ready.");

    For( int i = 0; i < args.length; i++ ) {
        if ( args[i].equalsIgnoreCase("-runCoLocated") )
    {
        if( args[i+1].equalsIgnoreCase("Client") ) {
            Client.doMain(orb, new String[0]);
        } else if(
args[i+1].equalsIgnoreCase("TypedClient") ) {
            TypedClient.doMain(orb, new String[0]);
        }
        if(
args[i+1].equalsIgnoreCase("UntypedClient") ) {
            UntypedClient.doMain(orb, new String[0]);
        }
    }
    System.exit(1);

```

```

        }
    }
    // Wait for incoming requests
    orb.run();
}
}

```

If a server creates more than one instance of a particular class of object, a set of wrappers will be created for each instance.

## Removing typed object wrappers

The `Helper` class also provides methods for removing a typed object wrapper from a client or server application.

### Note

Removing one or more object wrappers from a client will not affect objects of that class that are already bound by the client. Only subsequently bound objects will be affected. Removing object wrappers from a server will not affect object implementations that have already serviced requests. Only subsequently created object implementations will be affected.

## Combined use of untyped and typed object wrappers

If you choose to use both typed and untyped object wrappers in your application, all `pre_method` methods defined for the untyped wrappers will be invoked prior to any typed object wrapper methods defined for an object. Upon return, all typed object wrapper methods defined for the object will be invoked prior to any `post_method` methods defined for the untyped wrappers.

The sample applications `Client.java` and `Server.java` make use of a sophisticated design that allows you to use command-line properties to specify which, if any, typed and untyped object wrappers are to be used.

## Command-line arguments for typed wrappers

The typed wrappers may be enabled by specifying the following on the command-line:

- 1 `-Dvbroker.orb.dynamicLibs=BankWrappers.Init`
- 2 Using one or more of the properties described in the following table.

BankWrappers properties	Description
<code>-DCachingAccount</code> <code>[=&lt;client server&gt;]</code>	Installs a typed object wrapper that caches the results of the <code>balance</code> method for a client or a server. If no value for sub-property is specified, both the client and server wrappers are installed.



BankWrappers properties	Description
-DCachingAccountManager [=<client server>]	Installs a typed object wrapper that caches the results of the <code>open</code> method for a client or a server. If no value for the sub-property is specified, both the client and server wrappers are installed.
-DSecureAccountManager [=<client server>]	Installs a typed object wrapper that detects unauthorized users passed on the <code>open</code> method for a client or a server. If no value for sub-property is specified, both the client and server wrappers are installed.

## Initializer for typed wrappers

The typed wrappers are defined in the `BankWrappers` package and include a service initializer, `BankWrappers/Init.java`, as shown in the following code. This initializer will be invoked if you specify -

`Dvbroker.orb.dynamicLibs=BankWrappers.Init` on the command-line when starting the client or server with `vbj`. Various typed object wrappers can be installed, based on the command-line properties you supply.

```

package BankWrappers;
import java.util.*;
import com.inprise.vbroker.orb.ORB;
import com.inprise.vbroker.properties.PropertyManager;
import com.inprise.vbroker.interceptor.*;
public class Init implements ServiceLoader {
    com.inprise.vbroker.orb.ORB _orb;
    public void init(final org.omg.CORBA.ORB orb) {
        _orb = (ORB) orb;
        PropertyManager pm = _orb.getPropertyManager();
        // install my CachingAccountObjectWrapper
        String val = pm.getString("CachingAccount",
this.toString());
        Class c = CachingAccountObjectWrapper.class;
        if( !val.equals(this.toString())) {

            if( val.equalsIgnoreCase("client") ) {

Bank.AccountHelper.addClientObjectWrapperClass(orb, c);
            } else if( val.equalsIgnoreCase("server") ) {

Bank.AccountHelper.addServerObjectWrapperClass(orb, c);
            } else {

Bank.AccountHelper.addClientObjectWrapperClass(orb, c);
Bank.AccountHelper.addServerObjectWrapperClass(orb, c);
            }
        }
        // install my CachingAccountManagerObjectWrapper
        val = pm.getString("CachingAccountManager",
this.toString());
        c = CachingAccountManagerObjectWrapper.class;
        if( !val.equals(this.toString())) {
            if( val.equalsIgnoreCase("client") ){

Bank.AccountManagerHelper.addClientObjectWrapperClass(orb,
c);
            } else if( val.equalsIgnoreCase("server") ) {

Bank.AccountManagerHelper.addServerObjectWrapperClass(orb,
c);

```

```

    } else {

Bank.AccountManagerHelper.addClientObjectWrapperClass(orb,
c);

Bank.AccountManagerHelper.addServerObjectWrapperClass(orb,
c);
    }
    }
    // install my CachingAccountManagerObjectWrapper
    val = pm.getString("SecureAccountManager",
        this.toString());
    c = SecureAccountManagerObjectWrapper.class;
    if( !val.equals(this.toString())) {
        if( val.equalsIgnoreCase("client") ){

Bank.AccountManagerHelper.addClientObjectWrapperClass(orb,
c);
        } else if( val.equalsIgnoreCase("server") ) {

Bank.AccountManagerHelper.addServerObjectWrapperClass(orb,
c);
        } else {

Bank.AccountManagerHelper.addClientObjectWrapperClass(orb,
c);

Bank.AccountManagerHelper.addServerObjectWrapperClass(orb,
c);
        }
    }
    }
    public void init_complete(org.omg.CORBA.ORB orb) {}
    public void shutdown(org.omg.CORBA.ORB orb) {}
}

```

## Command-line arguments for untyped wrappers

The untyped wrappers may be enabled by specifying the following on the command-line:

- 1 -Dvbroker.orb.dynamicLibs=UtilityObjectWrappers.Init
- 2 Using one or more of the properties summarized in the following table.

UtilityObjectWrappers properties	Description
-DTiming[=<client server>]	Installs an untyped object wrapper that timing information for a client or a server. If no value for the sub-property is specified, both the client and server wrappers are installed.
-DTracing[=<client server>]	Installs an untyped object wrapper that tracing information for a client or a server. If no value for the sub-property is specified, both the client and server wrappers are installed.

## Initializers for untyped wrappers

The untyped wrappers are defined in the UtilityObjectWrappers package and include a service initializer, UtilityObjectWrappers/Init.java, shown below. This initializer will be invoked if you specify -Dvbroker.orb.dynamicLibs=UtilityObjectWrappers.Init on the

command-line when starting the client or server with `vbj`. The Command-line properties for enabling or disabling `UtilityObjectWrappers` table summarizes the command-line arguments that you can use to install the various untyped object wrappers.

```

package UtilityObjectWrappers;
import java.util.*;
import com.inprise.vbroker.orb.ORB;
import com.inprise.vbroker.properties.PropertyManager;
import com.inprise.vbroker.interceptor.*;
Public class Init implements ServiceLoader {
    com.inprise.vbroker.orb.ORB _orb;
    public void init(final org.omg.CORBA.ORB orb) {
        _orb = (ORB) orb;
        PropertyManager PM= _orb.getPropertyManager();
        try {
            ChainUntypedObjectWrapperFactory factory =
ChainUntypedObjectWrapperFactoryHelper.narrow(
orb.resolve_initial_references("ChainUntypedObjectWrapperF
actory"));
            // install my Timing ObjectWrapper
            String val = pm.getString("Timing", this.toString());
            if( !val.equals(this.toString()) ) {
                UntypedObjectWrapperFactory f= new
TimingUntypedObjectWrapperFactory();
                if( val.equalsIgnoreCase("client") ){
                    factory.add(f, Location.CLIENT);
                } else if( val.equalsIgnoreCase("server") ) {
                    factory.add(f, Location.SERVER);
                } else {
                    factory.add(f, Location.BOTH);
                }
            }

            // install my Tracing ObjectWrapper
            val = pm.getString("Tracing", this.toString());
            if( !val.equals(this.toString()) ) {
                UntypedObjectWrapperFactory f= new
TracingUntypedObjectWrapperFactory();
                if( val.equalsIgnoreCase("client") ){
                    factory.add(f, Location.CLIENT);
                } else if( val.equalsIgnoreCase("server") ) {
                    factory.add(f, Location.SERVER);
                } else {
                    factory.add(f, Location.BOTH);
                }
            }
        } catch( org.omg.CORBA.ORBPackage.InvalidName e ) {
            return;
        }
    }
    public void init_complete(org.omg.CORBA.ORB orb) {}
    public void shutdown(org.omg.CORBA.ORB orb) {}
}

```

## Executing the sample applications

Before executing the sample applications, make sure that an `osagent` is running on your network. For more information, see [“Starting a Smart Agent \(osagent\)”](#). You can then execute the server application without any tracing or timing object wrappers by using the following command:

```
prompt> vbj Server
```

### Note

The server is designed as a co-located application. It implements both the server and a client.

From another window, you can execute the client application without any tracing or timing object wrappers to query the balance in a user's account using the following command:

```
prompt> vbj Client John
```

You can also execute the following command if you want a default name to be used:

```
prompt> vbj Client
```

### Turning on timing and tracing object wrappers

To execute the client with untyped timing and tracing object wrappers enabled, use the following command:

```
prompt> vbj -  
Dvbroker.orb.dynamicLibs=UtilityObjectWrappers.Init  
-DTiming=client\  
-DTracing=client Client John
```

To execute the server with untyped wrappers for timing and tracing enabled, use the following command:

```
prompt> vbj -  
Dvbroker.orb.dynamicLibs=UtilityObjectWrappers.Init  
-DTiming=server\  
-DTracing=server Server
```

### Turning on caching and security object wrappers

To execute the client with typed wrappers for caching and security enabled, use this command:

```
prompt> vbj -Dvbroker.orb.dynamicLibs=BankWrappers.Init -  
DCachingAccount=client\  
-DCachingAccountManager=client\  
-DSecureAccountManager=client  
Client John
```

To execute the server with typed wrappers for caching and security enabled, use the following command:

```
prompt> vbj -Dvbroker.orb.dynamicLibs=BankWrappers.Init  
-DCachingAccount=server \  
-DCachingAccountManager=server \  
-DSecureAccountManager=server \  
Server
```

### Turning on typed and untyped wrappers

To execute the client with all typed and untyped wrappers enabled, use the following command:

```
prompt> vbj -DOvbroker.orb.dynamicLibs=BankWrappers.Init,  
UtilityObjectWrappers.Init \  
-DCachingAccount=client \  
-DCachingAccountManager=client\  
-DSecureAccountManager=client \  
Client John
```

```
-DTiming=client \  
-DTracing=client \  
Client John
```

To execute the server with all typed and untyped wrappers enabled, use the following command:

```
prompt> vbj -Dvbroker.orb.dynamicLibs=BankWrappers.Init,  
            UtilityObjectWrappers.Init \  
            -DCachingAccount=server \  
            -DCachingAccountManager=server\  
            -DSecureAccountManager=server \  
            -DTiming=server \  
            -DTracing=server \  
Server
```

### Executing a Co-located client and server

The following command will execute a Co-located server and client with all typed wrappers enabled, the untyped wrapper enabled for just the client, and the untyped tracing wrapper for just the server:

```
prompt> vbj -Dvbroker.orb.dynamicLibs=BankWrappers.Init,  
            UtilityObjectWrappers.Init \  
            -DCachingAccount -DSecureAccountManager \  
            -DTiming=client -DTracing=server \  
Server -runCoLocated Client
```

Specifying the `-runCoLocated` command-line option allows you to execute the client and server within the same process.

Property	Description
<code>-runCoLocated Client</code>	Executes the <code>Server.java</code> and the <code>Client.java</code> within the same process.
<code>-runCoLocated TypedClient</code>	Executes the <code>Server.java</code> and the <code>TypedClient.java</code> within the same process.
<code>-runCoLocated UntypedClient</code>	Executes the <code>Server.java</code> and the <code>UntypedClient.java</code> within the same process.



# Event Queue

This section provides information about the Event Queue feature. This feature is provided for the server-side only.

A server can register listeners to the event queue based on event types that the server is interested in and therefore can process those events when the server needs to do so.

## Event types

Currently, connection event type is the only event type generated.

### Connection events

There are two connection events that the VisiBroker ORB will generate and push to the registered connection event, as follows:

- *Connection established*: indicates that a new client is connected to the server successfully.
- *Connection closed*: indicates that an existing client is disconnected from the server.

## Event listeners

A server implements and registers listeners with the VisiBroker ORB based on event types the server needs to process. The connection event listener is the only event listener supported.

### IDL definition

The interface definitions are as follows:

```
module EventQueue {
    // Connection event types
    enum EventType {UNDEFINED, CONN_EVENT_TYPE};
    // Peer (Client) connection info
    struct ConnInfo {
        string ipaddress; // in %d.%d.%d.%d format
        long port;
        long connID;
    };
    // Marker interface for all types of event listeners
    local interface EventListener {};
    typedef sequence<EventListener> EventListeners;
    // connection event listener interface
    local interface ConnEventListener : EventListener{
        void conn_established(in ConnInfo info);
        void conn_closed(in ConnInfo info);
    };
    // The EventQueue manager
    local interface EventQueueManager :
    interceptor::InterceptorManager {
        void register_listener(in EventListener listener, in
        EventType type);
    };
};
```

```

        void unregister_listener(in EventListener listener,
in EventType type);
        EventListeners get_listeners(in EventType type);
    };
};

```

The details of the interface definitions are described in the following sections.

### ConnInfo structure

The ConnInfo structure contains the following client connection information.

Parameter	Description
ipaddress	stores the client ip address
port	stores the client port number
connID	stores the per server unique identification for this client connection

### EventListener interface

The EventListener interface section is the marker interface for all types of event listeners.

### ConnEventListeners interface

The ConnEventListeners interface defines the following operations.

Operation	Description
void conn_established (in ConnInfo info)	This operation is called back by the VisiBroker ORB to push the connection established event. The VisiBroker ORB fills in the client connection information into the in ConnInfo info parameter and passes this value into the callback operation.
void conn_closed (in ConnInfo info)	This operation is called back by the VisiBroker ORB to push the connection closed event. The VisiBroker ORB fills in the client connection information into the in ConnInfo info parameter and passes this value into the callback operation.

The server-side application is responsible for the implementation of the ConnEventListener interface as well as the processing of the events being pushed into the listener.

### EventQueueManager interface

The EventQueueManager interface is used as a handle by the server-side implementation for the registration of event listeners. This interface defines the the following operations.

Operation	Description
void register_listener (in EventListener listener, in EventType type)	This operation is provided for the registration of an event listener with the specified event type.
EventListeners get_listeners (in EventType type)	This operation returns the list of registered event listeners for the specified type.
void unregister_listener (in EventListener listener, in EventType type)	This operation removes a pre-registered listener of the specified type.



## How to return the EventQueueManager

An `EventQueueManager` object is created upon ORB initialization. Server-side implementation returns the `EventQueueManager` object reference using the following code:

```
com.inprise.vbroker.interceptor.InterceptorManagerControl
control =

com.inprise.vbroker.interceptor.InterceptorManagerControlH
elper.narrow(

orb.resolve_initial_references("VisiBrokerInterceptorContr
ol"));
EventQueueManager manager =
    (EventQueueManager)control.get_manager("EventQueue");
EventListener theListener = ...
manager.register_listeners(theListener);
```

## Event Queue code samples

This section contains some code samples for registering `EventListeners` and implementing a connection `EventListener`.

### Registering EventListeners

The `SampleServerLoader` class contains the `init()` method which is called by the ORB during initialization. The purpose of the `ServerLoader` is to register an `EventListener` by creating and registering it to the `EventQueueManager`.

```
import com.inprise.vbroker.EventQueue.*;
import com.inprise.vbroker.interceptor.*;
import com.inprise.vbroker.PortableServerExt.*;
public class SampleServerLoader implements ServiceLoader {
    public void init(org.omg.CORBA.ORB orb) {
        try {
            InterceptorManagerControl control =
                InterceptorManagerControlHelper.narrow(

orb.resolve_initial_references("VisiBrokerInterceptorContr
ol"));
            EventQueueManager queue_manager =
                (EventQueueManager)
control.get_manager("EventQueue");
            queue_manager.register_listener((EventListener)new
ConnEventListenerImpl(), EventType.CONN_EVENT_TYPE);
        }
        catch(Exception e) {
            e.printStackTrace();
            throw new org.omg.CORBA.INITIALIZE(e.toString());
        }
        System.out.println("=====>SampleServerLoader:
ConnEventListener
            registered");
    }
    public void init_complete(org.omg.CORBA.ORB orb) {
    }
    public void shutdown(org.omg.CORBA.ORB orb) {
    }
}
```

## Implementing EventListeners

The `ConnEventListenerImpl` contains a connection event listener implementation sample. The `ConnEventListener` interface implements the `conn_established` and `conn_closed` operations at the server-side application. For more information, see [“ConnEventListeners interface”](#). The implementation enables the connection to idle for 30000 milliseconds while waiting for a request at the server-side. These operations are called when the connection is established by the client and when the connection is dropped, respectively.

```
import com.inprise.vbroker.EventQueue.*;
import org.omg.CORBA.LocalObject;

public class ConnEventListenerImpl extends LocalObject
implements ConnEventListener {
    public void conn_established(ConnInfo info) {
        System.out.println("Received conn_established: address
= " +
                            info.ipaddress + " port = " +
info.port +
                            " connID = " + info.connID);
        System.out.println("Processing the event ...");
        try {
            Thread.sleep(30000);
        } catch (Exception e) { e.printStackTrace(); }
    }
    public void conn_closed(ConnInfo info) {
        System.out.println("Received conn_closed: address = "
+
                            info.ipaddress+ " port = " +
info.port +
                            " connID = " + info.connID);
    }
}
```

# Using RMI over IIOP

This section describes the VisiBroker for Java tools which enable you to use RMI over IIOP, and also describes the setup permissions required when running Java applets that use RMI-IIOP.

## Overview of RMI over IIOP

RMI (remote method invocation) is a Java mechanism which allows objects to be created and used in a distributed environment. In this sense, RMI is a VisiBroker ORB, which is language-specific (Java) and non-CORBA compliant. The OMG has issued a specification, the Java language to IDL Mapping, which allows Java classes written using RMI to interoperate with CORBA objects using the IIOP encoding.

## Setting up Java applets with RMI-IIOP

You can run an applet that uses RMI-IIOP. However, you need to set the permissions in `Reflect` and `Runtime`. These permissions are set in the `java.policy` file located in the JRE installed directory. The following is an example of how to set the permissions in the `java.policy` file:

```
grant codeBase "http://xxx.xxx.xxx.xxx:8088/-" {
  permission java.lang.reflect.ReflectPermission
    "suppressAccessChecks";

  permission java.lang.RuntimePermission
    "accessDeclaredMembers";
};
```

## java2iiop and java2idl tools

VisiBroker has two compilers which allow you to adapt your existing Java classes to work with other objects using the VisiBroker ORB.

- The `java2iiop` compiler lets you adapt your RMI-compliant classes to use IIOP by generating all the proper skeleton, stub, and helper classes.
- The `java2idl` compiler generates IDL from your Java classes, allowing you to implement them in languages other than Java.

## Using java2iiop

The `java2iiop` compiler lets you define interfaces and data types in Java, rather than IDL, that can then be used as interfaces and data types in CORBA. The compiler does not read Java source code (`java` files) or IDL, but rather Java bytecode (`class` files). The compiler then generates IIOP-compliant stubs and skeletons needed to do all the marshalling and communication required for CORBA.

## Supported interfaces

When you run the `java2iiop` compiler, it generates the same files as if you had written the interface in IDL. All primitive data types like the numeric types (`short`, `int`, `long`, `float`, and `double`), `string`, CORBA objects or

interface objects, Any objects, typecode objects are understood by the java2iiop compiler and mapped to the corresponding IDL types.

You can use java2iiop on any Java class or interface. For example, if a Java interface adheres to one of the following rules:

- Extends `java.rmi.Remote` and all of its methods throw `java.rmi.RemoteException`
- Extends `org.omg.CORBA.Object`

then, java2iiop will translate the interface to a CORBA interface in IDL.

The following code sample illustrates a Java RMI interface. This code example can be found in:

```
<install_dir>/examples/vbroker/rmi-iiop/
public interface Account extends java.rmi.Remote {
    String name() throws java.rmi.RemoteException;
    float getBalance() throws java.rmi.RemoteException;
    void setBalance(float bal) throws
java.rmi.RemoteException;
}
```

## Running java2iiop

You must compile your Java classes before you can use the java2iiop compiler. Once you have generated bytecode, you can run java2iiop to generate client stubs, server skeletons, and the associated auxiliary files.

For example, after running java2iiop on the `Account.class` file found in

```
<install_dir>/examples/vbroker/rmi-iiop/Bank/
```

you would have the following files:

- `_Account_Stub`
- `AccountHelper`
- `AccountHolder`
- `AccountPOA`
- `Account_Tie`
- `AccountOperations`

## Reverse mapping of Java classes to IDL

When mapping IDL interfaces to Java classes, using the `idl2java` compiler, the interface name may use any of the generated classes suffixes (for example, `Helper`, `Holder`, `POA`, and so on), and the `idl2java` tool will handle the situation correctly by mangling the interface name (prefixing an underscore “`_`” to the identifier).

For example, if you define both a `Foo` and a `FooHolder` interface in IDL, `idl2java` will generate, amongst others, `Foo.java`, `FooHolder.java`, `_FooHolder.java`, and `_FooHolderHolder.java` files.

On the other hand, when generating IIOP-compliant Java classes from RMI Java classes, using the java2iiop compiler, the tool cannot generate the mangled classes.

So, when declaring interfaces which use reserved suffixes, you cannot have them in the same package as the interface with the same name, (for example, you can not have a `Foo` and a `FooHolder` class in the same package when using the java2iiop compiler).

## Completing the development process

After generating the associated files from your interfaces, you need to provide implementations for the interfaces. Follow these steps:

- 1 Create an implementation for the interface classes.
- 2 Compile your server class.
- 3 Write and compile your client code.
- 4 Start the Server program.
- 5 Run the Client program.

### Note

If you attempt to marshal a non-conforming class, an `org.omg.CORBA.MARSHAL: Cannot marshal non-conforming value of class <class name>` will be thrown. For instance, if you create the following two classes,

```
// This is a conforming class
public class Value implements java.io.Serializable {
    java.lang.Object any;
    ...
}
// This is a non-conforming class
public class Something {
    ...
}
```

and then attempt the following,

```
Value val = new Value();
val.any = new Something();
```

You will raise an `org.omg.CORBA.MARSHAL` exception when you attempt to marshal `val`.

## RMI-IIOP Bank example

This code example is located in the following directory:

```
<install_dir>/examples/vbroker/rmi-iiop/
```

The `Account` interface extends the `java.rmi.Remote` interface and is implemented by the `AccountImpl` class.

The `Client` class (below) first creates all the specified `Account` objects with the appropriate balances by creating `AccountData` objects for each account and passing them to the `AccountManager` to create the accounts. It then confirms that the balance is correct on the created account. The client then queries the `AccountManager` for a list of all the accounts, and proceeds to credit \$10.00 to each account. It then verifies if the new balance on the account is accurate.

```
public class AccountImpl extends Bank.AccountPOA {
    public AccountImpl(Bank.AccountData data) {
        _name = data.getName();
        _balance = data.getBalance();
    }
    public String name() throws java.rmi.RemoteException {
        return _name;
    }
}
```

```

public float getBalance() throws java.rmi.RemoteException {
    return _balance;
}
public void setBalance(float balance) throws java.rmi.RemoteException {
    _balance = balance;
}
private float _balance;
private String _name;
}

```

The Client class:

```

public class Client {
    public static void main(String[] args) {
        try {
            // Initialize the ORB.
            org.omg.CORBA.ORB orb = org.omg.CORBA.ORB.init(args,null);
            // Get the manager Id
            byte[] managerId = "RMIBankManager".getBytes();
            // Locate an account manager. Give the full POA name and the
            // servant ID.
            Bank.AccountManager manager = Bank.AccountManagerHelper.bind(orb,
"/rmi_bank_poa", managerId);
            // Use any number of argument pairs to indicate name,balance of
            // accounts to create
            if (args.length == 0 || args.length % 2 != 0) {
                args = new String[2];
                args[0] = "Jack B. Quick";
                args[1] = "123.23";
            }
            int i = 0;
            while (i < args.length) {
                String name = args[i++];
                float balance;
                try {
                    balance = new Float(args[i++]).floatValue();
                } catch (NumberFormatException n) {
                    balance = 0;
                }

                Bank.AccountData data = new Bank.AccountData(name,
                balance);
                Bank.Account account = manager.create(data);
                System.out.println("Created account for " +
                name
                + " with opening balance of $" +
                balance);
            }
            java.util.Hashtable accounts =
            manager.getAccounts();
            for (java.util.Enumeration e =
            accounts.elements();
            e.hasMoreElements();) {
                Bank.Account account =
                Bank.AccountHelper.narrow((org.omg.CORBA.Obj
            ect)e.nextElement());
                String name = account.name();
                float balance = account.getBalance();
                System.out.println("Current balance in " +
                name + "'s account is
                $" + balance);
            }
        }
    }
}

```

```

        System.out.println("Crediting $10 to " + name
+ "'s account.");
        account.setBalance(balance + (float)10.0);
        balance = account.getBalance();
        System.out.println("New balance in " + name +
"'s account is
        $" + balance);
    }
} catch (java.rmi.RemoteException e) {
    System.err.println(e);
}
}
}

```

## Supported data types

In addition to all of the Java primitive data types, RMI-IIOP supports a subset of Java classes.

### Mapping primitive data types

Client stubs generated by `java2iiop` handle the marshalling of the Java primitive data types that represent an operation request so that they may be transmitted to the object server. When a Java primitive data type is marshalled, it must be converted into an IIOP-compatible format. The following table summarizes the mapping of Java primitive data types to IDL/IIOP types.

Java type	IDL/IIOP type
<code>void</code>	<code>void</code>
<code>boolean</code>	<code>boolean</code>
<code>byte</code>	<code>octet</code>
<code>char</code>	<code>char</code>
<code>short</code>	<code>short</code>
<code>int</code>	<code>long</code>
<code>long</code>	<code>long long</code>
<code>float</code>	<code>float</code>
<code>double</code>	<code>double</code>
<code>java.lang.String</code>	<code>CORBA::WStringValue</code>
<code>java.lang.Object</code>	<code>any</code>
<code>java.io.Serializable</code>	<code>any</code>
<code>java.io.Externalizable</code>	<code>any</code>

### Mapping complex data types

This section shows how the `java2iiop` compiler can be used to handle complex data types.

#### Interfaces

Java interfaces are represented in IDL as CORBA interfaces, and they must inherit from the `org.omg.CORBA.Object` interface. When passing objects that implement these interfaces, they are passed by reference.

## **Arrays**

Another complex data type that may be defined in classes is an array. If you have an interface or definitions that use arrays, the arrays map to CORBA boxed sequence of boxed type.



# Using the dynamically managed types

This section describes the `DynAny` feature of VisiBroker, which allows you to construct and interpret data types at runtime.

## DynAny interface overview

The `DynAny` interface provides a way to dynamically create basic and constructed data types at runtime. It also allows information to be interpreted and extracted from an `Any` object, even if the type it contains was not known to the server at compile-time. Using the `DynAny` interface, you can build powerful client and server applications that create and interpret data types at run time.

## DynAny examples

Example client and server applications that illustrate the use of `DynAny` are included as part of the VisiBroker distribution. The examples are located in the following directory:

```
<install_dir>\examples\vbroker\dynany\
```

These example programs are used to illustrate `DynAny` concepts throughout this section.

## DynAny types

A `DynAny` object has an associated value that may either be a basic data type (such as `boolean`, `int`, or `float`) or a constructed data type. The `DynAny` interface, its methods and classes are also documented in the VisiBroker API References. “[Programmer tools for Java](#)” provides methods for determining the type of the contained data as well as for setting and extracting the value of primitive data types.

Constructed data types are represented by the following interfaces, which are all derived from `DynAny`. Each of these interfaces provides its own set of methods that are appropriate for setting and extracting the values it contains.

Interface	TypeCode	Description
<code>DynArray</code>	<code>_tk_array</code>	An array of values with the same data type that has a fixed number of elements.
<code>DynEnum</code>	<code>_tk_enum</code>	A single enumeration value.
<code>DynFixed</code>	<code>_tk_fixed</code>	Not supported.
<code>DynSequence</code>	<code>_tk_sequence</code>	A sequence of values with the same data type. The number of elements may be increased or decreased.
<code>DynStruct</code>	<code>_tk_struct</code>	A structure.
<code>DynUnion</code>	<code>_tk_union</code>	A union.
<code>DynValue</code>	<code>_tk_value</code>	Not supported.

## DynAny usage restrictions

A `DynAny` object may only be used locally by the process which created it. Any attempt to use a `DynAny` object as a parameter on an operation request for a bound object or to externalize it using the `ORB.object_to_string` method will cause a `MARSHAL` exception to be raised.

Furthermore, any attempt to use a `DynAny` object as a parameter on DII request will cause a `NO_IMPLEMENT` exception to be raised.

This version does not support the long double and fixed types as specified in CORBA 3.0.

## Creating a DynAny

A `DynAny` object is created by invoking an operation on a `DynAnyFactory` object. First obtain a reference to the `DynAnyFactory` object, and then use that object to create the new `DynAny` object.

```
// Resolve Dynamic Any Factory
DynAnyFactory factory =
    DynAnyFactoryHelper.narrow(
        orb.resolve_initial_references("DynAnyFactory"));
byte[] oid = "PrinterManager".getBytes();
// Create the printer manager object.
PrinterManagerImpl manager =
    new PrinterManagerImpl((com.inprise.vbroker.CORBA.ORB)
orb,
    factory, serverPoa, oid);
// Export the newly create object.
serverPoa.activate_object_with_id(oid, manager);
System.out.println(manager + " is ready.");
```

## Initializing and accessing the value in a DynAny

The `DynAny.insert_<type>` methods allow you to initialize a `DynAny` object with a variety of basic data types, where `<type>` is `boolean`, `octet`, `char`, and so on. Any attempt to insert a type that does not match the `TypeCode` defined for the `DynAny` will cause a `TypeMismatch` exception to be raised.

The `DynAny.get_<type>` methods allow you to access the value contained in a `DynAny` object, where `<type>` is `boolean`, `octet`, `char`, and so on. Any attempt to access a value from a `DynAny` component which does not match the `TypeCode` defined for the `DynAny` will cause a `TypeMismatch` exception to be raised.

The `DynAny` interface also provides methods for copying, assigning, and converting to or from an `Any` object. The sample programs, described in [“DynAny example client application”](#) and [“DynAny example server application”](#), provide examples of how to use some of these methods.

## Constructed data types

The following types are derived from the `DynAny` interface and are used to represent constructed data types.

## Traversing the components in a constructed data type

Several of the interfaces that are derived from `DynAny` actually contain multiple components. The `DynAny` interface provides methods that allow you to iterate through these components. The `DynAny`-derived objects that contain multiple components maintain a pointer to the current component.

<b>DynAny method</b>	<b>Description</b>
<code>rewind</code>	Resets the current component pointer to the first component. Has no effect if the object contains only one component.
<code>next</code>	Advances the pointer to the next component. If there are no more components or if the object contains only one component, <code>false</code> is returned.
<code>current_component</code>	Returns a <code>DynAny</code> object, which may be narrowed to the appropriate type, based on the component's <code>TypeCode</code> .
<code>seek</code>	Sets the current component pointer to the component with the specified, zero-based index. Returns <code>false</code> if there is no component at the specified index. Sets the current component pointer to <code>-1</code> (no component) if specified with a negative index.

## DynEnum

The `DynEnum` interface represents a single enumeration constant. Methods are provided for setting and obtaining the value as a string or as an integral value.

## DynStruct

The `DynStruct` interface represents a dynamically constructed `struct` type. The members of the structure can be retrieved or set using a sequence of `NameValuePair` objects. Each `NameValuePair` object contains the member's name and an `Any` containing the member's `Type` and value.

You may use the `rewind`, `next`, `current_component`, and `seek` methods to traverse the members in the structure. Methods are provided for setting and obtaining the structure's members.

## DynUnion

The `DynUnion` interface represents a union and contains two components. The first component represents the discriminator and the second represents the member value.

You may use the `rewind`, `next`, `current_component`, and `seek` methods to traverse the components. Methods are provided for setting and obtaining the union's discriminator and member value.

## DynSequence and DynArray

A `DynSequence` or `DynArray` represents a sequence of basic or constructed data types without the need of generating a separate `DynAny` object for each component in the sequence or array. The number of components in a `DynSequence` may be changed, while the number of components in a `DynArray` is fixed.

You can use the `rewind`, `next`, `current_component`, and `seek` methods to traverse the members in a `DynArray` or `DynSequence`.

## DynAny example IDL

The following code sample shows the IDL used in the example client and server applications. The `StructType` structure contains two basic data types and an enumeration value. The `PrinterManager` interface is used to display the contents of an `Any` without any static information about the data type it contains.

```
// Printer.idl
module Printer {
    enum EnumType {first, second, third, fourth};
    struct StructType {
        string str;
        EnumType e;
        float fl;
    };
    interface PrinterManager {
        void printAny(in any info);
        oneway void shutdown();
    };
};
```

## DynAny example client application

The following code sample shows a client application that can be found in the following VisiBroker distribution directory:

```
<install_dir>\examples\vbroker\dynany\
```

The client application uses the `DynStruct` interface to dynamically create a `StructType` structure.

The `DynStruct` interface uses a sequence of `NameValuePair` objects to represent the structure members and their corresponding values. Each name-value pair consists of a string containing the structure member's name and an `Any` object containing the structure member's value.

After initializing the VisiBroker ORB in the usual manner and binding to a `PrintManager` object, the client performs the following steps:

- 1 Creates an empty `DynStruct` with the appropriate type.
- 2 Creates a sequence of `NameValuePair` objects that will contain the structure members.
- 3 Creates and initializes `Any` objects for each of the structure member's values.
- 4 Initializes each `NameValuePair` with the appropriate member name and value.
- 5 Initializes the `DynStruct` object with the `NameValuePair` sequence.
- 6 Invokes the `PrinterManager.printAny` method, passing the `DynStruct` converted to a regular `Any`.

**Note**

You must use the `DynAny.to_any` method to convert a `DynAny` object, or one of its derived types, to an `Any` before passing it as a parameter on an operation request.

The following code sample is an example of a client application that uses `DynStruct`:

```
// Client.java
import org.omg.DynamicAny.*;
public class Client {
    public static void main(String[] args) {
        try {
            // Initialize the ORB.
            org.omg.CORBA.ORB orb = org.omg.CORBA.ORB.init(args,
null);
            DynAnyFactory factory =
                DynAnyFactoryHelper.narrow(

orb.resolve_initial_references("DynAnyFactory"));
            // Locate a printer manager.
            Printer.PrinterManager manager =
                Printer.PrinterManagerHelper.bind(orb,
"PrinterManager");
            // Create Dynamic struct
            DynStruct info =

DynStructHelper.narrow(factory.create_dyn_any_from_type_co
de
                (Printer.StructTypeHelper.type()));
            // Create our NameValuePair sequence (array)
            NameValuePair[] NVPair = new NameValuePair[3];
            // Create and initialize Dynamic Struct data as
any's
            org.omg.CORBA.Any str_any = orb.create_any();
            str_any.insert_string("String");
            org.omg.CORBA.Any e_any = orb.create_any();
            Printer.EnumTypeHelper.insert(e_any,
Printer.EnumType.second);
            org.omg.CORBA.Any fl_any = orb.create_any();
            fl_any.insert_float((float)864.50);
            NVPair[0] = new NameValuePair("str", str_any);
            NVPair[1] = new NameValuePair("e", e_any);
            NVPair[2] = new NameValuePair("fl", fl_any);
            // Initialize the Dynamic Struct
            info.set_members(NVPair);
            manager.printAny(info.to_any());
            manager.shutdown();
        }
        catch (Exception e) {
            e.printStackTrace();
        }
    }
}
```

## DynAny example server application

The following code sample shows a server application that can be found in the following VisiBroker distribution directory:

```
<install_dir>\examples\vbroker\dynany\
```

The server application performs the following steps.

- 1 Initializes the VisiBroker ORB.
- 2 Creates the policies for the POA.
- 3 Creates a PrintManager object.
- 4 Exports the PrintManager object.
- 5 Prints a message and waits for incoming operation requests.

```
// Server.java
import java.util.*;
import org.omg.DynamicAny.*;
import org.omg.PortableServer.*;
import com.inprise.vbroker.PortableServerExt.*;
public class Server {
    public static void main(String[] args) {
        try {
            // Initialize the ORB.
            org.omg.CORBA.ORB orb =
org.omg.CORBA.ORB.init(args,null);
            // Resolve Root POA
            POA rootPoa =
                POAHelper.narrow(orb.resolve_initial_references(
                    "RootPOA"));
            rootPoa.the_POAManager().activate();
            // Create a BindSupport Policy that makes POA
register
            // each servant with osagent
            org.omg.CORBA.Any any = orb.create_any();
            BindSupportPolicyValueHelper.insert(any,
                BindSupportPolicyValue.BY_INSTANCE);
            org.omg.CORBA.Policy bsPolicy =

orb.create_policy(BIND_SUPPORT_POLICY_TYPE.value, any);
            // Create policies for our testPOA
            org.omg.CORBA.Policy[] policies = {

rootPoa.create_lifespan_policy(LifespanPolicyValue.PERSIST
ENT),
                bsPolicy
            };
            // Create managerPOA with the right policies
            POA serverPoa =
                rootPoa.create_POA(
                    "serverPoa",
                    rootPoa.the_POAManager(),
                    policies );
            // Resolve Dynamic Any Factory
            DynAnyFactory factory =
                DynAnyFactoryHelper.narrow(

orb.resolve_initial_references("DynAnyFactory"));
            byte[] oid = "PrinterManager".getBytes();
```

```

// Create the printer manager object.
PrinterManagerImpl manager =
    new PrinterManagerImpl((
        com.inprise.vbroker.CORBA.ORB) orb,
        factory,
        serverPoa,
        oid);
// Export the newly create object.
serverPoa.activate_object_with_id(oid, manager);
System.out.println(manager + " is ready.");
// Wait for incoming requests
orb.run();
}
catch (Exception e) {
    e.printStackTrace();
}
}
}

```

The following code sample shows how the `PrinterManager` implementation follows these steps in using a `DynAny` to process the `Any` object, without any compile-time knowledge of the type the `Any` contains.

- 1 Creates a `DynAny` object, initializing it with the received `Any`.
- 2 Performs a switch on the `DynAny` object's type.
- 3 If the `DynAny` contains a basic data type, simply prints out the value.
- 4 If the `DynAny` contains an `Any` type, creates a `DynAny` for it, determines its contents, and then prints out the value.
- 5 If the `DynAny` contains an enum, creates a `DynEnum` for it and then prints out the string value.
- 6 If the `DynAny` contains a union, creates a `DynUnion` for it and then prints out the union's discriminator and the member.
- 7 If the `DynAny` contains a struct, array, or sequence, traverses through the contained components and prints out each value.

```

// PrinterManagerImpl.java
import java.util.*;
import org.omg.DynamicAny.*;
import org.omg.PortableServer.*;
public class PrinterManagerImpl extends Printer.PrinterManagerPOA {
    private com.inprise.vbroker.CORBA.ORB _orb;
    private DynAnyFactory _factory;
    private POA _poa;
    private byte[] _oid;

    public PrinterManagerImpl(com.inprise.vbroker.CORBA.ORB orb,
        DynAnyFactory factory, POA poa, byte[] oid) {
        _orb = orb;
        _factory = factory;
        _poa = poa;
        _oid = oid;
    }

    public synchronized void printAny(org.omg.CORBA.Any info) {
        // Display info with the assumption that we don't have
        // any info statically about the type inside the any
        try {
            // Create a DynAny object
            DynAny dynAny = _factory.create_dyn_any(info);
            display(dynAny);
        }
    }
}

```

```

    }
    catch (Exception e) {
        e.printStackTrace();
    }
}
public void shutdown() {
    try {
        _poa.deactivate_object(_oid);
        System.out.println("Server shutting down");
        _orb.shutdown(false);
    }
    catch (Exception e) {
        System.out.println(e);
    }
}
private void display(DynAny value) throws Exception {
    switch(value.type().kind().value()) {
        case org.omg.CORBA.TCKind._tk_null:
        case org.omg.CORBA.TCKind._tk_void: {
            break;
        }
        case org.omg.CORBA.TCKind._tk_short: {
            System.out.println(value.get_short());
            break;
        }
        case org.omg.CORBA.TCKind._tk_ushort: {
            System.out.println(value.get_ushort());
            break;
        }
        case org.omg.CORBA.TCKind._tk_long: {
            System.out.println(value.get_long());
            break;
        }
        case org.omg.CORBA.TCKind._tk_ulong: {
            System.out.println(value.get_ulong());
            break;
        }
        case org.omg.CORBA.TCKind._tk_float: {
            System.out.println(value.get_float());
            break;
        }
        case org.omg.CORBA.TCKind._tk_double: {
            System.out.println(value.get_double());
            break;
        }
        case org.omg.CORBA.TCKind._tk_boolean: {
            System.out.println(value.get_boolean());
            break;
        }
        case org.omg.CORBA.TCKind._tk_char: {
            System.out.println(value.get_char());
            break;
        }
        case org.omg.CORBA.TCKind._tk_octet: {
            System.out.println(value.get_octet());
            break;
        }
        case org.omg.CORBA.TCKind._tk_string: {
            System.out.println(value.get_string());
        }
    }
}

```



```

        break;
    }
    case org.omg.CORBA.TCKind._tk_any: {
        DynAny dynAny = _factory.create_dyn_any(value.get_any());
        display(dynAny);
        break;
    }
    case org.omg.CORBA.TCKind._tk_TypeCode: {
        System.out.println(value.get_typecode());
        break;
    }
    case org.omg.CORBA.TCKind._tk_objref: {
        System.out.println(value.get_reference());
        break;
    }
    case org.omg.CORBA.TCKind._tk_enum: {
        DynEnum dynEnum = DynEnumHelper.narrow(value);
        System.out.println(dynEnum.get_as_string());
        break;
    }
    case org.omg.CORBA.TCKind._tk_union: {
        DynUnion dynUnion = DynUnionHelper.narrow(value);
        display(dynUnion.get_discriminator());
        display(dynUnion.member());
        break;
    }
    case org.omg.CORBA.TCKind._tk_struct:
    case org.omg.CORBA.TCKind._tk_array:
    case org.omg.CORBA.TCKind._tk_sequence: {
        value.rewind();
        boolean next = true;
        while(next) {
            DynAny d = value.current_component();
            display(d);
            next = value.next();
        }
        break;
    }
    case org.omg.CORBA.TCKind._tk_longlong: {
        System.out.println(value.get_longlong());
        break;
    }
    case org.omg.CORBA.TCKind._tk_ulonglong: {
        System.out.println(value.get_ulonglong());
        break;
    }
    case org.omg.CORBA.TCKind._tk_wstring: {
        System.out.println(value.get_wstring());
        break;
    }
    case org.omg.CORBA.TCKind._tk_wchar: {
        System.out.println(value.get_wchar());
        break;
    }
    default:
        System.out.println("Invalid type");
}
}
}

```



# Using valuetypes

This section explains how to use the `valuetype` IDL type in VisiBroker.

## Understanding valuetypes

The `valuetype` IDL type is used to pass state data over the wire. A *valuetype* is best thought of as a struct with inheritance and methods. Valuetypes differ from normal interfaces in that they contain properties to describe the valuetype's state, and contain implementation details beyond that of an interface.

## Valuetype IDL code sample

The following IDL code declares a simple valuetype:

```
module Map {
    valuetype Point {
        public long x;
        public long y;
        private string label;
        factory create (in long x, in long y, in string z);
        void print();
    };
};
```

Valuetypes are always local. They are not registered with the VisiBroker ORB, and require no identity, as their value is their identity. They can not be called remotely.

## Concrete valuetypes

Concrete valuetypes contain state data. They extend the expressive power of IDL structs by allowing:

- Single concrete valuetype derivation and multiple abstract valuetype derivation
- Multiple interface support (one concrete and multiple abstract)
- Arbitrary recursive valuetype definitions
- Null value semantics
- Sharing semantics

## Valuetype derivation

You can derive a concrete valuetype from one other concrete valuetype. However, valuetypes can be derived from multiple other abstract valuetypes.

## Sharing semantics

Valuetype instances can be shared by other valuetypes across or within other instances. Other IDL data types such as `struct`, `union`, or `sequence` cannot be shared. Valuetypes that are shared are *isomorphic* between the sending context and the receiving context.

In addition, when the same valuetype is passed into an operation for two or more arguments, the receiving context receives the same valuetype reference for both arguments.

### Null semantics

*Null* valuetypes can be passed over the wire, unlike IDL data types such as structs, unions, and sequences. For instance, by boxing a struct as a boxed valuetype, you can pass a null value struct. For more information, see [“Boxed valuetypes”](#).

### Factories

*Factories* are methods that can be declared in valuetypes to create valuetypes in a portable way. For more information on Factories, see [“Implementing factories”](#).

## Abstract valuetypes

*Abstract* valuetypes contain only methods and do not have state. They may not be instantiated. Abstract valuetypes are a bundle of operation signatures with a purely local implementation.

For instance, the following IDL defines an abstract valuetype `Account` that contains no state, but one method, `get_name`:

```
abstract valuetype Account{
    string get_name();
}
```

Now, two valuetypes are defined that inherit the `get_name` method from the abstract valuetype:

```
valuetype savingsAccount:Account{
    private long balance;
}
valuetype checkingAccount:Account{
    private long balance;
}
```

These two valuetypes contain a variable `balance`, and they inherit the `get_name` method from the abstract valuetype `Account`.

## Implementing valuetypes

To implement valuetypes in an application, do the following:

- 1 Define the valuetypes in an IDL file.
- 2 Compile the IDL file using `idl2java`
- 3 Implement your valuetypes by inheriting the valuetype base class.
- 4 Implement the `Factory` class to implement any factory methods defined in IDL.
- 5 Implement the `create_for_unmarshal` method.
- 6 If necessary, register your `Factory` with the VisiBroker ORB.
- 7 Either implement the `_add_ref`, `_remove_ref`, and `_ref_countvalue` methods or derive from `CORBA::DefaultValueRefCountBase`.

### Defining your valuetypes

In the IDL sample (for more information, see [“Valuetype IDL code sample”](#)), you define a valuetype named `Point` that defines a point on a graph. It

contains two public variables, the  $x$  and  $y$  coordinates, one private variable that is the label of the point, the valuetype's factory, and a print method to print the point.

## Compiling your IDL file

When you have defined your IDL, compile it using `idl2java` to create source files. You then modify the source files to implement your valuetypes.

If you compile the IDL shown in ["Valuetype IDL code sample"](#), your output consists of the following files:

- `Point.java`
- `PointDefaultFactory.java`
- `PointHelper.java`
- `PointHolder.java`
- `PointValueFactory.java`

## Inheriting the valuetype base class

After compiling your IDL, create your implementation of the valuetype. The implementation class will inherit the base class. This class contains the constructor that is called in your `ValueFactory`, and contains all the variables and methods declared in your IDL.

In the `obv\PointImpl.java`, the `PointImpl` class extends the `Point` class, which is generated from the IDL.

Inheriting the valuetype base class:

```
public class PointImpl extends Point {
    public PointImpl() {}
    public PointImpl(int a_x, int a_y, String a_label) {
        x = a_x;
        y = a_y;
        label = a_label;
    }
    public void print () {
        System.out.println("Point is [" + label + ": (" + x
+ ", " + y + ")"]);
    }
}
```

## Implementing the Factory class

When you have created an implementation class, implement the Factory for your valuetype.

In the following example, the generated `Point_init` class contains the `create` method declared in your IDL. This class extends `org.omg.CORBA.portable.ValueFactory`. The `PointDefaultFactory` class implements `PointValueFactory` as shown in the following example.

```
public class PointDefaultFactory implements
PointValueFactory {
    public java.io.Serializable read_value
(org.omg.CORBA.portable.InputStream is) {
        java.io.Serializable val = new PointImpl(); //
Called the implementation

class
    // create and initialize value
```

```

        val =
        ((org.omg.CORBA_2_3.portable.InputStream) is).read_value(va
1);
        return val;
    }
    // It is up to the user to implement the valuetype
however they want:
    public Point create (int x,
        int y,
        java.lang.String z) {
        // IMPLEMENT:
        return null;
    }
}

```

`PointImpl()` is called to create a new valuetype, which is read in from the `InputStream` by `read_value`.

You must call `read_value` or your Factory will not work, and you may not call any other method.

## Registering your Factory with the VisiBroker ORB

To register your Factory with the VisiBroker ORB, call `ORB.register_value_factory`. This is required only if you do not name your factory `valuetypernameDefaultFactory`. For more information on registering Factories, see [“Registering valuetypes”](#).

## Implementing factories

When the VisiBroker ORB receives a valuetype, it must first be demarshaled, and then the appropriate factory for that type must be found in order to create a new instance of that type. Once the instance has been created, the value data is unmarshaled into the instance. The type is identified by the `RepositoryID` that is passed as part of the invocation. The mapping between the type and the factory is language specific.

VisiBroker version 4.5 or later version will generate the correct signatures for either the JDK 1.3 or JDK 1.4 default value factory method. Existing (version 4.0) generated code is not designed to run under JDK 1.3, unless you modify the default value factory method signature as shown below. If you use your existing code with JDK 1.3 and do not modify default value factory, the code will not compile or will throw a `NO_IMPLEMENT` exception. Consequently, we recommend that you regenerate your code to generate the correct signatures.

The following code sample shows how you should modify the default value factory method signature to make sure that it compiles under JDK 1.3:

```

public class PointDefaultFactory implements
PointValueFactory {
    public java.io.Serializable read_value (
        org.omg.CORBA_2_3.portable.InputStream is) {
        java.io.Serializable val = new PointImpl();
        // create and initialize value
        // It is very important that this call is made.
        val =
        ((org.omg.CORBA_2_3.portable.InputStream) is).read_value(va
1);
    }
}

```

```

        return val;
    }
    public Point create (int x, int y, java.lang.String z)
    {
        // IMPLEMENT:
        return NO_IMPLEMENT;
    }
}

```

## Factories and valuetypes

When the VisiBroker ORB receives a valuetype, it will look for that type's factory. It will look for a factory named `<valuetype>DefaultFactory`. For instance, the Point valuetype's factory is called `PointDefaultFactory`. If the correct factory doesn't conform to this naming schema (`<valuetype>DefaultFactory`), you must register the correct factory so the VisiBroker ORB can create an instance of the valuetype.

If the VisiBroker ORB cannot find the correct factory for a given valuetype, a `MARSHAL` exception is raised, with an identified minor code.

## Registering valuetypes

Each language mapping specifies how and when registration occurs. If you created a factory with the `<valuetype>DefaultFactory` naming convention, this is considered implicitly registering that factory, and you do not need to explicitly register your factory with the VisiBroker ORB.

To register a factory that does not conform to the `<valuetype>DefaultFactory` naming convention, call `register_value_factory`. To unregister a factory, call `unregister_value_factory` on the VisiBroker ORB. You can also lookup a registered valuetype factory by calling `lookup_value_factory` on the VisiBroker ORB.

## Boxed valuetypes

*Boxed* valuetypes allow you to wrap non-value IDL data types as valuetypes. For example, the following IDL boxed valuetype declaration,

```
valuetype Label string;
```

is equivalent to this IDL valuetype declaration:

```
valuetype Label{
    public string name;
}

```

By boxing other data types as valuetypes, it allows you to use valuetype's null semantics and sharing semantics.

Valueboxes are implemented purely with generated code. No user code is required.

## Abstract interfaces

Abstract interfaces allow you to choose at runtime whether the object will be passed by value or by reference.

Abstract interfaces differ from IDL interfaces in the following ways:

- The actual parameter type determines whether the object is passed by reference or a valuetype is passed. The parameter type is determined based on two rules. It is treated as an object reference if it is a regular interface type or sub-type, the interface type is a sub-type of the signature abstract interface type, and the object is already registered with the VisiBroker ORB. It is treated as a value if it can not be passed as an object reference, but can be passed as a value. If it fails to pass as a value, a `BAD_PARAM` exception is raised.
- Abstract interfaces do not implicitly derive from `org.omg.CORBA.Object` because they can represent either object references or valuetypes. Valuetypes do not necessarily support common object reference operations. If the abstract interface can be successfully narrowed to an object reference type, you can invoke the operations of `org.omg.CORBA.Object`.
- Abstract interfaces may only inherit from other abstract interfaces.
- Valuetypes can support one or more abstract interfaces.

For example, examine the following abstract interface.

```
abstract interface ai{
};
interface itp : ai{
};
valuetype vtp supports ai{
};
interface x {
    void m(ai aitp);
};
valuetype y {
    void op(ai aitp);
};
```

For the argument to method `m`:

- `itp` is always passed as an object reference.
- `vtp` is passed as a value.

## Custom valuetypes

By declaring a custom valuetype in IDL, you bypass the default marshalling and unmarshalling model and are responsible for encoding and decoding.

```
custom valuetype customPoint{
    public long x;
    public long y;
    private string label;
    factory create(in long x, in long y, in string z);
};
```

You must implement the `marshal` and `unmarshal` methods from the `CustomMarshal` interface.

When you declare a custom valuetype, the valuetype extends `org.omg.CORBA.portable.CustomValue`, as opposed to `org.omg.CORBA.portable.StreamableValue`, as in a regular valuetype. The compiler does not generate `read` or `write` methods for your valuetype.

You must implement your own `read` and `write` methods by using `org.omg.CORBA.portable.DataInputStream` and `org.omg.CORBA.portable.DataOutputStream` to read and write the values, respectively.



## Truncatable valuetypes

*Truncatable* valuetypes allow you to treat an inherited valuetype as its parent.

The following IDL defines a valuetype `checkingAccount` that is inherited from the base type `Account` and can be truncated in the receiving object.

```
valuetype checkingAccount: truncatable Account{  
    private long balance;  
}
```

This is useful if the receiving context doesn't need the new data members or methods in the derived valuetype, and if the receiving context isn't aware of the derived valuetype. However, any state data from the derived valuetype that isn't in the parent data type will be lost when the valuetype is passed to the receiving context.

### Note

You cannot make a custom valuetype truncatable.



# Using URL naming

This section explains how to use the URL Naming Service which allows you to associate a URL (Uniform Resource Locator) with an object's IOR (Interoperable Object Reference). Once a URL has been bound to an object, client applications can obtain a reference to the object by specifying the URL as a string instead of the object's name. If you want client applications to locate objects without using the osagent or a CORBA Naming Service, specifying a URL is an alternative.

## URL Naming Service

The URL Naming Service is a simple mechanism that lets a server object associate its IOR with a URL in the form of a string in a file. Client programs can then locate the object using the URL pointing to the file containing the stringified URL on the web server. The URL Naming Service supports the `http` URL scheme for registering objects and locating an object by the URL.

This URL name service provides a way to locate objects without using the Smart Agent or a CORBA Naming Service. It enables client applications to locate objects provided by any vendor.

### Note

The VisiBroker URL Naming supports whatever form of URL handling that your Java environment supports.

## URL Naming Service examples

The code for the URL Naming Service examples are located in your VisiBroker distribution in the following directory:

```
<install_dir>\examples\vbroker\basic\bank_URL
```

The following is the IDL specification for this service. IDL sample (WebNaming module)

```
// WebNaming.idl
#pragma prefix "borland.com"
module URLNaming {
    exception InvalidURL{string reason;};
    exception CommFailure{string reason;};
    exception ReqFailure{string reason;};
    exception AlreadyExists{string reason;};
    abstract interface Resolver {
        // Read Operations
        Object locate(in string url_s)
            raises (InvalidURL, CommFailure,
ReqFailure);
        // Write Operations
        void force_register_url(in string url_s, in Object
obj)
            raises (InvalidURL, CommFailure,
ReqFailure);
        void register_url(in string url_s, in Object obj)
            raises (InvalidURL, CommFailure,
ReqFailure, AlreadyExists);
    };
};
```

## Registering objects

Object servers register objects by binding to the Resolver and then using the `register_url` or the `force_register_url` method to associate a URL with an object's IOR. `register_url` is used to associate a URL with an object's IOR if no prior association exists. Using the `force_register_url` method associates a URL with an object's IOR regardless of whether an URL has already been bound to that object. If you use the `register_url` method under the same circumstances, an `AlreadyExists` exception is raised.

For an example illustrating the server-side use of this feature, see [“URL Naming Service examples”](#). This example uses `force_register_url`. For `force_register_url` to be successful, the web server must be allowed to issue HTTP PUT commands.

### Note

To get a reference to the Resolver, use the VisiBroker ORB's `resolve_initial_references` method, as shown in the example.

```

...
public class Server {
    public static void main(String[] args) {
        if (args.length == 0) {
            System.out.println("Usage: vbj Server <URL
string>");
            return;
        }
        String url = args[0];
        try {
            // Initialize the ORB.
            org.omg.CORBA.ORB orb =
org.omg.CORBA.ORB.init(args,null);
            // get a reference to the root POA
            POA rootPoa =

POAHelper.narrow(orb.resolve_initial_references("RootPOA")
);
            // Create the servant
            AccountManagerImpl managerServant = new
AccountManagerImpl();
            // Decide on the ID for the servant
            byte[] managerId = "BankManager".getBytes();
            // Activate the servant with the ID on myPOA
            rootPoa.activate_object_with_id(managerId,
managerServant);
            // Activate the POA manager
            rootPoa.the_POAManager().activate();
            // Create the object reference
            org.omg.CORBA.Object manager =

rootPoa.servant_to_reference(managerServant);
            // Obtain the URLNaming Resolver
            Resolver resolver = ResolverHelper.narrow(

orb.resolve_initial_references("URLNamingResolver"));
            // Register the object reference (overwrite if
exists)
            resolver.force_register_url(url, manager);
            System.out.println(manager + " is ready.");
            // Wait for incoming requests
            orb.run();

```

```

    } catch (Exception e) {
        e.printStackTrace();
    }
}
}

```

In this code sample `args[0]` is of the form:

```

http://<host_name>:<http_server_port>/<ior_file_path>/
<ior_file_name>

```

The `ior_file_name` is the user-specified file name where the stringified object reference is stored. The suffix of the `ior_file_name` must be `.ior` if the Gatekeeper will be used instead of an HTTP server. An example using the Gatekeeper and its default port number is as follows:

```

http://mars:15000/URLNaming/Bank_Manager.ior

```

## Locating an object by URL

Client applications do not need to bind to the `Resolver`, they simply specify the URL when they call the `bind` method, as shown in the following code sample. The `bind` accepts the URL as the object name. If the URL is invalid, an `InvalidURL` exception is raised. The `bind` method transparently calls `locate()` for you.

```

// ResolverClient.java
import com.inprise.vbroker.URLNaming.*;
public class ResolverClient {
    public static void main(String[] args) {
        if (args.length == 0) {
            System.out.println("Usage: vbj Client <URL
string> [Account name]");
            return;
        }
        String url = args[0];
        try {
            // Initialize the ORB.
            org.omg.CORBA.ORB orb =
org.omg.CORBA.ORB.init(args,null);

```

For an example of how to use `locate()`, see the following code sample.

```

        // Obtain the URLNaming Resolver
        Resolver resolver = ResolverHelper.narrow(

orb.resolve_initial_references("URLNamingResolver"));
        // Locate the object
        Bank.AccountManager manager =

Bank.AccountManagerHelper.narrow(resolver.locate(url));
        // use args[0] as the account name, or a default.
        String name = args.length > 1 ? args[1] : "Jack
B. Quick";
        // Request the account manager to open a named
account.
        Bank.Account account = manager.open(name);
        // Get the balance of the account.
        float balance = account.balance();
        // Print out the balance.
        System.out.println("The balance in " + name + "'s
account is $" + balance);
    } catch (Exception e) {

```

```

        e.printStackTrace();
    }
}

```

Obtaining an object reference using the `Resolver.locate` method:

```

// Client.java
public class Client {
    public static void main(String[] args) {
        if (args.length == 0) {
            System.out.println("Usage: vbj Client <URL
string> [Account name]");
            return;
        }
        String url = args[0];
        // Initialize the ORB.
        org.omg.CORBA.ORB orb =
org.omg.CORBA.ORB.init(args,null);
        // Locate the object
        Bank.AccountManager manager =
Bank.AccountManagerHelper.bind(orb, url);
        // use args[0] as the account name, or a default.
        String name = args.length > 1 ? args[1] : "Jack B.
Quick";
        // Request the account manager to open a named
account.
        Bank.Account account = manager.open(name);
        // Get the balance of the account.
        float balance = account.balance();
        // Print out the balance.
        System.out.println("The balance in " + name + "'s
account is $" + balance);
    }
}

```

# Bidirectional Communication

This section explains how to establish bidirectional connections in VisiBroker without using the GateKeeper. For information about bidirectional communications when using GateKeeper, see the *VisiBroker GateKeeper Guide*.

## Note

Before enabling bidirectional IIOP, read about [“Security considerations”](#).

## Using bidirectional IIOP

Most clients and servers that exchange information by way of the Internet are typically protected by corporate firewalls. In systems where requests are initiated only by the clients, the presence of firewalls is usually transparent to the clients. However, there are cases where clients need information *asynchronously*, that is, information must arrive that is not in response to a request. Client-side firewalls prevent servers from initiating connections back to clients. Therefore, if a client is to receive asynchronous information, it usually requires additional configuration.

In earlier versions of IIOP and VisiBroker, the only way to make it possible for a server to send asynchronous information to a client was to use a client-side GateKeeper to handle the callbacks from the server.

If you use bidirectional IIOP, rather than having servers open separate connections to clients when asynchronous information needs to be transmitted back to clients (these would be rejected by client-side firewalls anyway), servers use the client-initiated connections to transmit information to clients. The CORBA specification also adds a new policy to portably control this feature.

Because bidirectional IIOP allows callbacks to be set up without a GateKeeper, it greatly facilitates deployment of clients.

## Bidirectional VisiBroker ORB properties

The following properties provide bidirectional support:

- [enableBiDir property](#)
- [exportBiDir property](#)
- [importBiDir property](#)

### **enableBiDir property**

The `vbroker.orb.enableBiDir` property can be used on both the server and the client to enable bidirectional communication. This property allows you to change an existing unidirectional application into a bidirectional one without changing any code.

The following table describes the `vbroker.orb.enableBiDir` property value options:

Value	Description
<code>client</code>	Enables bidirectional IIOP for all POAs and for all outgoing connections. This setting is equivalent to creating all POAs with a setting of the BiDirectional policy to <code>both</code> and setting the policy override for the BiDirectional policy to <code>both</code> on the VisiBroker ORB level. Furthermore, all created SCMs will permit bidirectional connections, as if the <code>exportBiDir</code> property had been set to <code>true</code> for every SCM.
<code>server</code>	Causes the server to accept and use connections that are bidirectional. This is equivalent to setting the <code>importBiDir</code> property on all SCMs to <code>true</code> .
<code>both</code>	Sets the property to both <code>client</code> and <code>server</code> .
<code>none</code>	Disables bidirectional IIOP altogether. This is the default value.

### exportBiDir property

The `vbroker.se.<se-name>.scm.<scmname>.manager.exportBiDir` property is a client-side property. By default, it is not set to anything by the VisiBroker ORB.

Setting it to `true` enables creation of a bidirectional callback POA on the specified server engine.

Setting it to `false` disables creation of a bidirectional POA on the specified server engine.

### importBiDir property

The `vbroker.se.<se-name>.scm.<scm-name>.manager.importBiDir` property is a server-side property. By default, it is not set to anything by the VisiBroker ORB.

Setting it to `true` allows the server-side to reuse the connection already established by the client for sending requests to the client.

Setting it to `false` prevents reuse of connections in this fashion.

### Note

These properties are evaluated only once—when the SCMs are created. In all cases, the `exportBiDir` and `importBiDir` properties on the SCMs govern the `enableBiDir` property. In other words, if both properties are set to conflicting values, the SCM-specific properties take effect. This allows you to set the `enableBiDir` property globally and specifically turn off BiDir in individual SCMs.

## About the BiDirectional examples

Examples demonstrating use of this feature are installed as part of your VisiBroker distribution in subdirectories in the following location:

```
<install_dir>\examples\vbroker\bidir-iiop
```

All the examples are based on a simple stock quote callback application:

- 1 The client creates a CORBA object that processes stock quote updates.
- 2 The client sends the object reference of this CORBA object to the server.
- 3 The server invokes this callback object to periodically update stock quotes.



In the sections that follow, these examples are used to explain different aspects of the bidirectional IIOp feature.

## Enabling bidirectional IIOp for existing applications

You can enable bidirectional communication in existing VisiBroker for Java applications without modifying any source code. A simple callback application that does not use bidirectional IIOp at all is located in the following directory:

```
<install_dir>\examples\vbroker\bidir-iioP\basic
```

To enable bidirectional IIOp for the callback example, you set the `vbroker.orb.enableBiDir` property as follows:

- 1 Make sure the osagent is running.
- 2 Start the server.

### UNIX

```
prompt> vbj -Dvbroker.orb.enableBiDir=server Server &
```

### Windows

```
prompt> start vbj -Dvbroker.orb.enableBiDir=server  
Server
```

- 3 Start the client.

```
prompt> vbj -Dvbroker.orb.enableBiDir=client  
RegularClient
```

The existing callback application now uses bidirectional IIOp and works through a client-side firewall.

## Explicitly enabling bidirectional IIOp

The client in directory `<install_dir>\examples\vbroker\bidir-iioP\basic` is derived from the `RegularClient` described in [“Enabling bidirectional IIOp for existing applications”](#), except that this client enables bidirectional IIOp programmatically.

The changes required are in the client code only. To convert the unidirectional client into a bidirectional client, all you need to do is:

- 1 Include the `BiDirectional` policy in the list of policies for the callback POA.
- 2 Add the `BiDirectional` policy to the list of overrides for the object reference that refers to the server for which we want to enable bidirectional IIOp.
- 3 Set the `exportBiDir` property to `true` in the client.

In the following code sample, the code that implements bidirectional IIOP is displayed in bold:

```

public static void main (String[] args) {
    try {
        org.omg.CORBA.ORB orb = org.omg.CORBA.ORB.init(args,
        null);
        org.omg.PortableServer.POA rootPoa =
            org.omg.PortableServer.POAHelper.narrow(
                orb.resolve_initial_references("RootPOA"));
        org.omg.CORBA.Any bidirPolicy = orb.create_any();
        bidirPolicy.insert_short(BOTH.value);
        org.omg.CORBA.Policy[] policies = {
            //set bidir policy
            orb.create_policy(BIDIRECTIONAL_POLICY_TYPE.value,
bidirPolicy)
        };
        org.omg.PortableServer.POA callbackPOA =
            rootPoa.create_POA("bidir",
        rootPoa.the_POAManager(), policies);
        QuoteConsumerImpl c = new QuoteConsumerImpl();
        callbackPOA.activate_object(c);
        callbackPOA.the_POAManager().activate();
        QuoteServer serv =
            QuoteServerHelper.bind(orb, "/QuoteServer_poa",
                "QuoteServer".getBytes());

        serv=QuoteServerHelper.narrow(serv._set_policy_override(
            policies,
        org.omg.CORBA.SetOverrideType.ADD_OVERRIDE));
        serv.registerConsumer(QuoteConsumerHelper.narrow(
            callbackPOA.servant_to_reference(c));
        System.out.println("Client: consumer registered");
        //sleeping for 60 seconds, receiving message
        try{
            Thread.currentThread().sleep(60*1000);
        }
        catch(java.lang.InterruptedExcepTion e){ }
        serv.unregisterConsumer(QuoteConsumerHelper.narrow(
            callbackPOA.servant_to_reference(c));
        System.out.println("Client: consumer unregistered.
        Good bye.");
        orb.shutdown(true);
        ...
    }
}

```

## Unidirectional or bidirectional connections

A client connection can be either unidirectional or bidirectional. A server can use a bidirectional connection to call back the client without opening a new connection. Otherwise, the connection is considered unidirectional.

## Enabling bidirectional IIOP for POAs

The POA on which the callback object is hosted must enable bidirectional IIOP by setting the BiDirectional policy to BOTH. This POA must be created on an SCM which has been enabled for bidirectional support by setting the `vbroker.<sename>.scm.<scmname>.manager.exportBiDir` property on

the SCM manager. Otherwise, the POA will not be able to receive requests from the server over a client-initiated connection.

If a POA does not specify the BiDirectional policy, it must not be exposed in outgoing connections. To satisfy this requirement, a POA which does not have the BiDirectional policy set cannot be created on a server engine which has even one SCM whose `exportBiDir` property is set. If an attempt is made to create a POA on a unidirectional SE, an `InvalidPolicy` exception is raised, with the `ServerEnginePolicy` in error.

### Note

Different objects using the same client connection may set conflicting overrides for the BiDirectional policy. Nevertheless, once a connection is made bidirectional, it always remains bidirectional, regardless of the policy effective at a later time.

Once you have full control over the bidirectional configuration, you enable bidirectional IIOp on the `iiop_tp` SCM only:

```
prompt> vbj -
Dvbroker.se.iiop_tp.scm.iiop_tp.manager.exportBiDir=
true Client
```

## Security considerations

Use of bidirectional IIOp may raise significant security issues. In the absence of other security mechanisms, a malicious client may claim that its connection is bidirectional for use with any host and port it chooses. In particular, a client may specify the host and port of security-sensitive objects not even resident on its host. In the absence of other security mechanisms, a server that has accepted an incoming connection has no way to discover the identity or verify the integrity of the client that initiated the connection. Further, the server might gain access to other objects accessible through the bidirectional connection. This is why use of a separate, bidirectional SCM for callback objects is encouraged. If there are any doubts as to the integrity of the client, it is recommended that bidirectional IIOp not be used.

For security reasons, a server running VisiBroker will not use bidirectional IIOp unless explicitly configured to do so. The property `vbroker.<se>.<sename>.scm.<scmname>.manager.importBiDir` gives you control of bidirectionality on a per-SCM basis. For example, you might choose to enable bidirectional IIOp only on a server engine that uses SSL to authenticate the client, and to not make other, regular IIOp connections available for bidirectional use. (See [“Bidirectional VisiBroker ORB properties”](#) for more information.) In addition, on the client-side, you might want to enable bidirectional connections only to those servers that do callbacks outside of the client firewall. To establish a high degree of security between the client and server, you should use SSL with mutual authentication (set `vbroker.security.peerAuthenticationMode` to `REQUIRE_AND_TRUST` on both the client and server).



# Using the BOA with VisiBroker

This section describes how to use the BOA with VisiBroker.

## Note

BOA support is provided as backward compatibility for VisiBroker version 4.0 (CORBA spec. 2.1) and 3.x versions. For current CORBA specification support, see [“Using POAs”](#).

## Compiling your BOA code with VisiBroker

If you have existing BOA code that you developed with a previous version of VisiBroker, you can continue to use it with the current version as long as you keep the following in mind:

- To generate the necessary BOA base code, you must use the “-boa” option with the `idl2java` tool. For more information on using `idl2java` to generate the code, see [“Using the BOA with VisiBroker”](#).
- Because the `BOA_init()` is no longer available under `org.omg.CORBA.ORB`, you must cast the VisiBroker ORB to `com.inprise.vbroker.CORBA.ORB`.
- Because the `BOA` class is no longer available in the `org.omg.CORBA` package, you must now refer to it in the `com.inprise.vbroker.CORBA` package. For more information on the VisiBroker ORB package, see the [VisiBroker for Java APIs](#) documentation.

## Supporting BOA options

All BOA command line options supported by VisiBroker 4.x are still supported.

## Limitations in using the BOA

Two features are not supported with VisiBroker 4.x BOA:

- Persistent DSI objects are not supported.
- `_boa()` on DSI objects is not supported.

## Using object activators

BOA object activators are supported by VisiBroker. However, these activators can be used only with BOA, not POA. The POA uses servant activators and servant locators in place of object activators.

In this release of VisiBroker, the Portable Object Adaptor (POA) supports the features that were provided by the BOA in VisiBroker 3.x releases. For backward compatibility reasons, you may still use the object activators with your code.

## Naming objects under the BOA

Though the BOA is deprecated in VisiBroker, you may still use it in conjunction with the Smart Agent to specify a name for your server objects which may be bound to in your client programs.

### Object names

When creating an object, a server must specify an object name if the object is to be made available to client applications through the `osagent`. When the server calls the `BOA.obj_is_ready` method, the object's interface name will only be registered with the VisiBroker `osagent` if the object is named. Objects that are given an object name when they are created return *persistent* object references, while objects which are not given object names are created as *transient*.

The use of an object name by your client application is required if it plans to bind to more than one instance of an object at a time. The object name distinguishes between multiple instances of an interface. If an object name is not specified when the `bind()` method is called, the `osagent` will return any suitable object with the specified interface.

### Notes

- If you pass an empty string for the object name to the object constructor in VisiBroker for Java, a transient object is created (an object which is not registered with the Smart Agent). If you pass a null reference to the constructor, a transient object is created.
- In VisiBroker 3.x, it was possible to have a server process that provided different interfaces, all of which had the same object name, but in the current version of VisiBroker, different interfaces may not have string-equivalent names.

# Using object activators

This section describes how to use the VisiBroker object activators.

In this release, as well as the VisiBroker 4.1 release and later, the Portable Object Adaptor (POA) supports the features that were provided by the BOA in the VisiBroker 3.x and 4.0 releases. For backward compatibility reasons, you may still use the object activators as described in this section with your code. For more information on how to use the BOA activators with this release, see [“Using the BOA with VisiBroker”](#).

## Deferring object activation

You can defer activation of multiple object implementations using service activation with a single `Activator` when a server needs to provide implementations for a large number of objects.

## Activator interface

You can derive your own interface from the `Activator` class. This allows you to implement the `activate` and `deactivate` methods that the VisiBroker ORB will use for the `DObjectImpl` object. You can then delay the instantiation of the `DObjectImpl` object until the BOA receives a request for that object. It also allows you to provide clean-up processing when the BOA deactivates the object.

This code sample shows the `Activator` interface, which provide methods invoked by the BOA to activate and deactivate an VisiBroker ORB object.

```
package com.inprise.vbroker.extension;
public interface Activator extends
org.omg.CORBA.portable.IDLEntity {
    public org.omg.CORBA.Object activate(ImplementationDef
impl);
    public void deactivate(org.omg.CORBA.Object obj,
ImplementationDef impl);
}
```

The following code sample shows you how to create an `Activator` for the `DObjectImpl` interface.

```
// Server.java
import com.inprise.vbroker.extension.*;
...
class DBActivator implements Activator {
    private static int _count;
    private com.inprise.vbroker.CORBA.BOA _boa;
    public DBActivator(com.inprise.vbroker.CORBA.BOA boa) {
        _boa = boa;
    }
    public org.omg.CORBA.Object activate(
        com.inprise.vbroker.extension.ImplementationDef
impl) {
        System.out.println("Activator called " + ++_count +
" times");
        byte[] ref_data = ((ActivationImplDef) impl).id();
        DObjectImpl obj = new DObjectImpl(new
String(ref_data));
```

```

        _boa.obj_is_ready(obj);
        return obj;
    }
    public void deactivate(org.omg.CORBA.Object obj,
        com.inprise.vbroker.extension.ImplementationDef impl) {
        // nothing to do here...
    }
}
...

```

## Using the service activation approach

Service activation can be used when a server needs to provide implementations for a large number of objects (commonly thousands of objects, possibly millions) but only a small number of implementations need to be active at any specific time. The server can supply a single `Activator` which is notified whenever any of these subsidiary objects are needed. The server can also deactivate these objects when they are not in use.

For example, you might use service activation for a server that loads object implementations whose states are stored in a database. The `Activator` is responsible for loading all objects of a given type or logical distinction. When VisiBroker ORB requests are made on the references to these objects, the `Activator` is notified and creates a new implementation whose state is loaded from the database. When the `Activator` determines that the object should no longer be in memory and, if the object had been modified, it writes the object's state to the database and releases the implementation.

**Figure 39** Process of Deferring Activation for a Service

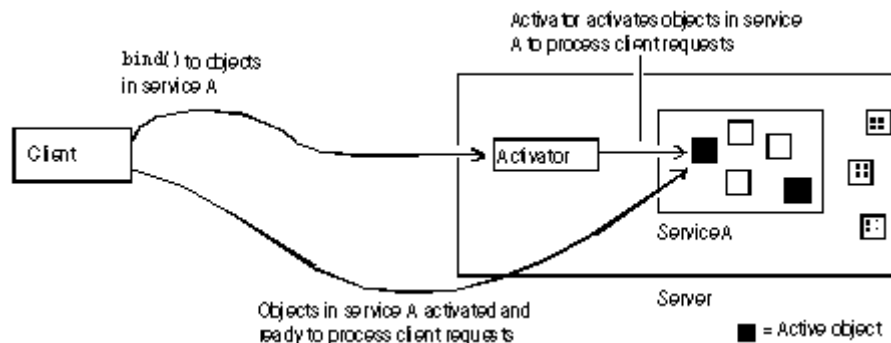

## Deferring object activation using service activators

Assuming the objects that will make up the service have already been created, the following steps are required to implement a server that uses service activation:

- 1 Define a service name that describes all objects activated and deactivated by the `Activator`.
- 2 Provide implementations for the interface which are service objects, rather than persistent objects. This is done when the object constructs itself as an activatable part of a service.
- 3 Implement the `Activator` which creates the object implementations on demand. In the implementation, you derive an `Activator` interface from `extension::Activator`, overriding the `activate` and `deactivate` methods.



4 Register the service name and the Activator interface with the BOA.

## Example of deferred object activation for a service

The following sections describe the `odb` example for service activation which is located in the following VisiBroker directory:

```
<install_dir>/examples/vbroker/boa/odb
```

This directory contains the following files:

Name	Description
<code>odb.idl</code>	IDL for DB and DBObject interfaces.
<code>Server.j</code> <code>ava</code>	Creates objects using service activators, returns IORs for the objects, and deactivates the objects.
<code>Creator.</code> <code>java</code>	Calls the DB interface to create 100 objects and stores the resulting stringified object references in a file ( <code>objref.out</code> ).
<code>Client.j</code> <code>ava</code>	Reads the stringified object references to the objects from a file and makes calls on them, causing the activators in the server to create the objects.
<code>Makefile</code>	When <code>make</code> or <code>nmake</code> (on Windows) is invoked in the <code>odb</code> subdirectory, builds the following client and server programs: <code>Server</code> , <code>Creator</code> , and <code>Client</code> .

The `odb` example shows how an arbitrary number of objects can be created by a single service. The service alone is registered with the BOA, instead of each individual object, with the reference data for each object stored as part of the IOR. This facilitates object-oriented database (OODB) integration, since you can store object keys as part of an object reference. When a client calls for an object that has not yet been created, the BOA calls a user-defined `Activator`. The application can then load the appropriate object from persistent storage.

In this example, an `Activator` is created that is responsible for activating and deactivating objects for the service named "DBService." References to objects created by this `Activator` contain enough information for the VisiBroker ORB to relocate the `Activator` for the `DBService` service, and for the `Activator` to recreate these objects on demand.

The `DBService` service is responsible for objects that implement the `DBObject` interface. An interface (contained in `odb.idl`) is provided to enable manual creation of these objects.

### odb.idl interface

The `odb.idl` interface enables manual creation of objects that implement the `DBObject` `odb` interface.

```
interface DBObject {
    string get_name();
};
typedef sequence<DBObject> DBObjectSequence;
interface DB {
    DBObject create_object(in string name);
};
```

The `DBObject` interface represents an object created by the `DB` interface, and can be treated as a service object.

`DBObjectSequence` is a sequence of `DBObject`s. The server uses this sequence to keep track of currently active objects.

The DB interface creates one or more DBObjects using the `create_object` operation. The objects created by the DB interface can be grouped together as a service.

## Implementing a service activator

Normally, an object is activated when a server instantiates the classes implementing the object, and then calls `obj_is_ready` followed by `impl_is_ready`. To defer activation of objects, it is necessary to gain control of the `activate` method that the BOA invokes during object activation. You obtain this control by deriving a new class from `com.inprise.vbroker.extension.Activator` and overriding the `activate` method, using the overridden `activate` method to instantiate classes specific to the object.

In the `odbc` example, the `DBActivator` class derives from `com.inprise.vbroker.extension.Activator`, and overrides the `activate` and `deactivate` methods. The `DBObject` is constructed in the `activate` method.

The following code sample is an example of overriding `activate` and `deactivate`.

```
// Server.java
class DBActivator implements Activator {
    private static int _count;
    private com.inprise.vbroker.CORBA.BOA _boa;
    public DBActivator(com.inprise.vbroker.CORBA.BOA boa) {
        _boa = boa;
    }
    public org.omg.CORBA.Object activate(
        com.inprise.vbroker.extension.ImplementationDef
    impl) {
        System.out.println("Activator called " + ++_count +
            " times");
        byte[] ref_data = ((ActivationImplDef) impl).id();
        DBObjectImpl obj = new DBObjectImpl(new
        String(ref_data));
        _boa.obj_is_ready(obj);
        return obj;
    }
    public void deactivate(org.omg.CORBA.Object obj,
        ImplementationDef impl) {
        // nothing to do here...
    }
}
```

When the BOA receives a client request for an object under the responsibility of the `Activator`, the BOA invokes the `activate` method on the `Activator`. When calling this method, the BOA uniquely identifies the activated object implementation by passing the `Activator` an `ImplementationDef` parameter, from which the implementation can obtain the `ReferenceData`, the requested object's unique identifier.

The following code sample gives you an example of implementing a server activator.

```
public org.omg.CORBA.Object activate(ImplementationDef
    impl) {
    System.out.println("Activator called " + ++_count + "
    times");
    byte[] ref_data = ((ActivationImplDef) impl).id();
    DBObjectImpl obj = new DBObjectImpl(new
    String(ref_data));
```

```

    _boa.obj_is_ready(obj);
    return obj;
}

```

## Instantiating the service activator

The `DBActivator` service activator is responsible for all objects that belong to the `DBService` service. All requests for objects of the `DBService` service are directed through the `DBActivator` service activator. All objects activated by this service activator have references that inform the VisiBroker ORB that they belong to the `DBService` service.

The following code sample creates and registers the `DBActivator` service activator with an `impl_is_ready` call in the main server program.

```

public static void main(String[] args) {
    org.omg.CORBA.ORB orb = ORB.init(args, null);
    com.inprise.vbroker.CORBA.BOA boa =
    ((com.inprise.vbroker.ORB )orb).BOA_init();
    DB db = new DBImpl("Database Manager");
    boa.obj_is_ready(db);
    boa.impl_is_ready("DBService", new DBActivator(boa));
}

```

### Note

The call to `impl_is_ready` is a variation on the usual call to `impl_is_ready`. It takes two arguments:

- Service name.
- Instance of an Activator interface that will be used by the BOA to activate objects belonging to the service.

## Using a service activator to activate an object

Whenever an object is constructed, `obj_is_ready` must be explicitly invoked in `activate`. There are two calls to `obj_is_ready` in the server program. One call occurs when the server creates a service object and returns an IOR to the creator program.

```

public DBObject create_object(String name) {
    System.out.println("Creating: " + name);
    DBObject dbObject = new DBObjectImpl(name);
    _boa().obj_is_ready(dbObject, "DBService",
    name.getBytes());
    return dbObject;
}

```

The second occurrence of `obj_is_ready` is in `activate`, and this needs to be explicitly called.



# CORBA exceptions

This section provides information about CORBA exceptions that can be thrown by the VisiBroker ORB, and explains possible causes for VisiBroker throwing them.

## CORBA exception descriptions

The following table lists CORBA exceptions, and explains reasons why the VisiBroker ORB might throw them.

Exception	Explanation	Possible causes
<code>CORBA::BAD_CONTEXT</code>	An invalid context has been passed to the server.	An operation may raise this exception if a client invokes the operation, but the passed context does not contain the context values required by the operation.
<code>CORBA::BAD_INV_ORDER</code>	The necessary prerequisite operations have not been called prior to the offending operation request.	An attempt to call the <code>CORBA::Request::get_response()</code> or <code>CORBA::Request::poll_response()</code> methods may have occurred prior to actually sending the request. An attempt to call the <code>exception::get_client_info()</code> method may have occurred outside of the implementation of a remote method invocation. This function is only valid within the implementation of a remote invocation. An operation was called on the VisiBroker ORB that was already shut down.
<code>CORBA::BAD_OPERATION</code>	An invalid operation has been performed.	A server throws this exception if a request is received for an operation that is not defined on that implementation's interface. Ensure that the client and server were compiled from the same IDL. The <code>CORBA::Request::return_value()</code> method throws this exception if the request was not set to have a return value. If a return value is expected when making a DII call, be sure to set the return value type by calling the <code>CORBA::Request::set_return_type()</code> method.

Exception	Explanation	Possible causes
CORBA::BAD_PARAM	A parameter passed to the VisiBroker ORB is invalid.	<p>Sequences throw CORBA::BAD_PARAM if an access is attempted to an invalid index. Make sure you use the <code>length()</code> method to set the length of the sequence before storing or retrieving elements of the sequence.</p> <p>The VisiBroker ORB throws this exception if <b>null</b> reference is passed. An attempt may have been made to insert a <b>null</b> object reference into an <code>Any</code>.</p> <p>An attempt was made to send a value that is out of range for an enumerated data type.</p> <p>An attempt may have been made to construct a <code>TypeCode</code> with an invalid <code>kind</code> value.</p> <p>Using the DII and one way method invocations, an <code>OUT</code> argument may have been specified. An interface repository throws this exception if an argument passed into an IR object's operation conflicts with its existing settings. See the compiler errors for more information.</p>
CORBA::BAD_QOS	Quality of service cannot be supported.	Can be raised whenever an object cannot support the quality of service required by an invocation parameter that has a quality of service semantics associated with it.
CORBA::BAD_TYPECODE	The ORB has encountered a malformed type code.	
CORBA::CODESET_INCOMPATIBLE	Communication between client and server native code sets fails because the code sets are incompatible.	The code sets used by the client and server cannot work together. For instance, the client uses ISO 8859-1 and the server uses the Japanese code set.
CORBA::COMM_FAILURE	Communication is lost while an operation is in progress, after the request was sent by the client, but before the reply has been returned.	This exception is raised if communication is lost while an operation is in progress, after the request was sent by the client, but before the reply from the server has been returned to the client.
CORBA::DATA_CONVERSION	The VisiBroker ORB cannot convert the representation of marshaled data into its native representation or vice-versa.	An attempt to marshal Unicode characters with <code>Output.write_char()</code> or <code>Output.write_stringfails</code> .
CORBA::IMP_LIMIT	An implementation limit was exceeded in the VisiBroker ORB run time.	The VisiBroker ORB may have reached the maximum number of references it can hold simultaneously in an address space. The size of the parameter may have exceeded the allowed maximum. The maximum number of running clients and servers has been exceeded.
CORBA::INITIALIZE	A necessary initialization has not been performed.	The <code>ORB_init()</code> method may not have been called. All clients must call the <code>ORB_init()</code> method prior to performing any VisiBroker ORB-related operations. This call is typically made immediately upon program startup at the top of the main routine.
CORBA::INTERNAL	An internal VisiBroker ORB error has occurred.	An internal VisiBroker ORB error may have occurred. For instance, the internal data structures of the VisiBroker ORB may have been corrupted.

Exception	Explanation	Possible causes
CORBA::INTF_REPOS	An instance of the Interface Repository could not be located.	If an object implementation cannot locate an interface repository during an invocation of the <code>get_interface()</code> method, this exception will be thrown to the client. Ensure that an Interface Repository is running, and that the requested object's interface definition has been loaded into the Interface Repository.
CORBA::INV_FLAG	An invalid flag was passed to an operation.	A Dynamic Invocation Interface request was created with an invalid flag.
CORBA::INV_IDENT	An IDL identifier is syntactically invalid.	An identifier passed to the interface repository is not well formed. An illegal operation name is used with the Dynamic Invocation Interface.
CORBA::INV_OBJREF	An invalid object reference has been encountered.	The VisiBroker ORB will throw this exception if an object reference is obtained that contains no usable profiles. The <code>ORB::string_to_object()</code> method will throw this exception if the stringified object reference does not begin with the characters "IOR:".
CORBA::INV_POLICY	An invalid policy override has been encountered.	This exception can be thrown from any invocation. It can be raised when an invocation cannot be made due to an incompatibility between policy overrides that apply to the particular invocation.
CORBA::INVALID_TRANSACTION	A request carried an invalid transaction context.	This exception could be raised if an error occurred while trying to register a Resource.
CORBA::MARSHAL	Error marshaling parameter or result.	A request or reply from the network is structurally invalid. This error typically indicates a bug in either the client-side or server-side run time. For example, if a reply from the server indicates that the message contains 1000 bytes, but the actual message is shorter or longer than 1000 bytes, the VisiBroker ORB raises this exception. A <code>MARSHAL</code> exception can also be caused by using the DII or DSI incorrectly. For example, if the type of the actual parameters sent does not agree with IDL signature of an operation.
CORBA::NO_IMPLEMENT	The requested object could not be located.	Indicates that even though the operation that was invoked exists (it has an IDL definition), no implementation for that operation exists. For example, a <code>NO_IMPLEMENTATION</code> is raised when a server doesn't exist or is not running when a client initiates a bind.
CORBA::NO_MEMORY	The VisiBroker ORB runtime has run out of memory.	
CORBA::NO_PERMISSION	The caller has insufficient privileges to complete an invocation.	The <code>Object::get_implementation()</code> and <code>BOA::dispose()</code> methods throw this exception if they are called on the client side. It is only valid to call these methods within the server that activated the object implementation.  An object other than the transaction originator has attempted <code>Current::commit()</code> or <code>Current::rollback()</code> .

Exception	Explanation	Possible causes
CORBA::NO_RESOURCES	A necessary resource could not be acquired.	If a new thread cannot be created, this exception will be thrown. A server will throw this exception when a remote client attempts to establish a connection if the server cannot create a socket—for example, if the server runs out of file descriptors. The minor code contains the system error number obtained after the server's failed <code>::socket ()</code> or <code>::accept ()</code> call. A client will similarly throw this exception if a <code>::connect ()</code> call fails due to running out of file descriptors.
CORBA::NO_RESPONSE	A client attempts to retrieve the result of a deferred synchronous call, but the response for the request is not yet available.	If BindOptions are used to set timeouts, this exception is raised when send and receive calls do not occur within the specified time.
CORBA::OBJ_ADAPTER	An administrative mismatch has occurred.	A server has attempted to register itself with an implementation repository under a name that is already in use, or is unknown to the repository. The POA has raised an OBJ_ADAPTER error due to problems with the application's servant managers.
CORBA::OBJECT_NOT_EXIST	The requested object does not exist.	A server throws this exception if an attempt is made to perform an operation on an implementation that does not exist within that server. This will be seen by the client when attempting to invoke operations on deactivated implementations. For instance, if an attempt to bind to an object fails, or an auto-rebind fails, OBJECT_NOT_EXIST will be raised
CORBA::PERSIST_STORE	A persistent storage failure has occurred.	Attempts to establish a connection to a database has failed, or the database is corrupt.
CORBA::REBIND	The client has received an IOR which conflicts with QOS policies.	Thrown anytime the client gets an IOR which will conflict with the QOS policies that have been set. If the Rebind Policy has a value of NO_REBIND, NO_CONNECT, or VB_NOTIFY_REBIND and an invocation on a bound object reference results in an object forward or a location forward message.
CORBA::TIMEOUT	The VisiBroker ORB timed out an operation	When attempting to establish a connection or waiting for a request/reply, if the operation does not complete before the specified time, a TIMEOUT exception is thrown. CORBA::TIMEOUT has the following minor codes: <ul style="list-style-type: none"> <li>• 0x56420001: connection timed out (could not connect within the connection timeout)</li> <li>• 0x56420002: request timed out (could not send the request within the timeout specified)</li> <li>• 0x56420003: Reply timed out (the reply was not received within the round trip timeout specified)</li> </ul>
CORBA::TRANSACTION_REQUIRED	The request has a null transaction context, and an active transaction is required.	A method was invoked that must execute as part of a transaction, but no transaction was active on the client thread.



Exception	Explanation	Possible causes
CORBA::TRANSACTION_ROLLEDBACK	The transaction associated with a request has already been rolled back, or marked for roll back.	A requested operation could not be performed because the transaction has already been marked for rollback.
CORBA::TRANSACTION_MODE	Raised by the VisiBroker ORB, when it detects a mismatch between the TransactionPolicy in the IOR and the current transaction mode.	
CORBA::TRANSACTION_UNAVAILABLE	Raised by the VisiBroker ORB, when it cannot process a transaction service context because its connection to the Transaction Service has been abnormally terminated.	
CORBA::TRANSIENT	An error has occurred, but the VisiBroker ORB believes it is possible to retry the operation.	A communications failure may have occurred and the VisiBroker ORB is signalling that an attempt should be made to rebind to the server with which communications have failed. This exception will not occur if the BindOptions are set to false with the enable_rebind() method, or the RebindPolicy is properly set.
CORBA::UNKNOWN	The VisiBroker ORB could not determine the thrown exception.	The server throws something other than a correct exception, such as a Java runtime exception. There is an IDL mismatch between the server and the client, and the exception is not defined in the client program. In DII, if the server throws an exception not known to the client at the time of compilation and the client did not specify an exception list for the CORBA::Request. Set the property vbroker.orb.warn=2 on the server to see which runtime exception caused the problem.

System exception	Minor code	Explanation
BAD_PARAM	1	Failure to register, unregister, or lookup the value factory
BAD_PARAM	2	RID already defined in the interface repository
BAD_PARAM	3	Name already used in the context in the interface repository
BAD_PARAM	4	Target is not a valid container
BAD_PARAM	5	Name clash in inherited context
BAD_PARAM	6	Incorrect type for abstract interface
MARSHAL	1	Unable to locate value factory
NO_IMPLEMENT	1	Missing local value implementation
NO_IMPLEMENT	2	Incompatible value implementation version
BAD_INV_ORDER	1	Dependency exists in the interface repository preventing the destruction of the object
BAD_INV_ORDER	2	Attempt to destroy indestructible objects in the interface repository
BAD_INV_ORDER	3	Operation would deadlock
BAD_INV_ORDER	4	VisiBroker ORB has shut down
OBJECT_NOT_EXIST	1	Attempt to pass a deactivated (unregistered) value as an object reference

## Heuristic OMG-specified exceptions

A *heuristic* decision is a unilateral decision made by a participant in a transaction to commit or rollback updates without first obtaining the consensus outcome determined by the VisiTransact Transaction Service. See the *VisiBroker VisiTransact Guide* for more information about heuristics.

The following table lists heuristic exceptions as defined by the OMG CORBA services specification, and explains reasons why they might be thrown.

Exception	Description	Possible causes
CosTransactions::HeuristicCommit	A heuristic decision was made and all relevant updates have been committed by the Resource.	The VisiTransact Transaction Service invoked <code>rollback()</code> on a Resource object that already made a heuristic decision to commit its work. The Resource raises the <code>HeuristicCommit</code> exception to indicate its state to the VisiTransact Transaction Service.
CosTransactions::HeuristicHazard	A Resource may or may not have made a heuristic decision, and does not know if all relevant updates have been made. For updates that are known, all have been committed or rolled back. This exception takes priority over <code>HeuristicMixed</code> .	The VisiTransact Transaction Service invokes <code>commit()</code> or <code>rollback()</code> on a Resource object that may or may not have made a heuristic decision.  The Resource raises this exception to indicate to the VisiTransact Transaction Service that its own state is not entirely known. The VisiTransact Transaction Service returns this exception to the application if it does not know if all Resources have made updates.
CosTransactions::HeuristicMixed	A heuristic decision was made, and some relevant updates have been committed, and others have been rolled back.	The VisiTransact Transaction Service invokes <code>commit()</code> or <code>rollback()</code> on a Resource object that has made a heuristic decision, but not made all the relevant updates.  The Resource raises this exception to indicate to the VisiTransact Transaction Service that its state is not entirely consistent. The VisiTransact Transaction Service returns this exception to the application if it receives mixed responses from Resources.
CosTransactions::HeuristicRollback	A heuristic decision was made and all relevant updates have been rolled back by the Resource.	The VisiTransact Transaction Service invokes <code>commit()</code> on a Resource object that has made a heuristic decision to rollback its work. The Resource raises the <code>HeuristicRollback</code> exception to indicate its state to the VisiTransact Transaction Service.

## Other OMG-specified exceptions

The following table lists other exceptions as defined by the OMG CORBA services specification, and explains reasons why the VisiTransact Transaction Service might throw them. For more information see [“CORBA exceptions”](#).

Exception	Description	Possible causes
<code>CosTransactions::Inactive</code>	The transaction has already been prepared or terminated.	This exception could be raised if <code>register_synchronization()</code> is invoked after the transaction has already been prepared.
<code>CosTransactions::InvalidControl</code>	An invalid Control has been passed.	This exception is raised when <code>resume()</code> is invoked and the parameter is not a null object reference, and is also not valid in the current execution environment.
<code>CosTransactions::NotPrepared</code>	A Resource has not been prepared.	An invocation of <code>replay_completion()</code> or <code>commit()</code> on a Resource that has not yet prepared will result in this exception.
<code>CosTransactions::NoTransaction</code>	No transaction is associated with the client thread.	The <code>commit()</code> , <code>rollback()</code> , or <code>rollback_only()</code> methods may raise this exception if there is no transaction associated with the client thread at invocation.
<code>CosTransactions::NotSubtransaction</code>	The current transaction is not a subtransaction.	This exception is not raised by VisiTransact Transaction Manager since nested transactions are not supported. The <code>NoTransaction</code> exception is raised instead.
<code>CosTransactions::SubtransactionsUnavailable</code>	The client thread already has an associated transaction. The VisiTransact Transaction Service does not support nested transactions.	A subsequent <code>begin()</code> invocation was performed after a transaction was already begun. If your transactional object needs to operate within a transaction, it must first check to see if a transaction has already begun before invoking <code>begin()</code> .  The <code>create_subtransaction()</code> method was invoked, but VisiTransact Transaction Manager does not support subtransactions.
<code>CosTransactions::SynchronizationUnavailable</code>	The Coordinator does not support Synchronization objects.	This exception is not raised by VisiTransact Transaction Manager since Synchronization objects are supported.

Exception	Description	Possible causes
CosTransactions::Unavailable	The requested object cannot be provided.	<p>The Control object cannot provide the Terminator or Coordinator objects when <code>Control::get_terminator()</code> or <code>Control::get_coordinator()</code> are invoked.</p> <p>The VisiTransact Transaction Service restricts the availability of the <code>PropagationContext</code>, and will not return it upon an invocation of <code>Coordinator::get_txcontext()</code>.</p>
CORBA::WrongTransaction	<p>Raised by the ORB when returning the response to a deferred synchronous request. This exception can only be raised if the request is implicitly associated with the current transaction at the time the request was issued.</p>	<p>The <code>get_response()</code> and <code>get_next_response()</code> methods may raise this exception if the transaction associated with the request is not the same as the transaction associated with the invoking thread.</p>

---

# Web Services Overview

A Web Service is an application component that you can describe, publish, locate, and invoke over a network using standardized XML messaging. Defined by new technologies like SOAP, Web Services Description Language (WSDL), and Universal Discovery, Description and Integration (UDDI), this is a new model for creating e-business applications from reusable software modules that are accessed on the World Wide Web and also providing a means for integration of older disparate applications.

## Web Services Architecture

The standard Web Service architecture consists of the three roles that perform the web services publish, find, and bind operations:

- The *Service Provider* registers all available web services with the Service Broker.

The Service Provider hosts the web service and makes it available to clients via the Web. The Service Provider publishes the web service definition and binding information to the Universal Description, Discovery, and Integration (UDDI) registry. The Web Service Description Language (WSDL) documents contain the information about the web service, including its incoming message and returning response messages.

- The *Service Broker* publishes the web services for the Service Requestor to access. The information published describes the web service and its location. Apart from publishing the web service, it also co-ordinates in hosting the web service.

The Service Broker manages the interaction between the Service Provider and Service Requestor. The Service Broker makes available all service definitions and binding information. Currently, SOAP (an XML-based, messaging and encoding protocol format for exchange of information in a decentralized, distributed environment) is the standard for communication between the Service Requestor and Service Broker.

- The *Service Requestor* interacts with the Service Broker to find the web services. The Service Requestor can then bind or invoke the web services.

The Service Requestor is a client program that consumes the web service. The Service Requestor finds web services by using UDDI or through other means, such as email. It then binds or invokes the web service.

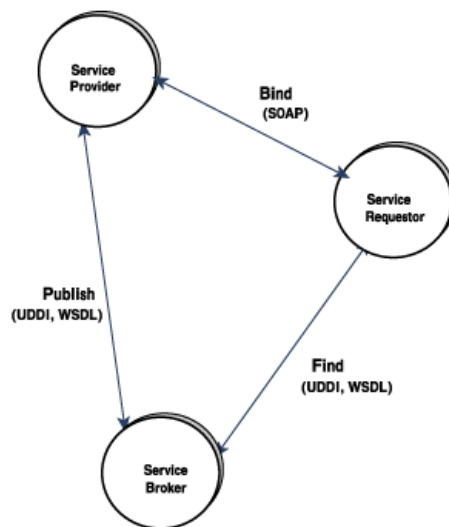
**Figure 40** Standard Web Services Architecture

## VisiBroker Web Services Architecture

There are two aspects to the architecture:

- Exposing the CORBA interface for Service Requestors to make invocations using WSDL.
- Providing a runtime environment for enabling CORBA objects to be accessible for the Service Requestors through SOAP/HTTP. This involves the infrastructure to support Services Providers and a Service Broker.

The first aspect is achieved by using a Web Service development tool that converts an IDL interface to a WSDL document using the standard as specified by OMG's CORBA to WSDL/SOAP Inter-working specification (Version 1.1). Service Requestors or Web Services clients to make invocations can use the generated WSDL using SOAP over HTTP/HTTPS as transport.

To provide a Web services runtime, VisiBroker uses Apache Axis technology to handle the intricacies of a Services Broker. Using a proprietary type-specific bridge (generated by the tool), deployed stateless CORBA objects can be made accessible. The type-specific bridge instances act as the Service Providers bringing forward the functionality of the CORBA object back end to the Service Requestors.

## Web Services Artifacts

The figure below explains the Web Services development tool provided with VisiBroker that generates the WSDL document and the Bridge code from an IDL file. The WSDL document is useful for the Services Requesters and along with the service description; it also provides the SOAP binding information, which allows any SOAP compliant client to make invocation.

The generated bridge artifact is actually a language/type-specific service provider component that gets deployed in the Service Broker (Axis runtime) and an instance of this is responsible for adapting the incoming SOAP message from the Service Requester to a bound CORBA object.

**Figure 41** VisiBroker Web Services

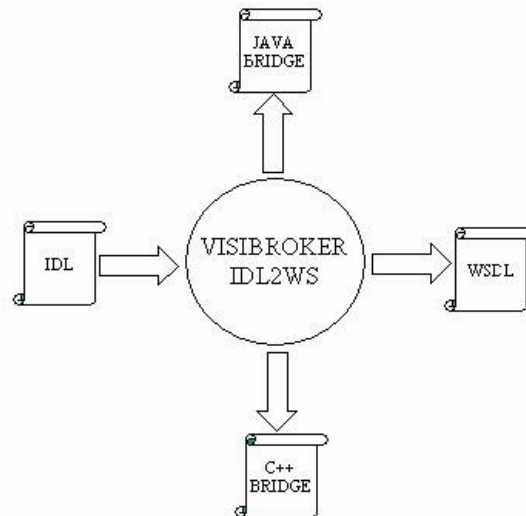

## Web Services Runtime

To explain the run-time behavior, the figure below shows a SOAP client making use of the generated WSDL to make SOAP/HTTP or SOAP/HTTPS invocations on three CORBA objects exposed as Web Services in VisiBroker for C++, Java and a pre 7.0 VisiBroker process.

VisiBroker for Java process comes with the infrastructure for HTTP/SOAP and HTTPS/SOAP listeners, which are by default turned off. By setting the command line property `vbroker.ws.enable=true`, HTTP/SOAP runtime infrastructure can be started. With web services enabled, HTTPS/SOAP infrastructure in VisiBroker for Java can be activated using the property `vbroker.security.disable=false`. Once the infrastructure is started, the Service providers (bridge) for the CORBA objects can be deployed using Axis's WSDD mechanism. Using few VisiBroker proprietary CORBA object binding related WSDD elements, the deployed bridge instances can be bound to CORBA objects and any SOAP invocations on the bridge is adapted to an in-process CORBA invocation. The bridge in reality is a morph of the Axis's server side generated code, with each web service implementation skeleton mapped to a method on a type specific CORBA object stub. Because the bridge is generated directly from IDL, all the type-safety and fidelity of IDL types is inherently built in. Also, because the bridge is loaded in the same process as the COBA objects, all invocation on the CORBA object from the bridge is optimized because of VisiBroker's "inprocess" bidder.

In the figure the cloud "Ax" depicts the Axis + HTTP listener component loaded into the VisiBroker process. "Ob" cloud depicts a CORBA object inside the ORB. The association between the "Ax" and "Ob" cloud as shown by the two small circles between them indicates the deployment of a bridge on the Axis runtime exposing the CORBA object to Service Requesters. Existing CORBA clients can continue making GIOP over IIOP invocations through the GIOP/IIOP listener as usual without any impact.

**Figure 42** Web Services run-time behavior

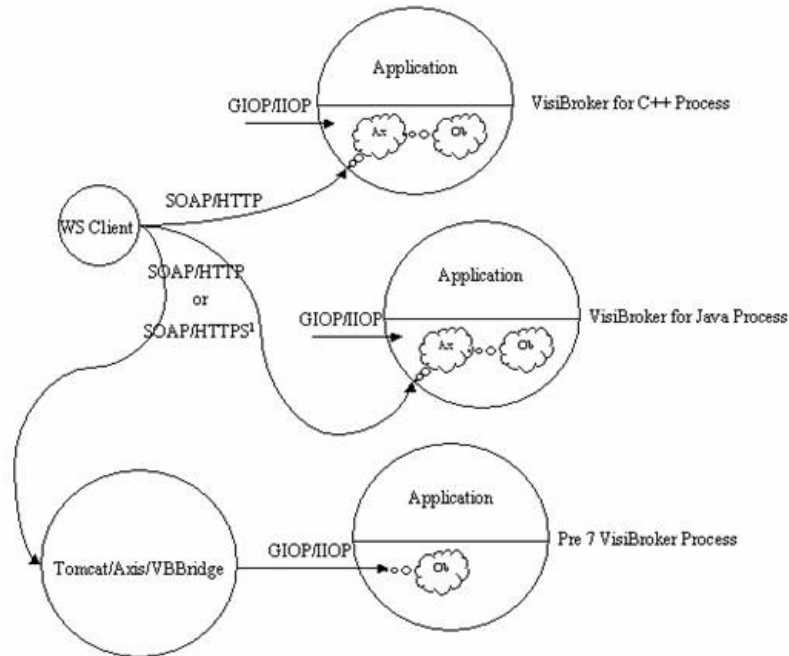

<sup>1</sup> SOAP over HTTPS is only supported for VisiBroker for Java

To support exposing CORBA objects in Pre 7.0 VisiBroker deployments, the bridge can be deployed on an Axis instance running externally to the VisiBroker process. The only difference in this case is that that SOAP to GIOP adaptation will be remote and hence will be over the wire. In the above figure, this is shown by deploying the bridge on Axis for Java embedded in Apache Tomcat. The cloud "Ob" indicates the CORBA object instance running on a remote Pre 7 VisiBroker Process and the request from the bridge comes in through the GIOP/IIOP end point.

The figure below explains the components inside a VisiBroker process. The "Axis runtime" cloud contains the Axis runtime, the HTTP listener along with the SOAP request dispatcher. A CORBA object inside the process is exposed as a Web Service by deploying its Service provider or the bridge as a Web Service using the Axis WSDD mechanism. When a SOAP client makes an invocation on the Web Service, the HTTP listener picks up the SOAP request and the request is passed to the dispatcher. The dispatcher invokes on the Axis runtime passing in the SOAP request. The Axis runtime decodes the SOAP request and makes invocation on an instance of the deployed Service provider (bridge). The bridge then makes use of the binding information provided in the WSDD to bind to the actual CORBA object and make the CORBA invocation.

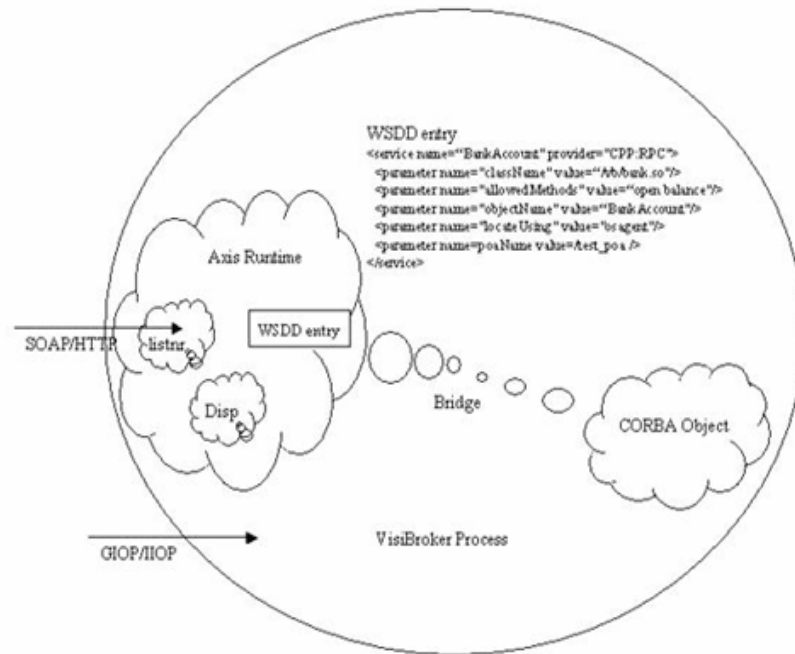

**Figure 43** Components inside a VisiBroker process

In the above context, the Service Broker includes only a SOAP node on a HTTP transport. Other services needed for a Web Services deployment such as a UDDI service etc are not provided. Various implementations of these are available and can easily be used.

## Exposing a CORBA object as Web Service

To expose a CORBA object as a Web Service in VisiBroker for Java, the following steps need to be performed:

- 1 Development
  - a Generate the server-side servant skeletons
  - b Generate the interface type-specific Java bridge from the IDL file
  - c Generate WSDL document for the IDL interface from the IDL file
- 2 Deployment
  - a Enable/Configure Web Service Runtime
  - b Deploy the bridge classes in the VisiBroker process using Axis WSD mechanism.

This section illustrates an example provided in the "vbroker/ws/bank" sub directory of examples directory (SOAP over HTTPS example for VisiBroker for Java server processes can be found under the directory "security/ws/animal"). This example is an adaptation of the "vbroker/basic/bank\_agent" example and consists of two interfaces Account and AccountManager. The AccountManager allows for creation of new named accounts. If an account for a particular name already exists, the account is retrieved without creating a new account. Account interface allows for querying of balance in the account. The Server sets up a POA under the root POA and activates an object implementing the AccountManager interface. On making the open operation on this object, separate objects implementing Account interface

are created, stored and returned. The code sample shown below illustrates the two interfaces.

```
// Bank.idl
module Bank {
    interface Account {
        float balance();
    };
    interface AccountManager {
        Account open(in string name);
    };
};
```

In this example, it will be shown how this stateful application can be enhanced to support SOA using Web Services. As a first step in the development, the stateful operations need to be converted to a coarser grained abstraction suitable for SOA. The interface shown below is one such example. This interface as shown, supports a single operation that opens a named account if the account does not already exist and returns the balance in the account.

```
// BankWebService.idl
module BankWebService {
    interface AccountManagerWebService {
        // opens account if not already opened, and returns
        // balance
        float openAndQueryBalance(in string name);
    };
};
```

A CORBA object is then implemented which implements this interface, which internally uses the Account and AccountManager interfaces and activated on a known POA with a well known object ID.

Once the server has been enhanced to for stateless operations, web service support can be implemented as illustrated in the following sections.

## Development

### 1 Generating the server POA servant code

Using the idl2java compiler, generate the server side skeleton classes for the CORBA interfaces Account and AccountManager in Bank.idl, and AccountManagerWebService in BankWebService.idl.

```
prompt> idl2java Bank.idl
prompt> idl2java BankWebService.idl
```

### 2 Generating the Java interface type specific bridge

Using the idl2wsj compiler with `-gen_java_bridge` option, the Java bridge for all interfaces can be generated. The following command will generate bridge code for BankWebService.idl in a file named AccountManagerWebService.java. This code is opaque to the applications and should not be changed.

```
prompt> idl2wsj -gen_java_bridge BankWebService.idl
```

### 3 Generating WSDL from IDL

In addition to bridge code, idl2wsj in step 2 will also generate a WSDL document for the IDL file according to OMG's CORBA to WSDL/SOAP Inter-working specification (version 1.1). This WSDL document can then be published through external means to potential Web Service clients or

Client development teams. `idl2wsj` can also be used to generate only WSDL document as follows:

```
prompt> idl2wsj BankWebService.idl
```

The generated bridge code is then deployed as a Web Service.

For a complete list of the options available, see “[idl2wsj](#)”.

## Deployment

- 1 The first step is to deploy WSDO document in AXIS run-time. WSDO or Web Service Deployment Descriptor is a standard Axis means to instruct on deployment related information. A WSDO (`deploy.wsdd`) for the bridge is created during the bridge creation. A sample WSDO is shown below which aims to deploy a Web Service hosted in a CORBA object with object id “`BankManagerWebService`”.

```
<?xml version="1.0" encoding="UTF-8"?>
<deployment xmlns="http://xml.apache.org/axis/wsdd/"
            xmlns:java="http://xml.apache.org/axis/wsdd/providers/java">
  <service
    name="BankWebService.AccountManagerWebServicePort"
    provider="java:VISIBROKERPROVIDER">
    <namespace>
      http://BankWebService.AccountManagerWebService
    </namespace>
    <parameter
      name="className"
      value="[package].BankWebService_AccountManagerWebService "/>
      <operation name="openAndQueryBalance">
        <parameter qname="name" type="tns:string"
          xmlns:tns="http://www.w3.org/2001/XMLSchema/" />
        </operation>
    </service>
</deployment>
```

- 2 Create a property file `server.prop` to set up the Web Service runtime. Following is a sample property file. The following properties configure the Service Broker to start up a HTTP server on host `143.186.141.54` at port `19000`. The connection manager is set up to allow maximum of `30` concurrent connections with `300` seconds to mark the connection idle time. The thread pool to service the incoming SOAP request is setup to have maximum of `300` threads with thread idle time set to `300` seconds. For a complete list of configurable properties, refer the “Web Service Runtime Properties” section of “VisiBroker properties” chapter.

```
vbroker.ws.enable=true
vbroker.se.ws.host=143.186.141.54
vbroker.se.ws.scm.ws_ts.listener.port=19000
vbroker.se.ws.scm.ws_ts.manager.connectionMax=30
vbroker.se.ws.scm.ws_ts.manager.connectionMaxIdle=300
vbroker.se.ws.scm.ws_ts.dispatcher.threadMin=0
vbroker.se.ws.scm.ws_ts.dispatcher.threadMax=300
vbroker.se.ws.scm.ws_ts.dispatcher.threadMaxIdle=300
```

- 3 Run the Server as follows:

```
prompt> vbj -DORBpropStorage=server.prop Server
```

- 4 The generated bridge code can be deployed with `deploy.wsdd` (generated with bridge) in AXIS runtime using AXIS utility `AdminClient` as follows:

## SOAP/WSDL compatibility

```
prompt> java org.apache.axis.client.AdminClient  
-lhttp:// 143.186.141.54:19000/axis/ deploy.wsdd
```

## **SOAP/WSDL compatibility**

SOAP version 1.1 and WSDL version 1.1 is supported.

# Index

## Symbols

- `_get_policy` 155
- `_is_a()` method 153
- `_is_bound()` method 154
- `_is_local()` method 154
- `_is_remote()` method 154
- `_set_policy_override` method 155
- `_tie` class 147
  - delegator implementation 147
  - examples 147
- ... ellipsis 1
- `*_interface_name()` method 153
- `*_repository_id()` method 153
- `*object_to_string()` method 153
- symbols
  - square brackets 1
- `#pragma` mechanisms 298
- | vertical bar 1

## A

- abstract interfaces 53, 429
- abstract valuetypes 426
- `account.idl`
  - files produced from `account_c.cc` 15
  - files produced from `account_c.hh` 15
  - files produced from `account_s.cc` 15
  - files produced from `account_s.hh` 15
- AccountManager interface, DSI 338
- `activate()` method 445
- activating objects 303
  - arguments passed by OAD 306
  - deferring 445
  - deferring with service activators 446
- activation 7
  - service activation 446
- Activator class
  - deactivating an ORB object 445
  - deferring object activation 445, 447
- ActiveObjectLifeCycleInterceptor 369
  - class 368
- adapter
  - Naming Service 214
  - VisiNaming Service 214
- adapters, DII 319
- adding fields to user exceptions 97
- administration commands
  - `oadutil list` 298
  - `oadutil unreg` 306
  - `osfind` 185
- Agent interface 188
- agent, reporting 185
- `agentaddr` file, specifying IP addresses 183
- Any
  - Any type DSI 338
  - Any type mapping 58
  - class 327
  - object 320
- application development costs, reducing 5
- applications

- defining object interfaces 14
- deploying 20
- enabling bidirectional IIOP 439
- locating osagent via `vbj` command 33
- running 19
- starting client program 20
- starting server object 19
- starting Smart Agent 19
- thread pool 134
- thread-per-session 136
- arguments, `-ORBshmsize` 33
- arrays, mapping 46
- asynchronous communication 437
- authentication
  - bidirectional IIOP 441
  - Naming Service client 228
  - VisiNaming client 228
- authorization
  - method level for the Naming Service 230
  - method level for VisiNaming 230
  - Naming Service method level 228
  - VisiNaming method level 228

## B

- backing store 212
  - improving performance 217
- `backingStoreType` 77
- backward compatibility, Event Service 241
- BAD\_CONTEXT exception 451
- BAD\_INV\_ORDER exception 451
- BAD\_OPERATION exception 451
- BAD\_PARAM exception 451
- BAD\_TYPECODE exception 451
- basic types, IDL types 38
- bidirectional IIOP 437
  - enabling for existing applications 439
  - examples 438, 440
  - InvalidPolicy exception 441
  - POAs 440
  - security 441
  - unidirectional connections 440
- BiDirectional policy 441
- bidirectional properties 437
- bidirectional SCM 437, 441
- bind
  - generic object references 322
  - `nsutil` 205
  - process 151
- bind process
  - actions performed by `_bind()` 151
  - binding to objects 151
  - connection to objects established 151
  - proxy object created 151
- `bind_context`, `nsutil` 205
- `bind_new_context`, `nsutil` 205
- `bind()`, osagent 177
- binding, ORB's tasks 186
- BindInterceptor, class 368
- BOA

- backward support 445
- binding 186
- class moved 443
- compiling code 443
- limitations in using 443
- naming objects 444
- object activators 443, 445
- options 443
- supported options 443
- using with VisiBroker 443
- BOA\_init, change to package 443
- boolean type, mapping 43
- bound objects, determining location and state 154
- boxed valuetypes 429
- brackets 1
- bridges, DII 319
- broadcast address 181
- broadcast messages 175

## C

- caching facility 217
- Caffeine compiler, description 30
- catching exceptions
  - modifying object to 97
  - system exceptions 95
  - user exceptions 97
- ChainUntypedObjectWrapper 389
- char type, mapping 43
- class
  - ActiveObjectLifecycleInterceptor 368
  - Any 327
  - BindInterceptor 368
  - ClientRequestInterceptor 343, 368
  - Codec 347
  - CodecFactory 347
  - CreationImplDef 303
  - DefaultBindInterceptor 371
  - DefaultClientInterceptor 371
  - DefaultServerInterceptor 371
  - DynamicImplementation 334
  - Interceptor 342
  - IORCreationInterceptor 368
  - IORInterceptor 346
  - NamedValue 326
  - Naming Context 208
  - NVList 338
  - NVList ARG\_IN parameter 338
  - NVList ARG\_INOUT parameter 338
  - NVList ARG\_OUT parameter 338
  - ORBInitializer 348
  - ORBInitInfo 348
  - ORInfoExt 350
  - POALifecycleInterceptor 368
  - PullConsume 250
  - PullConsumerPOA 250
  - PullSupplierPOA 247
  - Repository 317
  - Request 323
  - ServerRequest 337
  - ServerRequestInterceptor 368

- TypeCode 327
- classes
  - \_tie 147
  - default Interceptor 371
  - PICurrent 346
- CLASSPATH 33
- classpath 35
- client
  - authentication Naming Service 228
  - bidirectional connection to server 440
  - bidirectional IIOP 437
  - implementing 16
  - initializing the ORB 151
  - Interceptors 367
  - locating osagent via vbj command 33
  - receiving asynchronous information 437
  - referencing a Server Manager 257
  - runtime 163
  - unidirectional connection to server 440
  - using the DII 322
  - using thread pool 134
  - using thread-per-session 136
- client and server, running 19, 21
- client request interceptors, examples 355
- client stubs, generating 15
- ClientRequestInterceptor 368
  - class 343, 368
  - implementing 354
- clients, building with Dynamic Invocation Interface 319
- Cluster Manager interface 221
- cluster, creating in a Naming Server 221
- ClusterManager 218
- clusters 218
- code
  - building 19
  - building with nmake 19
  - building with vbmake 19
  - compiling BOA 443
  - generation 15
- code set support 162
  - classification 162
  - conversion code set 163
  - native code set 163
  - negotiation 163
  - transmission code set 163
  - types 162
- Codec 347
  - class 347
  - interface 347
- CodecFactory 347
  - class 347
  - interface 347
- COMM\_FAILURE exception 451
- commands
  - conventions 1
  - idl2ir 26, 27
  - idl2java 27
  - java2idl 29
  - java2iiop 30
  - vbj 33

- Common Object Request Broker. *See*
  - CORBA
- compilers
  - IDL, feature summary 7
  - java2idl 409
  - java2iop 409
  - nmake 19
  - vbmake 19
- compiling BOA code 443
- completion status 94
  - obtaining for system exceptions 94
- complex name 202
- connecting
  - client applications with objects 5
  - point-to-point communications 182
  - Smart Agents on different local networks 179
- connection management 7, 136
  - properties 141
- connections
  - garbage collection 144
  - managing, feature summary 7
- ConnEventListener interface 405
- connID 405
- ConnInfo 405
  - connID 405
  - ipaddress 405
  - port 405
- constants, mapping 45
- constructed types mapping 46
- Container class 259
- container, Server Manager 258
- conversion code set 163
- CORBA
  - Common Object Request Broker
    - Architecture 5
    - defined 5
    - definition 147
    - description of 5
    - exceptions 451
    - VisiBroker compliance 9
- corbaloc URL 206
- corbaname URL 206
- CosNaming operations, supported by
  - VisiNaming 205
- CosNaming, calling from the command line 204
- creating software components 5
- CreationImplDef class 303
  - activation\_policy property 303
  - args property 303
  - env property 303
  - path\_name property 303
- CreationImplDef struct, activating an object 304
- Current interface 346
- custom valuetypes 430

**D**

- D\_VIS\_INCLUDE\_IR flag 317
- DATA\_CONVERSION exception 451

- DataExpress adapter 212
- deactivate() method 445
- default factories 429
- DefaultBindInterceptor class 371
- DefaultClientInterceptor class 371
- DefaultServerInterceptor class 371
- deferring object activation 446
  - service activation 447
- delegation, with server
  - implementations 56
- deployment, description 20
- destroy, nsutil 205
- development, defining object
  - interfaces 14
- DII 8
  - Any objects 320
  - asynchronous requests 330
  - building clients 319
  - client 322
  - concepts 320
  - creating a DII request 324
  - creating a request 323
  - disadvantages 319
  - examples 322
  - feature summary 8
  - generating portable stubs 30
  - generic object reference 322
  - initializing a request 323
  - Interface Repository 311, 331
  - NamedValue class 326
  - NamedValue interface 326
  - NVList objects 321
  - overview 319
  - receiving multiple requests 330
  - receiving replies 322
  - receiving results 329
  - Reply receiving options 320
  - Request interface 323
  - Request objects 320
  - Request sending options 320
  - send\_deferred method 329
  - send\_oneway method 330
  - sending a request 329
  - sending multiple requests 330
  - sending requests 321
  - setting request arguments 326
  - Typecode objects 320
  - using idl2java compiler 322
  - using request objects 320
  - using the \_request method 324
  - using the create\_request method 324
- disabling Smart Agent 176
- dispatch policies and properties 139
- dispatch policy
  - thread pool 139
  - thread-per-session 141
- Dispatcher properties 126
- distributed applications, development
  - process for 13
- documentation
  - .pdf format 3
  - accessing Help Topics 1

- platform conventions used in 2
- type conventions used in 1
- updates on the web 3
- domains, running multiple 178
- DSI
  - AccountManager interface 338
  - activating objects 339
  - Any type 338
  - BAD\_OPERATION exception 338
  - compiling object servers 334
  - creating object implementations
    - dynamically 334
  - deriving classes 334
  - deriving from DynamicImplementation
    - class 334
  - examples 334
  - feature summary 8
  - implementing server object 337
  - input parameters 338
  - inter-protocol bridging 333
  - object dynamic creation 334
  - overview 333
  - processing input in DSI 338
  - protocol bridging 333
  - return values 338
  - scope resolution operator 336
  - ServerRequest class 337
  - using idl2java compiler 333
- Dynamic Invocation Interface. *See* DII
- Dynamic Skeleton Interface. *See* DSI
- DynamicImplementation class 334
  - example of deriving from 334
- DynAny
  - access and initializing 416
  - creating 416
  - initializing and accessing the value 416
  - overview 415
  - types 415
- DynAny interface 415
  - constructed data types 416
  - current\_component method 416
  - DynAnyFactory object 416
  - DynArray data type 417
  - DynEnum interface 417
  - DynSequence data type 417
  - DynStruct interface 417, 418
  - DynUnion interface 417
  - example application 418
  - example client application 418
  - example IDL 418
  - example server application 420
  - examples 415
  - NameValuePair 418
  - next method 416
  - restrictions 416
  - rewind method 416
  - seek method 416
  - to\_any method 418
- DynArray data type 417
- DynEnum interface 417
- DynSequence data type 417
- DynStruct interface 417

- DynUnion interface 417

## E

- effective policies 155
- enableBiDir property 437
- enums mapping 46
- environment variables
  - for OAD 296
  - OSAGENT\_ADDR 182
  - OSAGENT\_LOCAL\_FILE 181
- event channel 245
  - in-process implementation 253
- event listeners 405
  - ConnInfo 405
- Event queue 405
  - code samples 407
  - connection EventListener 407
  - connection events 405
  - ConnEventListener interface 405
  - event listeners 405
  - event types 405
  - EventListener interface 405
  - EventQueueManager interface 405
  - overview 405
  - registering EventListeners 407
- Event Service
  - communication models 243
  - examples 247
  - in-process event channel 254
  - overview 241
  - pull model 244
  - push model 243
  - setting queue length 253
  - starting 252
  - event types 405
    - connection types 405
- EventChannel 243
- EventLibrary 253, 254
- EventListener 405
  - implementing a connection 407
  - registering 407
- EventQueueManager interface 405
- example
  - DynAny IDL 418
  - oadutil unreg utility 307
- example application
  - building the example 19
  - compiling 19
  - defining object interfaces 14
  - deploying the application 20
  - development process 13
  - generating client stubs 15
  - implementing the client 16
  - implementing the server 18
  - running the example 19
  - server servants 15
  - starting the server 19
  - with VisiBroker 13
  - writing account interface in IDL 14
- examples
  - \_tie class 147



- activating objects 445, 447
- activation 447
- bidirectional IIOP 438
- deferred method in object
  - activation 447
- DSI 334
- Interceptors 373
- Interface Repository 317
- IR 317
- Naming Service 232
- object wrappers 386
- odb 447
- Portable Interceptors 352
- push consumer 247
- push supplier 247
- request interceptors 355
- RMI-IIOP 410, 411
- Server Manager 265
- Smart Agent localaddr file 181
- URL Naming Service 433
- using the DII 322
- VisiBroker Interceptors 373
- VisiNaming Service 232

exceptions

- adding fields to user exceptions 97
- catching user exceptions 97
- completion status for exceptions 94
- CORBA 451
- CORBA overview 93
- CORBA-defined system exceptions 93
- handling 94
- heuristic 456
- InvalidPolicy 441
- Java IDL system 58
- mapping 57
- narrowing to system exceptions 95
- system 58
  - SystemException class 93
- throwing 96
- user-defined 57

exportBiDir property 437

## F

- Factories 426
  - default 429
  - implementing 428
  - valuetypes 428
- Factory class 427
- factory\_name 205
- failover
  - Naming Service 224
  - VisiNaming Service 224
- fault tolerance 6
  - Naming Service 225
  - replicating objects registered with OAD 184
  - VisiNaming Service 225
- features of VisiBroker 6
  - activating objects and implementations 7
  - compilers, IDL 7

- connection management 7
- dynamic invocation 8
- IDL compilers 7
- IDL interface to Smart Agent 7
- implementation activation 7
- implementation repository 8
- interface repository 8
- Location Service 7
- multithreading 7
- object activation 7
- object database integration 9
- Smart Agent architecture 6
- thread management 7

file extensions 15

files

- impl\_rep 295
- localaddr 181
- produced by compiling 15
- produced by idl compiler 15

floating point, mapping 43

FREE\_MEM exception 451

## G

- garbage collection 144
- Generic object testers, DII 319
- get\_listeners 405
- globally scoped objects, Smart Agent
  - registration 173

## H

- handling system exceptions 94
- Help Topics
  - accessing 1
- Helper classes, mapping 44
- heuristic exceptions 456
- Holder classes, mapping 39

## I

- id field, NameComponent 201
- IDL
  - compilers 15
  - constructs represented in Interface Repository 311
  - creating from Java 29
  - defining one-way methods 170
  - DynAny example 418
  - example specification 165
  - generating Java code 27
  - information contained in IR 311
  - interface inheritance 171
  - mapping constants 45
  - mapping constructed types 46
  - mapping interfaces 52, 55
  - mapping modules 38
  - mapping names to Java 37
  - mapping nested types 58
  - mapping parameters 54
  - mapping to Java 14, 37
  - mapping typedefs 59
  - mapping types 38
  - OAD interface 308

- reserved names 37
- reserved words 38
- Server Manager 258
- specifying objects 14
- type extensions 39
- using Java to define IDL 30
- IDL file, #pragma mechanisms 298
- IDL type
  - basic types 38
  - boolean 43
  - char 43
  - complex 59
  - floating point type 43
  - Holder classes 39
  - integer type 43
  - octet 43
  - simple 59
  - string 43
  - wstring 43
- idl2cpp compiler 15
  - attribute methods 170
  - defining one-way methods 170
  - generating code 165
  - interface inheritance 171
- idl2ir 26
  - command info 26, 27
  - description 26, 27
  - options 26
- idl2ir compiler 314
  - command info 10
  - description 10
- idl2java
  - command info 27
  - generating portable stubs for DII 27
  - options 27
- idl2java compiler
  - generating stub code using DII 322
  - generating stub code using DSI 333
  - portable flag 322, 333
- IIOP
  - bidirectional examples 438, 440
  - enabling bidirectional 439
  - using bidirectional 437
- IMP\_LIMIT exception 451
- impl\_rep file 295
- implementation
  - activation 7
  - connections with Smart Agents 173
  - fault tolerance 183
  - stateless, invoking methods on 183
  - support 7
  - unregistering with the OAD 306
- Implementation Repository 8
  - feature summary 8
  - for OAD 298
  - impl\_rep file 295
  - listing contents 308
  - removed when unregistered with the OAD 306
  - specifying directory with OAD 296
  - stored registration information 295
  - unregistering objects 306
- using OAD 296
- implementations
  - binding 186
  - reporting 185
  - unregistering with OAD 306, 307
  - using delegation 56
  - using thread-per-session 136
- implementing
  - the server 18
  - valuetypes 426
- import statements
  - Naming service 231
  - VisiNaming Service 231
- importBiDir 441
- importBiDir property 437
- inheritance
  - allowing from implementations 147
  - implementing servers 55
  - interface 171
- inheritance of interfaces, specifying 171
- INITIALIZE exception 451
- In-memory adapter 212
- in-process event channel 253, 254
- input parameters, processing in DSI 338
- input/output arguments for method
  - invocation requests 326
- instances
  - determining for object reference 153
  - finding with Location Service 187
- integer mapping 43
- interception points
  - order of invocation 382
  - request interception points 342, 344
  - ServerRequestInterceptor 344
- Interceptor
  - class 342
  - default Interceptor classes 371
  - interface 342
- Interceptor interface
  - example 373
  - registering with the ORB 371
- Interceptor objects, creating 372
- Interceptors
  - ActiveObjectLifeCycleInterceptor 369
  - and client side Portable Interceptors 382
  - and server side Portable Interceptors 383
  - API classes 368
  - BindInterceptor 368
  - client 368
  - client Interceptors 367
  - ClientRequestInterceptor 368
  - creating Interceptor objects 372
  - example program 373
  - interfaces 368
  - IORCreationInterceptor 370
  - loading 372
  - managers 368
  - overview 367
  - passing data between 382
  - POALifeCycleInterceptor 369

- registering Interceptors with the ORB 371
  - server 369
  - server Interceptors 367
  - ServerRequestInterceptor 370
  - ServiceResolverInterceptor 371
  - using 367
  - using with Portable Interceptors 382
- interceptors
  - customizing the ORB 8
  - IOR 341
- interface
  - attributes 170
  - Codec 347
  - CodecFactory 347
  - Current 346
  - defining in IDL 14
  - inheritance 171
  - Interceptor 342
  - IORInterceptor 346
  - looking up 317
  - ORBInitializer 348
  - ORBInitInfo 348
  - ORInfoExt 350
- Interface Definition Language. *See* IDL
- interface name
  - converting to repository ID 297
  - defining 165
  - obtaining 153
  - unregistering objects with OAD 306
- Interface Repository 8
  - \_get\_interface() method 312
  - accessing object information 317
  - contents 315
  - contents of 311
  - creating 313
  - description 311
  - examples 317
  - feature summary 8
  - identifying objects within 315
  - inherited interfaces 316
  - populating with idl2ir 10, 26, 27
  - properties 81
  - structure 314
  - types of objects stored in 315
  - updating contents with idl2ir 314
  - viewing contents of 313
- interface scope mapping 57
- InterfaceDef object, in Interface Repository 311
- interfaces
  - ConnEventListeners 405
  - descriptions of in Interface Repository 311
  - EventListener 405
  - EventQueueManager 405
  - mapping 52, 55
  - NamingContextExt 208
  - Quality of Service 155
  - reporting 185
  - specifying inheritance 171
  - using java2iiop 413
- INTERNAL exception 451
- interoperability 11
  - ORB interoperability 11
  - with other ORB products 11
  - with VisiBroker for C++ 11
  - with VisiBroker for Java 11
- INTF\_REPOS exception 451
- INV\_FLAG exception 451
- INV\_INDENT exception 451
- INV\_OBJREF exception 451
- INVALID\_TRANSACTION exception 451
- InvalidPolicy exception 441
- InvalidURL exception 435
- invocation feature summary 8
- invoke() method 333, 334
  - example of implementing 334
- IOR interceptors 341
- IORCreationInterceptor 370
  - class 368
- IORInfoExt class 350
- IORInterceptor
  - class 346
  - interface 346
- IP subnet mask
  - broadcast messages specifying scope of 179
  - localaddr file 181
- ipaddress 405
- IR
  - accessing object information 317
  - contents 315
  - description 311
  - examples 317
  - identifying objects within 315
  - inherited interfaces 316
  - structure 314
  - types of objects stored in 315
  - See also* Interface Repository
- ir2idl 27
  - options 27
- ir2idl utility, viewing contents of IR 313
- irep tool
  - creating an Interface Repository 313
  - creating Interface Repository 312
  - viewing Interface Repository 313

## J

- Java
  - creating an IDL file from Java 29
  - defining IDL interfaces 30
  - generating code from IDL file 27
  - Java Development Kit (JDK) 10
  - mapping from IDL 37
  - null 42
  - RMI over IIOP properties 61
  - runtime environment 11
  - starting the interpreter via vbj 33
- Java applets, setting up with RMI-IIOP 409
- java2idl 409
  - command info 29

- description 29
- options 29
- java2iiop 409
  - command info 30
  - generating portable stubs for DII 30
  - mapping complex data types 413
  - mapping primitive types 413
  - options 30
- JDBC adapter 212
- JDBC Adapter properties 77
- jdbcDriver 77
- JVM 35

## K

- kind field, NameComponent 201

## L

- list, nsutil 205
- Listener properties 125
- listener threads 132
- load balancing
  - migrating objects between hosts 184
  - Naming Service 223
  - using Location Service 187
  - VisiNaming Service 223
- Local interfaces 54
- localaddr file, specifying interface
  - usage 181
- Location Service 187
  - Agent interface 188
  - components of agent 188
  - enhanced object discovery 7
  - feature summary 7
  - properties 74
  - trigger 190
  - triggers 188
- location service, Smart Agent 175
- location, determining for an object
  - reference 154
- loginPwd 77

## M

- makefile sample for Solaris 19
- mapping 44
  - abstract interfaces 53
  - Any type 58
  - arrays 46
  - boolean type 43
  - char type 43
  - constants 45
  - constructed types 46
  - enums 46
  - exceptions 57
  - floating point 43
  - Holder classes 39
  - IDL names 37
  - IDL type 38
  - integer 43
  - interface scope 57
  - interfaces 52
  - local interfaces 54

- modules 38
- nested types 58
- octet 43
- passing parameters 54
- reserved names 37
- reserved words 38
- sequences 46
- string 43
- structs 46
- typedefs 59
- unions 46
- MARSHAL exception 451
- marshalling, using java2iiop 413
- maxQueueLength 253
- messages
  - broadcast 175
  - broadcasting via vbj command 33
- method 155
- method level authorization, Naming Service 228
- methods
  - \_get\_policy 155
  - \_is\_a() 153
  - \_is\_bound() 154
  - \_is\_local() 154
  - \_is\_remote() 154
  - \_set\_policy\_override method 155
  - \*\_interface\_name() 153
  - \*\_object\_name() 153
  - \*\_repository\_id() 153
  - \*object\_to\_string() 153
  - activate() 445
  - boa.obj\_is\_ready() 334
  - deactivate() 445
  - defining one-way 170
  - example of implementing invoke() 334
  - invoke() 333, 334
  - objects maintaining state 184
  - ORB\_init(), ORBshmsize 33
  - stateless objects, invoking on 183
  - string\_to\_object() 153
- migrating
  - instantiated objects 185
  - objects 184
  - objects between hosts 184
  - objects registered with OAD 185
  - objects with state 184
- modifying object to throwing
  - exceptions 96
- ModuleDef object in Interface Repository 311
- modules, mapping 38
- multihomed hosts 180
  - specifying interface usage 181
- multithreading 131
  - feature summary 7

## N

- name
  - complex 202
  - defined 201

- resolution 201, 202
  - simple 202
  - stringified 202
- Name, binding names to objects 199
- NameComponent
  - defined 201
  - id field 201
  - kind field 201
- NamedValue
  - class 326
  - objects 326
  - pair 326
- namespace 199
- Naming Context class 208
- naming contexts, default 209
- Naming Service
  - adapters 214
  - bootstrapping 206, 230
  - caching facility 217
  - client authentication 228
  - clusters 218
  - configuring 203
  - configuring to use SSL 229
  - CosNaming operations supported 205
  - creating a cluster 221
  - default naming context 209
  - enabling security (C++) 229
  - enabling security (Java) 229
  - examples 232
  - failover 224
  - fault tolerance 225
  - import statements 231
  - initializing in Java 209
  - installing 203
  - load balancing 223
  - method level authorization 228, 230
  - OMG compliant features 231
  - pluggable backing store 212
  - properties 209
  - properties file 214
  - properties for SSL (C++) 229
  - properties for SSL (Java) 229
  - sample programs 232
  - security 228
  - shutting down 205
  - starting 203
  - URL 433
  - using SSL 229
  - VisiBroker ORB extensions 231
- naming service properties 75
- NamingContext
  - bootstrapping 201
  - factories 201
- NamingContextExt 208
- NamingContexts
  - defined 200
  - use by client applications 200
  - use by object implementations 200
- narrowing exceptions to system
  - exception 95
- native code set 163
- Native Messaging 269
- nested types, mapping 58
- network, reporting objects and
  - services 185
- new\_context, nsutil 205
- nmake compiler 19
- nmake, compiling with 19
- NO\_IMPLEMENT exception 451
- NO\_MEMORY exception 451
- NO\_PERMISSION exception 451
- NO\_RESOURCES exception 451
- NO\_RESPONSE exception 451
- nsutil 204
  - bind 205
  - bind\_context 205
  - bind\_new\_context 205
  - destroy 205
  - list 205
  - new\_context 205
  - rebind 205
  - rebind\_context 205
  - resolve 205
  - shutdown 205
  - unbind 205
- null
  - Java 42
  - semantics 429
  - valuetypes 426
- NVList class 338
  - ARG\_IN parameter 338
  - ARG\_INOUT parameter 338
  - ARG\_OUT parameter 338
  - implementing a list of arguments 326
- NVList object 321

## O

### OAD

- and osagent 176
- and Smart Agent 176
- and the Smart Agent 296
- arguments passed by 306
- IDL interface to 308
- impl\_rep file 295
- Implementation Repository 295
- interface names 297
- listing objects 298
- migrating objects registered with 185
- oadutil list 298
- overview 296
- programming interface 308
- properties 80
- registering objects 299, 304
- registration information 295
- replicating objects registered with 184
- repository IDs 297
- setting the activation policy 304
- specifying time-out 296
- starting 296
- storing registration info 298
- unregistering objects 306

OAD command, setting environment variables 296

- oadj, reporting 185
- oadutil
  - listing objects registered with OAD 298
  - unregistering implementations 306
- oadutil list 298
- oadutil tool
  - displaying contents of Implementation Repository 308
  - registering object implementations 295
- OBJ\_ADAPTOR exception 451
- object
  - accessing information from Interface Repository 317
  - activating 447
  - changing characteristics
    - dynamically 303
  - connecting to with OAD 176
  - connections with Smart Agents 173
  - dynamic creation with DSI 334
  - finding with Location Service 187
  - listing 298
  - multiple instances 303
  - registering 304
  - replicating 184
  - reporting objects on a network 185
  - setting the activation policy 304
  - specifying in IDL 14
  - state invoking methods on 184
  - stateless, invoking methods on 183
  - unregistering with the OAD 306
  - using CreationImplDef struct 304
- object activation 7
  - deferring 445
  - example of deferred method 447
  - service activation 446
  - support 7
- Object Activation Daemon. *See* OAD
- object activators 445
- Object Database Activator, feature
  - summary 9
- object discovery, enhanced with the Location Service 7
- object implementation
  - changing dynamically 303
  - fault tolerance 183
  - implementations that maintain state 184
- Object Management Group 5
- object migration 184
- object names
  - obtaining 153
  - qualifying binding with 151
- object reference
  - checking equivalent implementations 153
  - converting to string 153
  - converting to super-type 154
  - converting type 154
  - determining instance of type 153
  - determining location 154
  - determining state 154
  - determining type 153
- narrowing 154
- obtaining hash value 153
- obtaining interface name 153
- obtaining object name 153
- obtaining repository id 153
- operations on 152
- sub-type 153
- using the `_is_a()` method 153
- widening 154
- object references, persistent 444
- object registration, changing 303
- Object Request Broker. *See* ORB
- object wrappers
  - adding factories 390
  - adding typed wrappers 395
  - co-located client and server 394
  - customizing the ORB 8
  - deriving a typed wrapper 395
  - description 385
  - example programs 386
  - idl2java requirement 386
  - implementing untyped 388
  - installing untyped 389
  - overview 385
  - post\_method 387
  - pre\_method 387
  - removing typed wrappers 398
  - removing untyped factories 392
  - running sample applications 401
  - typed 385, 392
  - typed order of invocation 394
  - un-typed 385
  - untyped 386
  - untyped factory 388
  - using both typed and untyped wrappers 398
  - using multiple typed 393
  - using untyped 387
- OBJECT\_NOT\_EXIST exception 451
- object-oriented approach, software component creation 5
- objects
  - associating a URL 433
  - binding 186
  - executable's path 304
  - locating using URL 433
  - registering 303
- ObjectWrapper 395
- octet, mapping 43
- OMG 5
  - Common Object Services specification 242
  - Event Service 241
  - Notification Service 241
- OMG compliant features
  - Naming Service 231
  - VisiNaming Service 231
- one-way methods, defining 170
- online Help Topics
  - accessing 1
- open() method 338
- OpenLDAP 217

- OperationDef object in Interface Repository 311
- operator, scope resolution 336
- ORB
  - binding to objects 151
  - client runtime 163
  - connection to objects during bind process 151
  - creating proxy 186
  - customizing with interceptors and object wrappers 8
  - definition 186
  - domains 178
  - function of 5
  - initializing 99, 151
  - interoperability 11
  - object implementations 298
  - properties 65
  - resolve\_initial\_references 206
- ORB\_init() method, -ORBshmsize 33
- ORBDefaultInitRef property 207
- ORBInitializer
  - class 348
  - implementing 353
  - interface 348
  - registering 349
  - registration 353
- ORBInitInfo
  - class 348
  - interface 348
- ORBInitRef 204
- ORBInitRef property 206
- ORInfoExt interface 350
- osagent
  - bind() 177
  - binding 186
  - checking client existing (heartbeat) 177
  - detecting other agents 180
  - disabling 176, 177
  - ensuring availability 177
  - locating objects 175
  - object name 444
  - reporting 185
  - Smart Agent 173
  - starting 176
  - starting Smart Agents with 19
  - verbose output 176
- OSAgent (Smart Agent), VisiBroker architecture 6
- osagent log file, options 177
- OSAGENT\_ADDR 33
- OSAGENT\_ADDR environment variable 182
- OSAGENT\_LOCAL\_FILE environment variable 181
- OSAGENT\_PORT 33
- OSAgent, locating via vbj command 33
- osfind, command info 185
- overrides policy 155
- overview
  - VisiNaming Service 199

## P

- parameters, mapping 54
- PDF documentation 3
- PERSIST\_STORE exception 451
- persistent objects, ODA feature summary 9
- PICurrent class 346
- pluggable backing store
  - configuration 213
  - properties file 213
  - types 212
- POA
  - activating 110
  - activating objects 110, 114
  - activating with default servant 112
  - Active Object Map 106
  - adapter activator 106
  - adapter activators 128
  - and Server Engine 122
  - BiDirectional policy 441
  - creating 99, 106, 109
  - deactivating objects 113
  - definition 105
  - dispatcher properties 126
  - dispatching properties 122
  - enabling bidirectional IIOP 440
  - etherealize 106
  - incarnate 106
  - listener port property 126
  - listener properties 125
  - listening properties 122
  - managing POAs 120
  - ObjectID 106
  - POA manager 106, 120
  - policies 106
  - Policy 106
  - processing requests 128
  - properties 72
  - rootPOA 106, 109
  - servant 106
  - servant manager 106
  - servant managers 114
  - ServantLocators 118
  - Server Connection Managers 124
  - transient object 106
  - using servants 114
- POALifeCycleInterceptor 369
  - class 368
- point-to-point communication 182
- policies 155
  - effective 155
  - POA 106
- policy overrides 155
- poolSize 77
- port number, listener 126
- portability, server-side 8
- Portable Interceptors
  - creating 347
  - Current 346
  - examples 352
  - extensions 350

- interception points 344
- Interceptor 342
- IOR Interceptor 346
- IOR interceptors 341
- limitations 351
- overview 341
- PICurrent 346
- POA scoped server request 350
- registering 348
- request interception points 342
- request interceptor 342
- request interceptors 341
- ServerRequestInterceptor 344
- system exception 351
- types 341
- Portable Object Adapter. *See* POA
- process, bind 151
- programmer tools
  - idl2ir 26
  - ir2idl 27
- properties
  - DataExpress adapter 77
  - dispatcher 126
  - enableBiDir 437
  - Interface Repository 81
  - Java RMI over IIOP 61
  - JDBC adapter 77
  - JNDI adapter 77
  - listener 125
  - Location Service 74
  - Naming Service 209
  - naming service 75
  - OAD 80
  - ORB 65
  - ORBDefaultInitRef 207
  - ORBInitRef 206
  - POA 72
  - POA dispatching 122
  - POA listening 122
  - QoS 82
  - Server Manager 73
  - server-side server engine 83
  - server-side thread Pool BOA\_TP
    - connection 85
  - server-side thread pool IIOP\_TP
    - connection 84
  - server-side thread session BOA\_TS
    - connection 84
  - server-side thread session IIOP\_TS
    - connection 83
  - setting connection management 141
  - Smart Agent 62
  - SVCnameroot 206
  - thread management 143
  - URL Naming 82
  - vbroker.naming.cache 217
  - vbroker.naming.enableSlave 225
  - vbroker.naming.propBindOn 222
  - vbroker.naming.serverAddresses 225
  - vbroker.naming.serverClusterName 225
  - vbroker.naming.serverNames 225
  - vbroker.naming.slaveMode 225
  - vbroker.orb.dynamicLibs 372
  - vbroker.orb.enableBiDir 437
  - vbroker.orb.enableServerManager 263
  - vbroker.serverManager.enableOperations 263
  - vbroker.serverManager.enableSetProperty 263
  - vbroker.serverManager.name 257
  - VisiBroker BiDirectional 437
  - VisiNaming Service 75, 209
  - properties file, VisiNaming Service 214
  - proxy
    - consumer 242
    - supplier 242
  - proxy object, created during binding process 151
  - proxy objects, binding 186
  - ProxyPullConsumer 244
  - ProxyPullSupplier 244
  - ProxyPushConsumer 243
  - ProxyPushSupplier 243
  - pull
    - consumer 244
    - model 244
    - supplier 244
  - PullConsume 250
  - PullModel 247
  - PullSupplierPOA class 247
  - PullSupply 247, 249, 250
  - push
    - consumer 243
    - model 243
  - push supplier 243
    - example 247
    - implementin 247
  - PushConsumer, example 247
  - PushModel 247
    - class 247
  - PushSupplier
    - implementing 247
    - interface 247

## Q

  - Quality of Service (Qos) 155
    - interfaces 155
    - properties 82
  - queue length, setting 253

## R

  - rebind\_context, nsutil 205
  - rebind, nsutil 205
  - rebinds, enabling in Smart Agent 183
  - reducing application development costs 5
  - ref\_data parameter 303
  - reference data 303
  - register\_listener 405
  - registering objects using oadutil 299
  - registration
    - OAD Implementation Repository 295
    - Smart Agents 173



- Remote Method Invocation. *See* RMI
- Reply receiving options 320
- Repository class 317
- repository id, obtaining 153, 297
- Request class 323
- request interceptor 342
- request interceptors 341
  - examples 355, 360
  - interception points 342, 344
  - POA scoped server request 350
  - ServerRequestInterceptor 344
- Request object 320
- request objects, DII 320
- Request sending options 320
- RequestInterceptor, implementing 354
- REQUIRED\_AND\_TRUST 441
- reserved keywords 38
- reserved names, mapping 37
- reserved words, mapping 38
- resolve, nsutil 205
- Resolver interface, associating a URL with an object 434
- RMI 409
- RMI over IIOP 409
  - See also* RMI-IIOP
- RMI-IIOP 409
  - examples 410, 411
  - java applets 409
  - Java classes supported 413
  - java.policy file 409
  - java2idl 409
  - java2iiop 409
  - java2iiop interfaces 409
  - mapping IDL interfaces to Java classes 410
  - overview 409
  - running java2iiop 410
  - setting applet permissions 409
- root NamingContext 201
- rootPOA 109
- RoundRobin
  - Naming Service 223
  - VisiNaming Service 223
- running applications, starting client program 20
- runtime, client 163

## S

- sample programs
  - Naming Service 232
  - VisiNaming Service 232
- SCM, bidirectional IIOP 437
- scope resolution operator 336
- security
  - bidirectional IIOP 441
  - Naming Service 228
  - Naming Service client
    - authentication 228
  - Naming Service method level
    - authorization 228
  - VisiNaming Service 228

- VisiNaming Service client
  - authentication 228
- VisiNaming Service method level
  - authorization 228
- security (C++)
  - enabling in Naming Service 229
  - enabling in VisiNaming 229
- security (Java)
  - enabling in Naming Service 229
  - enabling in VisiNaming 229
- sequences, mapping 46
- server
  - and receiving client requests 99
  - bidirectional IIOP 437
  - implementing 18
  - initiating connections to clients 437
  - registering with the OAD 305
  - sending asynchronous info. to clients 437
  - Server Manager 257
  - setting the activation policy 304
  - setup 99
  - unidirectional connection to clients 440
  - waiting for client requests 103
- Server Connection Managers and POAs 124
- Server Engine and POAs 123
- server Interceptors 367
- Server Manager
  - accessibility 263
  - Container class 259
  - Container interface 259
  - container methods for Java 259
  - containers 258
  - custom containers 268
  - enabling 257
  - examples 265
  - getting started 257
  - IDL definition 263
  - obtaining a reference 257
  - overview 257
  - properties 73
  - Storage interface 258, 261
  - writing custom containers 268
- Server Manager IDL 258
- server request interceptors
  - examples 355, 360
  - POA scoped 350
- server servants, generating 15
- ServerRequest class 337
- ServerRequestInterceptor 370
  - class 368
  - implementing 354
  - interception points 344
- servers
  - callbacks without a GateKeeper 437
  - example of tie mechanism 148
  - threading considerations 141
  - using inheritance 55
- server-side
  - portability 8
  - server engine properties 83

- thread Pool BOA\_TP connection
  - properties 85
- thread pool IIOP\_TP connection
  - properties 84
- thread session BOA\_TS connection
  - properties 84
- thread session IIOP\_TS connection
  - properties 83
- service activation
  - deferring object activation 446
  - example 447
  - implementing deferred 447
- ServiceInit class 373
- ServiceLoader interface 372, 373
- ServiceResolverInterceptor 371
- services, reporting services on a
  - network 185
- sharing semantics 429
- shutdown, nsutil 205
- simple name 202
- skeletons 15
- Smart Agent
  - about 173
  - and OAD 176, 296
  - availability 177
  - best practices 175
  - bind() 177
  - binding 186
  - checking client existing (heartbeat) 177
  - communication 175
  - connecting on different networks 179
  - connecting to objects with OAD 176
  - cooperation with other agents 175
  - detecting other agents 180
  - disabling 176, 177
  - fault tolerance for objects 183
  - feature summary 6
  - locating 175
  - Location Service 187
  - location service 175
  - multihomed hosts 180
  - Naming Service load balancing 223
  - object name 444
  - objects removed from 306
  - osagent 173
  - OSAGENT\_ADDR environment
    - variable 182
  - OSAGENT\_LOCAL\_FILE file 181
  - point-to-point communication 182
  - properties 62
  - reregistration of objects
    - automatically 177
  - running under multiple domains 178
  - specifying interface usage 181
  - starting 176
  - starting multiple instances 175
  - verbose output 176
- Smart Agent (OSAgent) architecture 6
- specifying IP addresses 183
- square brackets 1
- SSL
  - bidirectional IIOP 441
  - configuring the Naming Service 229
  - configuring VisiNaming 229
  - Naming Service 229
  - VisiNaming 229
- state, determining for an object
  - reference 154
- stateless objects, invoking methods
  - on 183
- status completion, obtaining for system
  - exceptions 94
- Storage interface 261
  - Server Manager 258
- string
  - converting to object references 153
  - mapping 43
- string\_to\_object() method 153
- stringification, using object\_to\_string()
  - method 153
- stringified names 202
- structs. mapping 46
- stub, routines 15
- stubs, generating portable for DII 27, 30
- subnet mask 179, 181
- supplier-consumer communication
  - model 241
- suppliers, connecting to an
  - EventChannel 245
- support, implementation and object
  - activation 7
- SVCnameroot 204
- SVCnameroot property 206
- symbols
  - ellipsis ... 1
  - vertical bar | 1
- system exception, Portable
  - Interceptors 351
- system exceptions
  - BAD\_CONTEXT 451
  - BAD\_INV\_ORDER 451
  - BAD\_OPERATION 451
  - BAD\_PARAM 451
  - BAD\_QOS 451
  - BAD\_TYPECODE 451
  - catching 95
  - COMM\_FAILURE 451
  - CompletionStatus values 94
  - CORBA-defined 93
  - DATA\_CONVERSION 451
  - FREE\_MEM 451
  - handling 94
  - IMP\_LIMIT 451
  - INITIALIZE 451
  - INTERNAL 451
  - INTF\_REPOS 451
  - INV\_FLAG 451
  - INV\_INDENT 451
  - INV\_OBJREF 451
  - INVALID\_TRANSACTION 451
  - mapping Java 58
  - MARSHAL 451
  - narrowing exceptions to 95
  - NO\_IMPLEMENT 451

- NO\_MEMORY 451
- NO\_PERMISSION 451
- NO\_RESOURCES 451
- NO\_RESPONSE 451
- OBJ\_ADAPTOR 451
- OBJECT\_NOT\_EXIST 451
- obtaining completion status 94
- PERSIST\_STORE 451
- SystemException class 93
- TRANSACTION\_MODE 451
- TRANSACTION\_REQUIRED 451
- TRANSACTION\_ROLLEDBACK 451
- TRANSACTION\_UNAVAILABLE 451
- TRANSIENT 451
- UNKNOWN 451

## T

- thread management 7
- thread policies 132
- thread pool dispatch policy 139
- threading
  - dispatch policies and properties 139
  - garbage collection 144
  - listener threads 132
  - properties 143
  - thread policies 132
  - thread pool policy 132
  - thread-per-session policy 135
  - using synchronized block 141
  - using threads 131
  - worker threads 132, 135
- thread-per-session
  - dispatch policy 141
  - implementation 136
- threads
  - multithreading, feature summary 7
  - using 131
- throwing user exceptions 96
- tools
  - administration 10
  - CORBA services 10
  - idl2cpp 15
  - idl2ir 10, 26, 27
  - idl2java 27
  - java2idl 29
  - java2iiop 30
  - oadutil 299
  - oadutil unreg 306
  - osfind 185
  - programming 10
  - vbj 33
- TRANSACTION\_MODE exception 451
- TRANSACTION\_REQUIRED exception 451
- TRANSACTION\_ROLLEDBACK exception 451
- TRANSACTION\_UNAVAILABLE exception 451
- TRANSIENT exception 451
- transmission code set 163
- trigger 188, 190
  - creating 191

- truncatable valuetypes 431
- type
  - Any 338
  - determining for an object reference 153
  - determining instance 153
  - determining sub-type 153
  - extensions 39
- TypeCode class 327
- Typecode object 320
- typecodes, represented in Interface Repository 311
- typedefs, mapping 59
- types
  - DynAny 415
  - mapping 38

## U

- UDP protocol 175
- unbind, nsutil 205
- unions, mapping 46
- UNKNOWN exception 451
- unregistered\_listener 405
- unregistering objects
  - OAD 306
  - using oadutil 306
- untyped object wrappers 386
- UntypedObjectWrapper
  - post\_method 389
  - pre\_method 389
- URL Naming properties 82
- URL Naming Service 433
  - associating a URL with an object 434
  - examples 433
  - InvalidURL exception 435
  - locating an object 435
- user exceptions
  - adding fields to 97
  - adding to fields 97
  - defining 96
  - modifying object to catch 97
  - modifying object to throwing exceptions 96
  - UserException class 96
- utilities
  - idl2ir 314
  - irep 312
  - osagent 19

## V

- valuetypes 425
  - abstract 425, 426
  - abstract interfaces 429
  - base classes 427
  - boxed 429
  - compiling the IDL file 427
  - concrete 425
  - custom 430
  - CustomMarshal interface 430
  - defining 426
  - derivation 425
  - Factories 426

- factories 425, 429
- implementation class 427
- implementing 426
- implementing factories 428
- implementing the Factory class 427
- inheriting valuetype base classes 427
- isomorphic 425
- marshal method 430
- marshalling 430
- null 426
- null semantics 429
- overview 425
- read methods 430
- registering 429
- registering Factory with the ORB 428
- shared 425
- sharing semantics 429
- truncatable 431
- unmarshal method 430
- unmarshalling 430
- write methods 430
- vbj command description 33
- vbmakes, compiling with 19
- vbroker.naming.backingStore 77
- vbroker.naming.cache 217
- vbroker.naming.enableSlave property 225
- vbroker.naming.jdbcDriver 77
- vbroker.naming.loginName 77
- vbroker.naming.loginPwd 77
- vbroker.naming.poolSize 77
- vbroker.naming.propBindOn 222
- vbroker.naming.serverAddresses property 225
- vbroker.naming.serverClusterName property 225
- vbroker.naming.serverNames property 225
- vbroker.naming.slaveMode property 225
- vbroker.naming.url 77
- vbroker.orb.dynamicLibs property 372
- vbroker.orb.enableBiDir property 437
- vbroker.orb.enableServerManager property 263
- vbroker.security.peerAuthenticationMode 441
- vbroker.serverManager.enableOperations property 263
- vbroker.serverManager.enableSetProperty property 263
- vbroker.serverManager.name property 257
- version of product 10, 27, 29, 30, 33
- VisiBroker
  - BOA backward compatibility 443
  - CORBA compliance 9
  - described 6
  - example application 13
  - features of 6
- VisiBroker Interceptors (Interceptors) 367
- VisiBroker Interceptors example 373
- VisiBroker ORB extensions
  - Naming Service 231
  - VisiNaming Service 231
  - VisiBroker ORB, initializing 151
  - VisiNaming
    - bootstrapping 230
    - caching facility 217
    - configuring OpenLDAP 217
    - configuring to use SSL 229
    - method level authorization 230
    - properties for SSL (C++) 229
    - properties for SSL (Java) 229
    - using SSL 229
  - VisiNaming Service
    - adapters 214
    - bootstrapping 206
    - client authentication 228
    - clusters 218
    - configuring 203
    - CosNaming operations supported 205
    - creating a cluster 221
    - default naming context 209
    - examples 232
    - failover 224
    - fault tolerance 225
    - import statements 231
    - initializing in Java 209
    - installing 203
    - load balancing 223
    - master/slave mode 226
    - method level authorization 228
    - nsutil utility 204
    - OMG compliant features 231
    - overview 199
    - pluggable backing store 212
    - properties 75, 209
    - properties file 214
    - sample programs 232
    - security 228
    - shutting down 205
    - starting 203
    - VisiBroker ORB extensions 231
- VISObjectWrapper
  - ChainUntypedObjectWrapper 389
  - UntypedObjectWrapper 389
  - UntypedObjectWrapperFactory 388
- Visual C++ nmake compiler 19

## W

- web naming, associating a URL with an object 433
- web sites, CORBA specification 9
- Windows services
  - console mode 176
  - osagent 176
- words, reserved 38
- worker threads 132
- wstring, mapping 43